

# IMPORTANT SAFETY INSTRUCTIONS



Please read these instructions. All the safety and operating instructions should be read before the appliance is operated.

## Warnings

- To reduce the risk of fire, electric shock or damage to the television, do not expose it to dust, rain or moisture, or place any objects filled with liquids on or near the television.
- Do not place the television in a confined space, ensure that nothing can obstruct the ventilation openings at the rear of the television.

To prevent spread of fire, keep candles or other open flames away from this product at all times



- Dispose of this television and any components including batteries in an environmentally friendly manner. If in doubt, please contact your local authority for details of recycling.

## Safety

- For your safety, this appliance is fitted with a fused moulded 3 pin mains plug. Should the fuse need to be replaced, ensure that any replacement is of the same amperage and approved with the BSI mark.
- The television should be connected to a main socket outlet with a protective earthing connection.
- Never try and replace the mains plug unless you have adequate qualifications and are legally authorised to do so. In the event that a replacement Mains cable is required, contact the manufacturer for a suitable replacement.
- Never use the television if it is damaged in any way.
- Always place the television on a flat level surface avoiding anywhere which may be subject to strong vibration.
- Ensure the television is not placed on top of the power cable as the weight of the television may damage the cable and cause a safety hazard.
- Never place mobile phones, speakers or any other device which may cause magnetic or radio interference with the television. If interference is apparent, move the device causing the interference away from the television.
- To disconnect the apparatus from the mains, please use the all pole mains switch located on the side, underside or rear of the TV. The switch shall remain readily operable.
- Batteries (battery pack or batteries installed) shall not be exposed to excessive heat such as sunshine, fire or the like.
- Install the product at least 5cm from the wall for ventilation.

## Maintenance

- To clean this unit, wipe with a soft, dry cloth. If the surfaces are extremely dirty, use a soft cloth dipped in a soap and water solution or a weak detergent solution.
- Use eyeglass cleaner to remove stubborn dirt from the LCD/LED Screen.
- Never use alcohol, paint thinner or benzene to clean this unit.
- Before using a chemically treated cloth, read the instructions that came with the cloth carefully.



CAUTION: If water or other liquid enters the television through the display panel surface, a malfunction may occur.

## Packaging

- The safest way to transport your item is in the original box/packaging - please save your packaging for this.
- You will need original box/packaging in the event of warranty/service repair or support. We are unable to carry out warranty/service if you are unable to package it correctly.

# IMPORTANT SAFETY INSTRUCTIONS



Please read these instructions. All the safety and operating instructions should be read before the appliance is operated.

## Important Information Regarding Use of Video Games, Computers, Captions or Other Fixed Image Displays

The extended use of fixed image program material can cause a permanent "shadow image" on the LCD panel.

This background image is viewable on normal programs in the form of a stationary fixed image. This type of irreversible LCD/LED panel deterioration can be limited by observing the following steps:

1. Reduce the brightness/contrast setting to a minimum viewing level.
2. Do not display the fixed image for extended periods of time.
3. Turn the power off when not in actual use.

Examples of images that you need to watch out for are as follows (this is not an exhaustive list):

- TV Channel Logos: e.g. Shopping channel logos and pricing displays-especially if they are bright and stationary. Moving or low-contrast graphics are less likely to cause ageing of the screen.
- Time Displays
- Teletext: Do not view a stationary page for long period of time
- TV/DVD Menus: e.g. Listings of DVD disk content
- Pause Mode: Do not leave the TV in pause mode for long periods of time, e.g. When watching DVDs or videos.

Important - Once 'shadow image/screen burn' occurs, it will never disappear and is not repairable under warranty.

## How do I dispose of this product?

UK: Waste electrical products should not be disposed of with household waste. Separate disposal facilities exist. For your nearest facilities, please see [www.recycle-more.co.uk](http://www.recycle-more.co.uk) or in store for details.

ROI: Waste electrical products should not be disposed of with household waste. Separate disposal facilities exist. Check with your Local Authority or retailer for recycling advice.

### Batteries

- Observe the correct polarity when inserting batteries.
- Do not use different types of batteries together or mix old and new batteries.
- Dispose of batteries in an environmentally friendly way.
- Certain regions may regulate the disposal of batteries. Please consult your local authority.



# CONTENTS

Manufacturers Guarantee Information . . . . .	3
Important Safety Instructions . . . . .	4-5
What is included in the box . . . . .	8
Attaching/Detaching the stand and wall mounting . . . . .	9-10
Getting Started - Initial Set Up . . . . .	11
TV Buttons and Input Source Menu . . . . .	12
Remote Control . . . . .	13
Connections . . . . .	14-15
TV Menu Operation . . . . .	16-21
Channel Menu . . . . .	16
Picture Menu . . . . .	17
Sound Menu . . . . .	18
Time Menu . . . . .	19
Feature Menu . . . . .	20
Setup Menu . . . . .	21
PC Operation . . . . .	22-23
7 Day TV Guide . . . . .	24
USB Mode / Media Player . . . . .	25
General Information . . . . .	26-30
Using your TV with a Sky Digital Set Top Box . . . . .	26
Frequently Asked Questions . . . . .	27
Technical Specifications . . . . .	28
Index . . . . .	29

# WHAT IS INCLUDED IN THE BOX

## Accessories

Included with this TV are the following accessories:

1 x User Guide

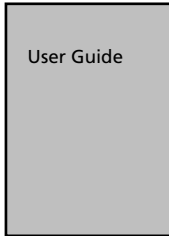

1 x Remote Control



1 x Quick Start Guide

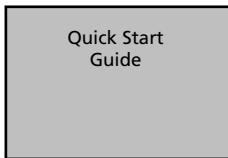

2 x AAA Batteries



1 x TV

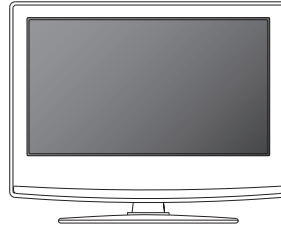

1 x RF Cable



1 x Stand plus screws



Please save your packaging as you will need this in the event of warranty/service repair or support. We are unable to carry out warranty/service if you are unable to package it correctly. The safest way to package your item in the event of warranty/service repair is in it's original box/packaging.

# ATTACHING

## Attaching the Stand

You will need a phillips screwdriver for the assembly.

Place the TV on a flat surface with the screen facing downwards to avoid panel damage

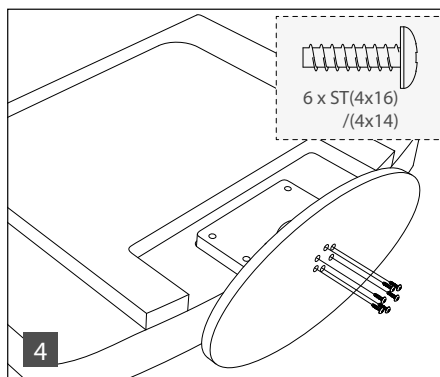
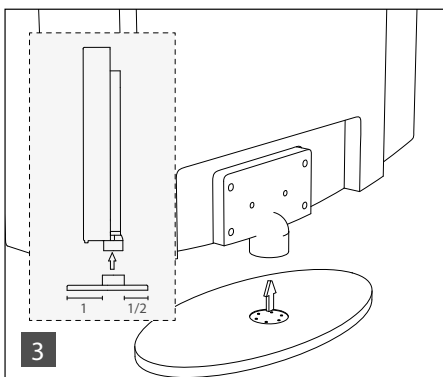
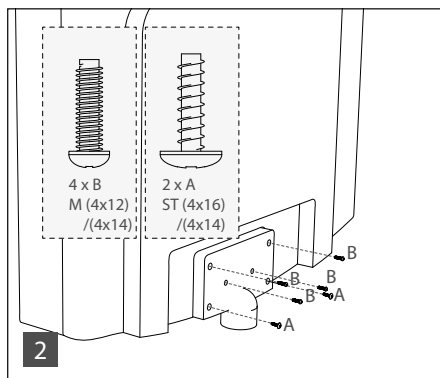
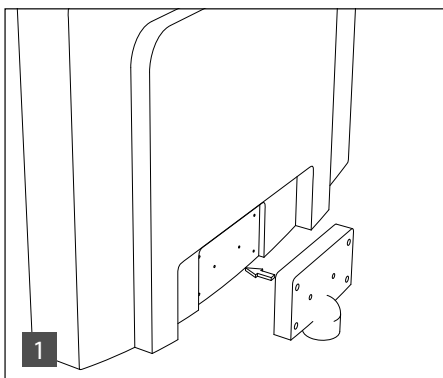

# DETACHING THE STAND

## Detaching the Stand

1) Remove the 6 screws highlighted

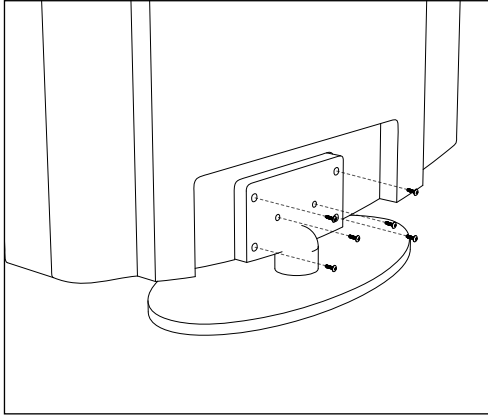

## Wall mounting the TV

1) Remove the four screws highlighted below.

2) The wall mount can now be easily attached to the mounting holes on the rear of the TV. These holes are indicated in the picture below.



For optimum viewing, if wall mounting the TV higher than eye level, the TV should be tilted downwards so that the TV's screen is 'face on'. See fig 1 and 2

**Important** – If wall mounting this TV, only use the screws already provided in the wall mounting holes. Using other screws which are longer could cause irreparable damage to internal parts.

fig 1

INCORRECT

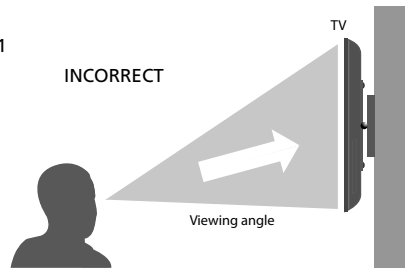

CORRECT

fig 2

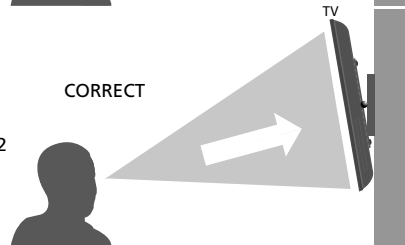

**IMPORTANT** - Before drilling any holes in the wall ensure you are not drilling where there could be any electric wires, water or gas pipes. If in doubt please contact a qualified tradesman.

# GETTING STARTED - INITIAL SET UP

1) Using the RF cable supplied, connect the TV to the TV Aerial wall socket (Fig A)

2) Connect the power cable to the Electrical outlet (Fig B)



3) Switch on the television using the power on/off switch.

4) Insert the batteries supplied into the Remote control and press the Standby button to power on the TV

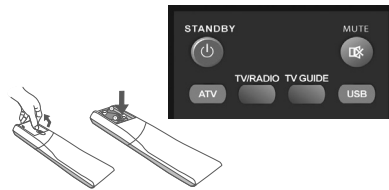
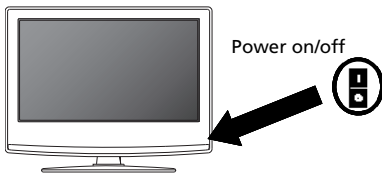

5) You will now be welcomed with the initial set-up screen.  
Ecohome mode: Select this mode for the most energy efficient TV set up\*  
If it does not appear, on the remote control, please press [MENU] then 8-8-8-8 and the menu will appear. Press OK on the remote control and tuning will start.

6) After tuning the following screen will appear.

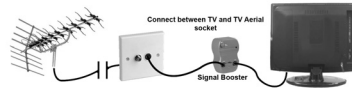
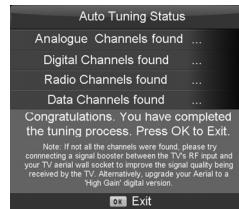

If you are missing channels, the reason for this is likely to be signal strength, you should consider connecting a signal booster and re-tuning the TV.

\*As part of our ongoing development to reduce power consumption, we have added an extra function to this Television called 'Ecohome' (you will see this during the first time installation set up). Power consumption using the Ecohome function is approximately 15% lower than some other modes. The picture brightness is reduced using the Ecohome function. If this function is not suitable for your viewing environment, you can select other modes as necessary. (Please note, 'Professional' mode is for optimum default picture settings, however, power consumption is approximately 15% higher than 'Ecohome' mode)  
Please refer to the user guide section 'Picture settings' in order to change the mode to one that maybe more suitable for your environment. There is also a shortcut button on the remote control called 'P-Mode' should you wish to change to another mode.

# TV BUTTONS & SOURCE MENU

- 1 Volume up and menu right
- 2 Volume down and menu left
- 3 Programme/Channel up and menu up
- 4 Programme/Channel down and menu down
- 5 Displays Menu/OSD
- 6 Displays the input source menu
- 7 Standby Power On/Off

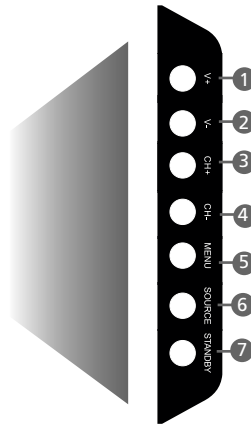
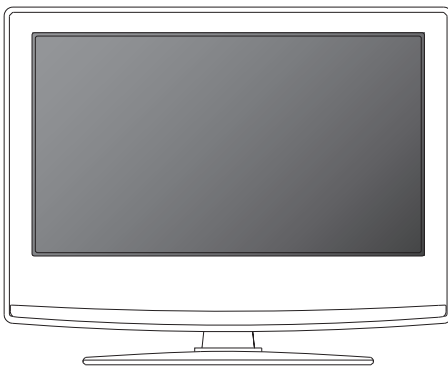

## Choosing Mode Input/Source

To switch between the different input/connections.

A) Using the buttons on the remote control:

- 1) Press [SOURCE/ AV] - The source menu will appear
- 2) Press [V] or [A] to select the input you require.
- 3) Press [OK]

B) Using the buttons on the Television:

- 1) Press [SOURCE]
- 2) Scroll up / down using CH+/ CH- buttons to the input/source you require
- 3) Press Vol+ to change input/source to the one selected.





# REMOTE CONTROL

- 1** STANDBY - Switch on TV when in standby or vice versa  
 MUTE - Mute the sound or vice versa  
 TV/RADIO - Switch to Freeview and switch between TV and radio in Freeview mode  
 TV GUIDE - Opens the 7 Day TV Guide (Freeview mode)  
 ATV - Switch to analogue TV source  
 USB - Switch to USB Source

- 2** S.MODE - Scrolls through sound mode options  
 P.MODE - Scrolls through picture mode options
- ⏮ - To restart the current chapter
  - ⏭ - To advance forward to the next chapter
  - ⏸ - To stop the playback
  - ⏪ - To play in fast rewind mode
  - ⏩ - To play in fast forward mode
  - ⏹ - To play/pause
- } Only operate when a USB key is inserted

- 3** SOURCE/AV - To display the input/source menu  
 INFO - Press once for now/next channel information  
 Press twice for programme information about current programme
- (▲/▼/◀/▶/OK) - Allows you to navigate the on-screen menus and adjust the system settings to your preference  
 MENU - To display OSD menu  
 EXIT - To exit all menus  
 NUMBER BUTTONS - 0 – 9 to select a TV channel directly.  
 ↶ - To return to the previous channel viewed  
 FAV - To display favourites menu

- 4** VOL ▲/▼ - To increase / decrease the sound level  
 SUBTITLE - To switch the dialogue at the bottom of the screen (on/off)  
 ASPECT - To switch the screen between the different picture formats  
 AUDIO - To change the audio language (if available)  
 SLEEP - Press repeatedly to cycle through the sleep options  
 CH ▲/▼ To increase or decrease the channel being watched

- 5** TEXT - Teletext mode - To enter Teletext  
 INDEX - Teletext mode - To display the index page  
 REVEAL - Teletext mode - To reveal or hide the hidden words.  
 DISPLAY - To switch off the screen when listening to radio  
 SIZE - Teletext mode - To change the display size in Teletext mode  
 HOLD - Teletext mode - Hold current page which is displayed



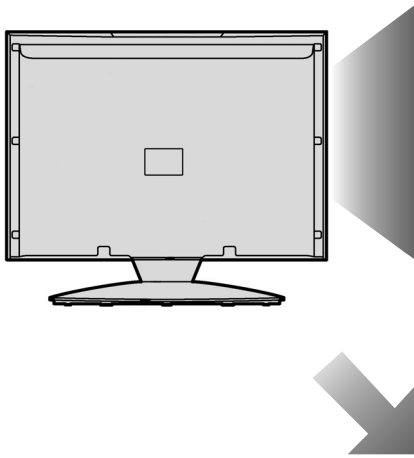

A	USB	USB port
B	HDMI 1	HDMI input
C	HDMI 2	HDMI input
D	HDMI 3	HDMI input
E	VGA(PC)	VGA-PC input
F	VGA(PC) Audio In	3.5mm PC audio input
G	CI CARD IN	Common Interface Card Input
H	SCART	SCART input
I	COAX Audio Out	Digital Coax output
J	COMPONENT (HD)	Component input (YPbPr)
K	VIDEO	Video input
L	R/L (AUDIO)	Video / Component audio input
M	RF IN	RF / TV Aerial Input
N	HEADPHONES	3.5mm Headphone output

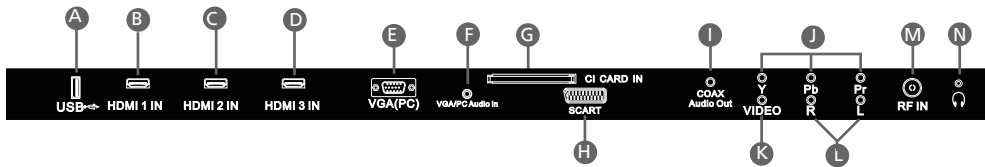

### Connecting a DVD Player/Recorder, Video Recorder or Cable/Satellite Box

TVs Input/Source should be set to SCART

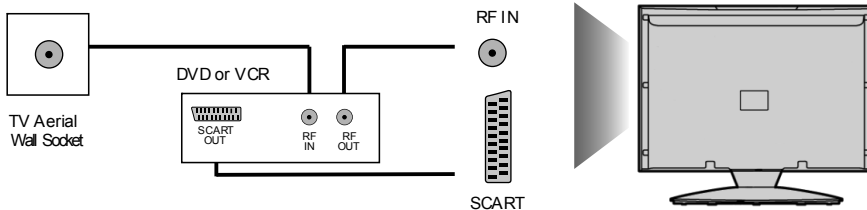

# CONNECTIONS

## Connecting a Camcorder, Camera or Games Console

Source should be set to Video

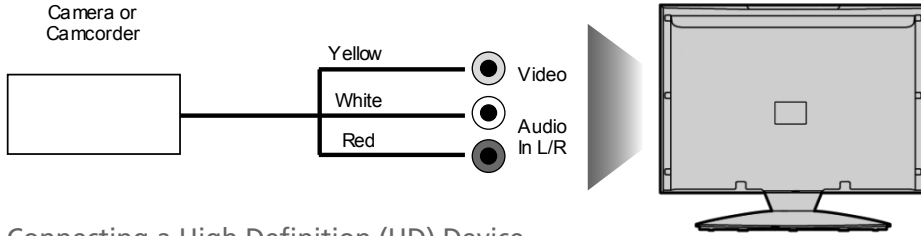

## Connecting a High Definition (HD) Device

Option 1 - via HDMI to HDMI cable

A HDMI cable can output both video and audio and enables you to enjoy digital-quality video and audio with minimal loss of quality.

TVs Input/Source should be set to HDMI.

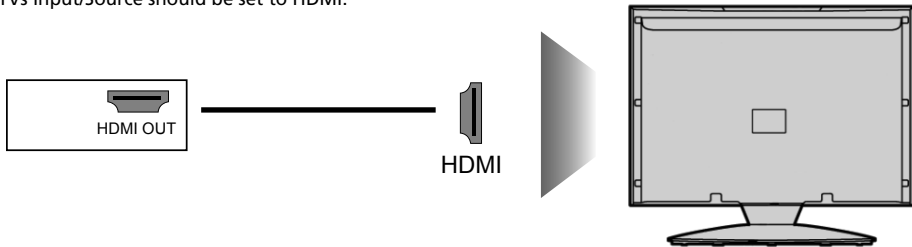

Option 2 - via Component cable

If you are supplied with a cable from the device which has RED, GREEN, BLUE, RED & WHITE connectors you must connect via Component (for picture) and by phono cable (for sound).



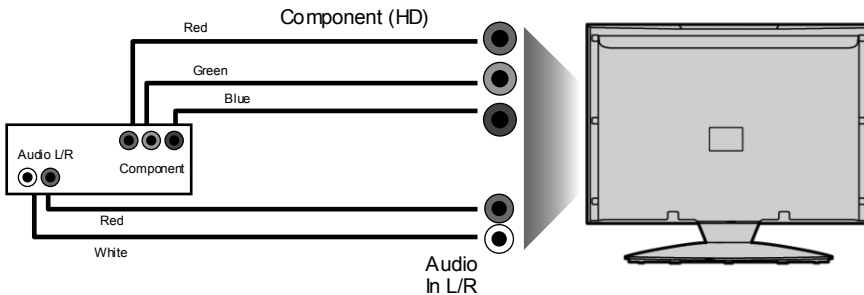

TV Source should be set to Component.

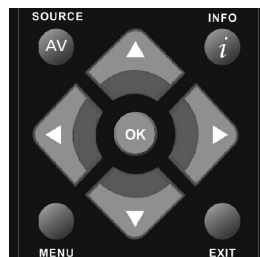
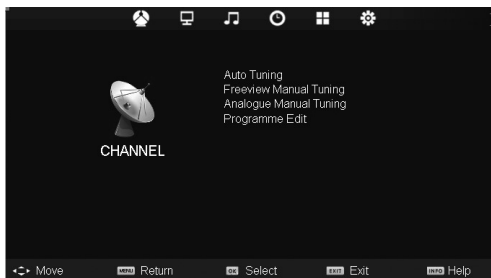

# CHANNEL MENU



To access this menu, press [MENU] button on the remote control. To enter a menu press [OK]

If you wish to make changes to any of the default settings, use the scroll     buttons. To confirm any settings press [OK] button.

To exit this menu at anytime, press [EXIT] button.

**Auto Tuning** - Allows you to retune the television for all digital channels, digital radio stations and analogue channels.

**Freeview Manual Tuning**- Allows you to manually tune your digital signal

**Analogue Manual Tuning** - Allows you to manually tune your analogue signal

**Programme Edit** - Allows you to delete, skip and add favourite channels.



# PICTURE MENU

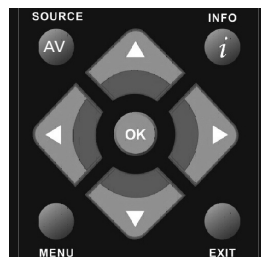

To access this menu, press [MENU] button on the remote control. To enter a menu press [OK]

If you wish to make changes to any of the default settings, use the scroll ▲▼▶◀ buttons. To confirm any settings press [OK] button.

To exit this menu at anytime, press [EXIT] button.

**Picture Mode** - Choose from the following presets

Standard	Default settings
Dynamic	Recommended settings for fast moving pictures
Mild	Set to be lighter in colour and less bright
Personal	Lets you manually alter all the settings
Ecohome	15% less power consumption

**Contrast** - Switch the balance between black and white

**Brightness** - Increase or decrease the brightness of the picture

**Colour** - Increases the colour from black and white

**Tint** - Lets you increase or decrease the level of tint within the picture

**Sharpness** - Increase or decrease the sharpness of the picture

**Colour Temperature** - Choose from the following presets

Normal	Default settings
Warm	Increases red within the picture
Cool	Increases blue within the picture

**Noise Reduction** - Choose from the following presets



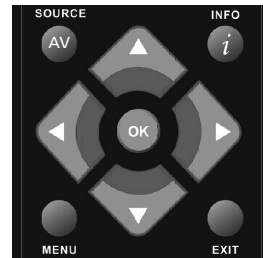
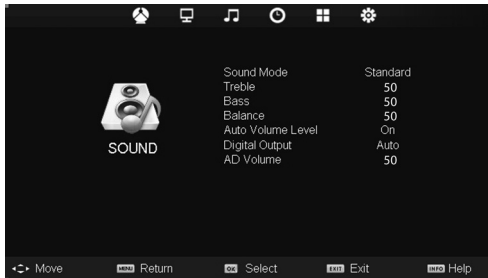

Off	Turns noise reduction off
Low	Minor system adjustment
Middle	Medium system adjustments
High	Maximum system adjustments
Default	Default settings

**Tip:** If you do not press any buttons for 10 seconds, the menu will automatically exit. You can change the length of time before the menu exits automatically - see 'Menu Duration' section.

# SOUND MENU



To access this menu, press [MENU] button on the remote control. To enter a menu press [OK]

If you wish to make changes to any of the default settings, use the scroll     buttons. To confirm any settings press [OK] button.

To exit this menu at anytime, press [EXIT] button.

**Sound Mode** - Choose from the following presets

Standard	Default settings
Music	Emphasises music over voices
Movie	Provides live and full sound for movies
Personal	Selects your personal sound settings
Sports	Emphasises sound for sports

**Tip:** Treble and bass levels can only be adjusted when the sound mode 'Personal' is selected.

**Treble** - To adjust the amount of high frequency within the sound

**Bass** - To adjust the amount of low frequency within the sound

**Balance** - To switch the sound between the left and right speakers

**Auto Volume Level (AVL)** - When 'on' is selected, the volume will stay at a constant level regardless of input/source

**Digital Output** - This is the digital COAX Audio output. Choose from the following options:

Off	Off
Auto	Selects the best settings automatically
PCM	Select this option if you are connecting to a Stereo Hi-fi via coax cable (Pulse-code modulation (PCM) is a digital representation of an analogue signal)

**AD Volume** - Increase or decrease the overall volume

# TIME MENU

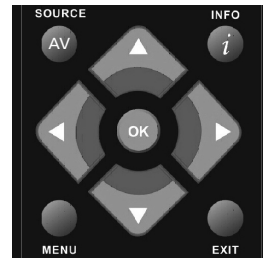
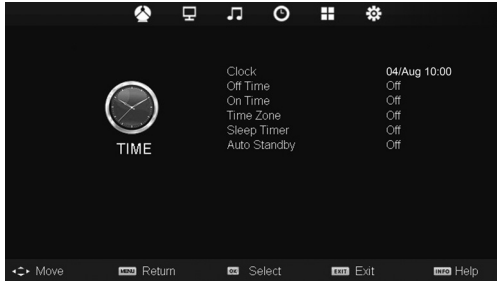

To access this menu, press [MENU] button on the remote control. To enter a menu press [OK]

If you wish to make changes to any of the default settings, use the scroll buttons. To confirm any settings press [OK] button.

To exit this menu at anytime, press [EXIT] button.

**Clock** - Shows the date and time

**Off Time** - Allows you to set a specific time for your TV to turn off

**On Time** - Allows you to set a specific time for your TV to turn on, the channel it will then display, the source it will be on and also the volume. This function can then be toggled to repeat every day or a certain day.

**Time Zone** - Change your current time zone



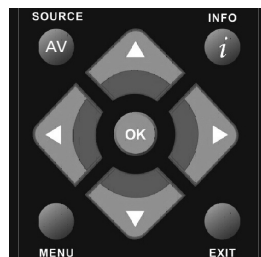
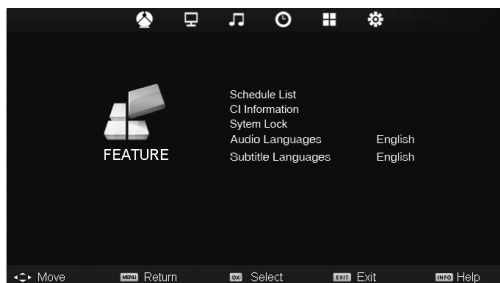

**Sleep Timer** - Lets you set the sleep timer so the television automatically switches off after a set amount of time. Off -> 10min -> 20min -> 30min -> 60min -> 90min -> 120min -> 180min -> 240min

**Auto standby** - Toggle the Function on and off

## FEATURE MENU



To access this menu, press [MENU] button on the remote control. To enter a menu press [OK]



If you wish to make changes to any of the default settings, use the scroll     buttons. To confirm any settings press [OK] button.

To exit this menu at anytime, press [EXIT] button.

Schedule List - Lists your programme reminders

CI Information - Pay per view services require a "smartcard" to be inserted into the TV.

If you subscribe to a pay per view service the provider will issue you with a 'CAM' and a "smartcard". The CAM can then be inserted into the COMMON INTERFACE PORT (CI Card In).

System Lock - Allows you to lock or unlock the menu. You will be asked to enter a 4 digit password use the  button to quit the password input. Use the  button to clear. Default password is 0000



# SETUP MENU

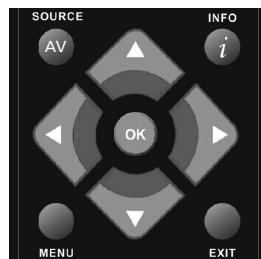
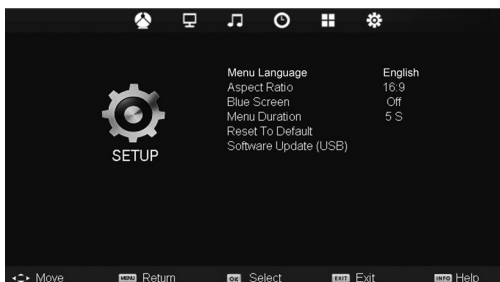

To access this menu, press [MENU] button on the remote control. To enter a menu press [OK]

If you wish to make changes to any of the default settings, use the scroll buttons. To confirm any settings press [OK] button.

To exit this menu at anytime, press [EXIT] button.

Menu language - Allows you to change the language of the menu

**Aspect Ratio** - Within the UK the picture format varies depending on the channel/broadcast. There are a number of different options to best meet your needs

**Auo**  
Automatically displays the best picture format. So the picture is in the correct position. May have black lines At the top/bottom and/or sides.

**Original**  
Will display the picture from the broadcaster without any change

**Zoom**

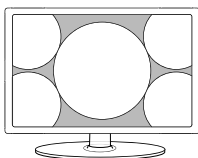

The picture is the correct proportion but zoomed in to fill the screen

4:3

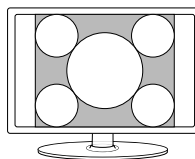

Displays the 4:3 picture in its original size. Side bars are shown to fill the 16:9 screen

16:9

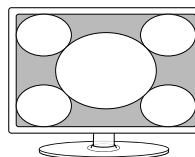

Fills the screen with a regular 16:9 signal. 4:3 picture will be stretched to fill the screen.

14:9

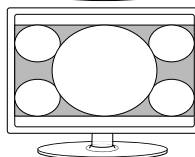

Displays the 14:9 picture in the correct proportion. As a result side bars are shown on the screen

**Blue Screen** - Changes the background when there is no input between clear and a blue background (Only available on some sources)

**Menu Duration** - Lets you adjust the amount of time the On Screen Menu stays on the screen before disappearing

**Reset to default**

Reset Menu System - This resets the menus to factory settings.

Reset TV Channels - This clears all the TV channels from the television.

**Software Update (USB)** - From time to time we may release new firmware to improve the operation of the television (available to download). This menu lets you install the new software/firmware onto the television. Further details of how to do this will be issued with the firmware. Contact the helpline or refer to the 'product support' section of the website.

# USING THE TELEVISION AS A COMPUTER MONITOR

**IMPORTANT** – Before connecting the computer to the television you must ensure the computer settings are correct for the television. You **MUST** do this using your old monitor.

How to set up for Windows XP & Windows Vista (connecting via VGA cable to the TV)

- 1) Switch on your computer
- 2) When finished booting up right click your mouse anywhere on the screen
- 3) Left click your mouse on Properties/Personalise



XP Screen

VISTA Screen



XP Screen

VISTA Screen

- 4) Left click your mouse on Setting/Display Settings. Ensure the screen resolution is set to what is shown in the technical specifications section toward the rear of this user guide. To correct the resolution to that of the television move the slider.
- 5) Left click your mouse on Advance/Advanced Settings and left click on Monitor



XP Screen

VISTA Screen



XP Screen

VISTA Screen

- 6) Left click on the drop down for Screen refresh rate and select 60 Hertz, if you experience picture noise or 'flickering', select 50 hertz or 70 hertz.

- 7) Click on Apply, then click Yes and the settings will be saved.

- 8) Now switch off your computer and connect the television (as shown)

- 9) Switch on the TV, select the input/source to VGA/PC and re-start your PC.

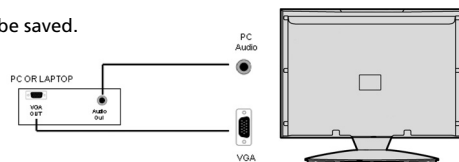

### Connecting a Laptop

In addition to the above if you are connecting a laptop to the television you will also need to activate the VGA connection on the laptop. This can vary based on the brand of laptop you have, on many brands/models, it is as per below.

- 1) Connect the laptop to the television
- 2) On the Laptop push buttons  
The screen will now switch to the television.

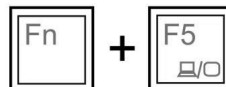

## PC SETTINGS

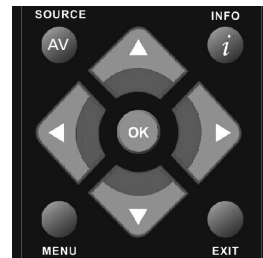
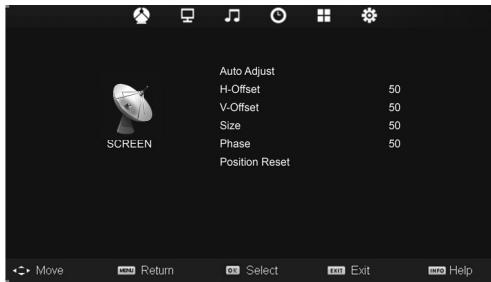

To access this menu, press [MENU] button on the remote control. To enter a menu press [OK]

If you wish to make changes to any of the default settings, use the scroll ▲▼▶◀ buttons. To confirm any settings press [OK] button.

To exit this menu at anytime, press [EXIT] button.

**Auto Adjust** - Lets you automatically configure the television to be used as a computer monitor

**H Offset** - Changes the horizontal position of the picture

**V Offset** - Changes the vertical position of the picture

**Size** - increase picture size

**Phase** - To adjust delay time of phase in order to reduce the noise of picture

**Position Reset** - Changes back to the original settings

**Tip:** If the computer is left in-active for a period of time, the television will switch into a 'sleep' state (the screen will power off to save power). To switch back on press the standby button.

# 7 DAY TV GUIDE

TV Guide is available in Digital TV mode. It provides information about forthcoming programmes (where supported by the freeview channel). You can view the start and end time of all programmes and on all channels for the next 7 days and set reminders.

1) Press [TV GUIDE]. The following 7 Day TV Guide will appear.

## 7 Day TV GUIDE

**10 Years Younger: The Challenge**  
 Season 2  
 Support worker Janice Cassidy's lifestyle of long working hours and a penchant for tanning has taken its toll, while the stress of bringing up two daughters and heavy smoking has affected interior designer Shere Morady. Surgeon Jan Stanek and the team set out to provide

04 Aug 2010 10:42

BBC1	05:00-06:00	10 Years Younger: The Challenge
BBC2	06:00-06:30	The Simpsons
ITV1	06:30-07:00	Hollyoaks
Channel 4	07:00-08:00	Channel 4 News
five	08:00-09:00	How to Look Good Naked
BBC3	09:00-10:00	Newlyweds: The One Year Itch
BBC4	10:00-11:15	Big Brother
ITV2	11:15-11:45	The Big Bang Theory

Remind
Prev Day
Next Day

Move View
Display

2) Navigate through the menu using ▲▼▶◀

You can now:

Set a reminder by pressing GREEN

View a previous day by pressing YELLOW

View the next day by pressing BLUE

3) Press [EXIT] to exit the 7 day TV Guide.

# USB MODE / MEDIA PLAYER

USB mode offers playback of various different types of content that you have saved on your USB Memory Stick.

On switching to USB source the above menu screen will appear. The content will be divided into Photo, Music, Movie and Text based on file type.

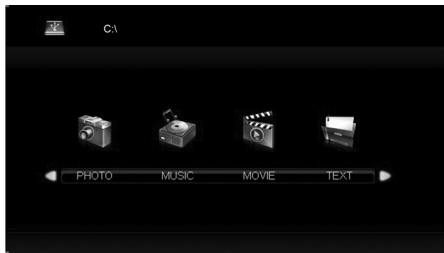

1) You can navigate through the menus using the scroll ▲▼▶◀ buttons. To confirm the item you wish to play/view press [OK] button.

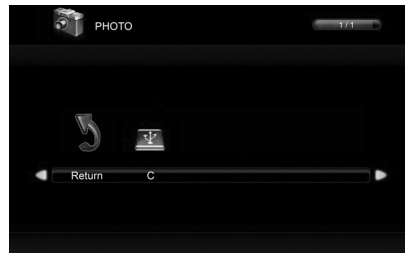

2) Select the drive you require. (If your drive only has 1 partition you will only see 1 item).



3) You can now access the item. Press OK to view.

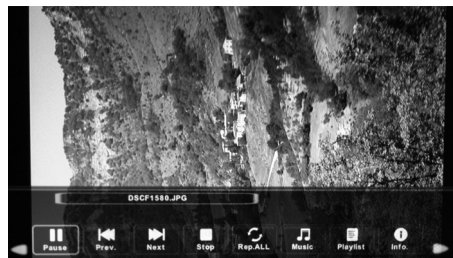

4) While viewing you control the item using



or by pressing ( i ) and using ▲▼▶◀ and (OK)

## USING YOUR TV WITH A SKY DIGITAL SET TOP BOX

### Option 1) Connecting your TV to your Sky box (when both the TV and Sky Box are located in the same room)

Depending on your Sky Box & TV model, connect either by SCART or HDMI cables (available separately)

If connecting by SCART, select the 'Input source' on the TV as SCART.

If connecting by HDMI, select the 'Input source' on the TV as HDMI (if the TV has more than 1 HDMI port, ensure you select the input source to match the HDMI numbered port on the rear of the TV)

If you wish to use your Sky remote to operate the TV's functions, you will need a Sky remote control (Revision 9 or later) and you will need to programme a 4 digit code into it. See bottom of this page.

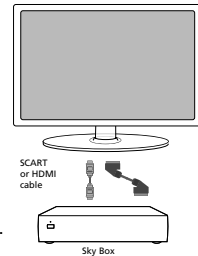

### Option 2) Connecting your TV to your Sky box (when your Sky box is located in a different room to the TV)

Please note, if you are adding a 'Magic Eye/TV Link' to your system so that you can use your Sky remote control to change the Sky channel in the room where the 2nd TV is located, please refer to the instructions included with the TV link/magic eye in order to ensure the RF or RF2 output on your Sky box is powered on. (The red LED light on the TV link/magic eye will light up if the RF / RF2 output is correctly set up) If you do not have the instructions that came with the TV link/magic eye, instructions on how to do it can be found on our web site.

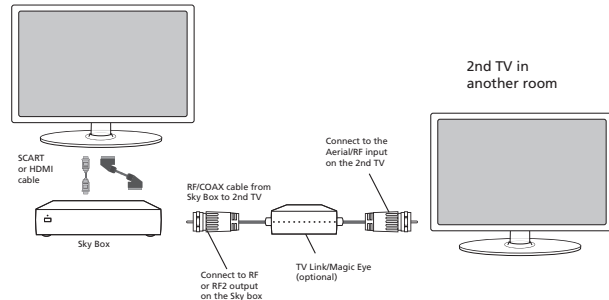

- 1) To tune the TV to the Sky box, on the 2nd TV, select the 'Analogue' input source.
- 2) Select the channel that you wish to store the Sky box/channel on. (If you do not use channels 1-5 because you no longer have analogue terrestrial channels after digital switchover, you may choose to select channel 1 to store the Sky box/channel, if you still have and use analogue channels 1-5, you may for example decide that channel 6 is the best option for you)
- 3) Press the corresponding number on the remote control to select the desired analogue channel chosen as per point 2 above.
- 4) On the TV remote control, press Menu. Now navigate through the menus to select Manual Tuning or Analogue Manual tuning (refer to the Tuning/Channel menu section of this user guide if necessary)
- 5) Manually tune in the channel (usually, the Sky box is at a frequency between 800Mhz and 850Mhz) once the Sky box/channel is found, press 'OK' to store it.

If you wish to use your Sky remote to operate the TV's functions, you will need a Sky remote control (Revision 9 or later) and you will need to programme a 4 digit code into it. See below.

#### Using a Sky Remote or a Universal Remote to operate your TV

**Sky Remote Control**, If you wish to use your Sky remote to operate the basic functions of your TV, you need to programme a 4 digit code into it. Please note. you will need the latest Sky Revision 9 remote control as this is the only version that includes the latest software/firmware necessary to operate this model of TV. All codes can be found on our website. If you wish to upgrade/replace your existing Sky remote control to the latest version, you can do so on our web site.

**Universal Remote Control**, If you wish to use a Universal remote control to operate your TV, please refer to the web site for a full list of codes. (Please note we only have codes for One for All branded remote controls, if you have an alternative brand of Universal remote, please refer to the manufacturer for the code.)

# FREQUENTLY ASKED QUESTIONS

General	I would like to have louder sound by connecting additional speakers	Subject to the TV model and connections, it is possible to connect the TV to an external amplifier or surround sound (subject to connections/inputs on the device) as follows:- 1) Connect a COAX cable* from the TV's COAX output to your amplifier/surround systems COAX input 2) Connect a 3.5mm jack to L/R phono cable* from the TV's headphone socket (where fitted) to your amplifier/surround sound L/R input. Please note sound to the TV's speakers will be disabled. 3) On selected models, it may be possible to connect a SCART input/output* switch with an additional L/R Phono cable* to the TV's SCART socket and to the L/R Phono Input of your amplifier/surround sound. Please note due to copyright laws it is not possible to output video/sound from the TV on certain sources, i.e. HDMI, DVD etc. *cables and switches mentioned are available to purchase separately from your retailer.
General	Why are some options in the menu unavailable and greyed out	Some options are only available in certain sources, i.e. HDMI, PC/VGA. They are unavailable in the other sources where they have no affect.
General	Can I stop my TV turning off after 4hrs?	Yes 1) In the picture settings menu, de-select Eco-home 2) In the time settings menu, scroll down to Auto standby and select OFF
TV	I have tuned in Digital TV but I am not receiving any or all of the channels and/or the channels I receive are breaking up	1) Check you are in an area that can receive Freeview. Visit <a href="http://www.freeview.co.uk">www.freeview.co.uk</a> . 2) Check you are using an aerial that is able to receive a good digital signal. In most cases, you will need an outdoor digital hi-gain/wideband aerial. In areas that have excellent Freeview coverage, you may be able to use a loft type aerial but it is highly likely that you will also need to connect a booster between the back of the TV and the TV aerial wall socket. Unfortunately, to receive a good enough digital signal, it is not possible to use a portable/indoor type aerial. This may change once the analogue signal is switched off in 2012 and the Digital signal strength is increased.
TV	I have re-tuned my television but when I switch it off it is not storing the channels	Complete a first time installation, please refer to the set-up menu section of the manual for how to do this
VCR/DVD Recorder	I have connected the TV to my VCR or DVD Recorder via SCART but it is not recording	In addition to connecting via SCART, you should connect the aerial cable from the wall socket to your VCR/DVD Recorder and another aerial cable from the VCR/DVD Recorder to the TV
Game Consoles	I have connected my PS3 to the TV via HDMI, but I am not receiving any pictures or sound on my Television	1) Ensure the TV's source is on HDMI 2) Check your settings on your PS3 are as per the PS3 instruction manual
Game Consoles	I have connected my Xbox 360 to the TV via Component Cables (Red, Green & Blue) but I am not receiving any sound	Component cables only provide HD Pictures. For the sound you will need to connect the Red & White audio cables on the Xbox to the Red & White phono inputs on the rear of the TV. Please refer to the 'Connections' pages.
USB Mode	I have inserted a USB Memory Key, but the TV does not recognise it	Ensure the USB Memory Key is formatted to type FAT32.
USB Mode	Can I use a USB portable hard drive with my TV?	If you wish to use a portable hard drive larger than 32GB, please note that it must be formatted to the FAT32 file system in order to operate on this TV. Windows XP/Vista computers are only capable of formatting up to 32GB, therefore, you will need a software programme/utility to format larger hard drives. Please refer to the web site for more information.
System Lock	I have changed the password on the television and now forgotten it	There is a master password of 4711, to gain access to the TV menu and reset the normal password

# TECHNICAL SPECIFICATION

Model	46/58G-GB-1B-FTCU-UK
Screen size (diagonal)	46"/ 117cm
Resolution	1920x1080
Contrast Ratio	5000:1
Brightness cd/m2	400
PC RGB	Yes
RF	75 ohm Antenna / PAL-SECAM
Video Inputs	1 x SCART, 1 x Video, 1 x Component (YPbPr - 1080p), 3 x HDMI (up to 1080p)
Sound Inputs	1 x 3.5mm jack for PC audio input, 1 x pair RCA Audio input shared for Video and YPbPr (component)
Sound Outputs	1 x Coax Audio output , 1 x 3.5mm headphone jack
Sound power, watts (RMS)	2 x 9W
Voltage and power consumption	110-240V 50/60Hz 137/230 W (eco-home/max) in standby less than 0.5W
Dimensions including stand (mm)	1105W x 737H x 272D mm
Net weight (Kgs)	21.6kg

## Compatible files in USB Mode

Media	File Ext.	Codec		
		Video	Audio	
Movie	.mpg	Mpeg-1, Mpeg-2	MP3, WMA	Max Resolution: 1920x1080 Max Data rate: 40Mbps
	.avi	Xvid, MJPEG, MPEG-4 SP/ASP		
	.ts	Mpeg-2		Max Resolution: 1920x1080 Max Data rate: 40Mbps
	.mov	Mpeg-4 SP/ASP		
	.dat	Mpeg-1		Max Resolution: 1024x768 Max Data rate: 40Mbps
	.mp4	Mpeg-1, Mpeg-2		
	.vob	Mpeg-2		
Music	.mp3	-	MP3	Sample Rate 16K-48KHz Bit rate: 320Kbps
	.wma	-	WMA	
Picture	.jpg	Progressive JPEG		Max Resolution: 1024x768
	.jpeg	Baseline JPEG		Max Resolution: 8192x8192
	.bmp	BMP		Max Resolution: 6500x6500



# INDEX

Attaching the stand .....	9	Source Menu.....	12
Aspect Ratio.....	21	System Lock .....	20
Auto Configuration of screen (PC).....	23	Technical Specifications .....	28
Auto Tuning.....	16	Treble .....	18
Auto Volume Level .....	18	TV buttons .....	12
Balance .....	18	TV Guide .....	24
Bass .....	18	USB Mode / Media Player .....	25
Blue Screen .....	21	Using the television as a computer monitor .....	22
Brightness .....	17	Vertical Position (PC) .....	23
Clock.....	19	Wall mounting .....	9
Colour .....	17	What is included in the box .....	8
Colour Temperature .....	17		
Common Interface .....	20		
Connections.....	14-15		
Contrast .....	17		
Detaching the base/stand.....	10		
Digital Output .....	18		
First Time Installation .....	11		
Frequently Asked Questions.....	27		
Getting Started.....	11		
Horizontal Position (PC).....	23		
Language .....	21		
Manual Search.....	16		
Noise Reduction .....	17		
Operating the TV with a universal or Sky (BSKYB) remote control .....	26		
Phase (PC) .....	23		
Picture Mode .....	17		
Remote control .....	13		
Reset to default.....	21		
Sharpness .....	17		
Sleep Timer .....	19		
Sound Mode .....	18		







UMC/MAN/0014

