

SONY®

3-273-475-12(1)

U

# LCD Digital Colour TV



## Operating Instructions

⚠ Before operating the TV, please read the "Safety information" section of this manual. Retain this manual for future reference.

<http://www.sony.net/>

**KDL-40P30xx**  
**KDL-37P30xx**  
**KDL-32P30xx**  
**KDL-26P30xx**  
**KDL-26S30xx**  
**KDL-26S28xx**

**KDL-40U30xx**  
**KDL-37U30xx**  
**KDL-32U30xx**  
**KDL-26U30xx**  
**KDL-26T28xx**  
**KDL-26T26xx**



327347512

3-273-475-12(1)

U

**KDL-40P30xx**  
**KDL-37P30xx**  
**KDL-32P30xx**  
**KDL-26P30xx**  
**KDL-26S30xx**  
**KDL-26S28xx**

**KDL-40U30xx**  
**KDL-37U30xx**  
**KDL-32U30xx**  
**KDL-26U30xx**  
**KDL-26T28xx**  
**KDL-26T26xx**

# BRAVIA

Printed in EU



© 2008 Sony Corporation



For useful information about Sony products

<http://www.sony-europe.com/myproduct/>

# NOTICE FOR CUSTOMERS IN THE UNITED KINGDOM

A moulded plug complying with BS1363 is fitted to this equipment for your safety and convenience. Should the fuse in the plug supplied need to be replaced, a 10 AMP fuse approved by ASTA or BSI to BS 1362 (i.e., marked with  or ) must be used.

When an alternative type of plug is used it should be fitted with a 10 AMP FUSE otherwise the circuit should be protected by a 10 AMP FUSE at the distribution board. If the plug supplied with this equipment has a detachable fuse cover, be sure to attach the fuse cover after you change the fuse. Never use the plug without the fuse cover. If you should lose the fuse cover, please contact your nearest Sony service station.

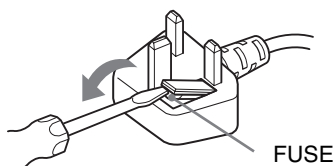

## How to replace the fuse

Open the fuse compartment with a blade screwdriver, and replace the fuse.

## Introduction

Thank you for choosing this Sony product. Before operating the TV, please read this manual thoroughly and retain it for future reference.

## Disposal of the TV set



### Disposal of Old Electrical & Electronic Equipment (Applicable in the European Union and other European countries with separate collection systems)

This symbol on the product or on its packaging indicates that this product shall not be treated as household waste. Instead it shall be handed over to the applicable collection point for the recycling

of electrical and electronic equipment. By ensuring this product is disposed of correctly, you will help prevent potential negative consequences for the environment and human health, which could otherwise be caused by inappropriate waste handling of this product. The recycling of materials will help to conserve natural resources. For more detailed information about recycling of this product, please contact your local Civic Office, your household waste disposal service or the shop where you purchased the product.

## Notice for Digital TV function

- Any functions related to Digital TV (**DVB**) will only work in countries or areas where DVB-T (MPEG2) digital terrestrial signals are broadcasted. Please confirm with your local dealer if you can receive a DVB-T signal where you live.
- Although this TV set follows DVB-T specifications, compatibility with future DVB-T digital terrestrial broadcasts cannot be guaranteed.
- Some Digital TV functions may not be available in some countries.

The manufacturer of this product is Sony Corporation, 1-7-1 Konan Minato-ku Tokyo, 108-0075 Japan. The Authorized Representative for EMC and product safety is Sony Deutschland GmbH, Hedelfinger Strasse 61, 70327 Stuttgart, Germany. For any service or guarantee matters please refer to the addresses given in separate service or guarantee documents

## Trademark information

- **DVB** is a registered trademark of the DVB Project
- Manufactured under license from BBE Sound, Inc. Licensed by BBE Sound, Inc. under one or more of the following US patents: 5510752, 5736897. BBE and BBE symbol are registered trademarks of BBE Sound, Inc.
- Manufactured under license from Dolby Laboratories. "Dolby" and the double-D symbol  are trademarks of Dolby Laboratories.
- HDMI, the HDMI logo and High-Definition Multimedia Interface are trademarks or registered trademarks of HDMI Licensing LLC.



- The illustrations used in this manual are of the KDL-26S28xx unless otherwise state.
- The "xx" that appears on the model name, corresponds to two numeric digits related to colour variation.

# Table of Contents

## Start-up Guide

4

Safety information .....	8
Precautions .....	9
<b>Overview of the remote .....</b>	<b>10</b>
<b>Overview of the TV buttons and indicators .....</b>	<b>11</b>

## Watching TV

Watching TV .....	12
Checking the Digital Electronic Programme Guide (EPG) <b>DVB</b> .....	14
Using the Digital Favourite list <b>DVB</b> .....	16

## Using Optional Equipment

Connecting optional equipment.....	17
Viewing pictures from connected equipment .....	18
Using HDMI control .....	19

## Using MENU Functions

Navigating through menus .....	20
Picture Adjustment menu .....	21
Sound Adjustment menu.....	23
Features menu .....	25
Set-up menu.....	27
Digital Set-up menu <b>DVB</b> .....	30

## Additional Information

Specifications .....	32
Troubleshooting .....	34

**DVB** : for digital channels only

# Start-up Guide

## 1: Checking the accessories

Remote RM-ED009 (1)

Size AA batteries (R6 type) (2)

Stand (1)

Screws for stand (3)

Screws for stand (4) (KDL-40P30xx, KDL-37P30xx, KDL-40U30xx, KDL-37U30xx)

### To insert batteries into the remote

Push and lift the cover to open.

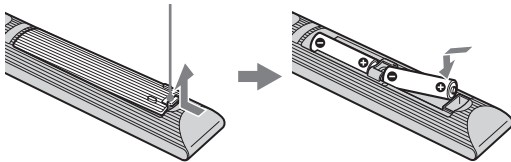

- Observe the correct polarity when inserting batteries.
- Do not use different types of batteries together or mix old and new batteries.
- Dispose of batteries in an environmentally friendly way. Certain regions may regulate disposal of batteries. Please consult your local authority.
- Handle the remote with care. Do not drop or step on it, or spill liquid of any kind onto it.
- Do not place the remote in a location near a heat source, a place subject to direct sunlight, or a damp room.

## 2: Attaching the stand

- 1 Open the carton box and take out the stand.

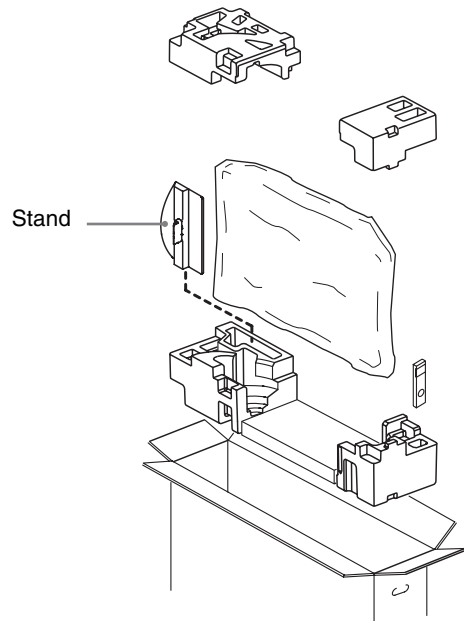

- 2 Release the protection bag and take out the TV set.

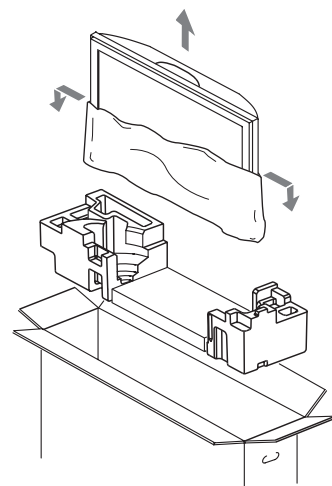

**3** Place the TV set on the stand. Take care not to interfere with cables.

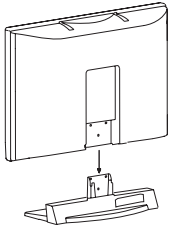

**4** Take out the screws from the accessory bag.

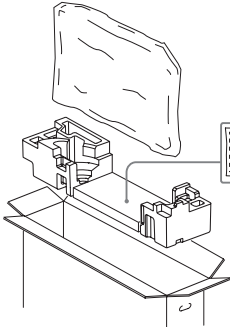

KDL-32P30xx  
KDL-26P30xx  
KDL-32U30xx  
KDL-26U30xx  
KDL-26S30xx  
KDL-26S28xx  
KDL-26T28xx  
KDL-26T26xx

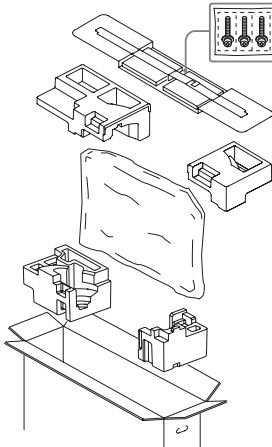

KDL-40P30xx  
KDL-37P30xx  
KDL-40U30xx  
KDL-37U30xx

**5** Fix the TV to the stand using the supplied screws.

KDL-40P30xx  
KDL-37P30xx  
KDL-40U30xx  
KDL-37U30xx

KDL-32P30xx  
KDL-26P30xx  
KDL-32U30xx  
KDL-26U30xx  
KDL-26S30xx  
KDL-26S28xx  
KDL-26T28xx  
KDL-26T26xx

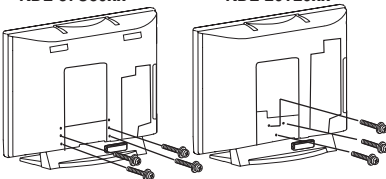

If using an electric screwdriver, set the tightening torque at approximately 2 N·m (20 kgf·cm)

### 3: Connecting an aerial/VCR/ DVD recorder

Connecting an aerial only

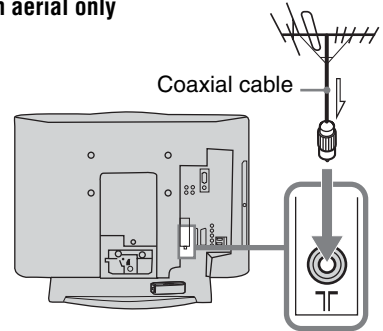

Connecting an aerial/VCR/ DVD recorder

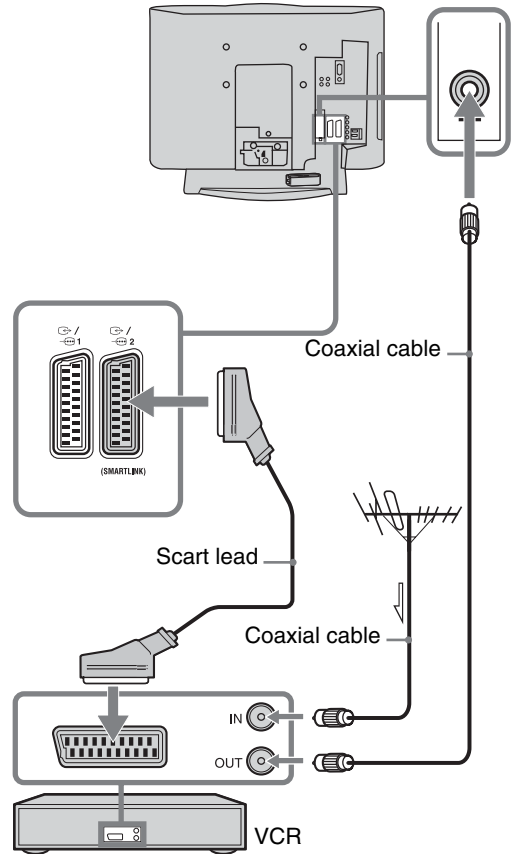

Continued

## 4: Preventing the TV from toppling over

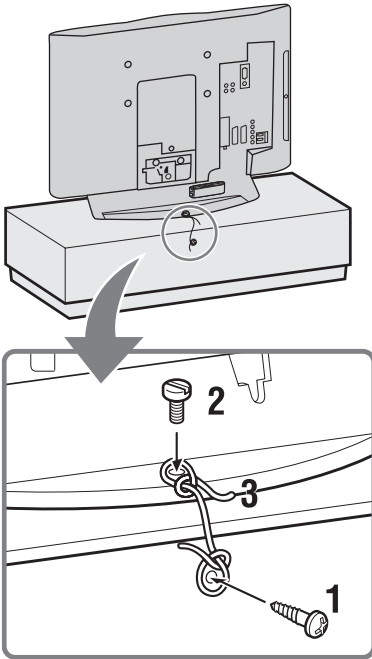



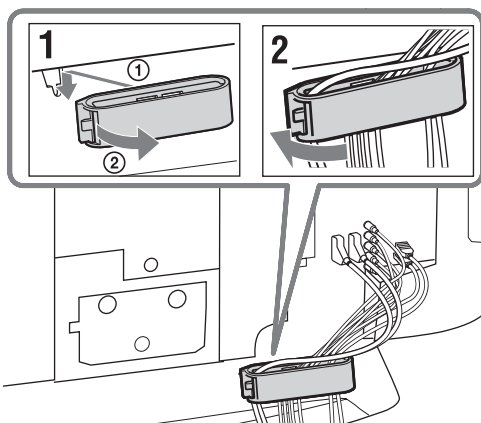

- 1 Install a wood screw (4 mm in diameter, not supplied) in the TV stand.
- 2 Install a machine screw (M5 x 12, not supplied) into the screw hole of the TV.
- 3 Tie the wood screw and the machine screw with a strong cord.

## 5: Bundling the cables

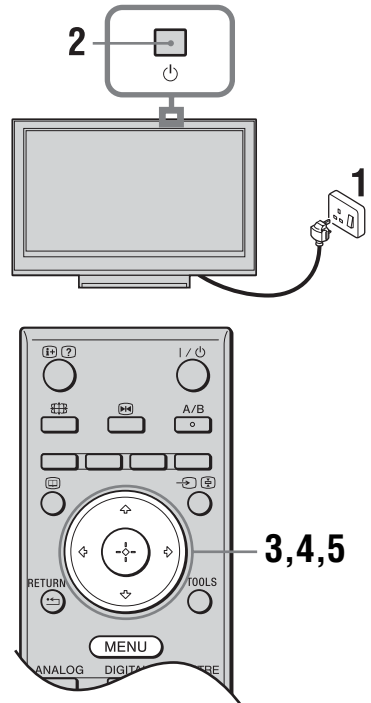

## 6: Selecting the language, country/region and location



- 1 Connect the TV to your mains socket (220-240V AC, 50Hz).
- 2 Press  on the TV (top side).  
When you switch on the TV for the first time, the Language menu appears on the screen.
- 3 Press  to select the language displayed on the menu screens, then press .

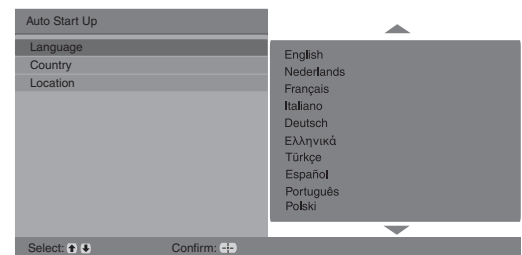

- 4 Press  $\uparrow/\downarrow$  to select the country/region in which you will operate the TV, then press  $\oplus$ .



If the country/region in which you want to use the TV does not appear in the list, select “-” instead of a country/region.

- 5 Press  $\uparrow/\downarrow$  to select the location type in which you will operate the TV, then press  $\oplus$ .



This option selects the initial picture mode appropriate for the typical lighting condition in these environments.

## 7: Auto-tuning the TV

- 1 Before you start auto-tuning the TV, insert a pre-recorded tape into the VCR connected to the TV (page 4) and start play back. The video channel will be located and stored on the TV during auto-tuning. If no VCR is connected to the TV, skip this step.

- 2 Press  $\oplus$ .

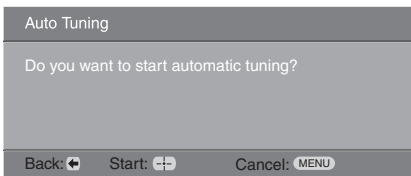

The TV starts searching for all available digital channels, followed by all available analogue channels. This may take some time, so do not press any buttons on the TV or remote while proceeding.

### If a message appears for you to confirm the aerial connection

No digital or analogue channels were found. Check all the aerial connections and press  $\oplus$  to start auto-tuning again.

- 3 When the Programme Sorting menu appears on the screen, follow the steps of “Programme Sorting” (page 27).

If you do not change the order in which the analogue channels are stored on the TV, go to step 4.

- 4 Press MENU to exit.

The TV has now tuned in all the available channels.



When a digital broadcast channel cannot be received, or when selecting a region in which there are no digital broadcasts in step 4 (page 7), the time must be set after performing step 4.

## Detaching the Table-Top Stand from the TV



Do not remove the Table-Top Stand for any reason other than to wall-mount the TV.

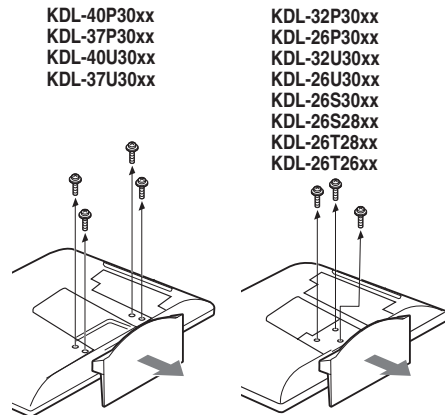

# Safety information

## Installation/Set-up

Install and use the TV set in accordance with the instructions below in order to avoid any risk of fire, electrical shock or damage and/or injuries.

### Installation

- The TV set should be installed near an easily accessible mains socket.
- Place the TV set on a stable, level surface.
- Only qualified service personnel should carry out wall installations.
- For safety reasons, it is strongly recommended that you use Sony accessories, including:
  - **KDL-40P30xx/ KDL-37P30xx/ KDL-32P30xx/ KDL-40U30xx/ KDL-37U30xx/ KDL-32U30xx:** Wall-mount bracket SU-WL500.
  - **KDL-26P30xx/ KDL-26U30xx/ KDL-26S30xx/ KDL-26S28xx/ KDL-26T28xx/ KDL-26T26xx:** Wall-mount bracket SU-WL100.

### Transporting

- Before transporting the TV set, disconnect all cables.
- Two or three people are needed to transport a large TV set.
- When transporting the TV set by hand, hold it as shown on the right. Do not put stress on the LCD panel and the frame around the screen.
- When lifting or moving the TV set, hold it firmly from the bottom.
- When transporting the TV set, do not subject it to jolts or excessive vibration.
- When transporting the TV set for repairs or when moving, pack it using the original carton and packing material.

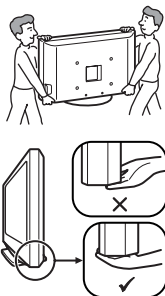

### Installed with stand

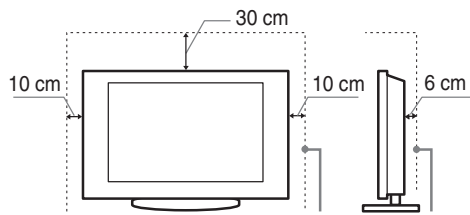

Leave at least this space around the set.

- To ensure proper ventilation and prevent the collection of dirt or dust:
  - Do not lay the TV set flat, install upside down, backwards, or sideways.
  - Do not place the TV set on a shelf, rug, bed or in a closet.
  - Do not cover the TV set with a cloth, such as curtains, or items such as newspapers, etc.
  - Do not install the TV set as shown below.

Air circulation is blocked.

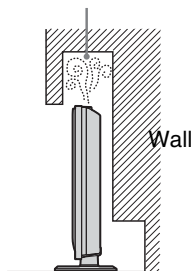

Air circulation is blocked.

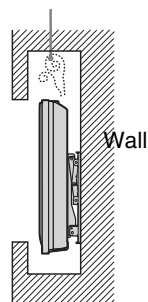

### Ventilation

- Never cover the ventilation holes or insert anything in the cabinet.
- Leave space around the TV set as shown below.
- It is strongly recommended that you use a Sony wall-mount bracket in order to provide adequate air-circulation.

### Installed on the wall

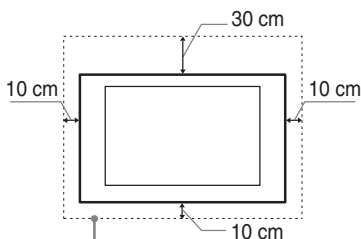

Leave at least this space around the set.

### Mains lead

Handle the mains lead and socket as follows in order to avoid any risk of fire, electrical shock or damage and/or injuries:

- Use only Sony mains leads, not those of other brands.
- Insert the plug fully into the mains socket.
- Operate the TV set on a 220-240 V AC supply only.
- When wiring cables, be sure to unplug the mains lead for your safety and take care not to catch your feet on the cables.
- Disconnect the mains lead from the mains socket before working on or moving the TV set.
- Keep the mains lead away from heat sources.
- Unplug the mains plug and clean it regularly. If the plug is covered with dust and it picks up moisture, its insulation may deteriorate, which could result in a fire.

### Notes

- Do not use the supplied mains lead on any other equipment.
- Do not pinch, bend, or twist the mains lead excessively. The core conductors may be exposed or broken.
- Do not modify the mains lead.
- Do not put anything heavy on the mains lead.
- Do not pull on the mains lead itself when disconnecting the mains lead.



- Do not connect too many appliances to the same mains socket.
- Do not use a poor fitting mains socket.

## Prohibited Usage

Do not install/use the TV set in locations, environments or situations such as those listed below, or the TV set may malfunction and cause a fire, electrical shock, damage and/or injuries.

### Location:

Outdoors (in direct sunlight), at the seashore, on a ship or other vessel, inside a vehicle, in medical institutions, unstable locations, near water, rain, moisture or smoke.

### Environment:

Places that are hot, humid, or excessively dusty; where insects may enter; where it might be exposed to mechanical vibration, near flammable objects (candles, etc). The TV set shall not be exposed to dripping or splashing and no objects filled with liquids, such as vases, shall be placed on the TV.

### Situation:

Do not use when your hands are wet, with the cabinet removed, or with attachments not recommended by the manufacturer. Disconnect the TV set from mains socket and aerial during lightning storms.

## Broken pieces:

- Do not throw anything at the TV set. The screen glass may break by the impact and cause serious injury.
- If the surface of the TV set cracks, do not touch it until you have unplugged the mains lead. Otherwise electric shock may result.

## When not in use

- If you will not be using the TV set for several days, the TV set should be disconnected from the mains for environmental and safety reasons.
- As the TV set is not disconnected from the mains when the TV set is just turned off, pull the plug from the mains to disconnect the TV set completely.
- However, some TV sets may have features that require the TV set to be left in standby to work correctly.

## For children

- Do not allow children to climb on the TV set.
- Keep small accessories out of the reach of children, so that they are not mistakenly swallowed.

## If the following problems occur...

**Turn off** the TV set and unplug the mains lead immediately if any of the following problems occur. Ask your dealer or Sony service centre to have it checked by qualified service personnel.

### When:

- Mains lead is damaged.
- Poor fitting of mains socket.
- TV set is damaged by being dropped, hit or having something thrown at it.
- Any liquid or solid object falls through openings in the cabinet.

# Precautions

## Viewing the TV

- View the TV in moderate light, as viewing the TV in poor light or during long period of time, strains your eyes.
- When using headphones, adjust the volume so as to avoid excessive levels, as hearing damage may result.

## LCD Screen

- Although the LCD screen is made with high-precision technology and 99.99% or more of the pixels are effective, black dots may appear or bright points of light (red, blue, or green) may appear constantly on the LCD screen. This is a structural property of the LCD screen and is not a malfunction.
- Do not push or scratch the front filter, or place objects on top of this TV set. The image may be uneven or the LCD screen may be damaged.
- If this TV set is used in a cold place, a smear may occur in the picture or the picture may become dark. This does not indicate a failure. These phenomena disappear as the temperature rises.
- Ghosting may occur when still pictures are displayed continuously. It may disappear after a few moments.
- The screen and cabinet get warm when this TV set is in use. This is not a malfunction.
- The LCD screen contains a small amount of liquid crystal and mercury. The fluorescent tubes used in this TV set also contain mercury. Follow your local ordinances and regulations for disposal.

## Handling and cleaning the screen surface/cabinet of the TV set

Be sure to unplug the mains lead connected to the TV set from mains socket before cleaning.

To avoid material degradation or screen coating degradation, observe the following precautions.

- To remove dust from the screen surface/cabinet, wipe gently with a soft cloth. If dust is persistent, wipe with a soft cloth slightly moistened with a diluted mild detergent solution.
- Never use any type of abrasive pad, alkaline/acid cleaner, scouring powder, or volatile solvent, such as alcohol, benzene, thinner or insecticide. Using such materials or maintaining prolonged contact with rubber or vinyl materials may result in damage to the screen surface and cabinet material.
- When adjusting the angle of the TV set, move it slowly so as to prevent the TV set from moving or slipping off from its table stand

## Optional Equipment

Keep optional components or any equipment emitting electromagnetic radiation away from the TV set. Otherwise picture distortion and/or noisy sound may occur.

# Overview of the remote

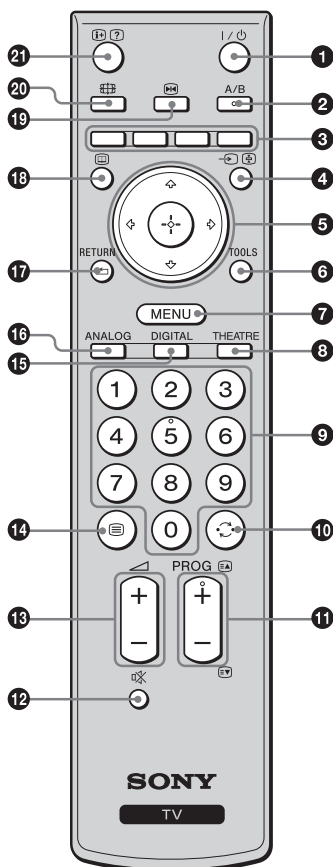

- 1** I/⏻ – TV standby  
Turns the TV on and off from standby mode.
  - 2** A/B – Dual Sound (page 23)
  - 3** Coloured buttons (page 13, 14, 16)
  - 4** ↵/⏻ – Input select / Text hold
    - In TV mode: Selects the input source from equipment connected to the TV sockets (page 18).
    - In Text mode (page 13): Holds the current page.
  - 5** ⬆️/⬆️/⬅️/➡️/⬆️
  - 6** TOOLS (page 13, 19)  
Enables you to access various viewing options and change/make adjustments according to the source and screen format.
  - 7** MENU (page 20)
  - 8** THEATRE  
You can set Theatre Mode on or off. When Theatre Mode is set to on, the optimum audio output (if the TV is connected with an audio system using an HDMI cable) and picture quality for film videos are automatically set.
  - 9** Number buttons
    - In TV mode: Selects channels. For channel numbers 10 and above, enter the second and third digit quickly.
    - In Text mode: Enters the three digit page number to select the page.
  - 10** ⏪ – Previous channel  
Returns to the previous channel watched (for more than five seconds).
  - 11** PROG +/-/⏪/⏩
    - In TV mode: Selects the next (+) or previous (-) channel.
    - In Text mode (page 13): Selects the next (⏪) or previous (⏩) page.
  - 12** 🔇 – Mute the sound
  - 13** 🔊 +/- – Volume
  - 14** ☰ – Text (page 13)
  - 15** DIGITAL – Digital mode (page 12)
  - 16** ANALOG – Analogue mode (page 12)
  - 17** RETURN / ⏪  
Returns to the previous screen of any displayed menu.
  - 18** 📺 – EPG (Digital Electronic Programme Guide) (page 14)
  - 19** 📺 – Picture freeze (page 13)  
Freezes the TV picture.
  - 20** 📺 – Screen mode (page 13)
  - 21** ⓘ/Ⓜ – Info / Text reveal
    - In digital mode: Displays brief details of the programme currently being watched.
    - In analogue mode: Displays information such as current channel number and screen format.
    - In Text mode (page 13): Reveals hidden information (e.g. answers to a quiz).
- 💡
- The number 5, PROG + and A/B buttons have tactile dots. Use the tactile dots as references when operating the TV.
  - If you turn the TV off, Theatre Mode is also turned off.

# Overview of the TV buttons and indicators

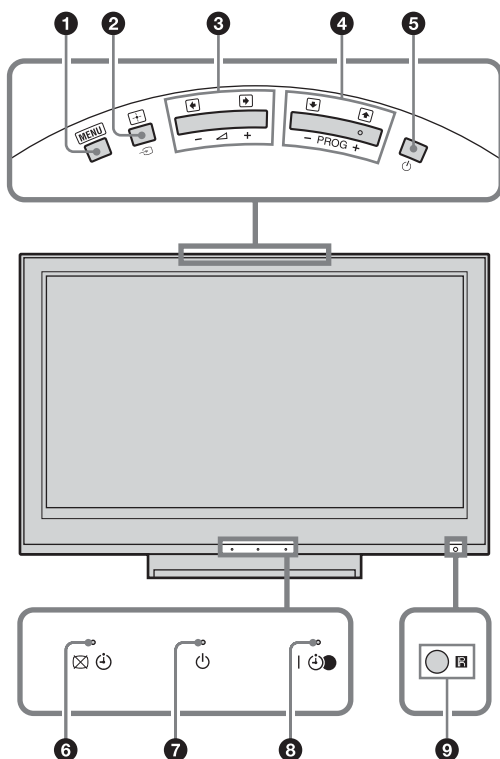

## 1 MENU (page 20)

## 2 – Input select / OK

- In TV mode: Selects the input source from equipment connected to the TV sockets (page 18).
- In TV menu: Selects the menu or option, and confirms the setting.

## 3 +/–/→/←

- In TV mode: Increases (+) or decreases (–) the volume.
- In TV menu: Moves through the options right (→) or left (←).

## 4 PROG +/-/↑/↓

- In TV mode: Selects the next (+) or previous (–) channel.
- In TV menu: Moves through the options up (↑) or down (↓).

## 5 – Power

Turns the TV on or off.



To disconnect the TV completely, pull the plug from the mains.

## 6 – Picture Off / Timer indicator

- Lights up in green when the picture is switched off (page 25).
- Lights up in orange when the timer is set (page 26).

## 7 – Standby indicator

Lights up in red when the TV is in standby mode.

## 8 – Power / Timer REC programme indicator

- Lights up in green when the TV is turned on.
- Lights up in orange when the timer recording is set (page 14).
- Lights up in red during the timer recording.

## 9 Remote control sensor

- Receives IR signals from the remote.
- Do not put anything over the sensor, as its function may be affected.



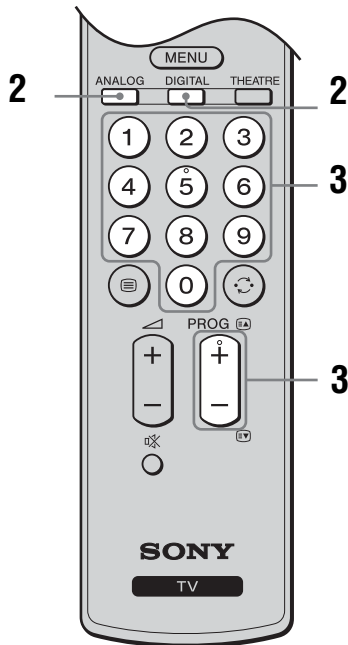
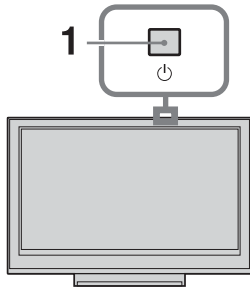

Make sure that the TV is completely turned off before unplugging the mains lead. Unplugging the mains lead while the TV is turned on may cause the indicator to remain lit or may cause the TV to malfunction.

# Watching TV



**1** Press  on the TV (top side) to switch on the TV.

When the TV is in standby mode (the  (standby) indicator on the TV (front) is red), press  on the remote to switch on the TV.

**2** Press DIGITAL to switch to digital mode or ANALOG to switch to analogue mode.

The channels available vary depending on the mode.

**3** Press the number buttons or PROG +/- to select a TV channel.

To select channel numbers 10 and above using the number buttons, enter the second and third digits within two seconds.

To select a digital channel using the Digital Electronic Programme Guide (EPG), see page 14.

### In digital mode

An information banner appears briefly. The following icons may be indicated on the banner.

: Interactive service is available (MHEG Digital Text)

: Interactive service (MHEG Digital Text) is currently disabled

: Radio service

: Scrambled/Subscription service

: Multiple audio languages available

: Subtitles available







: Subtitles available for the hearing impaired

: Recommended minimum age for current programme (from 4 to 18 years)

: Parental Lock

: Current programme is being recorded

### Additional operations

To	Do this
Turn on the TV from Standby mode without sound	Press  . Press  to set the volume level.
Adjust the volume	Press  + (increase)/ - (decrease).
Access the Programme index table (in analogue mode only)	Press  . To select an analogue channel, press  , then press  .

## To access Text

Press . Each time you press , the display changes cyclically as follows:

Text → Text over the TV picture (mix mode) → No Text (exit the Text service)

To select a page, press the number buttons or PROG +/-.

To hold a page, press / .

To reveal hidden information, press / .



When four coloured items appear at the bottom of the Text page, Fastext is available. Fastext allows you to access pages quickly and easily. Press the corresponding coloured button to access the page.

## Picture Freeze

Freezes the TV picture (e.g. to make a note of a telephone number or recipe).

- 1 Press on the remote control.
- 2 Press / / / to adjust the position of the window.
- 3 Press to remove the window.
- 4 Press again to return to normal TV mode.



Not available for AV3, AV4, AV5 and PC input.

## To change the screen format manually to suit the broadcast

Press repeatedly to select the desired screen format.

### Smart\*

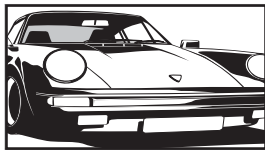

Displays conventional 4:3 broadcasts with an imitation wide screen effect. The 4:3 picture is stretched to fill the screen.

### 4:3

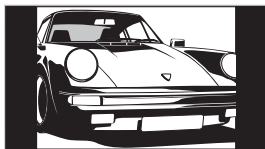

Displays conventional 4:3 broadcasts (e.g. non-wide screen TV) in the correct proportions.

### Wide

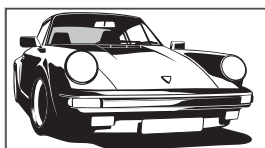

Displays wide screen (16:9) broadcasts in the correct proportions.

### Zoom\*

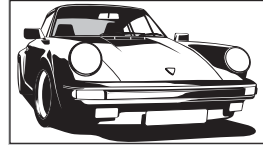

Displays cinemascopic (letter box format) broadcasts in the correct proportions.

### 14:9\*

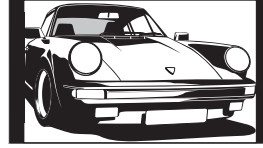

Displays 14:9 broadcasts in the correct proportions. As a result, black border areas are visible on the screen.

\* Parts of the top and bottom of the picture may be cut off.



- HD signal source pictures can only be displayed in “Wide” mode .
- You cannot use this function while the digital banner is displayed.
- Some characters and/or letters at the top and the bottom of the picture may not be visible in Smart mode. In such a case, you can select “V-Size” using the “Screen” menu and adjust vertical size to make it visible.



- When “Auto Format” is set to “On”, the TV will automatically select the best mode to suit the broadcast (page 25).
- You can adjust the position of the picture when selecting “Smart” (50Hz), “14:9” or “Zoom”. Press / to move up or down (e.g. to read subtitles).

## Using the Tools menu

Press TOOLS to display the following options when viewing a TV programme.

Options	Description
Close	Closes the Tools menu.
Picture Mode	See page 21.
Sound Effect	See page 23.
Speaker	See page 24.
Audio Language (in digital mode only)	See page 31.
Subtitle Setting (in digital mode only)	See page 31.
Sleep Timer	See page 26.
Power Saving	See page 25.
System Information (in digital mode only)	Displays the system information screen.



































# Checking the Digital Electronic Programme Guide (EPG) DV3\*



- 1 In digital mode, press .
- 2 Perform the desired operation as shown in the following table or displayed on the screen.

## Digital Electronic Programme Guide (EPG)

\* This function may not be available in some countries/regions.

To	Do this
Watch a programme	Press  /  /  /  to select the programme, then press  .
Turn off the EPG	Press  .
Sort the programme information by category – Category list	<ol style="list-style-type: none"> <li>1 Press the blue button.</li> <li>2 Press /// to select a category, then press .</li> </ol> <p>The categories available include:  <b>“All Categories”</b>: Contains all available channels.  <b>Category name (e.g. “News”)</b>: Contains all channels corresponding to the selected category.</p>
Set a programme to be recorded – Timer REC	<ol style="list-style-type: none"> <li>1 Press /// to select the future programme you want to record, then press .</li> <li>2 Press / to select “Timer REC”.</li> <li>3 Press  to set the TV and your VCR timers.</li> </ol> <p>A red  symbol appears by that programme’s information. The  indicator on the TV front panel lights up in orange.</p> <p> To record the programme you are currently watching, press .</p>
Set a programme to be displayed automatically on the screen when it starts – Reminder	<ol style="list-style-type: none"> <li>1 Press /// to select the future programme you want to display, then press .</li> <li>2 Press / to select “Reminder”, then press .</li> </ol> <p>A  symbol appears by that programme’s information. The  indicator on the TV front panel lights up in orange.</p> <p> If you switch the TV to standby mode, it will automatically turn itself on when the programme is about to start.</p>

To	Do this
Set the time and date of a programme you want to record – Manual timer REC	<ol style="list-style-type: none"> <li>1 Press <math>\uparrow/\downarrow/\leftarrow/\rightarrow</math> to select the future programme you want to record, then press <math>\text{Ⓜ}/\text{Ⓢ}</math>.</li> <li>2 Press <math>\uparrow/\downarrow</math> to select “Manual timer REC”, then press <math>\text{⊕}</math>.</li> <li>3 Press <math>\uparrow/\downarrow</math> to select the date, then press <math>\rightarrow</math>.</li> <li>4 Set the start and stop time in the same way as in step 3.</li> <li>5 Press <math>\uparrow/\downarrow</math> to select the programme, then press <math>\text{⊕}</math>.</li> <li>6 Press <math>\text{⊕}</math> to set the TV and your VCR timers. A red <math>\text{⊕}</math> symbol appears by that programme’s information. The <math>\text{⊕}</math> indicator on the TV front panel lights up in orange.</li> </ol> <p> To record the programme you are currently watching, press <math>\text{Ⓜ}/\text{Ⓢ}</math>.</p>
Cancel a recording/reminder – Timer list	<ol style="list-style-type: none"> <li>1 Press <math>\text{Ⓜ}/\text{Ⓢ}</math>.</li> <li>2 Press <math>\uparrow/\downarrow</math> to select “Timer list”, then press <math>\text{⊕}</math>.</li> <li>3 Press <math>\uparrow/\downarrow</math> to select the programme you want to cancel, then press <math>\text{⊕}</math>.</li> <li>4 Press <math>\uparrow/\downarrow</math> to select “Cancel Timer”, then press <math>\text{⊕}</math>. A display appears to confirm that you want to cancel the programme.</li> <li>5 Press <math>\leftarrow/\rightarrow</math> to select “Yes”, then press <math>\text{⊕}</math> to confirm.</li> </ol>



- You can set VCR timer recording on the TV only for SmartLink compatible VCRs. If your VCR is not SmartLink compatible, a message will be displayed to remind you to set your VCR timer.
- Once a recording has begun, you can switch the TV to standby mode, but do not turn off the TV completely or the recording may be cancelled.
- If an age restriction for programmes has been selected, a message asking for a PIN code will appear on the screen. For details, see “Parental Lock” on page 31.

# Using the Digital Favourite list DV3\*

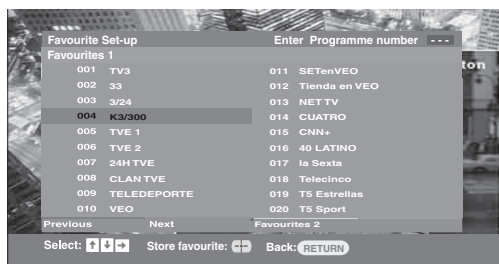

Digital Favourite list

\* This function may not be available in some countries/regions.

The Favourite feature allows you to specify up to four lists of your favourite programmes.

- 1** Press MENU.
- 2** Press  $\uparrow/\downarrow$  to select “Digital Favourites”, then press  $\oplus$ .
- 3** Perform the desired operation as shown in the following table or displayed on the screen.

To	Do this
Create your Favourite list for the first time	<ol style="list-style-type: none"> <li><b>1</b> Press <math>\oplus</math> to select “Yes”.</li> <li><b>2</b> Press yellow key to select favourite list.</li> <li><b>3</b> Press <math>\uparrow/\downarrow</math> to select the channel you want to add, then press <math>\oplus</math>. Channels that are stored in the Favourite list are indicated by a ♥ symbol.</li> </ol>
Watch a channel	<ol style="list-style-type: none"> <li><b>1</b> Press yellow key to navigate through favourite lists.</li> <li><b>2</b> Press <math>\uparrow/\downarrow</math> to select the channel, then press <math>\oplus</math>.</li> </ol>
Turn off the Favourite list	Press RETURN.
Add or remove channels in the currently edited Favourite list	<ol style="list-style-type: none"> <li><b>1</b> Press the blue button.</li> <li><b>2</b> Press the yellow button to choose the list you want to edit.</li> <li><b>3</b> Press <math>\uparrow/\downarrow</math> to select the channel you want to add or remove, then press <math>\oplus</math>.</li> </ol>
Remove all channels from the current Favourite list	<ol style="list-style-type: none"> <li><b>1</b> Press the blue button.</li> <li><b>2</b> Press the yellow button to select the favourite list you want to edit.</li> <li><b>3</b> Press the blue button.</li> <li><b>4</b> Press <math>\leftarrow/\rightarrow</math> to select “Yes”, then press <math>\oplus</math> to confirm.</li> </ol>



# Connecting optional equipment

You can connect a wide range of optional equipment to your TV. Connecting cables are not supplied.

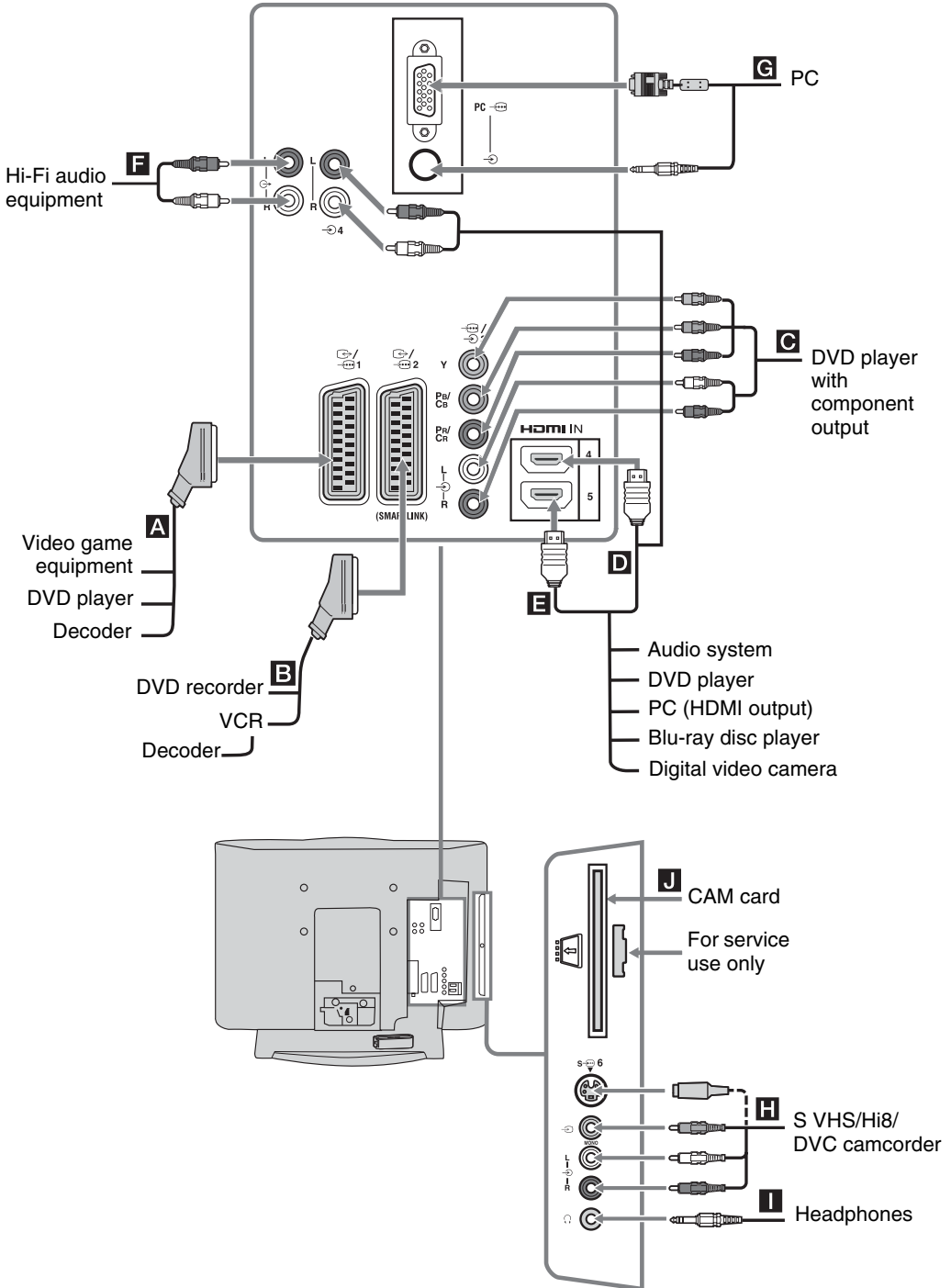

# Viewing pictures from connected equipment

Switch on the connected equipment, then perform one of the following operation.

## For equipment connected to the scart sockets using a fully-wired 21-pin scart lead

Start playback on the connected equipment. The picture from the connected equipment appears on the screen.

## For an auto-tuned VCR (page 7)

In analogue mode, press PROG +/-, or the number buttons, to select the video channel.

## For other connected equipment

Press / to display the connected equipment list. Press / to select the desired input source, then press . (The highlighted item is selected if 2 seconds pass without any operation after pressing /.) When the input source is set to "Skip" in the "AV Preset" menu under the "Set-up" menu (page 27), that input does not appear in the list.

Symbol on the screen	Description
AV1/ AV2	To see the equipment connected to <b>A</b> .
AV2/ AV3	To see the equipment connected to <b>B</b> . SmartLink is a direct link between the TV and a VCR/DVD recorder.
AV3	To see the equipment connected to <b>C</b> .
AV4	HDMI IN 4*. To see the equipment connected to <b>D</b> . If the equipment has a DVI socket, connect the DVI socket to the HDMI IN socket through a DVI-HDMI adaptor interface (not supplied), and connect the equipment's audio out sockets to the audio in HDMI IN sockets.
AV5	HDMI IN 5*. To see the equipment connected to <b>E</b> .

- \*
- Be sure to use only an HDMI cable that bears the HDMI logo.
  - When HDMI control compatible equipment is connected, communication with the connected equipment is supported. Refer to page 19 to set up this communication.

Symbol on the screen	Description
S AV6 or  AV6	To see the equipment connected to <b>H</b> . To avoid picture noise, do not connect the camcorder to the video socket  6 and the S video socket S6 at the same time. If you connect mono equipment, connect to the L socket 6.
PC	To see the equipment connected to <b>G</b> . It is recommended to use a PC cable with ferrites.

To connect	Do this
Headphones <b>I</b>	Connect to the  socket to listen to sound from the TV on headphones.
Conditional Access Module (CAM) <b>J</b>	To use Pay Per View services. For details, refer to the instruction manual supplied with your CAM. To use the CAM, remove the rubber cover from the CAM slot. Switch off the TV when inserting your CAM into the CAM slot. When you do not use the CAM, we recommend that you replace the cover on the CAM slot. CAM is not supported in all countries. Please check with your authorized dealer.

Hi-Fi audio equipment <b>F</b>	Connect to the audio output sockets  to listen to the sound from the TV on Hi-Fi audio equipment.
--------------------------------	---

## Additional operations

To	Do this
Return to normal TV mode	Press DIGITAL or ANALOG.
Access the Digital Favourites (in digital mode only)	Press . For details, see page 16.
Change the volume of the connected HDMI control compatible audio system	Press  +/-.
Mute the sound of the connected HDMI control compatible audio system	Press . Press again to restore.

## Using the Tools menu

Press TOOLS to display the following options when viewing pictures from connected equipment.

Options	Description
Close	Closes the Tools menu.
Picture Mode (except PC input mode)	See page 21.
Display Mode (in PC input mode only)	See page 21.
Sound Effect	See page 23.
Speaker	See page 24.
PIP (in PC input mode only)	See page 19.
H Centre (in PC input mode only)	See page 26.
V Lines (in PC input mode only)	See page 26.
Sleep Timer (except PC input mode)	See page 26.
Power Saving	See page 25.

## To view two pictures simultaneously – PIP (Picture in Picture)

You can view two pictures (PC input and TV programme) on the screen simultaneously. Connect a PC (page 17), and make sure that images from a PC appear on the screen.



You cannot display resolutions higher than WXGA (1280 × 768 pixels).

- 1 Press TOOLS to display the Tools menu.
- 2 Press  $\uparrow/\downarrow$  to select “PIP”, then press  $\oplus$ .

The picture from the connected PC is displayed with full size and the TV programme is displayed on the right corner.

You can use  $\uparrow/\downarrow/\leftarrow/\rightarrow$  to move the TV programme screen position.

- 3 Press number buttons or PROG +/- to select the TV channel.

### To return to single picture mode

Press RETURN.



You can switch the audible picture by selecting “PC Sound/TV Sound” from the Tools menu.

## Using HDMI control

The HDMI control function allows equipment to control each other using HDMI CEC (Consumer Electronics Control) specified by HDMI.

You can perform interlocked control operations between Sony HDMI control compatible equipment such as a TV, DVD recorder with hard disk and audio system by connecting the equipment with HDMI cables.

Be sure to correctly connect and set the compatible equipment to use the HDMI control function.

### To connect the HDMI control compatible equipment

Connect the compatible equipment and the TV with an HDMI cable. When connecting an audio system, in addition to the HDMI cable, be sure to also connect the audio output socket  $\odot$  of the TV and the audio system. For details, see page 17.

### To make the HDMI control settings

HDMI control must be set on both the TV side and the connected equipment side. See HDMI Set-up (page 28) for the TV side settings. See the operating instructions of the connected equipment for setting details.

### HDMI control functions

- Turns the connected equipment off interlocked with the TV.
- Turns the TV on interlocked with the connected equipment and automatically switches the input to the equipment when the equipment starts to play.
- If you turn on a connected audio system while the TV is on, the input switches to the audio from the audio system.
- Adjusts the volume and mutes the sound of a connected audio system.

## Using MENU Functions

# Navigating through menus

“MENU” allows you to enjoy various convenient features of this TV. You can easily select channels or inputs sources and change the settings for your TV.

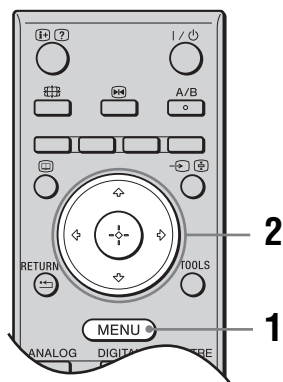

- 1 Press MENU.
- 2 Press  $\uparrow/\downarrow$  to select an option, then press  $\oplus$ .  
To exit the menu, press MENU.

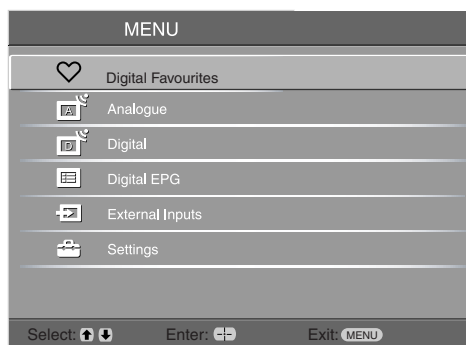

- 1 **Digital Favourites\***  
Displays the Favourite list. For details about settings, see page 16.
- 2 **Analogue**  
Returns to the last viewed analogue channel.
- 3 **Digital\***  
Returns to the last viewed digital channel.
- 4 **Digital EPG\***  
Displays the Digital Electronic Programme Guide (EPG).  
For details about settings, see page 14.

## 5 External Inputs

Selects equipment connected to your TV.

- To watch the desired external input, select the input source, then press  $\oplus$ .

## 6 Settings

Displays the Settings menu where most of the advanced settings and adjustments are performed.

1 Press  $\uparrow/\downarrow$  to select a menu icon, then press  $\oplus$ .

2 Press  $\uparrow/\downarrow/\leftarrow/\rightarrow$  to select an option or adjust a setting, then press  $\oplus$ .

For details about settings, see page 21 to 31.



The options you can adjust vary depending on the situation. Unavailable options are greyed out or not displayed.

\* This function may not be available in some countries/regions.

# Picture Adjustment menu

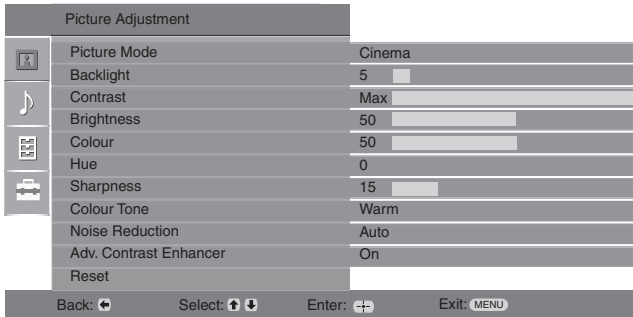

You can select the options listed below on the Picture menu. To select options in “Settings”, see “Navigating through menus” (page 20).

## Picture Mode

Selects the picture mode except for PC input source.  
**“Vivid”**: For enhanced picture contrast and sharpness.  
**“Standard”**: For standard picture. Recommended for home entertainment.  
**“Cinema”**: For viewing film-based content. Most suitable for viewing in a theatre-like environment. This picture setting was developed in collaboration with Sony Pictures Entertainment to faithfully reproduce movies as intended by their creators.  
 Selects the display mode for PC input source.  
**“Video”**: For video images.  
**“Text”**: For text, charts or tables.

## Display Mode (only in PC mode)

## Backlight

Adjusts the brightness of the backlight.

## Contrast

Increases or decreases picture contrast.

## Brightness

Brightens or darkens the picture.

## Colour

Increases or decreases colour intensity.

## Hue

Increases or decreases the green tones.



“Hue” can only be adjusted for an NTSC colour signal (e.g., U.S.A. video tapes).

## Sharpness

Sharpens or softens the picture.

## Colour Tone

Adjusts the whiteness of the picture.

**“Cool”**: Gives the white colours a blue tint.

**“Neutral”**: Gives the white colours a neutral tint.

**“Warm”**: Gives the white colours a red tint.





“Warm” can not be selected when you set “Picture Mode” to “Vivid”.

---

## Noise Reduction

Reduces the picture noise (snowy picture) in a weak broadcast signal.  
“**Auto**”: Automatically reduces the picture noise (in analogue mode only).  
“**High/Mid/Low**”: Modifies the effect of the noise reduction.  
“**Off**”: Turns off the “Noise Reduction” feature.



“Auto” is not available for  AV3,  AV4,  AV5 and PC mode.

---

## Adv. Contrast Enhancer

Automatically adjusts “Backlight” and “Contrast” to the most suitable settings judging from the brightness of the screen. This setting is especially effective for dark images scenes. It will increase the contrast distinction of the darker picture scenes.

---

## Reset

Resets all picture settings except “Picture Mode” and “Display Mode” (only in PC mode) to the factory settings.



“Brightness”, “Colour”, “Sharpness” and “Adv. Contrast Enhancer” are not available when “Picture Mode” is set to “Vivid” or when “Display Mode” is set to “text”.

# Sound Adjustment menu

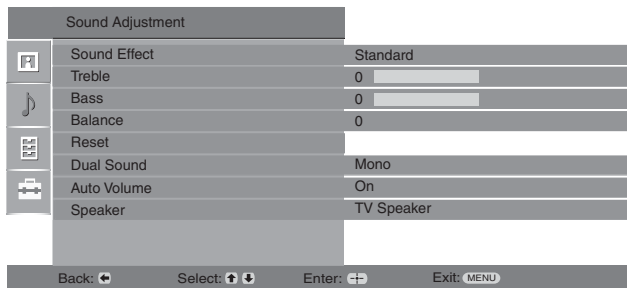

You can select the options listed below on the Sound menu. To select options in “Settings”, see “Navigating through menus” (page 20).

## Sound Effect

Selects the sound mode.

**“Standard”**: Enhances clarity, detail, and sound presence by using “BBE High definition Sound System.”

**“Dynamic”**: Intensifies clarity and sound presence for better intelligibility and musical realism by using the “BBE High definition Sound System.”

**“BBE ViVA”**: BBE ViVA Sound provides musically accurate natural 3D image with Hi-Fi sound. The clarity of the sound is improved by BBE while the width depth and height of sound image are expanded by BBE’s proprietary 3D sound process. BBE ViVA Sound is compatible with all TV programs including news, music, dramas, movies, sports and electronic games.

**“Dolby Virtual”**: Uses the TV speakers to simulate the surround effect produced by a multi channel system.

**“Off”**: Flat response. Also allows you to store your preferred settings.



- If you set “Auto Volume” to “On”, “Dolby Virtual” changes to “Standard”.
- If headphones are connected, “Sound Effect” changes to “Off”.

## Treble

Adjusts higher-pitched sounds.

## Bass

Adjusts lower-pitched sounds.

## Balance

Emphasizes left or right speaker balance.

## Reset

Resets all the sound settings to the factory settings.

## Dual Sound

Selects the sound from the speaker for a stereo or bilingual broadcast.

**“Stereo”**, **“Mono”**: For a stereo broadcast.

**“A”/“B”/“Mono”**: For a bilingual broadcast, select “A” for sound channel 1, “B” for sound channel 2, or “Mono” for a mono channel, if available.



If you select other equipment connected to the TV, set “Dual Sound” to “Stereo”, “A” or “B”.

## Auto Volume

Keeps a constant volume level even when volume level gaps occur (e.g., adverts tend to be louder than programmes).

---

## Speaker

Turns on/off the TV's internal speakers.

**“TV Speaker”:** The TV speakers are turned on in order to listen to the TV's sound through the TV speakers.

**“Audio System”:** The TV speakers are turned off in order to listen to the TV's sound only through your external audio equipment connected to the audio output sockets. When connected with an HDMI control compatible equipment, you can turn the connected equipment on interlocked with the TV. This setting must be made after connecting the equipment.

---



“Sound Effect”, “Treble”, “Bass”, “Balance” and “Auto Volume” are not available when “Speaker” is set to “Audio System”.



# Features menu

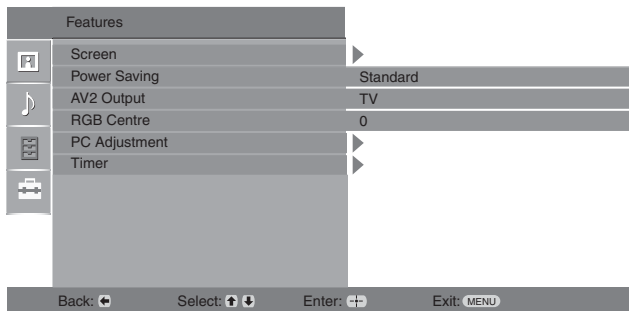

You can select the options listed below on the Features menu. To select options in “Settings”, see “Navigating through menus” (page 20).

## Screen

Changes the screen format.

“**Auto Format**”: Automatically changes the screen format according to the broadcast signal.

“**Screen Format**”: For details about the screen format, see page 13

“**V-Size**”: Adjust the vertical size of the picture when “Screen Format” is set to “Smart”.



- Even if you have selected “On” or “Off” in “Auto Format”, you can always modify the format of the screen by pressing  repeatedly.
- “Auto Format” is available for PAL and SECAM signals only.

## Power Saving





Selects the power saving mode to reduce the power consumption of the TV.

“**Standard**”: Default settings.



“**Reduce**”: Reduces the power consumption of the TV.

“**Picture Off**”: Switches off the picture. You can listen to the sound with the picture off.

## AV2 Output

Sets a signal to be output through the socket labelled  /  2 on the rear of the TV. If you connect a VCR to the  /  2 socket, you can then record from the equipment connected to other sockets of the TV.





“**TV**”: Outputs a broadcast.

“**Auto**”: Outputs whatever is being viewed on the screen. Not available for  AV3,  AV4,  AV5 and PC.

## RGB Centre

Adjusts the horizontal picture position so that the picture is in the middle of the screen.



This option is only available if an RGB source has been connected to the Scarts connectors  1 /  1 or  2 /  2 on the rear of the TV.

---

## PC Adjustment

Customizes the TV screen as a PC monitor.



This option is only available if you are in PC Mode.

“**Phase**” : Adjust the screen when a part of a displayed text or image is not clear.

“**Pitch**” : Enlarges or shrinks the screen size horizontally.

“**H Centre**” : Moves the screen to the left or to the right.

“**V Lines**” : Corrects the picture lines while viewing an RGB input signal from the PC  connector.

“**Power saving**” : Turns to standby mode if no PC signal is received.

“**Reset**” : Resets to the factory settings.

---

## Timer

Sets the timer to turn on/off the TV.

### Sleep Timer

Sets a period of time after which the TV automatically switches itself into standby mode.

When the Sleep Timer is activated, the  (Timer) indicator on the TV (front) lights up in orange.



- If you switch off the TV and switch it on again, “Sleep Timer” is reset to “Off”.
- “Sleep timer will end soon. Power will be turned off” appears on the screen one minute before the TV switches to standby mode.

### Clock Set

Allows you to adjust the clock manually. When the TV is receiving digital channels, the clock cannot be adjusted manually since it is set to the time code of the broadcasted signal.

### Timer

Sets the timer to turn on/off the TV.

“**Timer Mode**” : Selects the desired period.

“**On Time**” : Sets the time to turn on the TV.

“**Off Time**” : Sets the time to turn off the TV.

# Set-up menu

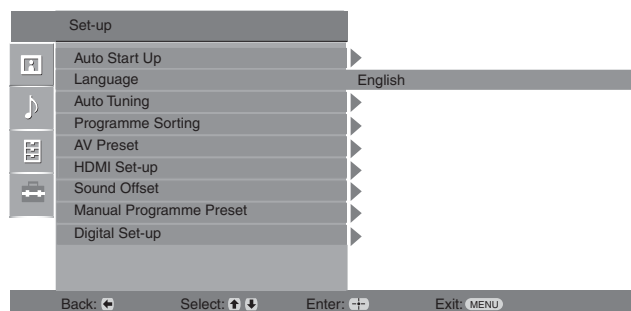

You can select the options listed below on the Set-up menu. To select options in “Settings”, see “Navigating through menus” (page 20).

## Auto Start Up

Starts the “first time operation menu” to select the language, country/region and location, and tune in all available digital and analogue channels. Usually, you do not need to do this operation because the language and country/region will have been selected and channels already tuned when the TV was first installed (page 7). However, this option allows you to repeat the process (e.g., to retune the TV after moving house, or to search for new channels that have been launched by broadcasters).

## Language

Selects the language in which the menus are displayed.

## Auto Tuning

Tunes in all the available analogue channels. Usually you do not need to do this operation because the channels are already tuned when the TV was first installed (page 7). However, this option allows you to repeat the process (e.g., to retune the TV after moving house, or to search for new channels that have been launched by broadcasters).

## Programme Sorting

Changes the order in which the analogue channels are stored on the TV.

- 1 Press  $\uparrow/\downarrow$  to select the channel you want to move to a new position, then press  $\rightarrow$ .
- 2 Press  $\uparrow/\downarrow$  to select the new position for your channel, then press  $\oplus$ .

## AV Preset

Assigns a name to any equipment connected to the side and rear sockets. The name will be displayed briefly on the screen when the equipment is selected. You can skip an input source that is not connected to any equipment.

- 1 Press  $\uparrow/\downarrow$  to select the desired input source, then press  $\oplus$ .
- 2 Press  $\uparrow/\downarrow$  to select the desired option below, then press  $\oplus$ .
  - AV1 (or AV2/ AV3/ AV4/AV5/AV6/ PC), VIDEO, DVD, CABLE, GAME, CAM, SAT: Uses one of the preset labels to assign a name to connected equipment.
  - “Edit”: Creates your own label.

1 Press  $\uparrow/\downarrow$  to select the desired letter or number (“\_” for a blank space), then press  $\rightarrow$ .

### If you input a wrong character

Press  $\leftarrow/\rightarrow$  to select the wrong character. Then, press  $\uparrow/\downarrow$  to select the correct character.

2 Repeat the procedure in step 1 until the name is completed.

3 Select “OK”, then press  $\oplus$ .

- “Skip”: Skips an input source that is not connected to any equipment when you press  $\uparrow/\downarrow$  to select the input source.

Continued

---

## HDMI Set-up

This is used to set the HDMI control compatible equipment connected to the HDMI sockets. Note that the interlock setting must also be made on the connected HDMI control compatible equipment side.

**“HDMI Control”**: This sets whether to interlock the HDMI control compatible equipment and the TV. When set to “On”, the following menu items can be performed.

**“Auto Devices Off”**: When this is set to “On”, the HDMI control compatible equipment turn on and off interlocked with the TV.

**“Auto TV On”**: When this is set to “On”, the TV turns on interlocked with the HDMI control compatible equipment.

**“Device List Update”**: Creates or updates the “HDMI Device List”. Up to 11 HDMI control compatible equipment can be connected, and up to 5 equipment can be connected to a single socket. Be sure to update the “HDMI Device List” when you change the HDMI control compatible equipment connections or settings.

**“HDMI Device List”**: Displays the connected HDMI control compatible equipments.

---

## Sound Offset

Sets an independent volume level to each equipment connected to the TV.

---

## Manual Programme Preset

Before selecting “Label”/“AFT”/“Audio Filter”/“Skip”/“Decoder”, press  $\uparrow/\downarrow$  to select the programme number you want to modify. Then, press  $\oplus$ .

### System

Presets programme channels manually.

- 1 Press  $\uparrow/\downarrow$  to select “System”, then press  $\oplus$ .
- 2 Press  $\uparrow/\downarrow$  to select one of the following TV broadcast systems, then press  $\leftarrow$ .

B/G: For western European countries/regions

D/K: For eastern European countries/regions

L: For France

I: For the United Kingdom



Depending on the country/region selected for “Country” (page 6), this option may not be available.

### Channel

- 1 Press  $\uparrow/\downarrow$  to select “Channel”, then press  $\oplus$ .
- 2 Press  $\uparrow/\downarrow$  to select “S” (for cable channels) or “C” (for terrestrial channels), then press  $\Rightarrow$ .
- 3 Tune the channels as follows:

#### If you do not know the channel number (frequency)

Press  $\uparrow/\downarrow$  to search for the next available channel. When a channel has been found, the search will stop. To continue searching, press  $\uparrow/\downarrow$ .

#### If you know the channel number (frequency)

Press the number buttons to enter the channel number of the broadcast you want or your VCR channel number.

- 4 Press  $\oplus$  to jump to “Confirm”, then press  $\oplus$ .

Repeat the procedure above to preset other channels manually.

### Label

Assigns a name of your choice, up to five letters or numbers, to the selected channel.

### AFT

Allows you to fine-tune the selected programme number manually if you feel that a slight tuning adjustment will improve the picture quality.

---

---

### Audio Filter

Improves the sound for individual channels in the case of distortion in mono broadcasts. Sometimes a non-standard broadcast signal can cause sound distortion or intermittent sound muting when watching mono programmes.

If you do not experience any sound distortion, we recommend that you leave this option set to the factory setting “Off”.





You cannot receive stereo or dual sound when “Low” or “High” is selected.

“Audio Filter” is not available when “System” is set to “L”.

### Skip

Skips unused analogue channels when you press PROG +/- to select channels. (You can still select a skipped channel using the number buttons.)

### Decoder

Views and records the scrambled channel selected when using a decoder connected directly to scart connector  1, or to scart connector  2 via a VCR.



Depending on the country/region selected for “Country” (page 6), this option may not be available.

### Confirm

Saves changes made to the “Manual Programme Preset” settings.

---

# Digital Set-up menu DV3

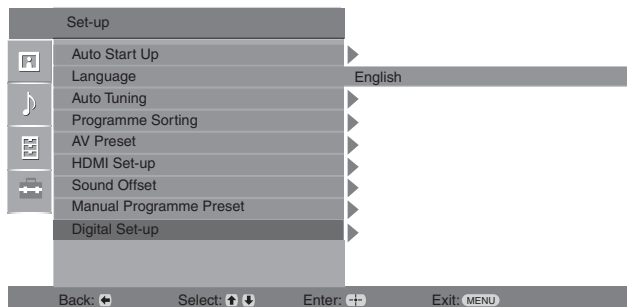

You can select the options listed below on the “Digital Set-up” menu. To select options in “Settings”, refer to “Navigating through menus” (page 20).



Some functions may not be available in some countries/regions.

## Digital Tuning

### Digital Auto Tuning

Tunes in the available digital channels.

This option allows you to retune the TV after moving house, or to search for new channels that have been launched by broadcasters). For details, see “Auto-tuning the TV” on page 7.

### Programme List Edit

Removes any unwanted digital channels stored on the TV, and changes the order of the digital channels stored on the TV.

- 1 Press  $\uparrow/\downarrow$  to select the channel you want to remove or move to a new position.

Press the number buttons to enter the known three-digit programme number of the broadcast you want.

- 2 Remove or change the order of the digital channels as follows:

#### To remove the digital channel

Press  $\oplus$ . After a confirmation message appears, press  $\leftarrow$  to select “Yes”, then press  $\oplus$ .

#### To change the order of the digital channels

Press  $\rightleftarrows$ , then press  $\uparrow/\downarrow$  to select the new position for the channel and press  $\leftarrow$ .

- 3 Press RETURN.

### Digital Manual Tuning

Tunes the digital channels manually.

- 1 Press the number button to select the channel number you want to manually tune, then press  $\uparrow/\downarrow$  to tune the channel.
- 2 When the available channels are found, press  $\uparrow/\downarrow$  to select the channel you want to store, then press  $\oplus$ .
- 3 Press  $\uparrow/\downarrow$  to select the programme number where you want to store the new channel, then press  $\oplus$ .

Repeat the above procedure to manually tune other channels.

### Subtitle Set-up

“**Subtitle Setting**”: When “For Hard Of Hearing” is selected, some visual aids may also be displayed with the subtitles (if TV channels broadcast such information).

“**Subtitle Language**”: Selects which language subtitles are displayed in.

### Audio Set-up

“**Audio Type**”: Switches to broadcast for the hearing impaired when “For Hard Of Hearing” is selected.

“**Audio Language**”: Selects the language used for a programme. Some digital channels may broadcast several audio languages for a programme.

“**Audio Description**”: Provides audio description (narration) of visual information if TV channels broadcast such information.

“**Mixing Level**”: Adjusts the TV main audio and Audio Description output levels.



This option is only available when “Audio Description” is set to “On”.

### Banner Mode

“**Basic**”: Displays programme information with a digital banner.

“**Full**”: Displays programme information with a digital banner, and displays detailed programme information below that banner.

### Radio Display

The screen wallpaper is displayed when listening to a radio broadcast after 20 seconds without pressing any button.

You can select the screen wallpaper colour, or display a random colour.

To cancel the screen wallpaper display temporarily, press any button.

### Parental Lock

Sets an age restriction for programmes. Any programme that exceeds the age restriction can only be watched after a PIN Code is entered correctly.

**1** Press the number buttons to enter your existing PIN code.

If you have not previously set a PIN, a PIN code entry screen appears. Follow the instructions of “PIN Code” below.

**2** Press  $\uparrow/\downarrow$  to select the age restriction or “None” (for unrestricted watching), then press  $\oplus$ .

**3** Press RETURN.

### PIN Code

#### To set your PIN for the first time

**1** Press the number buttons to enter the new PIN code.

**2** Press RETURN.

#### To change your PIN

**1** Press the number buttons to enter your existing PIN code.

**2** Press the number buttons to enter the new PIN code.

**3** Press RETURN.



PIN code 9999 is always accepted.

### Technical Set-up

“**Auto Service Update**”: Enables the TV to detect and store new digital services as they become available.

“**Software Download**”: Enables the TV to automatically receive software updates, free through your existing aerial (when issued). Sony recommends that this option is set to “On” at all times. If you do not want your software to be updated, set this option to “Off”.

“**System Information**”: Displays the current software version and the signal level.

“**Time Zone**”: Allows you to manually select the time zone you are in, if it is not the same as the default time zone setting for your country/region.

“**Auto DST**”: Sets whether or not to automatically switch between summer time and winter time.

- “On”: Automatically switches between summer time and winter time according to the calendar.
- “Off”: The time is displayed according to the time difference set by “Time Zone”.

### CA Module Set-up

Allows you to access a pay TV service once you obtain a Conditional Access Module (CAM) and a view card. See page 17 for the location of the  (PCMCIA) socket.

# Specifications

### Display Unit

Power Requirements:

220–240 V AC, 50 Hz

Screen Size:

KDL-40xxxxx: 40 inches

KDL-37xxxxx: 37 inches

KDL-32xxxxx: 32 inches

KDL-26xxxxx: 26 inches

Display Resolution:

1,366 dots (horizontal) × 768 lines (vertical)

Power Consumption:

KDL-40xxxxx: 165 W or less

KDL-37xxxxx: 150 W or less

KDL-32xxxxx: 130 W or less

KDL-26xxxxx: 90 W or less

Standby Power Consumption\*:

KDL-40xxxxx: 0,6 W or less

KDL-37xxxxx: 0,6 W or less

KDL-32xxxxx: 0,7 W or less

KDL-26xxxxx: 0,7 W or less

\* Specified standby power is reached after the TV finishes necessary internal processes.

Dimensions (w × h × d):

KDL-40xxxxx:

Approx: 982 x 690 x 265 mm (with stand)

Approx: 982 x 643 x 124 mm (without stand)

KDL-37xxxxx:

Approx: 906 x 658 x 265 mm (with stand)

Approx: 906 x 611 x 126 mm (without stand)

KDL-32xxxxx:

Approx: 790 x 577 x 214 mm (with stand)

Approx: 790 x 530 x 119 mm (without stand)

KDL-26xxxxx:

Approx: 657 x 500 x 214 mm (with stand)

Approx: 657 x 453 x 121 mm (without stand)

Mass:

KDL-40P30xx/ KDL-40U30xx:

Approx: 23,5 kg (with stand)

Approx: 20,0 kg (without stand)

KDL-37P30xx/ KDL-37U30xx:

Approx: 21,0 kg (with stand)

Approx: 18,0 kg (without stand)

KDL-32P30xx/ KDL-32U30xx:

Approx: 15,0 kg (with stand)

Approx: 13,0 kg (without stand)

KDL-26P30xx/ KDL-26U30xx:

Approx: 12,0 kg (with stand)

Approx: 10,0 kg (without stand)

KDL-26Sxxxx/KDL-26Txxxx:

Approx: 12,5 kg (with stand)

Approx: 10,5 kg (without stand)

### Panel System

LCD (Liquid Crystal Display) Panel

### TV System

Depending on your country/region selection

Analogue: B/G/H, D/K, L, I

Digital: DVB-T

### Colour/Video System

Analogue: PAL, SECAM

NTSC 3.58, 4.43 (only Video In)

Digital: MPEG-2 MP@ML

### Aerial

75 ohm external terminal for VHF/UHF

### Channel Coverage

Analogue: 48.25 - 855.25 MHz

Digital: VHF Band III (177.5 - 226.5 MHz)

UHF E21 - E69 (474 - 858 MHz)

### Terminals

 1

21-pin Scart connector (CENELEC standard) including audio/video input, RGB input, and TV audio/video output.

 2 (SMARTLINK)

21-pin Scart connector (CENELEC standard) including audio/video input, RGB input, selectable audio/video output, and SMARTLINK interface.

 3

Supported formats: 1080i, 720p, 576p, 576i, 480p, 480i

Y: 1 Vp-p, 75 ohms, 0.3V negative sync

P<sub>B</sub>/C<sub>B</sub>: 0.7 Vp-p, 75 ohms

P<sub>R</sub>/C<sub>R</sub>: 0.7 Vp-p, 75 ohms

 3

Audio input (phono jacks)

500 mVrms

Impedance: 47 kilo ohms

HDMI IN 4, 5

Video: 1080i, 720p, 576p, 576i, 480p, 480i

Audio: Two channel linear PCM

32, 44.1 and 48 kHz, 16, 20 and 24 bits

PC (see table)

Analogue audio (phono jacks):

500 mVrms, Impedance 47 kilohms

(HDMI IN 4 only)

 6 S video input (4-pin mini DIN)

 6 Video input (phono jack)

 6 Audio input (phono jacks)

 Audio output (Left/Right) (phono jacks)

PC  PC Input (15 Dsub) (see page 17)

G: 0.7 Vp-p, 75 ohms, non Sync on Green

B: 0.7 Vp-p, 75 ohms, non Sync on Green

R: 0.7 Vp-p, 75 ohms, non Sync on Green

HD: 1-5 Vp-p

VD: 1-5 Vp-p

 PC audio input (minijack)

 Headphones jack

 CAM (Conditional Access Module) slot



## Sound Output

10 W + 10 W (RMS)

Design and specifications are subject to change without notice.

## Optional Accessories

Wall-Mount Bracket SU-WL500 (KDL-40P30xx/KDL-37P30xx/KDL-32P30xx/KDL-40U30xx/KDL-37U30xx/KDL-32U30xx).

Wall-Mount Bracket SU-WL100 (KDL-26P30xx/KDL-26U30xx/KDL-26S30xx/KDL-26S28xx/KDL-26T28xx/KDL-26T26xx).

## PC Input Signal Reference Chart for PC

Signals	Horizontal (Pixel)	Vertical (Line)	Horizontal frequency (kHz)	Vertical frequency (Hz)	Standard
VGA	640	480	31.5	60	VGA
SVGA	800	600	37.9	60	VESA Guidelines
XGA	1024	768	48.4	60	VESA Guidelines
WXGA	1280	768	47.4	60	VESA
	1280	768	47.8	60	VESA

- This TV's PC input does not support Sync on Green or Composite Sync.
- This TV's PC input does not support interlaced signals.
- This TV's PC input supports signals in the above chart with a 60 Hz vertical frequency. For other signals, you will see the message "NO SYNC".

## PC Input Signal Reference Chart for HDMI IN 4, 5



Signals	Horizontal (Pixel)	Vertical (Line)	Horizontal frequency (kHz)	Vertical frequency (Hz)	Standard
VGA	640	480	31.5	60	VGA
SVGA	800	600	37.9	60	VESA Guidelines
XGA	1024	768	48.4	60	VESA Guidelines
WXGA	1280	768	47.4	60	VESA
WXGA	1280	768	47.8	60	VESA
WXGA	1360	768	47.7	60	VESA

# Troubleshooting

Check whether the  (standby) indicator is flashing in red.

## When it is flashing

The self-diagnosis function is activated.



- 1 Count how many  (standby) indicator flashes between each two second break.  
For example, the indicator flashes three times, then there is a two second break, followed by another three flashes, etc.
- 2 Press  on the top edge of the TV to turn it off, disconnect the mains lead, and inform your dealer or Sony service centre of how the indicator flashes (number of flashes).

## When it is not flashing



- 1 Check the items in the tables below.
- 2 If the problem still persists, have your TV serviced by qualified service personnel.

## Picture

### No picture (screen is dark) and no sound

- Check the aerial connection.
- Connect the TV to the mains, and press  on the top edge of the TV.
- If the  (standby) indicator lights up in red, press .

### No picture or no menu information from equipment connected to the scart connector

- Press / to display the connected equipment list, then select the desired input.
- Check the connection between the optional equipment and the TV.

### Double images or ghosting

- Check the aerial connection.
- Check the aerial location and direction.

### Only snow and noise appear on the screen

- Check if the aerial is broken or bent.
- Check if the aerial has reached the end of its serviceable life (three to five years in normal use, one to two years at the seaside).

### Distorted picture (dotted lines or stripes)

- Keep the TV away from electrical noise sources such as cars, motorcycles, hair-dryers or optical equipment.
- When installing optional equipment, leave some space between the optional equipment and the TV.
- Check the aerial connection.
- Keep the aerial cable away from other connecting cables.

### Picture or sound noise when viewing a TV channel

- Adjust “AFT” (Automatic Fine Tuning) to obtain better picture reception (page 28).

### Some tiny black points and/or bright points appear on the screen

- The picture of a display unit is composed of pixels. Tiny black points and/or bright points (pixels) on the screen do not indicate a malfunction.

### No colour on programmes



- Select “Reset” (page 22).

### No colour or irregular colour when viewing a signal from the 3 sockets

- Check the connection of the  3 sockets and check if each sockets are firmly seated in their respective sockets.

## Sound

### No sound, but good picture

- Press  +/- or  (Mute).
- Check if the “Speaker” is set to “TV Speaker” (page 24).

## Channels

### The desired channel cannot be selected

- Switch between digital and analogue mode and select the desired digital/analogue channel.

### Some channels are blank

- Scrambled/Subscription only channel. Subscribe to the pay TV service.
- Channel is used only for data (no picture or sound).
- Contact the broadcaster for transmission details.

### Digital channels are not displayed

- Contact a local installer to find out if digital transmissions are provided in your area.
- Upgrade to a higher gain aerial.

## General

### The TV turns off automatically (the TV enters standby mode)

- Check if the “Sleep Timer” or the “Off Time” are activated (page 26).
- If no signal is received and no operation is performed in the TV mode for 10 minutes, the TV automatically switches to standby mode.

### The TV turns on automatically

- Check if the “On Time” is activated (page 26).

### Some input sources cannot be selected

- Select “AV Preset” and cancel “Skip” of the input source (page 27).

### The remote does not function

- Replace the batteries.

### A channel cannot be added to the Favourite list

- Up to 999 channels can be stored in the Favourite list.

### HDMI equipment does not appear on “HDMI Device List”

- Check that your equipment is HDMI control compatible equipment.