

DVD Home Theatre System

Operating Instructions

DAV-DZ280



HDMI



SUPER AUDIO CD



MP3

WARNING

Caution – The use of optical instruments with this product will increase eye hazard.

Do not install the appliance in a confined space, such as a bookcase or built-in cabinet.

To reduce the risk of fire, do not cover the ventilation opening of the apparatus with newspapers, tablecloths, curtains, etc. Do not place the naked flame sources such as lighted candles on the apparatus.

To reduce the risk of fire or electric shock, do not expose this apparatus to dripping or splashing, and do not place objects filled with liquids, such as vases, on the apparatus.

Do not expose batteries or apparatus with battery-installed to excessive heat such as sunshine, fire or the like.

To prevent injury, this apparatus must be securely attached to the floor/wall in accordance with the installation instructions.

Excessive sound pressure from earphones and headphones can cause hearing loss.

Indoor use only.

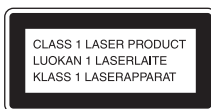

This appliance is classified as a CLASS 1 LASER product. This marking is located on the rear exterior.



Disposal of Old Electrical & Electronic Equipment (Applicable in the European Union and other European countries with separate collection systems)

This symbol on the product or on its packaging indicates that this product shall not be treated as household waste. Instead it shall be handed over to the applicable collection point for the recycling of electrical and electronic equipment. By ensuring this product is disposed of correctly, you will help prevent potential negative consequences for the environment and human health, which could otherwise be caused by inappropriate waste handling of this product. The recycling of materials will help to conserve natural resources. For more detailed information about

recycling of this product, please contact your local Civic Office, your household waste disposal service or the shop where you purchased the product.



Disposal of waste batteries (applicable in the European Union and other European countries with separate collection systems)

This symbol on the battery or on the packaging indicates that the battery provided with this product shall not be treated as household waste. By ensuring these batteries are disposed of correctly, you will help prevent potentially negative consequences for the environment and human health which could otherwise be caused by inappropriate waste handling of the battery. The recycling of the materials will help to conserve natural resources. In case of products that for safety, performance or data integrity reasons require a permanent connection with an incorporated battery, this battery should be replaced by qualified service staff only. To ensure that the battery will be treated properly, hand over the product at end-of-life to the applicable collection point for the recycling of electrical and electronic equipment. For all other batteries, please view the section on how to remove the battery from the product safely. Hand the battery over to the applicable collection point for the recycling of waste batteries. For more detailed information about recycling of this product or battery, please contact your local Civic Office, your household waste disposal service or the shop where you purchased the product.

Notice for customers: the following information is only applicable to equipment sold in countries applying EU directives.

The manufacturer of this product is Sony Corporation, 1-7-1 Konan Minato-ku Tokyo, 108-0075 Japan. The Authorized Representative for EMC and product safety is Sony Deutschland GmbH, Hedelfinger Strasse 61, 70327 Stuttgart, Germany. For any service or guarantee matters please refer to the addresses given in separate service or guarantee documents.

Precautions

On power sources

- The unit is not disconnected from the mains as long as it is connected to the AC outlet, even if the unit itself has been turned off.
- As the main plug is used to disconnect the unit from the mains, connect the unit to an easily accessible AC outlet. Should you notice an abnormality in the unit, disconnect the main plug from the AC outlet immediately.

About These Operating Instructions

- The instructions in these Operating Instructions describe the controls on the remote. You can also use the controls on the unit if they have the same or similar names as those on the remote.
- The Control Menu items may vary depending on the area.
- “DVD” may be used as a general term for a DVD VIDEO, DVD+RW/DVD+R, and DVD-RW/DVD-R.
- Measurements are expressed in feet (ft) for North American models.
- The default setting is underlined>.

Copyrights

This product incorporates copyright protection technology that is protected by U.S. patents and other intellectual property rights. Use of this copyright protection technology must be authorized by Macrovision, and is intended for home and other limited viewing uses only unless otherwise authorized by Macrovision. Reverse engineering or disassembly is prohibited.

This system incorporates with Dolby* Digital and Dolby Pro Logic (II) adaptive matrix surround decoder and the DTS** Digital Surround System.

* Manufactured under license from Dolby Laboratories.
Dolby, Pro Logic, and the double-D symbol are trademarks of Dolby Laboratories.

** Manufactured under license under U.S. Patent #'s: 5,451,942; 5,956,674; 5,974,380; 5,978,762; 6,487,535 & other U.S. and worldwide patents issued & pending. DTS and DTS Digital Surround are registered trademarks and the DTS logos and Symbol are trademarks of DTS, Inc. © 1996-2008 DTS, Inc. All Rights Reserved.

This system incorporates High-Definition Multimedia Interface (HDMI™) technology. HDMI, the HDMI logo and High-Definition Multimedia Interface are trademarks or registered trademarks of HDMI Licensing LLC.

“DVD-RW,” “DVD-R,” “DVD+RW,”
“DVD+R,” “DVD VIDEO,” and the “CD”
logos are trademarks.

“BRAVIA” is a trademark of Sony Corporation.

“PLAYSTATION” is a trademark of Sony
Computer Entertainment Inc.

“WALKMAN” and “WALKMAN” logo are
registered trademarks of Sony Corporation.

DivX[®] is a video file compression technology,
developed by DivX, Inc.

DivX, DivX Certified, and associated logos are
trademarks of DivX, Inc. and are used under
license.

About MPEG-4 Visual

THIS PRODUCT IS LICENSED UNDER THE
MPEG-4 VISUAL PATENT PORTFOLIO
LICENSE FOR THE PERSONAL AND NON-
COMMERCIAL USE OF A CONSUMER FOR
DECODING VIDEO IN COMPLIANCE
WITH THE MPEG-4 VISUAL STANDARD
(“MPEG-4 VIDEO”) THAT WAS ENCODED
BY A CONSUMER ENGAGED IN A
PERSONAL AND NON-COMMERCIAL
ACTIVITY AND/OR WAS OBTAINED
FROM A VIDEO PROVIDER LICENSED BY
MPEG LA TO PROVIDE MPEG-4 VIDEO.
NO LICENSE IS GRANTED OR SHALL BE
IMPLIED FOR ANY OTHER USE.
ADDITIONAL INFORMATION INCLUDING
THAT RELATING TO PROMOTIONAL,
INTERNAL AND COMMERCIAL USES
AND LICENSING MAY BE OBTAINED
FROM MPEG LA, LLC. SEE [HTTP://
WWW.MPEGLA.COM](http://www.mpegla.com)

Table of Contents

About These Operating Instructions	3
Playable Discs	6

Getting Started

Step 1: Installing the System.....	11
Step 2: Connecting the System... ..	15
Step 3: Performing the Quick Setup.....	21
Step 4: Selecting the Source.....	23
Step 5: Enjoying Surround Sound.....	24

Disc

Playing a Disc	27
Using Play Mode.....	32
Searching/Selecting Disc Contents	35
Playing MP3 Files/JPEG Image Files... ..	37
Enjoying Video Files	41
Adjusting the Delay Between the Picture and Sound	43
Restricting Playback of the Disc.....	43
Changing the System Settings by Using the Setup Display	45

Tuner

Presetting Radio Stations	52
Listening to the Radio.....	53
Using the Radio Data System (RDS)....	54

Control for HDMI/External

Audio Device

Using the Control for HDMI Function for “BRAVIA” Sync	55
Playing Back Files of a USB Device	57
Transferring Songs onto a USB Device	65
Using a Sony Ericsson Mobile Phone	69
Using the DIGITAL MEDIA PORT Adapter	69



















Other Operations

Getting Optimal Surround Sound for a Room	71
Controlling the TV with the Supplied Remote	72
Using the Sound Effect.....	72
Selecting the Effect to Suit the Source.....	73
Changing the Input Level of the Sound from Connected Components.....	74
Using the Sleep Timer	74
Changing the Brightness of the Front Panel Display.....	75
Viewing Information About the Disc ...	75
Returning to the Default Settings	78

Additional Information

Precautions.....	79
Notes about the Discs	80
Troubleshooting.....	81
Self-diagnosis Function	89
Specifications.....	90
Glossary	91
Playback priority of file types	93
Language Code List.....	94
Index to Parts and Control	95
Guide to the Control Menu Display	99
Index	103

Playable Discs

Type	Disc logo	Characteristics	Icon
DVD VIDEO	     	<ul style="list-style-type: none"> • DVD VIDEO • DVD-R/DVD-RW in DVD VIDEO format or video mode • DVD+R/DVD+RW in DVD VIDEO format 	
VR (Video Recording) mode	 	<ul style="list-style-type: none"> • DVD-R/DVD-RW in VR (Video Recording) mode (except for DVD-R DL) 	
VIDEO CD		<ul style="list-style-type: none"> • VIDEO CD (Ver. 1.1 and 2.0 discs) • Super VCD • CD-R/CD-RW/CD-ROM in video CD format or Super VCD format 	
Super Audio CD	 SUPER AUDIO CD	<ul style="list-style-type: none"> • Super Audio CD 	
CD		<ul style="list-style-type: none"> • Audio CD • CD-R/CD-RW in audio CD format 	
DATA CD	–	<ul style="list-style-type: none"> • CD-R/CD-RW/CD-ROM in DATA CD format, containing MP3 files¹⁾, JPEG image files²⁾, DivX video files, and MPEG4 video files, and conforming to ISO 9660³⁾ Level 1/Level 2, or Joliet (extended format) 	
DATA DVD	–	<ul style="list-style-type: none"> • DVD-ROM/DVD-R/DVD-RW/DVD+R/DVD+RW in DATA DVD format, containing MP3 files¹⁾, JPEG image files²⁾, DivX video files, and MPEG4 video files, and conforming to UDF (Universal Disk Format) 	

¹⁾MP3 (MPEG1 Audio Layer 3) is a standard format defined by ISO/MPEG for compresses audio data. MP3 files must be in MPEG1 Audio Layer 3 format.

²⁾JPEG image files must conform to the DCF image file format. (DCF “Design rule for Camera File system”: Image standards for digital cameras regulated by Japan Electronics and Information Technology Industries Association (JEITA).)

³⁾A logical format of files and folders on CD-ROMs, defined by ISO (International Organization for Standardization).

Notes on discs

This product is designed to playback discs that conform to the Compact Disc (CD) standard. DualDiscs and some of the music discs encoded with copyright protection technologies do not conform to the Compact Disc (CD) standard, therefore, these discs may not be playable by this product.

Example of discs that the system cannot play

The system cannot play the following discs:

- CD-ROM/CD-R/CD-RW other than those recorded in the formats listed on page 6
- CD-ROM recorded in PHOTO CD format
- Data part of CD-Extra
- CD Graphics disc
- DVD Audio
- DATA DVD that does not contain MP3 files, JPEG image files, DivX video files, or MPEG4 video files
- DVD-RAM
- Blu-ray Disc

Also, the system cannot play the following discs:

- A DVD VIDEO with a different region code (page 8)
- A disc that has a non-standard shape (e.g., card, heart)
- A disc with paper or stickers on it
- A disc that has the adhesive of cellophane tape or a sticker still left on it

Note about CD-R/CD-RW/DVD-R/DVD-RW/DVD+R/DVD+RW

In some cases, CD-R/CD-RW/DVD-R/DVD-RW/DVD+R/DVD+RW cannot be played on this system due to the recording quality or physical condition of the disc, or the characteristics of the recording device and authoring software.

The disc will not play if it has not been correctly finalized. For more information, refer to the operating instructions for the recording device.

Note that some playback functions may not work with some DVD+RWs/DVD+Rs, even if they have been correctly finalized. In this case, view the disc by normal playback. Also some DATA CDs/DATA DVDs created in Packet Write format cannot be played.

About Multi Session CD

- This system can play a Multi Session CD when an MP3 file is contained in the first session. Any subsequent MP3 files recorded in later sessions can also be played back.
- This system can play a Multi Session CD when a JPEG image file is contained in the first session. Any subsequent JPEG image files recorded in later sessions can also be played back.
- If MP3 files and JPEG image files in music CD format or video CD format are recorded in the first session, only the first session will be played back.

Region code

Your system has a region code printed on the rear of the unit and will only play a DVD labeled with the same region code.

A DVD VIDEO labeled  will also play on this system.

If you try to play any other DVD VIDEO, the message [Playback prohibited by area limitations.] will appear on the TV screen. Depending on the DVD VIDEO, no region code indication may be given even though playing the DVD VIDEO is prohibited by area restrictions.

Note about playback operations of a DVD or VIDEO CD

Some playback operations on a DVD or VIDEO CD may be intentionally set by software producers. Since this system will play a DVD or VIDEO CD according to the disc contents the software producers designed, some playback features may not be available. Be sure to read the operating instructions supplied with the DVD or VIDEO CD.

Unpacking

- Front speakers (2)

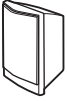

- Center speaker (1)



- Surround speakers (2)



- Subwoofer (1)

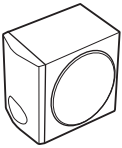

- FM wire antenna (aerial) (1)

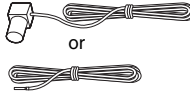

- Speaker cords (6, red/white/green/gray/blue/purple)



- Remote commander (remote) (1)

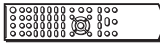

- R6 (size AA) batteries (2)



- Foot pads (1 set)



- Operating Instructions
- Quick Setup Guide

Inserting batteries into the remote

Insert two R6 (size AA) batteries (supplied) by matching the ⊕ and ⊖ ends on the batteries to the markings inside the compartment. To use the remote, point it at the remote sensor  on the unit.

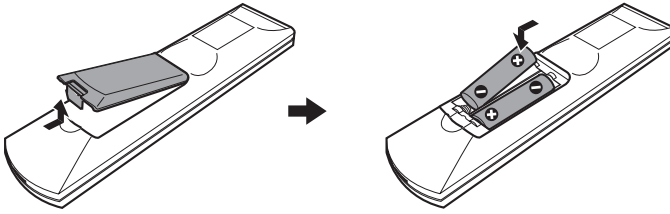
**Note**

- Do not leave the remote in an extremely hot or humid place.
- Do not use a new battery with an old one.
- Do not drop any foreign object into the remote casing, particularly when replacing the batteries.
- Do not expose the remote sensor to direct sunlight or lighting apparatus. Doing so may cause a malfunction.
- If you do not intend to use the remote for an extended period of time, remove the batteries to avoid possible damage from battery leakage and corrosion.

Step 1: Installing the System

Positioning the system

For the best possible surround sound, place all speakers at the same distance from the listening position (A). The distance can be between 1.0 to 7.0 meters.

If you cannot place the center speaker and surround speakers at the same distance as (A), you can move the center speaker up to 1.6 meters closer to the listening position (B), and the surround speakers up to 5.0 meters closer to the listening position (C).

The subwoofer can be placed anywhere in the room.

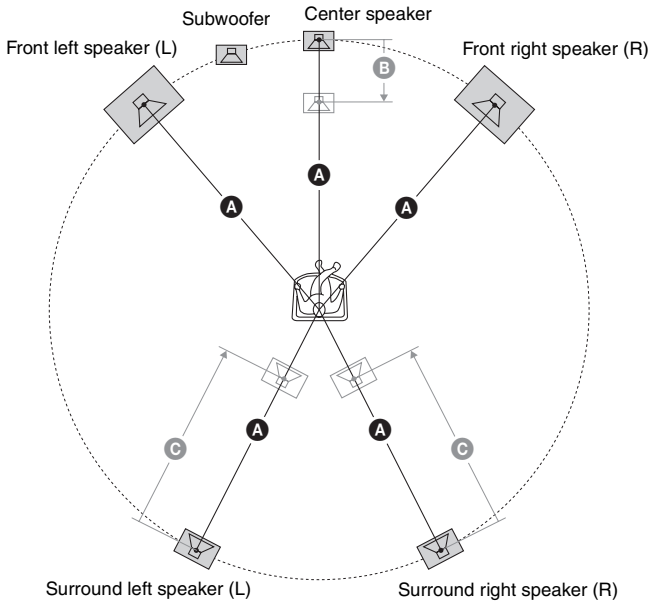

Note

- Use caution when placing the speakers and/or speaker stands attached to the speakers on a specially treated (waxed, oiled, polished, etc.) floor, as staining or discoloration may result.
- Do not lean or hang on a speaker, as it may fall down.

Attaching the foot pads to the subwoofer

Attach the foot pads (supplied) to the bottom of the subwoofer to stabilize the subwoofer and prevent it from slipping.

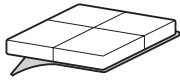

Remove the foot pads from the protective cover.

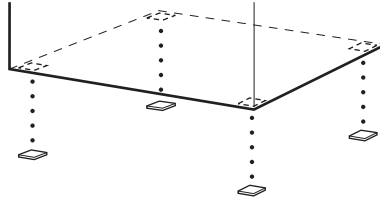

Installing the speakers on a wall

Caution

- Contact a screw shop or installer for information regarding the wall material or screws to be used.
- Use screws that are suitable for the wall material and strength. As a plaster board wall is especially fragile, attach the screws securely to a beam. Install the speakers on a vertical and flat wall where reinforcement is applied.
- Sony is not responsible for accidents or damage caused by improper installation, insufficient wall strength or improper screw installation, natural calamity, etc.

Before installing the speakers on a wall, connect the speaker cord to the speaker.

Be sure to match the speaker cords to the appropriate terminals on the speakers: the speaker cord with the color tube to \oplus , and the speaker cord without the color tube to \ominus .



Color tube
 Front left speaker (L): White
 Front right speaker (R): Red
 Center speaker: Green
 Surround left speaker (L): Blue
 Surround right speaker (R): Gray

- 1 Prepare screws (not supplied) that are suitable for the hole on the back of each speaker. See the illustrations below.**

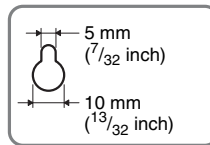
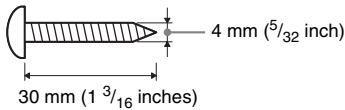

Hole on the back of the speaker

- 2 Fasten the screws to the wall.**

For the center speaker

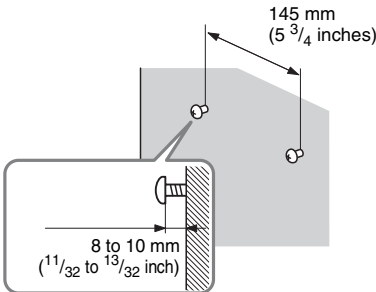

For the other speakers

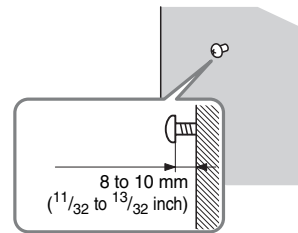

3 Hang the speakers on the screws.

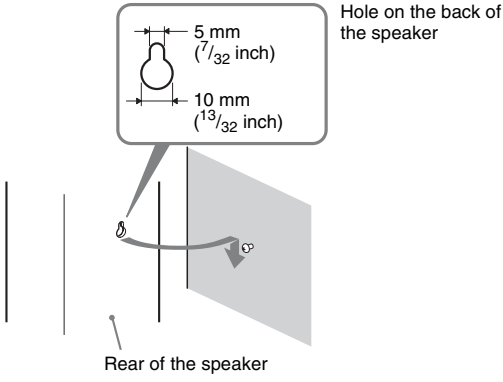

Step 2: Connecting the System

For connecting the system, read the information on the following pages.

Note

- When you connect another component with a volume control, turn down the volume of the other components to a level where sound is not distorted.

Connecting the speakers

The connector of the speaker cords and the color tube are color-coded depending on the type of speaker. Connect the speaker cords to match the color of the SPEAKER jacks of the unit.

Be sure to match the speaker cords to the appropriate terminals on the speakers: the speaker cord with the color tube to \oplus , and the speaker cord without the color tube to \ominus . Do not catch the speaker cord insulation (rubber covering) in the speaker terminals.

To connect speaker cords to the unit

When connecting to the unit, insert the connector until it clicks.

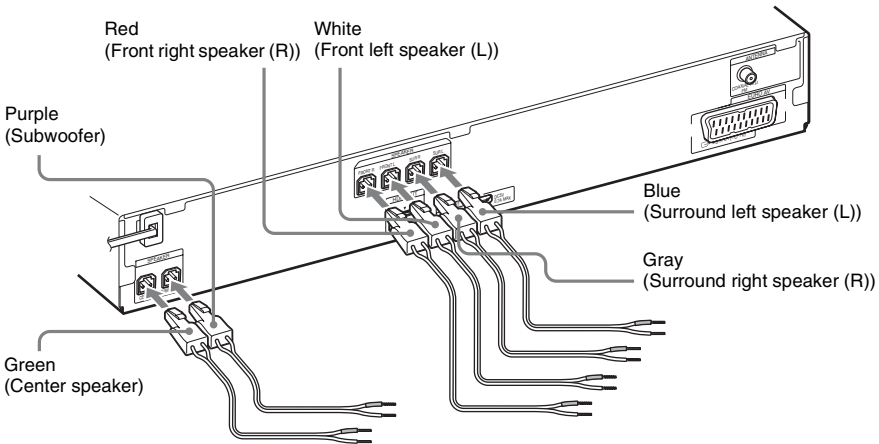

To connect speaker cords to the speaker

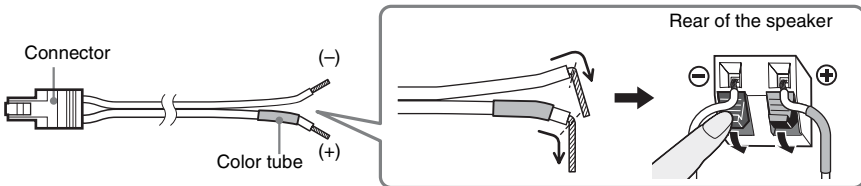

Connecting the TV

Depending on the jacks on your TV, select the connection method.

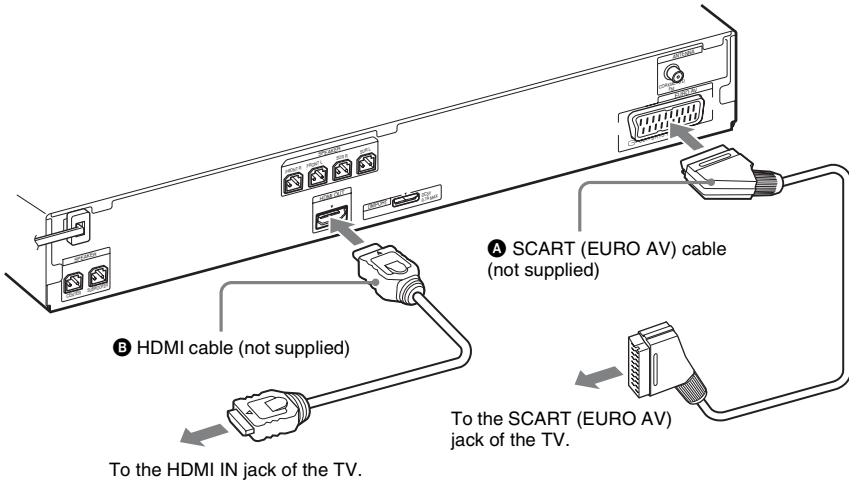

Method 1: SCART (EURO AV) cable (A) connection

This connection sends both video and audio signals.

Method 2: HDMI* cable (B) and SCART (EURO AV) cable (A) connection

If your TV has an HDMI jack, connect to the TV both with an HDMI cable and SCART (EURO AV) cable. Picture quality will be improved compared to using only the SCART (EURO AV) connection. When connecting with the HDMI cable, you need to select the type of output signal (page 22).

To view images from the DIGITAL MEDIA PORT adapter, you need to connect to the TV with the SCART (EURO AV) cable. Video signals from the DIGITAL MEDIA PORT adapter are not output via the HDMI OUT jack.

* HDMI (High-Definition Multimedia Interface)

Tip

- When you connect the system and a TV with the “BRAVIA” Sync function via an HDMI cable, the “BRAVIA” Sync function is enabled. In this case, set [CONTROL FOR HDMI] in [HDMI SETUP] to [ON] (page 47).

Connecting the other components

You can enjoy connected components via the system's speakers.

Portable audio source (not supplied): **C**

USB device (not supplied): **D**

DIGITAL MEDIA PORT adapter (not supplied): **E**

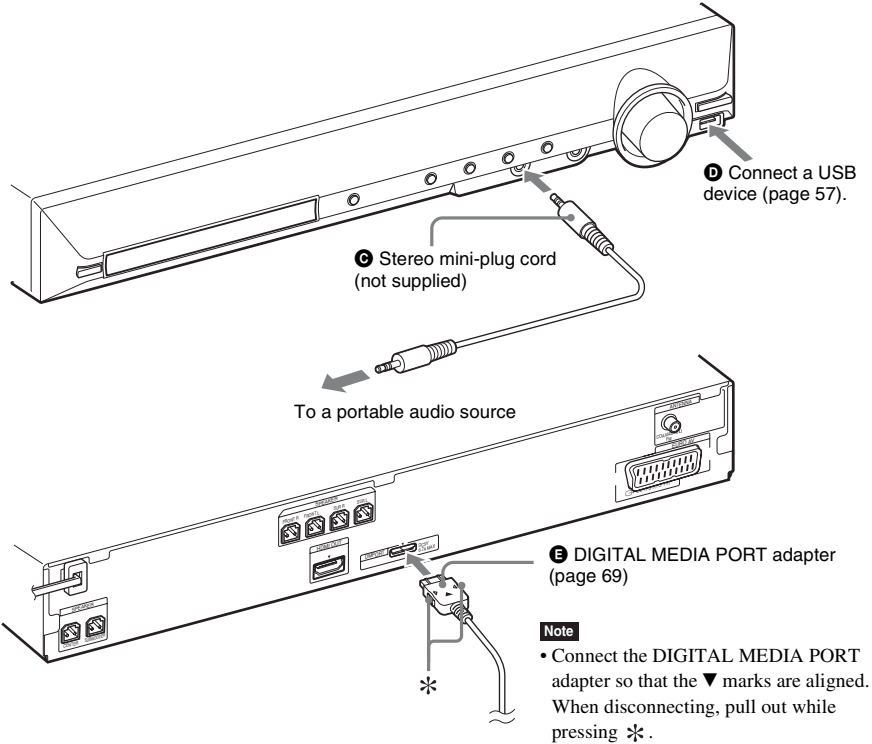

If your TV has multiple audio/video inputs

You can enjoy sound with the speakers of the system through the connected TV. Connect the components as follows.

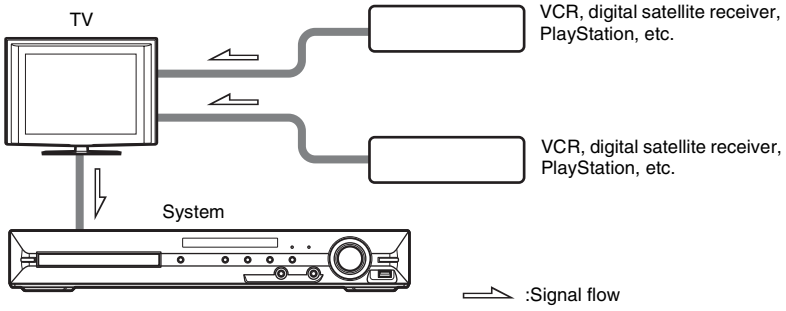

Select the component on the TV. For details, refer to the operating instructions of the TV.

If the TV does not have multiple audio/video inputs, a switcher will be necessary to receive sound from more than one component.

Connecting the antenna (aerial)

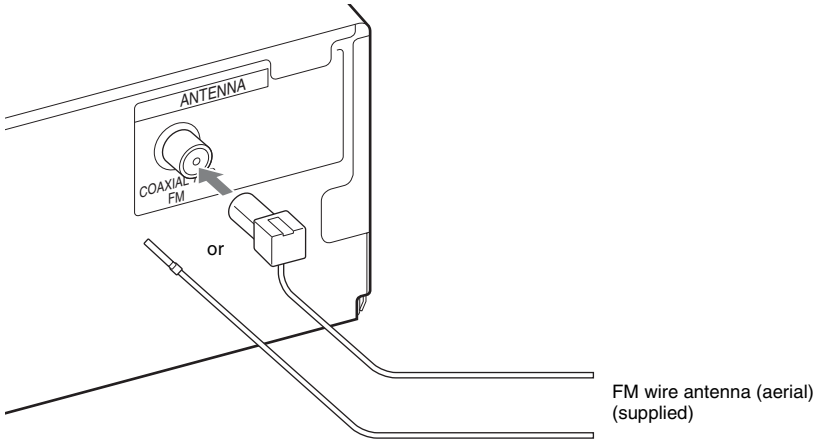

Note

- Be sure to fully extend the FM wire antenna (aerial).
- After connecting the FM wire antenna (aerial), keep it as horizontal as possible.

Tip

- If you have poor FM reception, use a 75-ohm coaxial cable (not supplied) to connect the unit to an outdoor FM antenna (aerial) as shown below.

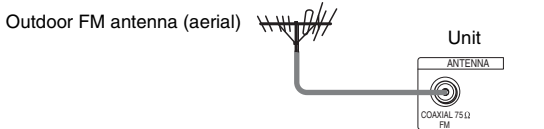

Connecting the AC power cord (mains lead)

Before connecting the AC power cord (mains lead) of the unit to a wall outlet (mains), connect all the speakers to the unit.

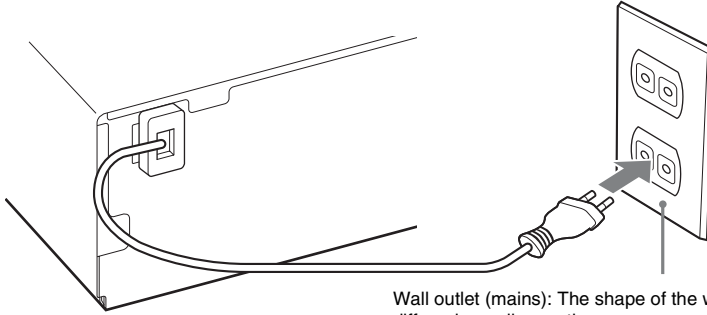

Wall outlet (mains): The shape of the wall outlet (mains) differs depending on the area.

About the demonstration

After connecting the AC power cord (mains lead), the demonstration appears in the front panel display.

Setting the demonstration mode to on/off

- 1** Press **I/⏻** on the unit.
The system turns on.
- 2** Press **SYSTEM MENU**.
- 3** Press **↑/↓** repeatedly until “DEMO” appears in the front panel display, then press **⊕** or **→**.
- 4** Press **↑/↓** to select a setting.
 - “DEMO ON”: On.
 - “DEMO OFF”: Off.
- 5** Press **⊕**.
The setting is made.
- 6** Press **SYSTEM MENU**.
The system menu turns off.

Tip

- When you purchase the system new, or if the system is at its factory default settings (ex., after performing “COLD RESET” (page 78)), you can turn off the demonstration simply by pressing **I/⏻** on the remote.

Step 3: Performing the Quick Setup

Follow the Steps below to make the basic adjustments for using the system.
Displayed items vary depending on the area.

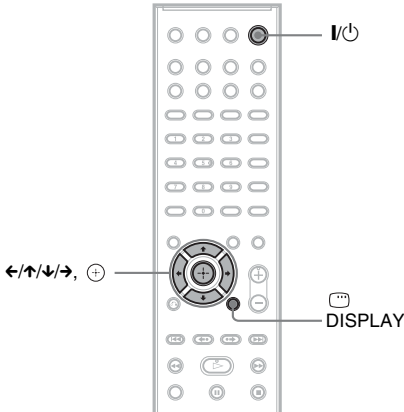

1 Turn on the TV.

2 Press I/O.

Note

- Make sure that the function is set to “DVD” (page 23).

3 Switch the input selector on your TV so that the signal from the system appears on the TV screen.

[Press [ENTER] to run QUICK SETUP.] appears at the bottom of the TV screen. If this message does not appear, recall the Quick Setup display (page 22).

4 Press + without inserting a disc.

The Setup Display for selecting the language used in the on-screen display appears.

LANGUAGE SETUP	
OSD:	ENGLISH
MENU:	ENGLISH
AUDIO:	FRENCH
SUBTITLE:	SPANISH
	PORTUGUESE

5 Press \uparrow/\downarrow to select a language, then press +.

The Setup Display for selecting the aspect ratio of the TV to be connected appears.

VIDEO SETUP	
TV TYPE:	16:9
LINE:	16:9
PAUSE MODE:	4:3 LETTER BOX
	4:3 PAN SCAN

6 Press \uparrow/\downarrow to select the setting that matches your TV type, then press +.

- [16:9]: For a wide-screen TV or a 4:3 standard TV with a wide-screen mode (page 47)
- [4:3 LETTER BOX] or [4:3 PAN SCAN]: For a 4:3 standard TV (page 47)

The Setup Display for selecting the output method for video signals from the EURO AV \hookrightarrow OUTPUT (TO TV) jack on the rear panel of the unit appears.

VIDEO SETUP	
TV TYPE:	16:9
LINE:	VIDEO
PAUSE MODE:	VIDEO
	RGB

7 Press \uparrow/\downarrow to select the output method for video signals, then press +.

- [VIDEO]: Outputs video signals.
- [RGB]: Outputs RGB signals.

Note

- If your TV does not accept RGB signals, no picture appears on the TV screen even if you select [RGB]. Refer to the operating instructions supplied with your TV.

The Setup Display for the Control for HDMI function appears.

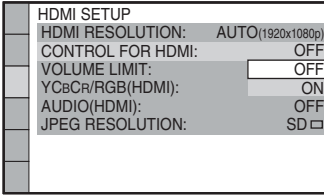

8 Press \uparrow/\downarrow to select the setting, then press \oplus .

- [OFF]: The Control for HDMI function is set to off.
- [ON]: The Control for HDMI function (page 55) is set to on.

The Setup Display for selecting the speaker formation appears.

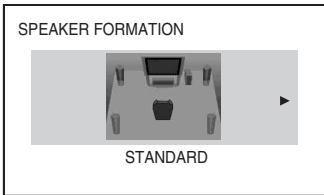

9 Press \leftarrow/\rightarrow to select the speaker formation image as the speakers are actually positioned, then press \oplus .

For details, see “Getting Optimal Surround Sound for a Room” (page 71).

Quick Setup is finished. All connections and setup operations are complete.

To quit the Quick Setup

Press \square DISPLAY in any Step.

To recall the Quick Setup display

- 1 Press FUNCTION $+/-$ repeatedly until “DVD” appears in the front panel display.**
- 2 Press \square DISPLAY while the system is in stop mode.**
The Control Menu display appears on the TV screen.

3 Press \uparrow/\downarrow to select \square [SETUP], then press \oplus .

The options for [SETUP] appear.

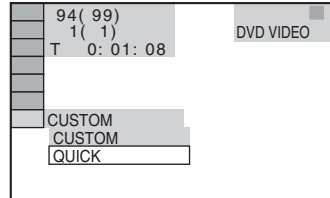

4 Press \uparrow/\downarrow to select [QUICK], then press \oplus .

The Quick Setup display appears.

Setting the type of video output to match your TV

Depending on the connection of the TV (page 16), select the type of video output of the system.

To select the type of video signal output from the HDMI OUT jack

When you connect the unit and the TV with an HDMI cable, select the type of video signals output from the HDMI OUT jack.

For details, refer also to the operating instructions supplied with the TV/projector, etc.

- 1 Press FUNCTION $+/-$ repeatedly until “DVD” appears in the front panel display.**
- 2 Press \square DISPLAY while the system is in stop mode.**
The Control Menu display appears on the TV screen.
- 3 Press \uparrow/\downarrow to select \square [SETUP], then press \oplus .**
The options for [SETUP] appear.
- 4 Press \uparrow/\downarrow to select [CUSTOM], then press \oplus .**
The Setup Display appears.
- 5 Press \uparrow/\downarrow to select [HDMI SETUP], then press \oplus .**

The options for [HDMI SETUP] appear.

- 6** Press \uparrow/\downarrow to select [HDMI RESOLUTION], then press \oplus .
- 7** Press \uparrow/\downarrow to select the desired setting, then press \oplus .

- [AUTO (1920 × 1080p)]: The system outputs the optimal video signal for the connected TV.
- [1920 × 1080i]: The system outputs 1920 × 1080i* video signals.
- [1280 × 720p]: The system outputs 1280 × 720p* video signals.
- [720 × 480p]**: The system outputs 720 × 480p* video signals.

* i: interlace, p: progressive

** Depending on the area, [720 × 480/576p] may appear.

Step 4: Selecting the Source

You can select the playback source.

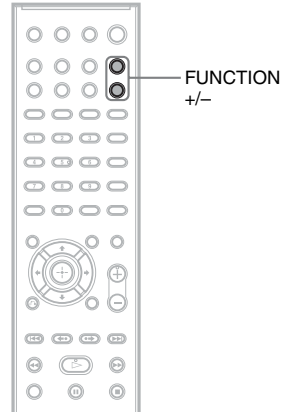

Press FUNCTION +/- repeatedly until the desired function appears in the front panel display.

Each time you press FUNCTION +/-, the function changes as follows.

“DVD” ↔ “TUNER FM” ↔ “USB” ↔
 “TV” ↔ “DMPORT” ↔ “AUDIO” ↔ ...

Function	Source
“DVD”	Disc that is played by the system
“TUNER FM”	FM radio (page 52)
“USB”	USB device (page 57)
“TV”	TV
“DMPORT”	DIGITAL MEDIA PORT adapter (page 69)
“AUDIO”	Portable audio source that is connected to the AUDIO IN jack on the front panel

Step 5: Enjoying Surround Sound

You can enjoy surround sound simply by selecting one of the system's pre-programmed decoding modes. They bring the exciting and powerful sound of movie theaters into your home.

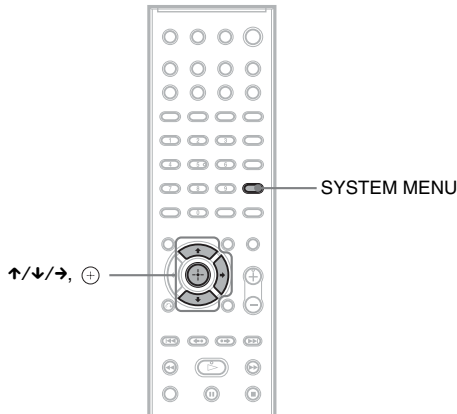

Enjoying TV sound with the 5.1 channel surround sound effect

- 1** Press **SYSTEM MENU**.
- 2** Press **↑/↓** repeatedly until “DEC. MODE” appears in the front panel display, then press **+** or **→**.
- 3** Press **↑/↓** repeatedly until “PRO LOGIC” appears in the front panel display.
- 4** Press **+**.

The setting is made.

- 5** Press **SYSTEM MENU**.

The system menu turns off.

Note

- When TV program sound is monaural, sound is output only from the center speaker.

Selecting surround sound effects based on your listening preference

- 1** Press **SYSTEM MENU**.
 - 2** Press **↑/↓** repeatedly until “DEC. MODE” appears in the front panel display, then press **+** or **→**.
 - 3** Press **↑/↓** repeatedly until the surround sound effect you want appears in the front panel display.
- See the table below for surround sound effect descriptions.

4 Press .

The setting is made.

5 Press SYSTEM MENU.

The system menu turns off.

About speaker output

The table below describes the options when you connect all the speakers to the unit and you set [SPEAKER FORMATION] to [STANDARD] (page 71).

The default setting is “A.F.D. STD” (when connecting the headphones to the unit, the default setting is “HP 2CH”).

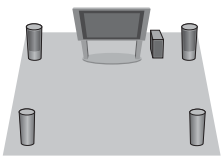
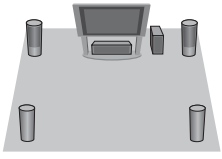
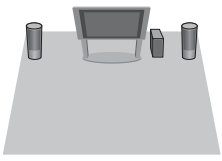
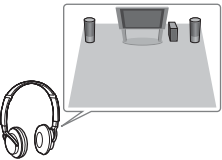
Sound from	Surround effect	Effect
Depending on the source.	“A.F.D. STD” (AUTO FORMAT DIRECT STANDARD)	The system discriminates the sound format of the source and presents sound as it was recorded/encoded.
	“A.F.D. MULTI” (AUTO FORMAT DIRECT MULTI)	<ul style="list-style-type: none"> • 2 channel source: The system outputs 2 channel sound from the front and surround speakers by assigning the 2 channel sound to the surround left and right channels. • Multi-channel source: The system outputs sound from the speakers depending on the number of channels of the source.
	“PRO LOGIC” “PLII MOVIE” “PLII MUSIC”	<ul style="list-style-type: none"> • 2 channel source: The system simulates surround sound from 2 channel sources and outputs sound from all the speakers. <ul style="list-style-type: none"> – “PRO LOGIC” performs Dolby Pro Logic decoding. – “PLII MOVIE” performs Dolby Pro Logic II movie mode decoding. – “PLII MUSIC” performs Dolby Pro Logic II music mode decoding. • Multi-channel source: The system outputs sound from the speakers depending on the number of channels of the source.
	“2CH STEREO”	The system outputs the sound from the front speakers and subwoofer regardless of sound format or number of channels. Multi-channel surround formats are downmixed to 2 channels.
	“HP 2CH” (HEADPHONE 2 CHANNEL STEREO)	The system outputs the sound from the headphones regardless of sound format or number of channels. Multi-channel surround formats are downmixed to 2 channels.

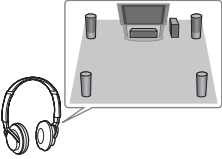
Sound from	Surround effect	Effect
	"HP VIRTUAL" (HEADPHONE VIRTUAL)	The system outputs the sound from the headphones by adding a surround effect regardless of sound format or number of channels.

To turn the surround effect off

Select "A.F.D. STD," "2CH STEREO," or "HP 2CH" for "DEC. MODE."

Note

- When the bilingual broadcast sound is input, "PRO LOGIC," "PLII MOVIE," and "PLII MUSIC" are not effective.
- You cannot select the decoding mode while the system is loading a disc.
- You cannot select the decoding mode when the unit is reading the files in a USB device or transferring songs.
- Depending on the input stream, the decoding mode may not be effective.
- When you select "A.F.D. MULTI," the surround or stereo effect may not be effective. In this case, select "A.F.D. STD," "PRO LOGIC," "PLII MOVIE," or "PLII MUSIC."

Playing a Disc

DVD-V DVD-VR VIDEO CD Super Audio CD C D
DATA-CD DATA DVD

Depending on the DVD VIDEO or VIDEO CD, some operations may be different or restricted. Refer to the operating instructions supplied with your disc.

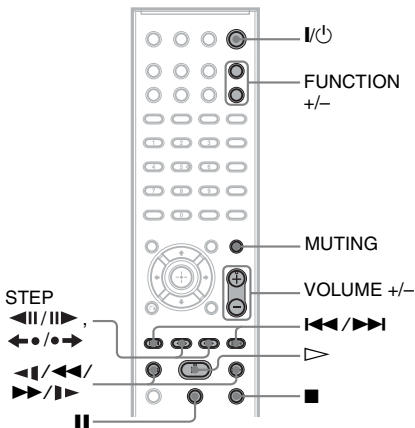
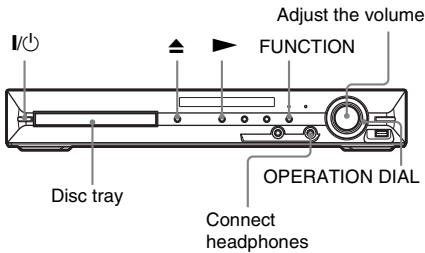

- 1 Turn on your TV.**
- 2 Switch the input selector on the TV to this system.**
- 3 Press I/⏻.**
The system turns on.
Unless the system is set to "DVD," press FUNCTION +/- to select "DVD."

- 4 Press \blacktriangle on the unit to open the disc tray, and place a disc on the tray.**
Place one disc on the tray, and then press \blacktriangle .

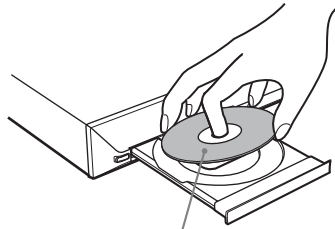

With the label side up.

Note

- When you play an 8 cm disc, place it on the inner circle of the tray. Be careful that the disc is not skewed on the inner circle of the tray.
- Do not place more than one disc on the tray.

- 5 Press \blacktriangleright .**

The system starts playback (continuous play).

- 6 Adjust the volume by using VOLUME +/- on the remote or the VOLUME control on the unit.**

The volume level appears on the TV screen and in the front panel display.

Note

- When you set the Control for HDMI function to on, the TV that is connected to the system with an HDMI cable can be sync-operated with the system. For details, see "Using the Control for HDMI Function for "BRAVIA" Sync" (page 55).

To turn the system off

Press I/⏻ while the system is on. The system enters standby mode.

To save power in standby mode

Press I/⏻ while the system is on.

To enter power saving mode, make sure that the system is in the following status.

- "DEMO" is set to "OFF" (page 20).
- [CONTROL FOR HDMI] is set to [OFF] (page 55).

To use the headphones

Connect the headphones to the PHONES jack on the unit. The sound of the system is muted.

Other operations

To	Press
Stop	■
Pause	⏸
Resume play after pause	⏸ or ▷
Go to the next chapter, track, or scene ¹⁾	▶▶
Go back to the preceding chapter, track, or scene ¹⁾	◀◀ twice in a second. When you press ◀◀ once, you can go to the beginning of the current chapter, track, or scene.
Find the desired chapter, track, or scene using OPERATION DIAL on the unit ¹⁾	Turning OPERATION DIAL clockwise is the same operation as pressing ▶▶. Turning OPERATION DIAL counterclockwise is the same operation as pressing ◀◀.
Turn off the sound temporarily	MUTING. To cancel, press it again or press VOLUME + to adjust the sound volume.
Stop play and remove the disc	▲ on the unit.
Locate a point quickly by playing a disc in fast forward or fast reverse (Scan) ¹⁾	▶▶/▶▶ or ◀◀/◀◀ while playing a disc. Each time you press ▶▶/▶▶ or ◀◀/◀◀ during scan, the playback speed changes. To return to normal speed, press ▷. Actual speeds may differ with some discs.
Watch frame by frame (Slow-motion Play) ²⁾	▶▶/▶▶ or ◀◀/◀◀ ³⁾ while the system is in pause mode. Each time you press ▶▶/▶▶ or ◀◀/◀◀ ³⁾ during Slow-motion Play, the playback speed changes. Two speeds are available. To return to normal playback speed, press ▷.

To	Press
Play one frame at a time (Freeze Frame) ²⁾⁴⁾⁵⁾	STEP II▶ to go to the next frame while the system is in pause mode. Press STEP ◀II to go to the preceding frame while the system is in pause mode (DVD VIDEO/DVD-R/DVD-RW only). To return to normal playback, press ▷.
Replay the previous scene (10 seconds before) ⁶⁾	◀● (instant replay) during playback.
Briefly fast forward the current scene (30 seconds ahead) ⁷⁾	●▶ (instant advance) during playback.

¹⁾Except for JPEG image files.

²⁾DVD VIDEO/DVD-R/DVD-RW/VIDEO CD only.

³⁾Except for VIDEO CDs.

⁴⁾You cannot search for a still picture on a DVD-VR.

⁵⁾For a DATA CD/DATA DVD, this function works only for video files.

⁶⁾DVD VIDEO/DVD-RW/DVD-R only. The button can be used except for video files.

⁷⁾DVD VIDEO/DVD-RW/DVD-R/DVD+RW/DVD+R only. The button can be used except for video files.

Displaying multi-angles and subtitles

To change the angles

DVD-V

If various angles (multi-angles) for a scene are recorded on a DVD VIDEO, you can change the viewing angle.

Press ANGLE during playback to select the desired angle.

To display the subtitles

DVD-V DVD-VR DATA-CD DATA DVD

If subtitles are recorded on a disc, you can turn the subtitles on/off during playback. If multilingual subtitles are recorded on the disc, you can change the subtitle language during

playback, or turn the subtitles on/off whenever you want.

Press SUBTITLE during playback to select the desired subtitle language.

Note

- You can select the subtitles if the DivX video file has an “.avi” or “.divx” extension and contains subtitle information within the same file.

Changing the sound

DVD-V

DVD-VR

VIDEO CD

CD

DATA-CD

DATA DVD

When the system is playing a DVD VIDEO or DATA CD/DATA DVD (DivX video files) recorded in multiple audio formats (PCM, Dolby Digital, MPEG audio, or DTS), you can change the audio format. If the DVD VIDEO is recorded with multilingual tracks, you can also change the language.

With a VIDEO CD, CD, DATA CD, or DATA DVD, you can select the sound from the right or left channel and listen to the sound of the selected channel through both the right and left speakers.

You cannot change the sound for a Super Audio CD.

Press AUDIO repeatedly during playback to select the desired audio signal.

■ DVD VIDEO

Depending on the DVD VIDEO, the choice of language varies.

When 4 digits are displayed, they indicate a language code. See “Language Code List” (page 94) to confirm which language the code represents. When the same language is displayed two or more times, the DVD VIDEO is recorded in multiple audio formats.

■ DVD-VR

The types of sound tracks recorded on a disc are displayed.

Example:

- [1: MAIN] (main sound)
- [1: SUB] (sub sound)
- [1: MAIN+SUB] (main and sub sound)
- [2: MAIN]

- [2: SUB]
- [2: MAIN+SUB]

■ VIDEO CD/CD/DATA CD (MP3 file)/DATA DVD (MP3 file)

- [STEREO]: The standard stereo sound.
- [1/L]: The sound of the left channel (monaural).
- [2/R]: The sound of the right channel (monaural).

■ DATA CD (DivX video file)/DATA DVD (DivX video file)

The choice of DATA CD or DATA DVD audio signal formats differs, depending on the DivX video file contained on the disc. The format appears on the TV screen.

■ Super VCD

- [1:STEREO]: The stereo sound of audio track 1.
- [1:1/L]: The sound of the left channel of audio track 1 (monaural).
- [1:2/R]: The sound of the right channel of audio track 1 (monaural).
- [2:STEREO]: The stereo sound of audio track 2.
- [2:1/L]: The sound of the left channel of audio track 2 (monaural).
- [2:2/R]: The sound of the right channel of audio track 2 (monaural).

Checking the audio signal format

DVD-V

DATA-CD

DATA DVD

If you press AUDIO repeatedly during playback, the format of the current audio signal (PCM, Dolby Digital, DTS, etc.) appears as shown below.

■ DVD

Example:

Dolby Digital 5.1 channel

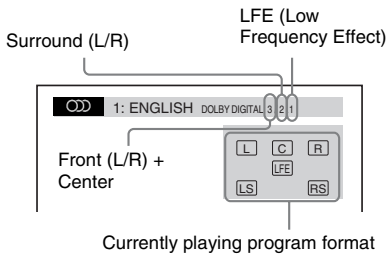

Example:

Dolby Digital 3 channel

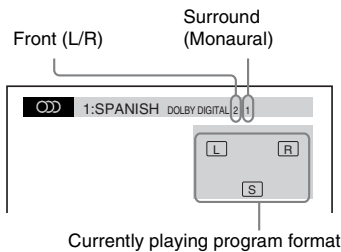

■ DATA CD (video file)/DATA DVD (video file)

Example:

MP3 audio

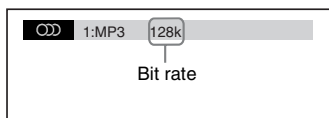

Selecting a playback area for a Super Audio CD

Super Audio CD

Some Super Audio CDs consist of a 2 channel playback area and a multi-channel playback area. You can select the playback area you want to listen to.

1 Press **DISPLAY** while the system is in stop mode.

The Control Menu display appears on the TV screen.

2 Press **↑/↓** to select **[MULTI/2CH]**, then press **+**.

The options for [MULTI/2CH] appear.

3 Press **↑/↓** to select the desired setting and press **+**.

- [MULTI]: You can play the multi-channel playback area.
- [2CH]: You can play the 2 channel playback area.

Note

- When the Super Audio CD does not have a multi-channel playback area, you cannot select the playback area.

Changing a playback layer for a hybrid Super Audio CD

Super Audio CD

Some Super Audio CDs consist of a Super Audio CD layer and a CD layer. You can change the playback layer you want to listen to.

1 Press **DISPLAY** while the system is in stop mode.

The Control Menu display appears on the TV screen.

2 Press **↑/↓** to select **[SUPER AUDIO CD/CD LAYER]**, then press **+**.

■ When the current layer is the CD layer [SUPER AUDIO CD] appears.

■ When the current layer is the Super Audio CD layer [CD] appears.

3 Press **+** to change the layer.

• [SUPER AUDIO CD]: You can play the Super Audio CD layer.

When the system is playing a Super Audio CD layer, "SA-CD" lights up in the front panel display.

- [CD]: You can play the CD layer.
When the system is playing a CD layer, “CD” lights up in the front panel display.

Note

- Each play mode function works only within the selected layer or playback area.
- When you select a CD layer, you cannot change playback areas.
- Super Audio CD audio signals are not output from the HDMI OUT jack.

Playing a VIDEO CD with PBC functions (Ver. 2.0)

(PBC Playback)

VIDEO CD

With PBC (Playback Control) functions, you can enjoy simple interactive operations, search functions, and other such operations. PBC playback allows you to play a VIDEO CD interactively by following the menu on the TV screen.

- 1 Start playing a VIDEO CD with PBC functions.**
The menu for your selection appears.
- 2 Select the item number you want using the number buttons.**
If you make a mistake, press CLEAR to cancel the number.
- 3 Press \oplus .**
- 4 Follow the instructions in the menu for interactive operations.**
Refer to the operating instructions supplied with the disc, as the operating procedure may differ depending on the VIDEO CD.

To go back to the menu

Press \curvearrowright RETURN.

Note

- Depending on the VIDEO CD, [Press ENTER] in Step 3 may appear as [Press SELECT] in the operating instructions supplied with the disc. In this case, press \triangleright .

Tip

- To play without using the PBC function, press \lll / \ggg or the number buttons while the system is in stop

mode to select a track, then press \triangleright or \oplus . The system starts playback. You cannot play still pictures such as a menu. To return to PBC playback, press \blacksquare twice, then press \triangleright .

Resuming playback from the point where you stopped the disc

(Resume Play)



When you stop the disc, the system remembers the point where you pressed \blacksquare and “RESUME” appears in the front panel display. As long as you do not remove the disc, Resume Play will work even if the system is set to standby mode by pressing \mathbb{P} .

- 1 While playing a disc, press \blacksquare to stop playback.**

“RESUME” appears in the front panel display.

- 2 Press \triangleright .**

The system starts playback from the point where you stopped the disc in Step 1.

Note

- Depending on where you stop the disc, the system may not resume playback from exactly the same point.
- The point where you stopped playing may be cleared when:
 - you eject the disc.
 - the system enters standby mode (DATA CD/ DATA DVD only).
 - you change or reset the settings on the Setup Display.
 - you change the parental control level.
 - you change the function by pressing FUNCTION +/-.
 - you disconnect the AC power cord (mains lead).
- For a DVD-VR, VIDEO CD, Super Audio CD, CD, DATA CD, or DATA DVD, the system remembers the resume playback point for the current disc.
- Resume Play does not work during Program Play and Shuffle Play.
- This function may not work properly with some discs.

Tip

- To play from the beginning of the disc, press **■** twice, then press **▷**.

To enjoy a disc that you played before with resume playback (Multi-disc Resume)

DVD-V **VIDEO CD**

This system recalls the point where you stopped the disc the last time it was played and resumes playback from that point the next time you insert the same disc. When the resume playback memory is full, the resume playback point for the earliest disc is deleted.

To activate this function, set [MULTI-DISC RESUME] in [SYSTEM SETUP] to [ON]. For details, see “[MULTI-DISC RESUME] (DVD VIDEO/VIDEO CD only)” (page 50).

Note

- This system stores the resume points in memory for up to 10 discs.

Tip

- To play from the beginning of the disc, press **■** twice, then press **▷**.

Using Play Mode

Creating your own program

(Program Play)

VIDEO CD **CD**

You can play the contents of a disc in the order you want by arranging the order of the tracks on the disc to create your own program. You can program up to 99 tracks.

1 Press **⏏** **DISPLAY**.

The Control Menu display appears on the TV screen.

2 Press **↑/↓** to select **PROGRAM**, then press **+**.

The options for [PROGRAM] appear.

3 Press **↑/↓** to select [SET →], then press **+**.

Total time of the programmed tracks

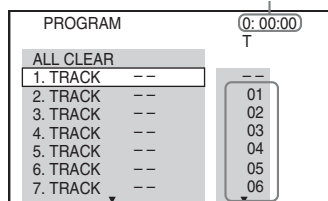

Tracks recorded on a disc

4 Press **→**.

The cursor moves to the track row [T] (in this case, [01]).

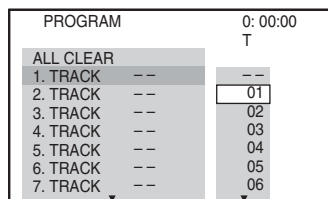

5 Select the track you want to program.

For example, select track [02].

Press **↑/↓** to select [02] under [T], then press **+**.

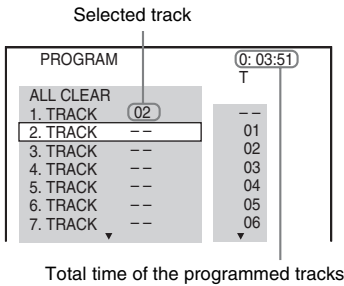

6 To program other tracks, repeat Steps 4 to 5.

The programmed tracks are displayed in the selected order.

7 Press \blacktriangleright to start Program Play.

Program Play starts.

When the program ends, you can restart the same program again by pressing \blacktriangleright .

To return to normal play

Press CLEAR while the display for the program setting is not displayed on the TV screen, or select [OFF] in Step 3. To play the same program again, select [ON] in Step 3 and press \oplus .

To turn off the Control Menu display

Press \square DISPLAY repeatedly until the Control Menu display is turned off.

To change or cancel a program

1 Follow Steps 1 to 3 of “Creating your own program.”

2 Press \uparrow/\downarrow to select the program number of the track you want to change or cancel.

If you want to delete the track from the program, press CLEAR.

3 Follow Step 5 for new programming.

To cancel a program, select [--] under [T], then press \oplus .

To cancel all of the tracks in the programmed order

1 Follow Steps 1 to 3 of “Creating your own program.”

2 Press \uparrow and select [ALL CLEAR].

3 Press \oplus .

Note

- When you press CLEAR to return to normal play, Shuffle Play and Repeat Play are also canceled.

Playing in random order

(Shuffle Play)

VIDEO CD Super Audio CD CD DATA-CD DATA DVD

You can play the contents on a disc in random order. Subsequent Shuffle Play may produce a different playing order.

Note

- The same song may be played repeatedly when you are playing MP3 files.

1 Press \square DISPLAY during playback.

The Control Menu display appears on the TV screen.

2 Press \uparrow/\downarrow to select \square [SHUFFLE], then press \oplus .

The options for [SHUFFLE] appear.

3 Press \uparrow/\downarrow to select the item to be shuffled.

■ VIDEO CD/Super Audio CD/CD

- [OFF]: Off.
- [TRACK]: You can shuffle tracks on the disc.

■ During Program Play

- [OFF]: Off.
- [ON]: You can shuffle tracks selected in Program Play.

■ DATA CD (except for video files)/DATA DVD (except for video files)

- [OFF]: Off.
- [ON (MUSIC)]: You can shuffle MP3 files in the folder on the current disc. When no folder is selected, the first folder will play in random order.

- 4** Press **+**.
Shuffle Play starts.

To return to normal play

Press CLEAR, or select [OFF] in Step 3.

To turn off the Control Menu display

Press **DISP** repeatedly until the Control Menu display is turned off.

Note

- You cannot use Shuffle Play with a VIDEO CD or Super VCD with PBC playback.
- When you press CLEAR to return to normal play, Program Play and Repeat Play are also canceled.

Playing repeatedly

(Repeat Play)



You can play the contents on a disc repeatedly. You can use a combination of Shuffle Play or Program Play modes.

- 1** Press **DISP** during playback.
The Control Menu display appears on the TV screen.
- 2** Press **↑/↓** to select **[REPEAT]**, then press **+**.
The options for [REPEAT] appear.
- 3** Press **↑/↓** to select the item to be repeated.

■ DVD VIDEO/DVD-VR

- [OFF]: Off.
- [DISC]: You can repeat all of the titles on the disc.
- [TITLE]: You can repeat the current title on a disc.
- [CHAPTER]: You can repeat the current chapter on a disc.

■ VIDEO CD/Super Audio CD/CD

- [OFF]: Off.
- [DISC]: You can repeat all of the tracks on the disc.

- [TRACK]: You can repeat the current track.

■ DATA CD/DATA DVD

- [OFF]: Off.
- [DISC]: You can repeat all of the folders on the disc.
- [FOLDER]: You can repeat the current folder.
- [TRACK] (MP3 files only): You can repeat the current file.
- [FILE] (video files only): You can repeat the current file.

- 4** Press **+**.

The item is selected.

To return to normal play

Press CLEAR, or select [OFF] in Step 3.

To turn off the Control Menu display

Press **DISP** repeatedly until the Control Menu display is turned off.

Note

- You cannot use Repeat Play with a VIDEO CD or Super VCD with PBC playback.
- When the system is playing a DATA CD/DATA DVD which contains MP3 files and JPEG image files, and their playing time is not the same, the audio sound will not match the image.
- When you press CLEAR to return to normal play, Program Play and Shuffle Play are also canceled.

Searching/Selecting Disc Contents

Using the DVD's menu



DVD-V

A DVD is divided into many sections, which make up a picture or music feature. These sections are called "titles." When you play a DVD which contains several titles, you can select the title you want using DVD TOP MENU.

When you play a DVD that allows you to select items such as the language for the subtitles and the language for the sound, select these items using DVD MENU.

- 1 Press DVD TOP MENU or DVD MENU.**
The disc's menu appears on the TV screen. The contents of the menu vary depending on the disc.
- 2 Press ←/↑/↓/→ or the number buttons to select the item you want to play or change.**
- 3 Press ⊕.**

To display the DVD's menu on the Control Menu display

- 1 Press  DISPLAY during playback.**
The Control Menu display appears on the TV screen.
- 2 Press ↑/↓ to select  [DISC MENU], then press ⊕.**
The options for [DISC MENU] appear.
- 3 Press ↑/↓ to select [MENU] or [TOP MENU].**
- 4 Press ⊕.**



To turn off the Control Menu display

Press  DISPLAY repeatedly until the Control Menu display is turned off.

Selecting an original title or edited title on a DVD-VR

DVD-VR

This function is only available for DVD-VRs with a playlist created.

- 1 Press  DISPLAY while the system is in stop mode.**
The Control Menu display appears on the TV screen.
- 2 Press ↑/↓ to select  [ORIGINAL/PLAY LIST], then press ⊕.**
The options for [ORIGINAL/PLAY LIST] appear.
- 3 Press ↑/↓ to select a setting.**
 - [PLAY LIST]: You can play the titles in the order of the existing playlist.
 - [ORIGINAL]: You can play the titles originally recorded.
- 4 Press ⊕.**

Searching for a title/chapter/track/scene, etc.

DVD-V

DVD-VR

VIDEO CD



Super Audio CD

CD

DATA-CD

DATA DVD

You can search a DVD VIDEO/DVD-VR by title or chapter, and you can search a VIDEO CD/Super Audio CD/CD/DATA CD/DATA DVD by track, index, or scene. For a DATA CD/DATA DVD, you can search by folder or file. As titles and tracks are assigned unique numbers on the disc, you can select the desired title or track by entering its number. Or, you can search for a scene using the time code.

- 1 Press  DISPLAY. (If [MEDIA] is set to [MUSIC/PHOTO], press  DISPLAY twice.)**
The Control Menu display appears on the TV screen.
- 2 Press ↑/↓ to select the search method.**
Example:  [CHAPTER]
[** (**)] is selected (** refers to a number).

The number in parentheses indicates the total number of titles, chapters, tracks, indexes, scenes, folders, or files.

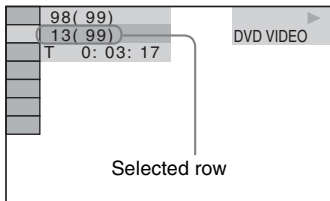

3 Press \oplus .

[** (**)] changes to [-- (**)].

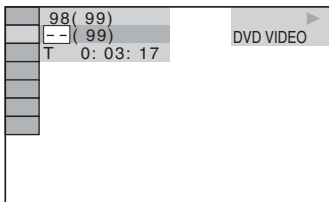

4 Press \uparrow/\downarrow or the number buttons to select the desired number of the title, chapter, track, index, scene, etc.

If you make a mistake, press CLEAR to cancel the number.

5 Press \oplus .

The system starts playback from the selected number.

Tip

- When the Control Menu display is turned off, you can search for a chapter (DVD VIDEO/DVD-R/DVD-RW), track (VIDEO CD/Super Audio CD/CD), or file (DATA CD/DATA DVD (video file)) by pressing the number buttons and \oplus .

To search for a scene using the time code

DVD-V DVD-VR

1 In Step 2, select ⌚ [TIME].

[T **:**:**] (playing time of the current title) is selected.

2 Press \oplus .

[T **:**:**] changes to [T --:--:--].

3 Input the time code using the number buttons.

For example, to find a scene at 2 hours, 10 minutes, and 20 seconds after the beginning: press 2, 1, 0, 2, 0 ([2:10:20]).

4 Press \oplus .

Note

- You cannot search for a scene on a DVD+RW using the time code.

Playing MP3 Files/JPEG Image Files

DATA-CD **DATA DVD**

You can play MP3 files or JPEG image files:

- which have the extension “.mp3” (MP3 file) or “.jpg”/“.jpeg” (JPEG image file).
- which conform to the DCF* image file format.
- * “Design rule for Camera File system”: Image standards for digital cameras regulated by Japan Electronics and Information Technology Industries Association (JEITA).

Note

- The system will play any files with the extension “.mp3,” “.jpg,” or “.jpeg” even if they are not in MP3 or JPEG format. Playing these files may generate a loud noise which could damage your speaker system.
- The system does not play back audio in MP3PRO format.
- The system can recognize up to 200 folders, and will not play any folders beyond the 200th. (Depending on the folder configuration, the number of folders that can be recognized by the system may decrease.)
- The system can recognize up to 150 MP3 files/JPEG image files in a folder.
- The system may take a longer time to play files when progressing to the following folder or jumping to other folders.
- The system may not play certain types of JPEG image files (ex. a JPEG image file that is less than 8 (width) × 8 (height)).

Selecting an MP3 file or folder

- 1 Press FUNCTION +/- repeatedly until “DVD” appears in the front panel display.**
- 2 Load a DATA CD or DATA DVD.**
After loading the disc, the list of folders appears on the TV screen.
- 3 Press  DISPLAY.**
The Control Menu display appears on the TV screen.

- 4 Press \uparrow/\downarrow to select  [MEDIA], then press \oplus .**

The options for [MEDIA] appear.

- 5 When [MUSIC] is selected, press DVD MENU. When other than [MUSIC] is selected, press \uparrow/\downarrow to select [MUSIC], then press \oplus .**

A list of folders that contain MP3 files appears.

The selected folder is highlighted in yellow.



- 6 Press \uparrow/\downarrow to select a folder.**

■ To play MP3 files in a folder

Press \triangleright to start playing the selected folder.

■ To select an MP3 file

Press \oplus .

The list of files contained in the folder appears.



Press \uparrow/\downarrow to select a file and press \oplus .

The system starts playing the selected file.

You can turn the file list off by pressing DVD MENU. Pressing DVD MENU again will display the folder list.

To go to the next or previous page

Press $\bullet\rightarrow / \leftarrow\bullet$.

To stop playback

Press \blacksquare .

To play the next or previous MP3 file

Press ►► to play the next MP3 file. Press ◀◀ twice to play the previous MP3 file.

When you press ◀◀ once, you can go to the beginning of the current MP3 file.

Note that you can select the next folder by continuing to press ►► after the last file on the current folder, but that you cannot return to the previous folder by pressing ◀◀. To return to the previous folder, select the folder from the folder list.

To return to the previous display

Press ↶ RETURN.

To turn on/off the display

Press DVD MENU.

To select the folder via the remote

During playback or pause, you can select the desired folder quickly by pressing ◻ +/-.

Other operations

See “Other operations” (page 28).

Selecting a JPEG image file or folder

1 Press FUNCTION +/- repeatedly until “DVD” appears in the front panel display.

2 Load a DATA CD or DATA DVD.

After loading the disc, the list of folders appears on the TV screen.

3 Press ◻ DISPLAY.

The Control Menu display appears on the TV screen.

4 Press ↑/↓ to select  [MEDIA], then press ⊕.

The options for [MEDIA] appear.

5 When [PHOTO] is selected, press DVD MENU. When other than [PHOTO] is selected, press ↑/↓ to select [PHOTO], then press ⊕.

A list of folders that contain JPEG files appears.

The selected folder is highlighted in yellow.

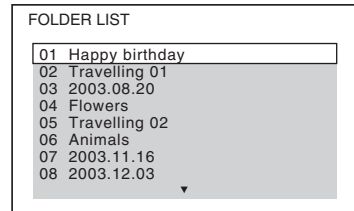

6 Press ↑/↓ to select a folder.

■ To go to the next or previous page

Press ●→/←●.

■ To play JPEG image files in a folder

Press ▷ to start playing the selected folder.

The JPEG images are played as a slide show. You can change the interval of the slide show (page 39), and add effects to the slide show (page 40).

■ To select a JPEG image file by displaying the image browser

Press PICTURE NAVI.

Previews of JPEG image files in the folder appear in 16 subscreens.

1	2	3	4
5	6	7	8
9	10	11	12
13	14	15	16

Press ←/↑/↓/→ to select the JPEG image file you want to view, then press ⊕.

To return to the previous screen, press ↶ RETURN.

To play the next or previous JPEG image file

Press →/← when the Control Menu display is not displayed. Note that you can select the next folder by continuing to press → after the last image on the current folder, but that you cannot return to the previous folder by pressing ←. To

return to the previous folder, select the folder from the folder list.

To rotate a JPEG image file

When a JPEG image file is displayed on the TV screen, you can rotate the JPEG image file in 90 degree increments.

Press **↑/↓** while viewing a JPEG image file.

Press **CLEAR** to return to normal view.

Note

- You cannot rotate the JPEG image file when you set [JPEG RESOLUTION] in [HDMI SETUP] to [(1920 × 1080i) HD 

To stop playback

Press **■**.

To turn on/off the display

Press **DVD MENU**.

To select the folder via the remote



During playback or pause, you can select the desired folder quickly by pressing **□ +/-**.

Other operations

See “Other operations” (page 28).

Playing a slide show with sound

You can play a slide show with sound by first placing both MP3 files and JPEG image files in the same folder on a DATA CD or DATA DVD.

- 1 Press **FUNCTION +/-** repeatedly until “DVD” appears in the front panel display.**
- 2 Load a DATA CD or DATA DVD.**
After loading the disc, the list of folders appears on the TV screen.
- 3 Press **☺ DISPLAY**.**
The Control Menu display appears on the TV screen.
- 4 Press **↑/↓** to select **  [MEDIA]**, then press **⊕**.**
The options for [MEDIA] appear.

- 5 When [MUSIC/PHOTO] is selected, press **DVD MENU**. When other than [MUSIC/PHOTO] is selected, press **↑/↓** to select [MUSIC/PHOTO], then press **⊕**.**

The list of folders appears.

- 6 Press **↑/↓** to select the desired folder and press **▷**.**

The system starts playing the selected folder.

You can turn the folder list on/off by pressing **DVD MENU** repeatedly.

Note

- If you play a large MP3 file and JPEG image file at the same time, the sound may skip. Sony recommends that you set the MP3 bit rate to 128 kbps or lower when creating the file. If the sound still skips, reduce the size of the JPEG image file.



Selecting the slide show duration of JPEG image files

- 1 Press **☺ DISPLAY**. (If [MEDIA] is set to [MUSIC/PHOTO], press **☺ DISPLAY** twice.)**
The Control Menu display appears on the TV screen.
- 2 Press **↑/↓** to select ** [INTERVAL]**, then press **⊕**.**
The options for [INTERVAL] appear.
- 3 Press **↑/↓** to select a setting.**
 - **[NORMAL]**: You can set to the standard duration.
 - **[FAST]**: You can set the duration shorter than [NORMAL].
 - **[SLOW 1]**: You can set the duration longer than [NORMAL].
 - **[SLOW 2]**: You can set the duration longer than [SLOW 1].
- 4 Press **⊕**.**



Note

- Some JPEG image files may take longer to display than the option you selected. Especially progressive JPEG image files or JPEG image files of 3,000,000 pixels or more.

Selecting an effect for JPEG image files in the slide show

- 1 Press  **DISPLAY**. (If [MEDIA] is set to [MUSIC/PHOTO], press  **DISPLAY** twice.)

The Control Menu display appears on the TV screen.

- 2 Press  to select  [EFFECT], then press .

The options for [EFFECT] appear.

- 3 Press  to select a setting.

- [MODE 1]: The JPEG image file sweeps in from top to bottom.
- [MODE 2]: The JPEG image file stretches out from left to right of the TV screen.
- [MODE 3]: The JPEG image file stretches out from the center of the TV screen.
- [MODE 4]: The JPEG image files randomly cycle through the effects.
- [MODE 5]: The next JPEG image file slides over the previous image.
- [OFF]: Off.

- 4 Press .

Note

- The [EFFECT] setting is not effective when you set [JPEG RESOLUTION] in [HDMI SETUP] to [(1920 × 1080i) HD ] or [(1920 × 1080i) HD] (page 48).

Selecting playback priority of the file type

You can select playback priority when mixed media (MP3 files, JPEG image files, or video files) are in the disc.

- 1 Press **FUNCTION +/-** repeatedly until “DVD” appears in the front panel display.

- 2 Load a **DATA CD** or **DATA DVD**.

After loading the disc, the list of folders appears on the TV screen.

- 3 Press  **DISPLAY**.

The Control Menu display appears on the TV screen.

- 4 Press  to select  [MEDIA], then press .

The options for [MEDIA] appear.

- 5 Press  to select a setting.

- [MUSIC/PHOTO]: You can play both JPEG image files and MP3 files in the same folder as a slide show.
- [MUSIC]: MP3 file playback has priority.
- [VIDEO]: Video file playback has priority.
- [PHOTO]: JPEG image file playback has priority. You can play JPEG image files as a slide show.



- 6 Press .

For details of the playback priority of file types under the [MEDIA] setting, see “Playback priority of file types” (page 93).

Displaying a list of MP3 files/JPEG image files

- 1 Press  **DISPLAY** during playback.

The Control Menu display appears on the TV screen.

- 2 Press  to select  [BROWSING], then press .

The options for [BROWSING] appear.

- 3 Press  to select the desired list, then press .

- [FOLDER LIST]: The list of folders appears. Follow Step 6 of “Selecting an MP3 file or folder” (page 37) or “Selecting a JPEG image file or folder” (page 38).
- [PICTURE LIST] (JPEG image files only): Previews of JPEG image files in the folder appear in 16 subscreens. Follow Step 6 of “Selecting a JPEG image file or folder” (page 38).

Enjoying Video Files

DATA-CD **DATA DVD**

About video files

You can play DivX video files and MPEG4 video files.

DivX[®] is a video file compression technology, developed by DivX, Inc. This product is an official DivX[®] Certified product.

You can play a DATA CD or DATA DVD that contains DivX[®] video files.

A DATA CD or DATA DVD that the system can play

The system only plays a DATA CD of format ISO 9660 Level 1/Level 2 or Joliet, and a DATA DVD of Universal Disk Format (UDF).

Refer to the operating instructions supplied with the disc drives and the recording software (not supplied) for details on the recording format.

About playback order of data on a DATA CD or DATA DVD

Note that the playback order may not be applicable, depending on the software used for creating the video file, or if there are more than 200 folders and 150 video files in each folder.

Note

- The system may not be able to play some DATA CDs/DATA DVDs created in the Packet Write format.

DivX video files that the system can play

The system can play data that is recorded in DivX format, and which has the extension “.avi” or “.divx.” The system will not play files with the extension “.avi” or “.divx” if they do not contain a DivX video.

Note

- The system may not play a DivX video file when the file has been combined from two or more DivX video files.
- The system cannot play a DivX video file of size more than 720 (width) × 576 (height) or 2GB.

- Depending on the DivX video file, sound may skip or not match the pictures on the TV screen.
- The system cannot play some DivX video files that are longer than 3 hours.
- Depending on the DivX video file, the picture may pause or be unclear, in which case it is recommended that you create the file at a lower bit rate. If the sound is still noisy, MP3 is the recommended audio format. Note, however, this system does not conform to WMA (Windows Media Audio) format for playing DivX files.
- Because of the compression technology used for DivX video files, it may take some time after you press \triangleright for the picture to appear.

MPEG4 video files that the system can play

The system can play data that is recorded in MP4 file format, and which has the extension “.mp4” or “.m4v.” The system will not play files with the extension “.mp4” or “.m4v” if they do not contain a MPEG4 video.

Note

- Compatibility with all MPEG4 video encoding/writing software, recording devices, and recording media cannot be guaranteed.

Selecting a folder

1 Press **FUNCTION +/-** repeatedly until “DVD” appears in the front panel display.

2 Load a DATA CD or DATA DVD.

After loading the disc, the list of folders appears on the TV screen.

3 Press \square **DISPLAY**.

The Control Menu display appears on the TV screen.

4 Press \uparrow/\downarrow to select  **[MEDIA]**, then press \oplus .

The options for [MEDIA] appear.

5 When [VIDEO] is selected, press **DVD MENU**. When other than [VIDEO] is selected, press \uparrow/\downarrow to select [VIDEO], then press \oplus .

A list of folders that contain video files appears.

The selected folder is highlighted in yellow.

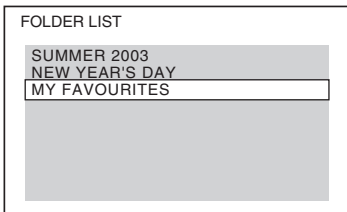

6 Press \uparrow/\downarrow to select the folder you want to play.

7 Press \triangleright .

The system starts playing the selected folder.

To select video files, see “Selecting a video file” (page 42).

To go to the next or previous page

Press $\bullet\rightarrow/\leftarrow\bullet$.

To stop playback

Press \blacksquare .

To turn on/off the display

Press DVD MENU.

To select the folder via the remote

During playback or pause, you can select the desired folder quickly by pressing \square +/-.

Other operations

See “Other operations” (page 28).

Selecting a video file

1 After Step 6 of “Selecting a folder,” press \oplus .

The list of files in the folder appears.

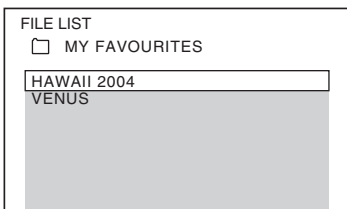

2 Press \uparrow/\downarrow to select a file and press \oplus .

The selected file starts playing.

To go to the next or previous page

Press $\bullet\rightarrow/\leftarrow\bullet$.

To return to the previous display

Press \curvearrowright RETURN.

To stop playback

Press \blacksquare .

To play the next or previous video file without turning on the above file list

You can select the next or previous video file in the same folder by pressing $\blacktriangleright/\blacktriangleleft$.

You can also select the first file of the next folder by pressing \blacktriangleright during playback of the last file of the current folder. Note that you cannot return to the previous folder by pressing \blacktriangleleft . To return to the previous folder, select it from the folder list.

Tip

- If the number of viewing times is preset, you can play a DivX video file as many times as the preset number. The following occurrences are counted:
 - when the system is turned off.
 - when another file is played.
 - when the disc tray is opened.

Displaying a list of video files

1 Press \square DISPLAY during playback.

The Control Menu display appears on the TV screen.

2 Press \uparrow/\downarrow to select \square [BROWSING], then press \oplus .

The options for [BROWSING] appear.

3 Press \uparrow/\downarrow to select [FOLDER LIST], then press \oplus .



The list of folders appears. Follow Step 6 of “Selecting a folder” (page 41).

Adjusting the Delay Between the Picture and Sound

[A/V SYNC]

DVD-V DVD-VR VIDEO CD DATA-CD DATA DVD

When the sound does not match the pictures on the TV screen, you can adjust the delay between the picture and sound.

- 1** Press  **DISPLAY**.
The Control Menu display appears on the TV screen.
- 2** Press \uparrow/\downarrow to select  [A/V SYNC], then press \oplus .
The options for [A/V SYNC] appear.
- 3** Press \uparrow/\downarrow to select a setting.
 - [OFF]: Off.
 - [ON]: You can adjust the delay between picture and sound.
- 4** Press \oplus .

Note

- Depending on the input stream, [A/V SYNC] may not be effective.



Restricting Playback of the Disc

[PARENTAL CONTROL]

DVD-V

The [PARENTAL CONTROL] function allows you to restrict playback of DVDs that have ratings. Scenes may be blocked or replaced with different scenes.

You can set the playback restriction by registering a password. When you set the [PARENTAL CONTROL] function to on, you need to enter the password to play restricted discs.

- 1** Press **FUNCTION +/-** repeatedly until “DVD” appears in the front panel display.
- 2** Press  **DISPLAY** while the system is in stop mode.
The Control Menu display appears on the TV screen.
- 3** Press \uparrow/\downarrow to select  [SETUP], then press \oplus .
The options for [SETUP] appear.
- 4** Press \uparrow/\downarrow to select [CUSTOM], then press \oplus .
The Setup Display appears.
- 5** Press \uparrow/\downarrow to select [SYSTEM SETUP], then press \oplus .
The options for [SYSTEM SETUP] appear.
- 6** Press \uparrow/\downarrow to select [PARENTAL CONTROL \rightarrow], then press \oplus .

■ If you have not entered a password

The display for registering a new password appears.

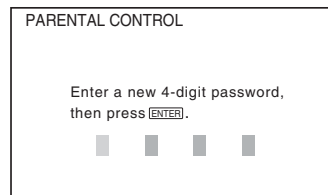

Enter a 4-digit password using the number buttons, then press \oplus .

The display for confirming the password appears.

■ When you have already registered a password

The display for entering the password appears.

7 Enter or re-enter your 4-digit password using the number buttons, then press \oplus .

The display for setting the playback limitation level appears.

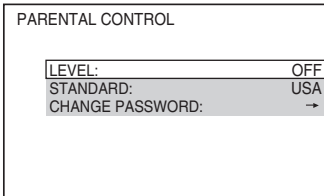

8 Press \uparrow/\downarrow to select [STANDARD], then press \oplus .

The selection items for [STANDARD] are displayed.

9 Press \uparrow/\downarrow to select a geographic area as the playback limitation level, then press \oplus .

The area is selected.

When you select [OTHERS \rightarrow], select and enter a standard code from “Parental Control Area Code List” (page 94) using the number buttons.

10 Press \uparrow/\downarrow to select [LEVEL], then press \oplus .

The selection items for [LEVEL] are displayed.

11 Press \uparrow/\downarrow to select the desired level, then press \oplus .

[PARENTAL CONTROL] setting is complete.

The lower the value, the stricter the limitation.

To turn off the [PARENTAL CONTROL] function

Set [LEVEL] to [OFF] in Step 11.

To play a disc for which [PARENTAL CONTROL] is set

1 Load the disc and press \triangleright .

The display for entering your password appears.

2 Enter your 4-digit password using the number buttons, then press \oplus .

The system starts playback.

Tip

- If you forget your password, remove the disc and repeat Steps 1 to 6 of “Restricting Playback of the Disc” (page 43). When you are asked to enter your password, enter “199703” using the number buttons, then press \oplus . The display will ask you to enter a new 4-digit password. After you enter a new 4-digit password, replace the disc in the unit and press \triangleright . When the display for entering your password appears, enter your new password.

Changing the password

1 Press FUNCTION +/- repeatedly until “DVD” appears in the front panel display.

2 Press \square DISPLAY while the system is in stop mode.

The Control Menu display appears on the TV screen.

3 Press \uparrow/\downarrow to select [SETUP], then press \oplus .

The options for [SETUP] appear.

4 Press \uparrow/\downarrow to select [CUSTOM], then press \oplus .

The Setup Display appears.

5 Press \uparrow/\downarrow to select [SYSTEM SETUP], then press \oplus .

The options for [SYSTEM SETUP] appear.

6 Press \uparrow/\downarrow to select [PARENTAL CONTROL \rightarrow], then press \oplus .

The display for entering the password appears.

- 7** Enter your 4-digit password using the number buttons, then press **+**.
- 8** Press **↑/↓** to select [CHANGE PASSWORD →], then press **+**.
- 9** Enter a new 4-digit password using the number buttons, then press **+**.
- 10** To confirm your password, re-enter it using the number buttons, then press **+**.

If you make a mistake entering your password

Press **←** before you press **+**, then input the correct number.

Changing the System Settings by Using the Setup Display

You can make various adjustments to items such as picture and sound. Displayed items vary depending on the area.

Note

- Playback settings stored in the disc take priority over the Setup Display settings and not all the functions described may work.

- 1** Press **FUNCTION +/-** repeatedly until “DVD” appears in the front panel display.
- 2** Press **DISPLAY** while the system is in stop mode.
The Control Menu display appears on the TV screen.
- 3** Press **↑/↓** to select **[SETUP]**, then press **+**.
The options for [SETUP] appear.
- 4** Press **↑/↓** to select **[CUSTOM]**, then press **+**.
The Setup Display appears.
- 5** Press **↑/↓** to select the setup item, then press **+**.
 - [LANGUAGE SETUP] (page 46)
 - [VIDEO SETUP] (page 46)
 - [HDMI SETUP] (page 47)
 - [AUDIO SETUP] (page 49)
 - [SYSTEM SETUP] (page 49)
 - [SPEAKER SETUP] (page 50)

Example: [VIDEO SETUP]

Selected item

VIDEO SETUP	
TV TYPE:	16:9
LINE:	VIDEO
PAUSE MODE:	AUTO

Setup items

6 Press \uparrow/\downarrow to select an item, then press



The options for the selected item appear.

Example: [TV TYPE]

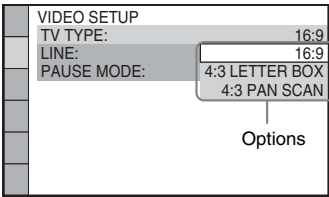

7 Press \uparrow/\downarrow to select a setting, then press



The setting is selected and setup is complete.

Example: [4:3 LETTER BOX]

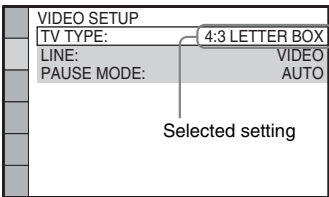

To reset all of the [SETUP] settings

To reset all of the [SETUP] settings, see “Returning the [SETUP] settings to the default” (page 78).

Setting the display or sound track language

[LANGUAGE SETUP]

Set various languages for the on-screen display or sound track.

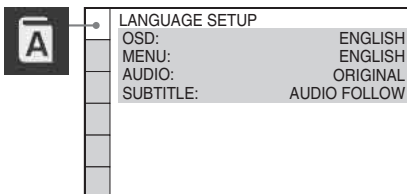

■ [OSD] (On-Screen Display)

You can switch the display language on the TV screen.

■ [MENU] (DVD VIDEO only)

You can switch the language for the disc's menu.

■ [AUDIO] (DVD VIDEO only)

You can switch the language of the sound track. When you select [ORIGINAL], the language given priority on the disc is selected.

■ [SUBTITLE] (DVD VIDEO only)

You can switch the language of the subtitles recorded on the DVD VIDEO. When you select [AUDIO FOLLOW], the language for the subtitles changes according to the language you selected for the sound track.

Note

- When you select a language in [MENU], [AUDIO], or [SUBTITLE] that is not recorded on the DVD VIDEO, one of the recorded languages will be automatically selected (depending on the disc, the language may not be selected automatically).

Tip

- If you select [OTHERS \rightarrow] in [MENU], [AUDIO], and [SUBTITLE], select and enter a language code from “Language Code List” (page 94) using the number buttons.

Settings for the display

[VIDEO SETUP]

Select settings according to the TV to be connected.

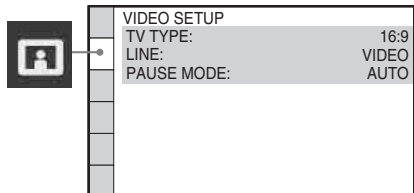

■ [TV TYPE]

You can select the aspect ratio of the connected TV.

[16:9]: Select this when you connect a wide-screen TV or a TV with a wide mode function.



[4:3 LETTER BOX]: Select this when you connect a 4:3 standard TV. The system displays a wide picture with bands on the upper and lower portions of the TV screen.



[4:3 PAN SCAN]: Select this when you connect a 4:3 standard TV. The system automatically displays a wide picture on the entire screen and cuts off the portions that do not fit.

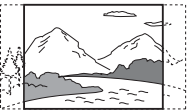

Note

- Depending on the DVD, [4:3 LETTER BOX] may be selected automatically instead of [4:3 PAN SCAN] or vice versa.

■ [LINE]

You can select the output method for video signals from the EURO AV \Rightarrow OUTPUT (TO TV) jack on the rear panel of the unit.

[VIDEO]: The system outputs video signals.

[RGB]: The system outputs RGB signals.

Note

- If your TV does not accept RGB signals, no picture appears on the TV screen even if you select [RGB]. Refer to the operating instructions supplied with your TV.
- You cannot select [RGB] while "HDMI" is lit. [RGB] automatically switches to [VIDEO] when you turn on any connected HDMI equipment.

■ [PAUSE MODE] (DVD VIDEO/DVD-R/DVD-RW only)

You can select the picture in pause mode.

[AUTO]: The picture, including subjects that move dynamically, is output with no jitter. This setting is for normal usage.

[FRAME]: The picture, including subjects that do not move dynamically, is output in high resolution.

Settings for HDMI

[HDMI SETUP]

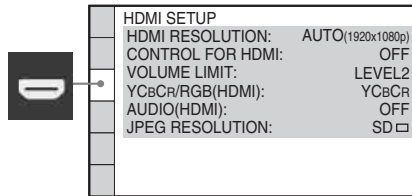

■ [HDMI RESOLUTION]

You can select the type of video signal that is output from the HDMI OUT jack. For details, see "To select the type of video signal output from the HDMI OUT jack" (page 22).

[AUTO (1920 × 1080p)]: The system outputs the optimal video signal for the connected TV.

[1920 × 1080i]: The system outputs 1920 × 1080i* video signals.

[1280 × 720p]: The system outputs 1280 × 720p* video signals.

[720 × 480p]**: The system outputs 720 × 480p* video signals.

* i: interlace, p: progressive

** Depending on the area, [720 × 480/576p] may appear.

■ [CONTROL FOR HDMI]

You can set the [CONTROL FOR HDMI] function to on/off. This function is available when you connect the system and TV with an HDMI cable. For details, see "Using the Control

for HDMI Function for “BRAVIA” Sync” (page 55).

[OFF]: Off.

[ON]: On. You can operate mutually between components that are connected with an HDMI cable.

■ [VOLUME LIMIT]

If you change the output method of the TV to the system speakers via the TV menu (or by pressing THEATRE), the System Audio Control (page 56) is activated and loud sound may be output depending on the volume level of the system. You can prevent this by limiting the maximum level of the volume.

[LEVEL3]: Maximum volume level is set to 10.

[LEVEL2]: Maximum volume level is set to 15.

[LEVEL1]: Maximum volume level is set to 20.

[OFF]: Off.

Note

- This function is available only when [CONTROL FOR HDMI] is set to [ON].

■ [YCbCr/RGB (HDMI)]

You can select the type of HDMI signal output from the HDMI OUT jack.

[YCbCr]: The system outputs YCbCr signals.

[RGB]: The system outputs RGB signals.

Note

- If the playback picture becomes distorted, set [YCbCr] to [RGB].
- If the HDMI OUT jack is connected to a component with a DVI jack, [RGB] signals will be automatically output even when you select [YCbCr].

■ [AUDIO (HDMI)]

You can select the audio output status from the HDMI OUT jack.

[OFF]: The system does not output sound from the HDMI OUT jack.

[ON]: The system outputs audio signals by converting Dolby Digital, DTS, or 96 kHz/24-bit PCM signals to 48 kHz/16-bit PCM.

Note

- When you connect the unit and TV with an HDMI cable and [ON] is selected, [AUDIO DRC], [A/V SYNC], DYNAMIC BASS, “DEC. MODE,” and sound mode are not applied to the sound that is output from the TV.
- When you set the function to other than “DVD” or “USB,” the system does not output the sound from the HDMI OUT jack even if you set [AUDIO (HDMI)] to [ON].

■ [JPEG RESOLUTION]

You can select the resolution of JPEG image files output from the HDMI OUT jack.

[SD]: The system outputs standard resolution with a black frame.

[HD]: The system outputs HD resolution with a black frame.

[HD]: The system outputs the HD resolution without a black frame.

[(1920 × 1080i) HD]: The system outputs full size HD resolution with a black frame.

[(1920 × 1080i) HD]: The system outputs full size HD resolution without a black frame.

Note

- [JPEG RESOLUTION] is effective only when you set [TV TYPE] in [VIDEO SETUP] to [16:9], and you set [HDMI RESOLUTION] in [HDMI SETUP] to other than [720 × 480p] or [720 × 480/576p].
- You can select [(1920 × 1080i) HD] or [(1920 × 1080i) HD] only when you set [HDMI RESOLUTION] in [HDMI SETUP] to [1920 × 1080i].
- The HDMI signal will stop momentarily when:
 - the system is loading or unloading a DATA CD or DATA DVD.
 - you connect or remove a USB device.

Settings for the audio

[AUDIO SETUP]

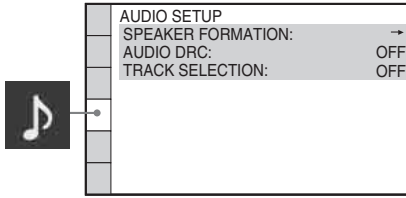

■ [SPEAKER FORMATION]

You can select the position of the speakers for better surround sound. For details, see “Getting Optimal Surround Sound for a Room” (page 71).

■ [AUDIO DRC] (DVD VIDEO only)

You can compress the dynamic range of the sound track. [AUDIO DRC] is useful for watching movies at low volume late at night.

[OFF]: No compression of dynamic range.

[STANDARD]: The system reproduces the sound track with the kind of dynamic range that the recording engineer intended.

[MAX]: The system compresses dynamic range fully.

Note

- [AUDIO DRC] works only for Dolby Digital.

■ [TRACK SELECTION] (DVD VIDEO only)

You can give the sound track which contains the highest number of channels priority when you play a DVD VIDEO on which multiple audio formats (PCM, DTS, Dolby Digital, or MPEG audio) are recorded.

[OFF]: Off.

[AUTO]: The system selects the sound track automatically according to the priority.

Note

- When you set the item to [AUTO], the language may change. The [TRACK SELECTION] setting has higher priority than the [AUDIO] settings in

[LANGUAGE SETUP] (page 46). (Depending on the disc, this function may not work.)

- If PCM, DTS, Dolby Digital sound, and MPEG audio have the same number of channels, the system selects PCM, DTS, Dolby Digital sound, and MPEG audio in this order.

Other Settings

[SYSTEM SETUP]

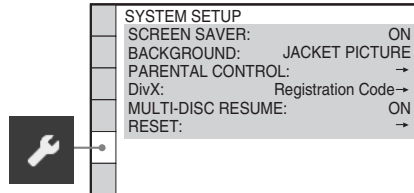

■ [SCREEN SAVER]

You can reduce the damage to the display device (ghosting). Press any button (e.g., \triangleright) to cancel the screen saver.

[ON]: The screen saver image appears if you do not operate the system for about 15 minutes.

[OFF]: Off.

■ [BACKGROUND]

You can select the background color or picture on the TV screen.

[JACKET PICTURE]: The jacket picture (still picture) appears, but only when the jacket picture is already recorded on the disc (CD-EXTRA, etc.). If the disc does not contain a jacket picture, the [GRAPHICS] picture appears.

[GRAPHICS]: A preset picture stored in the system appears.

[BLUE]: The background is blue.

[BLACK]: The background is black.

■ [PARENTAL CONTROL]

You can set the playback restrictions. For details, see “Restricting Playback of the Disc” (page 43).

■ [DivX]

You can display the registration code for this system.

For more information, go to <http://www.divx.com> on the Internet.

■ [MULTI-DISC RESUME] (DVD VIDEO/VIDEO CD only)

You can set the [MULTI-DISC RESUME] function to on/off.

[ON]: The system stores the resume points in memory for up to 10 discs.

[OFF]: The system does not store the resume points in memory. Playback restarts at the resume point only for the current disc in the unit.

■ [RESET]

You can return the [SET UP] settings other than [PARENTAL CONTROL] to the default settings. For details, see “Returning the [SETUP] settings to the default” (page 78).

Settings for the speakers

[SPEAKER SETUP]

To obtain the best possible surround sound, set connection of the speakers and their distance from your listening position. Then use the test tone to adjust the level and the balance of the speakers to the same level.

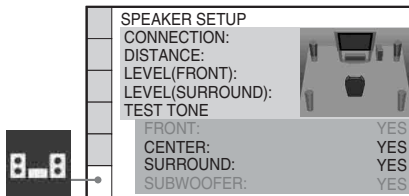

■ [CONNECTION]

If you do not connect center or surround speakers, set the parameters for [CENTER] and [SURROUND]. Since the front speaker and subwoofer settings are fixed, you cannot change them.

[FRONT]

[YES]

[CENTER]

[YES]: Normally select this.

[NONE]: Select this if no center speaker is used.

[SURROUND]

[YES]: Normally select this.

[NONE]: Select this if no surround speakers are used.

[SUBWOOFER]

[YES]

Note

- When you change the [CONNECTION] setting, the [STANDARD] of [SPEAKER FORMATION] setting remains the same, but the other settings of [SPEAKER FORMATION] return to [STANDARD].

■ [DISTANCE]

When you move the front speakers, center speaker, and surround speakers, be sure to set the parameters of the distance (A) from the listening position to the speakers.

You can set the parameters from 1.0 to 7.0 meters¹⁾ (3 to 23 ft) for the front speakers, from 0.0 to 7.0 meters²⁾ (0 to 23 ft) for the center speaker and surround speakers.

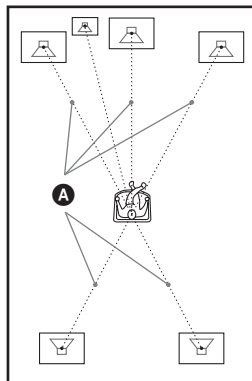

[FRONT] 3.0 m/10 ft³⁾: Set the front speaker distance.

[CENTER] 3.0 m/10 ft³⁴⁾: Set the center speaker distance (up to 1.6 meters (5 ft) closer to the front speakers).

[SURROUND] 3.0 m/10 ft³⁾⁵⁾: Set the surround speaker distance (up to 5.0 meters (16 ft) closer to the front speakers).

¹⁾0.9 to 6.9 meters for North American models.

²⁾0.0 to 6.9 meters for North American models.

³⁾When you perform the Quick Setup (page 21), the default settings are changed.

⁴⁾This item appears when you set [CENTER] to [YES] in the [CONNECTION] setting.

⁵⁾This item appears when you set [SURROUND] to [YES] in the [CONNECTION] setting.

Note

- If all front and surround speakers are not placed at an equal distance from your listening position, set the distance according to the closest speaker.
- Do not place the surround speakers farther away from your listening position than the front speakers.
- Depending on the input stream, the [DISTANCE] setting may not be effective.

■ [LEVEL (FRONT)]

You can adjust the sound level of the front speakers, center speaker, and subwoofer. You can set the parameters from -6.0 dB to 0 dB for [L/R], and from -6.0 dB to $+6.0$ dB for [CENTER] and [SUBWOOFER]. Be sure to set [TEST TONE] to [ON] for easy adjustment.

[L/R] 0.0 dB: Set the front speaker level.

[CENTER] 0.0 dB*: Set the center speaker level.

[SUBWOOFER] +2.0 dB: Set the subwoofer level.

* This item appears when you set [CENTER] to [YES] in the [CONNECTION] setting.

■ [LEVEL (SURROUND)]

You can adjust the sound level of the surround speakers. You can set the parameter from -6.0 dB to $+6.0$ dB. Be sure to set [TEST TONE] to [ON] for easy adjustment.

[L/R] 0.0 dB*: Set the surround speaker level.

* This item appears when you set [SURROUND] to [YES] in the [CONNECTION] setting.

■ [TEST TONE]

The speakers will emit a test tone to adjust [LEVEL (FRONT)] and [LEVEL (SURROUND)].

[OFF]: The test tone is not emitted from the speakers.

[ON]: The test tone is emitted from each speaker in sequence while adjusting the level. When you select one of the [SPEAKER SETUP] items, the test tone is emitted from each speaker in sequence.

Adjust the sound level as follows.

- 1 Set the [TEST TONE] to [ON].
- 2 Press $\leftarrow/\uparrow/\downarrow/\rightarrow$ repeatedly to select the desired speaker and the level.
- 3 Press \oplus .
- 4 Repeat Steps 1 to 3.
- 5 Press $\leftarrow/\uparrow/\downarrow/\rightarrow$ repeatedly to set [TEST TONE] to [OFF] after adjusting the speaker level.

Tip

- To adjust the volume of all the speakers at one time, turn the VOLUME control on the unit, or press VOLUME +/- on the remote.
- To return to the default setting when changing a setting, select the item, then press CLEAR. Note that only the [CONNECTION] setting does not return to the default setting.

Presetting Radio Stations

You can preset 20 FM stations. Before tuning, make sure to turn down the volume to minimum.

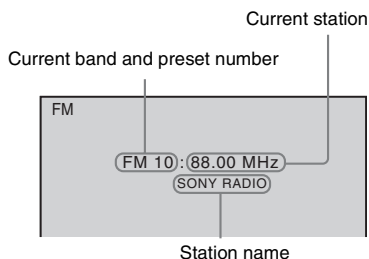

1 Press **FUNCTION +/-** repeatedly until **"TUNER FM"** appears in the front panel display.

2 Press and hold **TUNING +/-** until the auto scanning starts.

Scanning stops when the system tunes in a station. **"TUNED"** and **"ST"** (stereo program) appear in the front panel display.

3 Press **SYSTEM MENU**.

4 Press **↑/↓** repeatedly until **"MEMORY"** appears in the front panel display.

5 Press **⊕** or **→**.

A preset number appears in the front panel display.

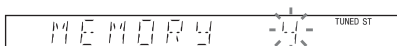

6 Press **↑/↓** to select the preset number you want.

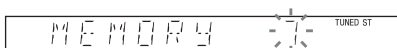

Tip

- You can select the preset number directly by pressing the number buttons.

7 Press **⊕**.

"COMPLETE" appears in the front panel display, and the station is stored.

8 Repeat Steps 2 to 7 to store other stations.

9 Press **SYSTEM MENU**.

The system menu turns off.

To change the preset number

Select the desired preset number by pressing **PRESET +/-** (page 53), then perform the procedure from Step 3.

Listening to the Radio

Preset radio stations in the system's memory first (see "Presetting Radio Stations" (page 52)).

1 Press FUNCTION +/- repeatedly until "TUNER FM" appears in the front panel display.

The last received station is tuned in.

2 Press PRESET +/- repeatedly to select the preset station.

Each time you press the button, the system tunes in one preset station.

Tip

- You can select the preset station number directly by pressing the number buttons.

3 Adjust the volume by pressing VOLUME +/-.

To turn off the radio

Press I/O.

To listen to non-preset radio stations

Use manual or automatic tuning in Step 2. For manual tuning, press TUNING +/- repeatedly.

For automatic tuning, press and hold TUNING +/- . The automatic tuning stops automatically when the system receives the radio station. To stop the automatic tuning manually, press TUNING +/- or ■.

To listen to radio stations when you know the frequencies

Press D.TUNING in Step 2, press the number buttons to select the frequencies, then press ⊕.

Tip

- To improve reception, reorient the connected antennas (aerials).

If an FM program is noisy

If an FM program is noisy, you can select monaural reception. There will be no stereo effect, but reception will improve.

1 Press SYSTEM MENU.

2 Press ↑/↓ repeatedly until "FM MODE" appears in the front panel display.



3 Press ⊕ or →.

4 Press ↑/↓ to select "MONO."

- "STEREO": Stereo reception.
- "MONO": Monaural reception.

5 Press ⊕.

The setting is made.

6 Press SYSTEM MENU.

The system menu turns off.

Naming preset stations

You can enter a name for preset stations. These names (for example, "ABC") appear in the front panel display when a station is selected.

Only one name can be entered for each preset station.

Note

- You cannot enter a name for preset stations of the Radio Data System (RDS) (page 54).

1 Press FUNCTION +/- repeatedly until "TUNER FM" appears in the front panel display.

The last received station is tuned in.

2 Press PRESET +/- repeatedly to select the preset station you want to create an index name for.

3 Press SYSTEM MENU.

4 Press ↑/↓ repeatedly until "NAME IN" appears in the front panel display.

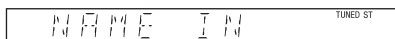

5 Press ⊕ or →.

6 Create a name by using ←/↑/↓/→.

Press ↑/↓ to select a character, then press → to move the cursor to the next position.

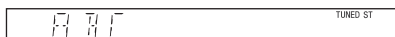

You can input letters, numbers, and other symbols for a radio station.

If you make a mistake

Press ←/→ repeatedly until the character to be changed flashes, then press ↑/↓ to select the desired character.

To erase the character, press ←/→ repeatedly until the character to be erased flashes, then press CLEAR.

7 Press ⊕.

“COMPLETE” appears in the front panel display, and the station name is stored.

8 Press SYSTEM MENU.

The system menu turns off.

Viewing the station name or frequency in the front panel display

When the system is set to “TUNER FM,” you can check the frequency using the front panel display.

Press DISPLAY.

Each time you press DISPLAY, the display changes:

① → ② → → ① →

When the station name is set

① Station name

Ex. “SONY RADIO”

② Frequency

Ex. “FM1 87.50”

③ The “FM MODE” setting

Ex. “STEREO”

When the station name is not set

① Frequency

Ex. “FM1 87.50”

② The “FM MODE” setting

Ex. “STEREO”

Using the Radio Data System (RDS)

What is the Radio Data System?

The Radio Data System (RDS) is a broadcasting service that allows radio stations to send additional information along with the regular program signal. This tuner offers convenient RDS features, such as station name display. RDS is available only for FM stations.*

Note

- RDS may not work properly if the station you are tuned to is not transmitting the RDS signal properly, or if the signal strength is weak.
- * Not all FM stations provide RDS service, nor do they provide the same type of services. If you are not familiar with the RDS system, check with your local radio stations for details on RDS services in your area.

Receiving RDS broadcasts

Simply select a station from the FM band.

When you tune in a station that provides RDS services, the station name* appears in the front panel display.

- * If an RDS broadcast is not received, the station name may not appear in the front panel display.

Control for HDMI/External Audio Device

Using the Control for HDMI Function for “BRAVIA” Sync

This function is available on TVs with the “BRAVIA” Sync function only.

By connecting Sony components that are compatible with the Control for HDMI function with an HDMI cable, operation is simplified as below:

- Theatre Mode (page 56)
- One-Touch Play (page 56)
- System Power Off (page 56)
- System Audio Control (page 56)
- Volume Limit (page 57)
- Language Follow (page 57)

Control for HDMI is a mutual control function standard used by CEC (Consumer Electronics Control) for HDMI (High-Definition Multimedia Interface).

The Control for HDMI function will not work in the following cases:

- When you connect this system to a component which is not compatible with the Control for HDMI function.

- A component does not have an HDMI jack.

There are convenient buttons on the system’s remote for operating the TV, such as THEATRE, ONE-TOUCH PLAY, TV I/⏻. For details, see “Controlling the TV with the Supplied Remote” (page 72) and refer to the operating instructions of the TV.

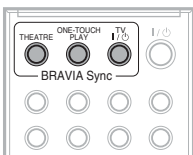

Note

- Depending on the connected component, the Control for HDMI function may not work. Refer to the operating instructions supplied with the component.
- The Control for HDMI function may not work if you connect a component other than a Sony component, even if the component is compatible with the Control for HDMI function.

Preparing the Control for HDMI function

(Control for HDMI - Easy Setting)

The system is compatible with the Control for HDMI - Easy Setting function. If the TV is compatible with the Control for HDMI - Easy Setting function, you can set the system’s [CONTROL FOR HDMI] function automatically by setting the TV. For details, refer to the operating instructions of the TV.

If the TV is not compatible with the Control for HDMI - Easy Setting function, set the Control for HDMI function of the system and TV manually.

- 1 Make sure that the system and the TV are connected with an HDMI cable.**
- 2 Turn on the TV and press I/⏻ to turn on the system.**
- 3 Switch the input selector on your TV so that the signal from the system through the HDMI input appears on the TV screen.**
- 4 Set the Control for HDMI function of the system and TV.**

For details of the system settings, see the following Steps. For details of the setting of the TV, refer to the operating instructions of the TV (depending on the TV, the default setting of the Control for HDMI function may be set to off).

To set the [CONTROL FOR HDMI] function to on/off

- 1 Press FUNCTION +/- repeatedly until “DVD” appears in the front panel display.**

2 Press DISPLAY while the system is in stop mode.

The Control Menu display appears on the TV screen.

3 Press to select [SETUP], then press .

The options for [SETUP] appear.

4 Press to select [CUSTOM], then press .

The Setup Display appears.

5 Press to select [HDMI SETUP], then press .

The options for [HDMI SETUP] appear.

6 Press to select [CONTROL FOR HDMI], then press .

7 Press to select the setting, then press .

- [OFF]: Off.
- [ON]: On.

Using the Theatre Mode

(Theatre Mode)

If your TV is compatible with the Theatre Mode, you can enjoy optimal image and sound quality suited for movies, and sound is output from the system's speakers automatically by pressing THEATRE.

Watching a DVD by a single button press

(One-Touch Play)

By only pressing ONE-TOUCH PLAY, the TV turns on, the TV is set for DVD input mode, and the system starts playing a disc automatically.

Note

- One-Touch Play does not work when you press .

The system and TV work as follows (e.g.):

This system	TV
Turns on. (If not already turned on.)	Turns on. (If not already turned on.)
↓	↓
Switches to "DVD" function.	Switches to HDMI input.
↓	↓
Starts playing the disc and outputs the sound.	Minimizes sound level. (System Audio Control)

Turning the system off in sync with the TV

(System Power Off)

When you turn the TV off by using the POWER button on the TV's remote or TV  on the system's remote, the system turns off automatically.

Note

- Before using the System Power Off function, set the function for TV power. For details, refer to the operating instructions of the TV.
- Depending on the status of the system (ex. while using other than "DVD," "TV," or "USB" functions, or playing a CD), the system may not turn off automatically.

Enjoying TV sound from the speakers by this system

(System Audio Control)

You can enjoy TV sound via this system easily. To use this function, connect the system and the TV with a SCART (EURO AV) cable and an HDMI cable (page 16).

Depending on the TV, when you set the system to the "TV" function, the System Audio Control function is activated. TV sound is output from the system speakers, and the volume of the TV speakers is minimized automatically.

You can use the System Audio Control function as follows:

- While you are watching the TV and the function of the system is switched to "TV," TV

sound is output from the system speakers automatically.

- While you are watching the TV and the function of the system is switched to “DVD” or “USB,” sound of the selected system function is output from the system speakers; TV sound is not output via the TV speakers.
- You can control the system’s volume by the remote of the TV.
- If you turn the system off or set the function of the system to other than “TV,” “DVD,” or “USB,” TV sound is output from the TV speakers.

You can also operate the System Audio Control function via the TV menu. For details, refer to the operating instructions of the TV.

Note

- While the TV is in PAP (picture and picture) mode, the System Audio Control function will not work. When the TV exits PAP mode, the output method of the TV returns to the one before PAP mode.
- While transferring songs on an audio CD onto a USB device, the System Audio Control function will not work.

Setting the Maximum Volume Level of the System

(Volume Limit)

If you change the output method of the TV to the system speakers via the TV menu (or by pressing THEATRE), loud sound may be output depending on the volume level of the system. You can prevent this by limiting the maximum level of the volume. For details, see “[VOLUME LIMIT]” (page 48).

Changing the language for the on-screen display of the TV

(Language Follow)

When you change the language for the on-screen display of the TV, the system’s on-screen display language is also changed. However, when the system’s on-screen display is displayed, this function does not work.

Playing Back Files of a USB Device

You can play audio files (MP3/WMA/AAC files)/JPEG image files/video files (DivX/MPEG4 video files) stored in a USB device such as the digital music player or USB storage media (not supplied) by connecting the USB device to the unit.

For a list of USB devices that can be connected to the unit, see “Playable USB Devices” (supplement).

The audio formats that can be played back by the system are MP3/WMA/AAC files* only.

* Files with copyright protection (Digital Rights Management) cannot be played by the system.

Note

- The system cannot play WMA/AAC files on a DATA CD/DATA DVD.

About playable USB devices

- Do not use USB devices other than these USB devices. Operation of models not listed here is not guaranteed.
- Operation may not always be ensured even when using these USB devices.
- Some of these USB devices may not be available for purchase in certain areas.
- During playback or transferring of files, there is a small possibility that these operations may be stopped due to excess static buildup in the system or the USB device. In this case, remove the USB device and reconnect it, then retry the operation from the beginning.
- When formatting a USB device, be sure to do so using the device itself, or dedicated formatting software for the device. Otherwise, you may be unable to properly transfer from the USB device to this system.
- Some files supported by the Walkman® are not supported by this system.
- When connecting a Walkman® to the system, be sure to connect after the display “Creating Library” or “Creating Database” on the Walkman® has disappeared.
- When transferring music to a Walkman® using “Media Manager for WALKMAN,” be sure to transfer in MP3 format. For details, refer to the

operating manual supplied with the Walkman®.

Connecting the USB device

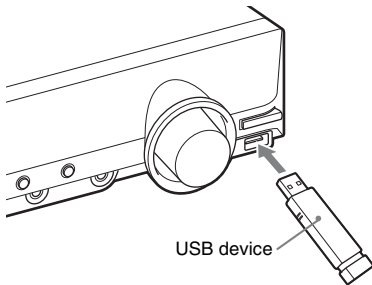

- 1 Press FUNCTION +/- repeatedly until "USB" appears in the front panel display.**
- 2 Connect a USB device (digital music player or USB storage media) to the USB port.**

When you connect the USB device, "READING" appears in the front panel display until the system reads all data of the USB device.

Note

- Do not forcibly insert the USB device, as this may cause the device to be damaged.
- Do not connect any devices or objects other than a USB device.
- It may take about 10 seconds before "READING" appears in the front panel display depending on the type of the USB device.

To remove the USB device

- 1 Press ■ to stop playback.**
- 2 Press I/O to turn off the system.**
- 3 Remove the USB device.**

Notes on the USB device

- The system can play back up to 200 folders, including albums (folders) that do not contain audio files and JPEG image files. When more than 200 folders are in the USB device, folders that are recognized by the system differ depending on the folder configuration.

- The system can play back the following files.

File	Extension of the file
MP3 file	“.mp3”
WMA file	“.wma”
AAC file	“.m4a”
JPEG image file	“.jpg” or “.jpeg”
DivX video file	“.avi” or “.divx”
MPEG4 video file	“.mp4” or “.m4v”

The system will play back any data with the extension above, even if it is not MP3/WMA/AAC/JPEG/DivX/MPEG4 format. Playing this data may generate a loud noise which could damage your speaker system.

- The following USB devices/situations can increase the time it takes to start playback:
 - a USB device recorded with a complicated tree structure.
 - when the audio files, JPEG image files, or video files in another folder have just been played back.
- Some USB devices cannot be played back on the system depending on the file format.
- The system can play back to a depth of 8 folders only.
- The system may not be able to play an audio file, JPEG image file, or video file depending on the file type.
- When the USB device is inserted, the system reads all the files on the USB device. If there are many folders or files on the USB device, it may take a long time to finish reading the USB device.
- Do not connect the system and the USB device through a USB hub.
- With some connected USB devices, after an operation is performed, there may be a delay before it is performed by this system.
- This system does not necessarily support all the functions provided in a connected USB device.
- Files recorded by a device such as a computer may not be played back in the order in which they were recorded.
- The playback order for the system may differ from the playback order of the connected USB device.

- Always turn off the system before removing the USB device. Removing the USB device while the system is on may corrupt the data on the USB device.
- Do not save other types of files or unnecessary folders on a USB device that has audio files, JPEG image files, or video files.
- Folders that have no audio files, JPEG image files, or video files are skipped.
- Compatibility with all MP3/WMA/AAC encoding/writing software, recording devices, and recording media cannot be guaranteed. An incompatible USB device may produce noise or interrupted audio or may not play at all.
- Compatibility with all MPEG4 video encoding/writing software, recording devices, and recording media cannot be guaranteed.
- Before using the USB device, make sure that no virus-ridden files are on the USB device.

Selecting an audio file or folder

- 1** Press **FUNCTION +/-** repeatedly until **"USB"** appears in the front panel display.
- 2** Connect a **USB device** to the **↔ (USB)** port.
After reading all data of the USB device, the list of folders appears on the TV screen.
- 3** Press **DISPLAY**.
The Control Menu display appears on the TV screen.
- 4** Press **↑/↓** to select **[MEDIA]**, then press **+**.
The options for [MEDIA] appear.
- 5** When **[MUSIC]** is selected, press **DVD MENU**. When other than **[MUSIC]** is selected, press **↑/↓** to select **[MUSIC]**, then press **+**.
A list of folders that contain audio files appears.
The selected folder is highlighted in yellow.

FOLDER LIST

```

01 Let's Talk About Love (1985)
02 1st Album (1986)
03 In the Middle of Nowhere (1986)
04 Ready for Romance (1986)
05 In the Garden of Venus (1987)
06 Romantic Warriors (1987)
07 Back for Good (1988)
08 Alone (1999)
  
```

6 Press **↑/↓** to select a folder.

■ To play audio files in a folder

Press **▶** to start playing the selected folder.

■ To select an audio file

Press **+**.

The list of files contained in the folder appears.

TRACK LIST

```

 03 In the Middle of Nowher...
  
```

```

01 Geronimo_s_Cadillac
02 Riding_On_A_White_Swan
03 Give_Me_Peace_On_Earth
04 Sweet_Little_Shella
05 Ten_Thousand_Lonely_Drums
06 Lonely_Tears_In_Chinatown
07_In_Shaire
  
```

Press **↑/↓** to select a file and press **+**.

The system starts playing the selected file. You can turn the file list off by pressing **DVD MENU**. Pressing **DVD MENU** again will display the folder list.

Tip

- The system can recognize up to 150 audio files in a single folder.

To go to the next or previous page

Press **→ / ←**.

To stop playback

Press **■**.

To play the next or previous audio file

Press **▶▶** to play the next audio file. Press **◀◀** twice to play the previous audio file.

When you press **◀◀** once, you can go to the beginning of the current audio file.

Note that you can select the next folder by continuing to press ►► after the last file on the current folder, but that you cannot return to the previous folder by pressing ◀◀◀. To return to the previous folder, select the folder from the folder list.

To return to the previous display

Press ⏪ RETURN.

To turn on/off the display

Press DVD MENU.

To select the folder via the remote

During playback or pause, you can select the desired folder quickly by pressing ◻ +/-.

Other operations

See “Other operations” (page 28).

Selecting a JPEG image file or folder

- 1 Press FUNCTION +/- repeatedly until “USB” appears in the front panel display.
- 2 Connect a USB device to the ◀ (USB) port.
After reading all data of the USB device, the list of folders appears on the TV screen.
- 3 Press ◻ DISPLAY.
The Control Menu display appears on the TV screen.
- 4 Press ↑/↓ to select [MEDIA], then press ⊕.
- 5 When [PHOTO] is selected, press DVD MENU. When other than [PHOTO] is selected, press ↑/↓ to select [PHOTO], then press ⊕.

A list of folders that contain JPEG files appears.

The selected folder is highlighted in yellow.

FOLDER LIST	
01	Happy birthday
02	Travelling 01
03	2003.08.20
04	Flowers
05	Travelling 02
06	Animals
07	2003.11.16
08	2003.12.03

6 Press ↑/↓ to select a folder.

■ To go to the next or previous page
Press ●→ / ←●.

■ To play JPEG image files in a folder as a slide show

Press ▷ to start playing the selected folder.

The JPEG images are played as a slide show. You can change the interval of the slide show (page 61), and add effects to the slide show (page 61).

■ To select a JPEG image file by displaying the image browser

Press PICTURE NAVI.

Previews of JPEG image files in the folder appear in 16 subscreens.

1	2	3	4
5	6	7	8
9	10	11	12
13	14	15	16

Press ◀/↑/↓/→ to select the JPEG image file you want to view, then press ⊕.

To return to previous screen, press ⏪ RETURN.

Tip

- The system can recognize up to 150 JPEG image files in a single folder.

To play the next or previous JPEG image file

Press →/← when the Control Menu display is not displayed. Note that you can select the next folder by continuing to press → after the last image on the current folder, but that you cannot return to the previous folder by pressing ←.

return to the previous folder, select the folder from the folder list.

To rotate a JPEG image file

When a JPEG image file is displayed on the TV screen, you can rotate the JPEG image file in 90 degree increments.

Press **↑/↓** while viewing a JPEG image file.

Press **CLEAR** to return to normal view.

Note

- You cannot rotate the JPEG image file when you set [JPEG RESOLUTION] in [HDMI SETUP] to [(1920 × 1080i) HD □] or [(1920 × 1080i) HD].

To stop playback

Press **■**.

To turn on/off the display

Press **DVD MENU**.

To select the folder via the remote

During playback or pause, you can select the desired folder quickly by pressing **□ +/-**.

Other operations

See “Other operations” (page 28).

To select the slide show duration of JPEG image files

1 Press **☰ DISPLAY**.

The Control Menu display appears on the TV screen.

2 Press **↑/↓** to select **📺 [INTERVAL]**, then press **⊕**.

The options for [INTERVAL] appear.

3 Press **↑/↓** to select a setting.

- **[NORMAL]**: You can set to the standard duration.
- **[FAST]**: You can set the duration shorter than [NORMAL].
- **[SLOW 1]**: You can set the duration longer than [NORMAL].
- **[SLOW 2]**: You can set the duration longer than [SLOW 1].

4 Press **⊕**.

Note

- Some JPEG image files may take longer to display than the option you selected. Especially progressive JPEG image files or JPEG image files of 3,000,000 pixels or more.

To select an effect for JPEG image files in the slide show

1 Press **☰ DISPLAY**.

The Control Menu display appears on the TV screen.

2 Press **↑/↓** to select **📺 [EFFECT]**, then press **⊕**.

The options for [EFFECT] appear.

3 Press **↑/↓** to select a setting.

- **[MODE 1]**: The JPEG image file sweeps in from top to bottom.
- **[MODE 2]**: The JPEG image file stretches out from left to right of the TV screen.
- **[MODE 3]**: The JPEG image file stretches out from the center of the TV screen.
- **[MODE 4]**: The JPEG image files randomly cycle through the effects.
- **[MODE 5]**: The next JPEG image file slides over the previous image.
- **[OFF]**: Off.

4 Press **⊕**.

Note

- The [EFFECT] setting is not effective when you set [JPEG RESOLUTION] in [HDMI SETUP] to [(1920 × 1080i) HD □] or [(1920 × 1080i) HD] (page 48).

Selecting a video file or folder

1 Press **FUNCTION +/-** repeatedly until “USB” appears in the front panel display.

2 Connect a USB device to the **↔ (USB)** port.

After reading all data of the USB device, the list of folders appears on the TV screen.

3 Press **☰ DISPLAY**.

The Control Menu display appears on the TV screen.

- 4** Press **↑/↓** to select **[MEDIA]**, then press **+**.

The options for [MEDIA] appear.

- 5** When [VIDEO] is selected, press DVD MENU. When other than [VIDEO] is selected, press **↑/↓** to select [VIDEO], then press **+**.

A list of folders that contain video files appears.

The selected folder is highlighted in yellow.

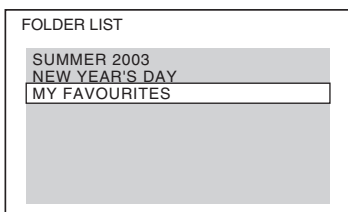

- 6** Press **↑/↓** to select a folder.

■ **To play video files in a folder**

Press **▶** to start playing the selected folder.

■ **To select a video file**

Press **+**.

The list of files contained in the folder appears.

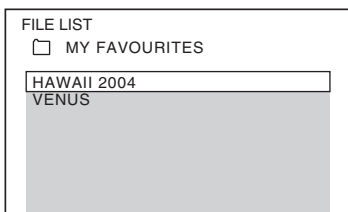

Press **↑/↓** to select a file and press **+**.

The system starts playing the selected file.

You can turn the file list off by pressing DVD MENU. Pressing DVD MENU again will display the folder list.

To go to the next or previous page

Press **→/←**.

To stop playback

Press **■**.

To play the next or previous video file

Press **▶▶** to play the next video file. Press **◀◀** twice to play the previous video file.

When you press **◀◀** once, you can go to the beginning of the current video file.

Note that you can select the next folder by continuing to press **▶▶** after the last file on the current folder, but that you cannot return to the previous folder by pressing **◀◀**. To return to the previous folder, select the folder from the folder list.

To return to the previous display

Press **↶** RETURN.

To turn on/off the display

Press DVD MENU.

To select the folder via the remote

During playback or pause, you can select the desired folder quickly by pressing **□ +/-**.

Other operations

See “Other operations” (page 28).

Note

- For details on video files, see “Enjoying Video Files” (page 41).

Selecting playback priority of the file type

You can select playback priority when mixed media (audio files, JPEG image files, or video files) are in the USB device.

- 1 Press FUNCTION +/- repeatedly until “USB” appears in the front panel display.**
- 2 Connect a USB device to the **↶** (USB) port.**
After reading all data of the USB device, the list of folders appears on the TV screen.
- 3 Press **□** DISPLAY.**
The Control Menu display appears on the TV screen.

- 4** Press **↑/↓** to select  [MEDIA], then press **+**.

The options for [MEDIA] appear.

- 5** Press **↑/↓** to select a setting.

- [MUSIC]: Audio file playback has priority.
- [VIDEO]: Video file playback has priority.
- [PHOTO]: JPEG image file playback has priority. You can play JPEG image files as a slide show.

- 6** Press **+**.

For details of the playback priority of file types under the [MEDIA] setting, see “Playback priority of file types” (page 93).

Displaying the list of audio files/JPEG image files/video files

- 1** Press  **DISPLAY** during playback.

The Control Menu display appears on the TV screen.

- 2** Press **↑/↓** to select  [BROWSING], then press **+**.

The options for [BROWSING] appear.

- 3** Press **↑/↓** to select the desired list, then press **+**.

- [FOLDER LIST]: The list of folders appears. Follow Step 6 of “Selecting an audio file or folder” (page 59), “Selecting a JPEG image file or folder” (page 60), or “Selecting a video file or folder” (page 61).
- [PICTURE LIST] (JPEG image files only): Previews of JPEG image files in the folder appear in 16 subscreens. Follow Step 2 of “Selecting a JPEG image file or folder” (page 60).

Playing repeatedly

(Repeat Play)

You can play the audio files/JPEG image files/video files on the USB device repeatedly.

- 1** Press  **DISPLAY** during playback.

The Control Menu display appears on the TV screen.

- 2** Press **↑/↓** to select  [REPEAT], then press **+**.

The options for [REPEAT] appear.

- 3** Press **↑/↓** to select the item to be repeated.

- [OFF]: Off.
- [MEMORY]: You can repeat all of the folders on the USB device.
- [FOLDER]: You can repeat the current folder.
- [TRACK] (audio files only): You can repeat the current file.
- [FILE] (video files only): You can repeat the current file.

- 4** Press **+**.

The item is selected.

To return to normal play

Press CLEAR, or select [OFF] in Step 3.

To turn off the Control Menu display

Press  **DISPLAY** repeatedly until the Control Menu display is turned off.

Searching for a file or folder

You can search a USB device by audio file, JPEG image file, video file, or folder. As audio files, JPEG image files, and video files are assigned unique numbers on the USB device, you can select the desired audio file, JPEG image file, or video file by entering its number.

- 1** Press  **DISPLAY**.

The Control Menu display appears on the TV screen.

2 Press \uparrow/\downarrow to select the search method.

- [TRACK]: Audio files.
- [FILE]: JPEG image files/video files.
- [FOLDER]: Folders.

[** (**)] is selected (** refers to a number).
The number in parentheses indicates the total number of audio files, JPEG image files, video files, or folders.

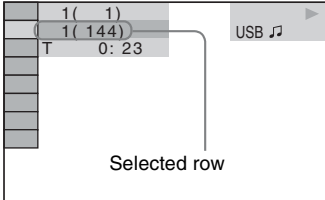

3 Press \oplus .

[** (**)] changes to [-- (**)].

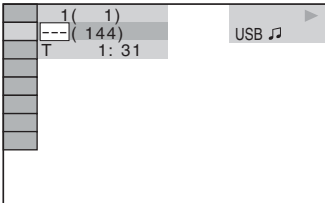

4 Press \uparrow/\downarrow or the number buttons to select the desired number.

If you make a mistake, press CLEAR to cancel the number.

5 Press \oplus .

The system starts playback from the selected number.

Viewing the information of an audio file in the front panel display

Press DISPLAY repeatedly.

Each time you press DISPLAY while playing the USB device, the display changes:

① \leftrightarrow ②

① Playing time and current track number

② Track (file) name*

* If an MP3 file has the ID3 tag, the system will display a folder name/track (file) name from the ID3 tag information.

The system can support ID3 ver 1.0/1.1/2.2/2.3.

ID3 ver 2.2/2.3 tag information display has priority when both ID3 ver 1.0/1.1 and ver 2.2/2.3 tags are used for a single MP3 file.

Note

- If a file name of the audio file cannot be displayed, “*” will appear in the front panel display instead.
- The file name may not be displayed depending on the text.
- Playing time of audio files may not be displayed correctly.

Viewing the information of an audio file/video file on the TV screen

You can display the information of an audio file/video file such as time information, name of the folder/audio file/video file, and the audio bit rate (the amount of data per second of the current audio) on the TV screen.

Press DISPLAY during playback.

The information of an audio file appears on the TV screen.

Example for playback of an audio file

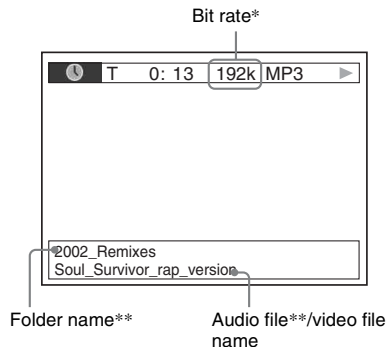

* Appears when playing an audio file.

** If an MP3 file has an ID3 tag, the system will display a folder name/track (file) name from the ID3 tag information.

The system can support ID3 ver 1.0/1.1/2.2/2.3.

ID3 ver 2.2/2.3 tag information display has priority

when both ID3 ver 1.0/1.1 and ver 2.2/2.3 tags are used for a single MP3 file.

Note

- Characters/marks may not be displayed in some languages.
- Depending on the type of file being played, the system can only display a limited number of characters. Also, depending on the file, not all text characters will be displayed.

Checking the date information of a JPEG image file

You can check the date information during playback when the Exif* tag is recorded in the JPEG image file.

Press **DISPLAY** during playback.

The Control Menu display appears on the TV screen.

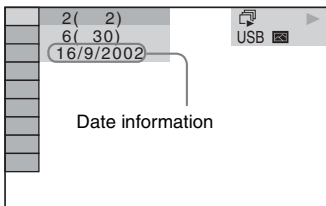

* “Exchangeable Image File Format” is a digital camera image format defined by the Japan Electronics and Information Technology Industries Association (JEITA).

Transferring Songs onto a USB Device

You can transfer songs on an audio CD onto a USB device by encoding to MP3 format. You can also transfer MP3 files on a DATA CD/ DATA DVD onto a USB device.

For connecting the USB device, see “Connecting the USB device” (page 58).

The transferred music is limited to private use only. Use of the music beyond this limit requires permission of the copyright holders.

Notes on USB transferring

- Do not connect the unit and the USB device through a USB hub.
- Make sure there is enough space in the USB device for transferring.
- Do not remove the USB device during transferring.
- When you are transferring tracks from a CD, the tracks are recorded as 128 kbps MP3 files.
- When you are transferring MP3 files from a DATA CD/DATA DVD, the MP3 files are transferred with the same bit rate as the original MP3 files.
- CD text information is not transferred in the created MP3 files.
- If you stop a transfer halfway, the MP3 file that was being created is deleted.
- Transferring stops automatically if:
 - The USB device runs out of space during transfer.
 - The number of MP3 files on the USB device reaches the limit for the number that the system can recognize.
- You can store up to 150 files in a folder.
- You can store up to 199 folders in a single USB device.
- If a folder or file that you are trying to transfer already exists on the USB device with the same name, a sequential number is added after the name without overwriting the original folder or file.

Transferring tracks on an audio CD onto a USB device

- 1 Load an audio CD.
- 2 Press **DISPLAY** while the system is in stop mode.

The Control Menu display appears on the TV screen.

- 3 Press **↑/↓** to select **[USB TRANSFER]**, then press **+**.

- 4 Press **+**.

“READING” appears in the front panel display until the tracks recorded on the audio CD appear on the TV screen.

Note

- It takes several minutes to display the tracks depending on the number of tracks.

- 5 Select a track that you want to transfer.

Remaining space of the USB device

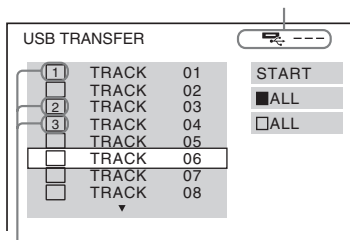

Tracks to be transferred.

■ To select the desired track

Press **↑/↓** to select the track, then press **+**.
The tracks are marked in the order that you select.

■ To select all tracks on the audio CD

Press **←/↑/↓/→** to select **[■ ALL]**, then press **+**.

■ To cancel the track

Press **↑/↓** to select the track, then press **+**.
The mark on the track is removed.

■ To cancel all the tracks

Press **←/↑/↓/→** to select **[□ ALL]**, then press **+**.

- 6 Press **←/↑/↓/→** to select **[START]**, then press **+**.

The system starts transferring and the status of transferring appears.

To cancel transferring, press **■**.

Transferring MP3 files on a DATA CD/DATA DVD onto a USB device

- 1 Load a DATA CD/DATA DVD.

- 2 Press **DISPLAY** while the system is in stop mode.

The Control Menu display appears on the TV screen.

- 3 Press **↑/↓** to select **[USB TRANSFER]**, then press **+**.

- 4 Press **↑/↓** to select **[TRACK]** or **[FOLDER]**, then press **+**.

- **[TRACK]**: The tracks recorded on the DATA CD/DATA DVD appear. You can transfer the desired MP3 files.

- **[FOLDER]**: The folders recorded on the DATA CD/DATA DVD appear. You can transfer all MP3 files in the folder. Go to Step 6.

“READING” appears in the front panel display until the tracks/folders appear on the TV screen.

Note

- It takes several minutes to display the tracks/folders depending on the number of tracks/folders.

- 5 Press **↑/↓** to select the desired folder, then press **+**.

The MP3 files in the selected folder appear.

- 6 Select an MP3 file/folder that you want to transfer.

Remaining space of the USB device



MP3 files/folders to be transferred.

■ To select the desired MP3 file/folder

Press \uparrow/\downarrow to select the MP3 file/folder, then press \oplus .

The MP3 files/folders are marked.

■ To select all MP3 files/folders

Press $\leftarrow/\uparrow/\downarrow/\rightarrow$ to select [ALL], then press \oplus .

■ To cancel the MP3 file/folder

Press \uparrow/\downarrow to select the MP3 file/folder, then press \oplus . The mark on the MP3 file/folder is removed.

■ To cancel all MP3 files/folders

Press $\leftarrow/\uparrow/\downarrow/\rightarrow$ to select [ALL], then press \oplus .

7 Press $\leftarrow/\uparrow/\downarrow/\rightarrow$ to select [START], then press \oplus .

The system starts transferring and the transferring status appears.

To cancel transferring, press ■.

Transferring by single button press

You can transfer tracks/MP3 files simply onto a USB device by using REC TO USB.

To transfer all tracks on an audio CD or all MP3 files onto a USB device

Tracks on an audio CD are transferred onto a USB device by encoding to MP3 format.

1 Load an audio CD/DATA CD/DATA DVD.

2 Press ■.

3 Press REC TO USB on the unit.

REC TO USB lights up and “READING” appears in the front panel display. Then, “PUSH PLAY” and the remaining space of the USB device appear alternately in the front panel display.

4 Press \blacktriangleright on the unit.

Transferring starts.

When transferring is completed, “COMPLETE” appears in the front panel display and the disc and the USB device stop automatically.

To cancel transferring, press ■.

To transfer a single track on an audio CD or a single MP3 file onto a USB device

You can transfer the track/MP3 file that is currently playing back. A track on an audio CD is transferred onto a USB device by encoding to MP3 format.

1 Load an audio CD/DATA CD/DATA DVD.

2 Select the desired track/MP3 file, then press \blacktriangleright .

Playback of the selected track/MP3 file starts.

3 Press REC TO USB on the unit.

REC TO USB lights up and “READING” appears in the front panel display. Then, “PUSH PLAY” and the remaining space of the USB device appear alternately in the front panel display.

4 Press \blacktriangleright on the unit.

Transferring of the selected track/MP3 file starts.

When transferring is completed, “COMPLETE” appears in the front panel display and the disc and the USB device stop automatically.

To cancel transferring, press ■.

Folder and file generation rules

When transferring onto a USB device, a “MUSIC” folder is created directly below the “ROOT”. Folders and files are generated within this “MUSIC” folder as follows according to the transferring method and source.

- When transferring all tracks on an audio CD or all MP3 files on a DATA CD/DATA DVD

Source	Folder name	File name
MP3	Same as the transferring source ¹⁾	
Audio CD	“FLDR001” ²⁾	“TRACK001” ³⁾

- When transferring a single track on an audio CD or a single MP3 file on a DATA CD/DATA DVD

Source	Folder name	File name
MP3	“REC1-MP3” ⁴⁾	Same as the transferring source ¹⁾
Audio CD	“REC1-CD” ⁴⁾	“TRACK001” ³⁾

¹⁾Up to 64 characters of the name are assigned (including the extension).

²⁾Folders are assigned in numeric order thereafter.

³⁾Files are assigned in numeric order thereafter.

⁴⁾A new file is transferred in the “REC1-MP3” or “REC1-CD” folder each time REC1 transferring is performed.

Erasing audio files on a USB device

You can erase audio files (“.mp3,” “.wma,” or “.m4a”) on the USB device.

1 Press **FUNCTION +/-** repeatedly until “USB” appears in the front panel display.

2 Press **↑/↓** to select a folder.

■ **To erase all audio files in a folder**
Press **CLEAR**.

■ **To erase an audio file**
Press **⊕**.

The list of files contained in the folder appears.

Press **↑/↓** to select the desired audio file, then press **CLEAR**.

3 Press **←/→** to select **[YES]**, then press **⊕**.

To cancel, select **[NO]**, then press **⊕**.

Note

- Do not remove the USB device while erasing.
- If the folder to be erased contains non-audio format files or sub folders, these are erased from the list on the TV screen, but are not erased from the USB device.

Using a Sony Ericsson Mobile Phone

You can connect a Sony Ericsson mobile phone to the system and enjoy music from it via this system, or transfer music from this system to the mobile phone.

1 Connect the mobile phone to the  (USB) port.

2 Set the data transfer mode of your mobile phone to File Transfer (Mass Storage).

For details, refer to the operating instructions supplied with the mobile phone.

3 Perform playback or transfer via the system.

- Playback: See “Playing Back Files of a USB Device” (page 57).
- Transferring: See “Transferring Songs onto a USB Device” (page 65)

Note

- Connect to this system with the mobile phone turned on.
- Use the USB cable supplied with the mobile phone when connecting to the system.
- While the mobile phone is connected to this system, do not insert or detach the memory card.
- Some files supported by the mobile phone may not be supported by the system.
- When a song is registered in a music playlist on your mobile phone and you erase the song via this system, the playlist entry is not modified.

Using the DIGITAL MEDIA PORT Adapter

The DIGITAL MEDIA PORT (DMPORT) adapter is for enjoying sound from a portable audio source or computer. By connecting a DIGITAL MEDIA PORT adapter, you can enjoy sound from the connected component on the system.

Available DIGITAL MEDIA PORT adapters vary in each area.

For details on connecting the DIGITAL MEDIA PORT adapter, see page 17.

Note

- Do not connect an adapter other than the DIGITAL MEDIA PORT adapter.
- Do not connect or disconnect the DIGITAL MEDIA PORT adapter to/from the unit while the system is turned on.

Playing the connected component on the system

1 Press FUNCTION +/- repeatedly until “DMPORT” appears in the front panel display.

2 Start playback of the connected component.

The sound and images from the connected component are played on the system or connected TV.

For operation details, refer to the operating instructions of the DIGITAL MEDIA PORT adapter.

Note

- Depending on the type of DIGITAL MEDIA PORT adapter, images are also output. In this case, the system outputs the EURO AV  OUTPUT (TO TV) signal only regardless of the type of video signal

Tip

- Depending on the type of DIGITAL MEDIA PORT adapter, you may be able to operate a connected component using either the buttons on the remote or the unit. The following illustration shows an example of buttons that can be used in this case.

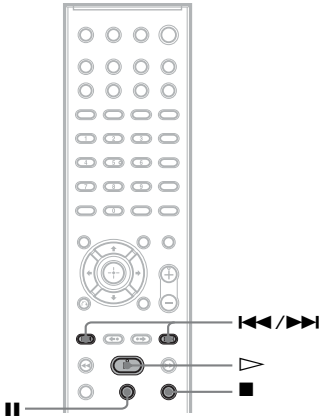

Getting Optimal Surround Sound for a Room

[SPEAKER FORMATION]

Depending on the shape of the room, you cannot install some speakers. For better surround sound, Sony recommends that first you decide the position of the speakers.

1 Press **FUNCTION +/-** repeatedly until “DVD” appears in the front panel display.

2 Press **☺ DISPLAY** while the system is in stop mode.

The Control Menu display appears on the TV screen.

3 Press **↑/↓** to select **🏠 [SETUP]**, then press **⊕**.

The options for [SETUP] appear.

4 Press **↑/↓** to select **[CUSTOM]**, then press **⊕**.

The Setup Display appears.

5 Press **↑/↓** to select **[AUDIO SETUP]**, then press **⊕**.

The options for [AUDIO SETUP] appear.

6 Press **↑/↓** to select **[SPEAKER FORMATION]**, then press **⊕**.

The options for [SPEAKER FORMATION] appear.

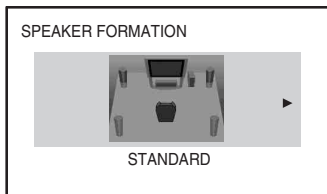

7 Press **←/→** to select a setting.

- [STANDARD]: Select this when you install all the speakers normally.
- [NO CENTER]: Select this when you install the front and surround speakers only.
- [NO SURROUND]: Select this when you install the center and front speakers only.
- [FRONT ONLY]: Select this when you install the front speakers only.
- [ALL FRONT]: Select this when you install all the speakers in front of the listening position.
- [ALL FRONT - NO CENTER]: Select this when you install the front and surround speakers in front of the listening position.

8 Press **⊕**.

Controlling the TV with the Supplied Remote

You can control the TV (Sony only) by using the following buttons. Use these buttons (other than TV I/O, THEATRE, and TV INPUT) while pressing the TV button.

Note

- Depending on the TV, you may not be able to control your TV or to use some of the buttons.

By pressing	You can
TV I/O	Turn the TV on/off.
THEATRE	Enjoy optimal image quality suited for movies.
TV INPUT	Switch the TV's input source between the TV and other input sources.
VOLUME +/-*	Adjust the TV volume.
PROG +/-*	Select the TV channel.
Number buttons*, -/ -* ENTER*	Select the TV channel.
TOOLS*	Displays the operation menu for the current display.
RETURN*	Return to the previous channel or layer on the menu of the TV.
MENU*	Display the menu of the TV.
MUTING*	Turn off the TV sound temporarily.
←/↑/↓/→*, ⊕ *	Select the item on the menu.

* Use these buttons while pressing the TV button.

Using the Sound Effect

Reinforcing bass frequencies

You can reinforce bass frequencies.

Press **DYNAMIC BASS**.

“D. BASS ON” appears in the front panel display and bass frequencies are effectively reinforced.

To turn off the sound effect

Press **DYNAMIC BASS** again.

Enjoying the sound at low volume

You can enjoy sound effects or dialogue, as you would in a movie theater, even at low volume. It is useful for watching movies at night.

Press **NIGHT**.

“NIGHT ON” appears in the front panel display and the sound effect is activated.

Note

- This effect does not work for a Super Audio CD. When you load a Super Audio CD during “NIGHT ON,” the sound effect turns off automatically.
- When sound is output from the center speaker, this effect is more pronounced, as speech (movie dialog, etc.) is easy to hear. When sound is not output from the center speaker, or you are using the headphones, the system optimally adjusts the volume.

To turn off the sound effect

Press **NIGHT** again.

Enhancing compressed sound

You can enhance compressed sound such as an MP3 audio file.

This effect is activated automatically when all the following conditions are satisfied:

- The function is set to “DMPORT,” “AUDIO,” or “USB”.

- “DEC. MODE” is set to “A.F.D. STD” or “A.F.D. MULTI.”
- Headphones are not connected.

To turn off the sound effect

Select other than “A.F.D. STD” or “A.F.D. MULTI” for “DEC. MODE” (page 24).

Selecting the Effect to Suit the Source

You can select a suitable sound mode for movies or music.

Press SOUND MODE repeatedly during playback until the desired mode appears in the front panel display.

- “AUTO”: The system automatically selects “MOVIE” (the MOVIE indicator lights up) or “MUSIC” (the MUSIC indicator lights up) to produce the sound effect depending on the source.
- “MOVIE”: The system provides the sound for movies. The MOVIE indicator lights up.
- “MUSIC”: The system provides the sound for music. The MUSIC indicator lights up.

Note

- When you play a Super Audio CD, this function does not work.
- You cannot operate these setup items when you connect headphones to the unit.

Changing the Input Level of the Sound from Connected Components

Distortion may occur when you listen to a component connected to the EURO AV  OUTPUT (TO TV) jack on the rear panel, or to the AUDIO IN jack on the front panel.

Distortion is not a malfunction and will depend on the component connected.

To prevent distortion, reduce the input level on the unit.

1 Press **FUNCTION +/-** repeatedly until “TV” or “AUDIO” appears in the front panel display.

2 Press **SYSTEM MENU**.

3 Press **↑/↓** repeatedly until “ATTENUATE” appears in the front panel display, then press **⊕** or **→**.

4 Press **↑/↓** to select a setting.

- “ATT ON”: You can attenuate the input level. The output level is changed.
- “ATT OFF”: Normal input level.

5 Press **⊕**.

The setting is made.

6 Press **SYSTEM MENU**.

The system menu turns off.

Using the Sleep Timer

You can set the system to turn off at a preset time, so you can fall asleep listening to music. You can preset the time in 1 or 10-minute increments.

Press SLEEP.

Each time you press SLEEP, the minutes display (the remaining time) changes by 10 minutes.

When you set the sleep timer, “SLEEP” flashes in the front panel display.

To check the remaining time

Press SLEEP once.

To change the remaining time

Press SLEEP repeatedly to select the desired time.

To cancel the sleep timer function

Press SLEEP repeatedly until “SLEEP OFF” appears in the front panel display.

To set the sleep timer using the system menu

1 Press **SYSTEM MENU**.

2 Press **↑/↓** repeatedly until “SLEEP” appears in the front panel display, then press **⊕** or **→**.

3 Press **↑/↓** to select a setting.

The minutes display (the remaining time) changes by 10 minutes.

Tip

- You can select the remaining time by pressing the number buttons. In this case, you can preset the time in 1-minute increments.

4 Press **⊖**.

The setting is made and “SLEEP” flashes in the front panel display.

5 Press **SYSTEM MENU**.

The system menu turns off.

Changing the Brightness of the Front Panel Display

You can set the brightness of the front panel display to either of 2 levels.

Press **DIMMER**.

Each time you press DIMMER, the brightness of the front panel display changes.

To set the brightness of the front panel display using the system menu

- 1 Press **SYSTEM MENU**.
- 2 Press **↑/↓** repeatedly until “**DIMMER**” appears in the front panel display, then press **+** or **→**.
- 3 Press **↑/↓** to select the brightness of the front panel display.
 - “**DIMMER OFF**”: The front panel display is bright.
 - “**DIMMER ON**”: The front panel display is dark.
- 4 Press **+**.

The setting is made.
- 5 Press **SYSTEM MENU**.

The system menu turns off.

Viewing Information About the Disc



Viewing the playing time and remaining time in the front panel display

Press **DISPLAY** repeatedly.

Each time you press DISPLAY while playing the disc, the display changes:

① → ② → ... → ① → ...

Some displayed items may disappear after a few seconds.

■ DVD VIDEO/DVD-VR

- ① Playing time of the current title
- ② Remaining time of the current title
- ③ Playing time of the current chapter
- ④ Remaining time of the current chapter
- ⑤ Disc name
- ⑥ Title and chapter

■ VIDEO CD (without PBC functions)/Super Audio CD/CD

- ① Playing time of the current track
- ② Remaining time of the current track
- ③ Playing time of the disc
- ④ Remaining time of the disc
- ⑤ Track name
- ⑥ Track and index*

* VIDEO CD/Super Audio CD only.

■ Super VCD

- ① Playing time of the current track
- ② Track text
- ③ Track and index number

■ DATA CD (MP3 file)/DATA DVD (MP3 file)

- ① Playing time and current track number
- ② Track (file) name*

* If an MP3 file has an ID3 tag, the system will display an album name or title name from the ID3 tag information.

The system can support ID3 ver 1.0/1.1/2.2/2.3. ID3 ver 2.2/2.3 tag information display has priority when both ID3 ver 1.0/1.1 and ver 2.2/2.3 tags are used for a single MP3 file.

■ DATA CD (video file)/DATA DVD (video file)

- ① Playing time of the current file
- ② Current file name
- ③ Current album and file number

Note

- The system can only display the first level of the DVD/CD text, such as the disc name or title.
- If a file name of the MP3 file cannot be displayed, “*” will appear in the front panel display instead.
- The disc name or track name may not be displayed depending on the text.
- Playing time of MP3 files and video files may not be displayed correctly.

Tip

- When the system is playing a VIDEO CD with PBC functions, the playing time is displayed.

Viewing the playing time and remaining time on the TV screen

1 Press DISPLAY during playback.

The following display appears on the TV screen.

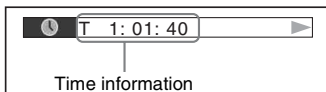

2 Press DISPLAY repeatedly to change the time information.

The display and the kinds of time that you can check depend on the disc you are playing.

■ DVD VIDEO/DVD-VR

- T **: **: **
Playing time of the current title
- T_ **: **: **
Remaining time of the current title
- C **: **: **
Playing time of the current chapter
- C_ **: **: **
Remaining time of the current chapter

■ VIDEO CD (with PBC functions)

- **: **: **
Playing time of the current scene

■ VIDEO CD (without PBC functions)/Super Audio CD/CD

- T **: **: **
Playing time of the current track
- T_ **: **: **
Remaining time of the current track
- D **: **: **
Playing time of the current disc
- D_ **: **: **
Remaining time of the current disc

■ DATA CD (MP3 file)/DATA DVD (MP3 file)

- T **: **: **
Playing time of the current track

■ DATA CD (video file)/DATA DVD (video file)

- **: **: **: **
Playing time of the current file

Note

- Characters/marks may not be displayed in some languages.
- Depending on the type of disc being played, the system can only display a limited number of characters. Also, depending on the disc, not all text characters will be displayed.

Checking the play information of the disc

To check DVD/Super Audio CD/CD text

Press DISPLAY repeatedly during playback to display text recorded in the DVD/Super Audio CD/CD.

The DVD/Super Audio CD/CD text appears only when text is recorded in the disc. You cannot change the text. If the disc does not contain text, “NO TEXT” appears.

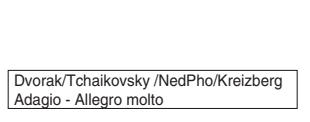

To check DATA CD/DATA DVD (MP3 file/video file) text

By pressing DISPLAY while playing MP3 files or video files on a DATA CD/DATA DVD, you can display the name of the folder/MP3 file/video file, and the audio bit rate (the amount of data per second of the current audio) on the TV screen.

Example for playback of an audio file

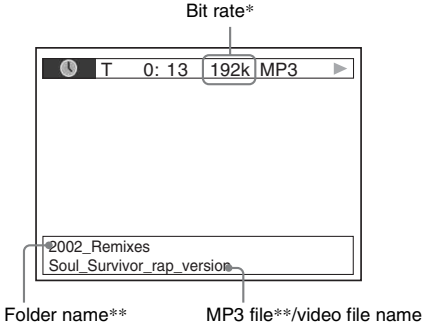

* Appears when playing an MP3 file on a DATA CD/DATA DVD.

** If an MP3 file has the ID3 tag, the system will display an album name or title name from the ID3 tag information.
The system can support ID3 ver 1.0/1.1/2.2/2.3. ID3 ver 2.2/2.3 tag information display has priority when both ID3 ver 1.0/1.1 and ver 2.2/2.3 tags are used for a single MP3 file.

* “Exchangeable Image File Format” is a digital camera image format defined by the Japan Electronics and Information Technology Industries Association (JEITA).

Checking the date information of a JPEG image file

You can check the date information during playback when the Exif* tag is recorded in the JPEG image file.

Press **DISPLAY** during playback.

The Control Menu display appears on the TV screen.

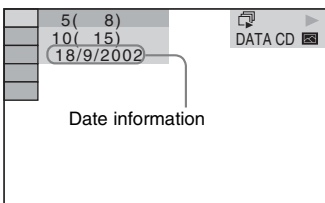

Returning to the Default Settings

Returning the system parameters, such as preset stations, to the default settings

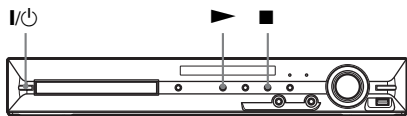





- 1 Press I/O to turn on the system.**
- 2 Press ■, ►, and I/O on the unit at the same time.**



“COLD RESET” appears in the front panel display and the system returns to default settings.

Returning the [SETUP] settings to the default



You can return the [SETUP] settings (page 45) other than [PARENTAL CONTROL] to the default settings.



- 1 Press FUNCTION +/- repeatedly until “DVD” appears in the front panel display.**
- 2 Press  DISPLAY while the system is in stop mode.**

The Control Menu display appears on the TV screen.
- 3 Press  to select  [SETUP], then press .**

The options for [SETUP] appear.
- 4 Press  to select [CUSTOM], then press .**

The Setup Display appears.

- 5 Press  to select [SYSTEM SETUP], then press .**

The options for [SYSTEM SETUP] appear.
- 6 Press  to select [RESET] and press .**
- 7 Press  to select [YES].**

You can also quit the process and return to the Control Menu display by selecting [NO] here.
- 8 Press .**

Do not press I/O while resetting the system as it takes a few seconds to complete.

Note

- The [MEDIA], [INTERVAL], [EFFECT], and [MULTI/2CH] settings also return to the default settings.

Precautions

On power sources

- Unplug the unit from the wall outlet (mains) if you do not intend to use it for an extended period of time. To disconnect the cord, pull it out by the plug, never by the cord.

On placement

- Place the system in a location with adequate ventilation to prevent heat build-up in the system.
- At high volume, over long periods of time, the cabinet becomes hot to the touch. This is not a malfunction. However, touching the cabinet should be avoided. Do not place the system in a confined space where ventilation is poor as this may cause overheating.
- Do not block the ventilation slots by putting anything on the system. The system is equipped with a high power amplifier. If the ventilation slots are blocked, the system can overheat and malfunction.
- Do not place the system on surfaces (rugs, blankets, etc.) or near materials (curtains, draperies) that may block the ventilation slots.
- Do not install the system near heat sources such as radiators, or air ducts, or in a place subject to direct sunlight, excessive dust, mechanical vibration, or shock.
- Do not install the system in an inclined position. It is designed to be operated in a horizontal position only.
- Keep the system and discs away from components with strong magnets, such as microwave ovens, or large loudspeakers.
- Do not place heavy objects on the system.

On operation

- If the system is brought directly from a cold to a warm location, or is placed in a very damp room, moisture may condense on the lenses inside the unit. Should this occur, the system may not operate properly. In this case, remove the disc and leave the system turned on for about half an hour until the moisture evaporates.
- When you move the system, take out any disc. If you don't, the disc may be damaged.
- If anything falls into the cabinet, unplug the unit and have it checked by qualified personnel before operating it any further.

On adjusting volume

- Do not turn up the volume while listening to a section with very low level inputs or no audio signals. If you do, the speakers may be damaged when a peak level section is suddenly played.

On cleaning

- Clean the cabinet, panel, and controls with a soft cloth slightly moistened with a mild detergent solution. Do not use any type of abrasive pad, scouring powder or solvent such as alcohol or benzene.
If you have any questions or problems concerning your system, please consult your nearest Sony dealer.

On cleaning discs, disc/lens cleaners

- **Do not use cleaning discs or disc/lens cleaners (including wet or spray types). These may cause the apparatus to malfunction.**

On your TV's color

- If the speakers should cause the TV screen to have color irregularity, turn off the TV then turn it on after 15 to 30 minutes. If color irregularity should persist, place the speakers further away from the TV set.

IMPORTANT NOTICE

Caution: This system is capable of holding a still video image or on-screen display image on your television screen indefinitely. If you leave the still video image or on-screen display image displayed on your TV for an extended period of time you risk permanent damage to your television screen. Projection televisions are especially susceptible to this.

On moving the system

Before moving the system, make sure that there is no disc inserted, and remove the AC power cord (mains lead) from the wall outlet (mains).

Notes about the Discs

On handling discs

- To keep the disc clean, handle the disc by its edge. Do not touch the surface.
- Do not stick paper or tape on the disc.



- Do not expose the disc to direct sunlight or heat sources such as hot air ducts, or leave it in a car parked in direct sunlight as the temperature may rise considerably inside the car.
- After playing, store the disc in its case.

On cleaning

- Before playing, clean the disc with a cleaning cloth. Wipe the disc from the center out.



- Do not use solvents such as benzine, thinner, commercially available cleaners, or anti-static spray intended for vinyl LPs.

This system can only play back a standard circular disc. Using neither standard nor circular discs (e.g., card, heart, or star shape) may cause a malfunction.

Do not use a disc that has a commercially available accessory attached, such as a label or ring.

Troubleshooting

If you experience any of the following difficulties while using the system, use this troubleshooting guide to help remedy the problem before requesting repairs. Should any problem persist, consult your nearest Sony dealer.

Note that if service personnel changes some parts during repair, these parts may be retained.

Power

Symptom	Remedy
The power is not turned on.	<ul style="list-style-type: none"> • Check that the AC power cord (mains lead) is connected securely. • Press I/⏻ after “STANDBY” disappears from the front panel display.
If “PROTECTOR” and “PUSH POWER” appear alternately in the front panel display.	<p>Press I/⏻ to turn off the system, and check the following items after “STANDBY” disappears.</p> <ul style="list-style-type: none"> • Are the + and – speaker cords short-circuited? • Are you using only the specified speakers? • Is anything blocking the ventilation holes of the system? • After checking the above items and fixing any problems, turn on the system. If the cause of the problem cannot be found even after checking all the above items, consult your nearest Sony dealer.

Picture

Symptom	Remedy
There is no picture.	<ul style="list-style-type: none"> • The SCART (EURO AV) cable is not connected securely. • The SCART (EURO AV) cable is damaged. • The unit is not connected to the correct EURO AV ↔ OUTPUT (TO TV) jack (page 16). • The video input on the TV is not set so that you can view pictures from the system. • Check the output method on your system (page 16). • Re-connect the connecting cord securely. • The unit is connected to an input device that is not HDCP (High-bandwidth Digital Content Protection) compliant (“HDMI” on the front panel does not light up) (page 16). • If the HDMI OUT jack is used for video output, change the type of video signal output from the HDMI OUT jack. It may solve the problem (page 22). Connect the TV and the unit using a video jack other than the HDMI OUT, and switch the TV’s input to the connected video input so that you can see the on-screen displays. Change the type of video signal output from the HDMI OUT jack, and switch the TV’s input back to HDMI. If the picture still does not appear, repeat the Steps and try other options. • If you are using the “DMPOR” function, the video signal is output from the EURO AV ↔ OUTPUT (TO TV) jack only.
Picture noise appears.	<ul style="list-style-type: none"> • The disc is dirty or flawed. • If the signal from the EURO AV ↔ OUTPUT (TO TV) jack is distorted, change the type of video signal output from the HDMI OUT jack by setting [HDMI RESOLUTION] in [HDMI SETUP] to [720 × 480p]* (page 22). * Depending on the area, [720 × 480/576p] may appear.

Symptom	Remedy
Even though you set the aspect ratio in [TV TYPE] of [VIDEO SETUP], the picture does not fill the TV screen.	<ul style="list-style-type: none"> • The aspect ratio on the disc is fixed.
Color irregularity occurs on the TV screen.	<p>The system's speakers contain magnet parts, so magnetic distortion may occur. When color irregularity occurs on the TV screen, check the following items.</p> <ul style="list-style-type: none"> • If the speakers are used with a CRT-based TV or projector, install the speakers at least 0.3 meters (1.0 ft) from the TV set. • If the color irregularity persists, turn off the TV set once, then turn it on after 15 to 30 minutes. • If howling occurs, reposition the speakers farther away from the TV set. • Make sure that no magnetic object (magnetic latch on a TV stand, health care device, toy, etc.) is placed near the speakers.

Sound

Symptom	Remedy
There is no sound.	<ul style="list-style-type: none"> • The speaker cord is not connected securely. • Press MUTE on the remote if "MUTING ON" is displayed in the front panel display. • The system is in pause mode or in Slow-motion Play mode. Press ▷ to return to normal play mode. • Fast forward or fast reverse is being performed. Press ▷ to return to normal play mode. • Check the speaker settings (page 50). • Super Audio CD audio signals are not output from the HDMI OUT jack. • The component connected to the HDMI OUT jack does not conform to the audio signal format, in this case set [AUDIO (HDMI)] in [HDMI SETUP] to [ON] (page 48).
No sound is output from the HDMI OUT jack.	<ul style="list-style-type: none"> • Set [AUDIO (HDMI)] in [HDMI SETUP] to [ON] (page 48). • The HDMI OUT jack is connected to a DVI (Digital Visual Interface) device (DVI (Digital Visual Interface) jacks do not accept audio signals). • The HDMI OUT jack does not output Super Audio CD sound. • Try the following: ① Turn the system off and on again. ② Turn the connected component off and on again. ③ Disconnect and then connect the HDMI cable again.
The left and right sounds are unbalanced or reversed.	<ul style="list-style-type: none"> • Check that the speakers and components are connected correctly and securely.
There is no sound from the subwoofer.	<ul style="list-style-type: none"> • Check the speaker connections and settings (pages 15, 50).
Severe hum or noise is heard.	<ul style="list-style-type: none"> • Check that the speakers and components are connected securely. • Check that the connecting cords are away from a transformer or motor, and at least 3 meters (10 ft) away from your TV set or a fluorescent light. • Move your TV away from the audio components. • The plugs and jacks are dirty. Wipe them with a cloth slightly moistened with alcohol. • Clean the disc.
The sound loses stereo effect when you play a VIDEO CD, a CD, or an MP3 file.	<ul style="list-style-type: none"> • Select stereo sound by pressing AUDIO (page 29). • Make sure the unit is connected properly.

Symptom	Remedy
The surround effect is difficult to hear when you are playing a sound track of Dolby Digital, DTS, or MPEG audio.	<ul style="list-style-type: none"> • Check the “DEC. MODE” setting (page 24). • Check the speaker connections and settings (pages 15, 50). • Depending on the DVD, the output signal may not be the entire 5.1 channel. It may be monaural or stereo even if the sound track is recorded in Dolby Digital or MPEG audio format.
The sound comes from the center speaker only.	<ul style="list-style-type: none"> • Depending on the disc, the sound may come from the center speaker only.
No sound is heard from the center speaker.	<ul style="list-style-type: none"> • Check the speaker connections and settings (pages 15, 50). • Check the “DEC. MODE” setting (page 24). • Depending on the source, the effect of the center speaker may be less noticeable. • A 2 channel source is being played.
No sound or only a very low-level sound is heard from the surround speakers.	<ul style="list-style-type: none"> • Check the speaker connections and settings (pages 15, 50). • Check the “DEC. MODE” setting (page 24). • Depending on the source, the effect of the surround speakers may be less noticeable. • A 2 channel source is being played.



Operation



Symptom	Remedy
Radio stations cannot be tuned in.	<ul style="list-style-type: none"> • Check that the antenna (aerial) is connected securely. Adjust the antenna (aerial) or connect an external antenna (aerial) if necessary. • The signal strength of the stations is too weak (when tuning in with automatic tuning). Use direct tuning. • No stations have been preset or the preset stations have been cleared (when tuning by scanning preset stations). Preset the stations (page 52).
The remote does not function.	<ul style="list-style-type: none"> • There are obstacles between the remote and the unit. • The distance between the remote and the unit is too far. • The remote is not pointed at the remote sensor on the unit. • The batteries in the remote are weak.
The disc does not play.	<ul style="list-style-type: none"> • There is no disc inserted. • The disc is upside down. Insert the disc with the playback side facing down. • The disc is skewed on the disc tray. • The system cannot play CD-ROMs, etc. (page 6). • The region code on the DVD does not match the system. • Moisture has condensed inside the unit and may cause damage to the lenses. Remove the disc and leave the unit turned on for about half an hour.
The MP3 file cannot be played.	<ul style="list-style-type: none"> • The DATA CD is not recorded in ISO 9660 Level 1/Level 2, or Joliet. • The DATA DVD is not recorded in UDF (Universal Disk Format). • The MP3 file does not have the extension “.mp3.” • The data is not formatted in MP3 even though it has the extension “.mp3.” • The data is not MPEG1 Audio Layer 3 data. • The system cannot play audio tracks in MP3PRO format. • If you cannot change the [MEDIA] setting, re-load the disc or turn the system off, then on.

Symptom	Remedy
The JPEG image file cannot be played.	<ul style="list-style-type: none"> • The DATA CD is not recorded in ISO 9660 Level 1/Level 2, or Joliet. • The DATA DVD is not recorded in UDF (Universal Disk Format). • It has an extension other than “.jpeg” or “.jpg.” • It is larger than 3,072 (width) × 2,048 (height) in normal mode, or more than 2,000,000 pixels in progressive JPEG image file which is mainly used on Internet Web sites. • It does not fit the TV screen (those images are reduced). • If you cannot change the [MEDIA] setting, re-load the disc or turn the system off, then on.
The video file cannot be played.	<ul style="list-style-type: none"> • The file is not created in DivX format or MP4 file format. • The file has an extension other than “.avi,” “.divx,” “.mp4,” or “.m4v.” • The DATA CD/DATA DVD is not created in ISO 9660 Level 1/Level 2, or Joliet/UDF. • The video file is larger than 720 (width) × 576 (height).
The titles of folder/file/file name are not displayed correctly.	<ul style="list-style-type: none"> • The system can only display numbers and letters of the alphabet. Other characters are displayed as [*].
A disc does not start playing from the beginning.	<ul style="list-style-type: none"> • Program Play, Shuffle Play, or Repeat Play has been selected. Press CLEAR to cancel these functions before playing a disc. • Resume Play has been selected. During stop, press ■ on the unit or the remote and then start playback (page 31). • The title, DVD or PBC menu automatically appears on the TV screen.
The system starts playing the disc automatically.	<ul style="list-style-type: none"> • The DVD features an auto playback function.
Playback stops automatically.	<ul style="list-style-type: none"> • Some discs may contain an auto pause signal. While playing such a disc, the system stops playback at the auto pause signal.
You cannot perform some functions such as stop, search, Slow-motion Play, or Repeat Play.	<ul style="list-style-type: none"> • Depending on the disc, you may not be able to perform some of these operations. Refer to the operating instructions supplied with the disc.
Messages do not appear on the TV screen in the language you want.	<ul style="list-style-type: none"> • In the Setup Display, select the desired language for the on-screen display in [OSD] under [LANGUAGE SETUP] (page 46).
The language for the sound track cannot be changed.	<ul style="list-style-type: none"> • Multilingual tracks are not recorded on the DVD being played. • The DVD prohibits changing the language for the sound track.
The subtitle language cannot be changed.	<ul style="list-style-type: none"> • Multilingual subtitles are not recorded on the DVD being played. • The DVD prohibits changing the subtitles.
The subtitle cannot be turned off.	<ul style="list-style-type: none"> • The DVD prohibits turning off subtitles.
The angles cannot be changed.	<ul style="list-style-type: none"> • Multi-angles are not recorded on the DVD being played (page 28). • The DVD prohibits changing the angles.
A disc cannot be ejected and “LOCKED” appears in the front panel display.	<ul style="list-style-type: none"> • Contact your Sony dealer or local authorized Sony service facility.

Symptom	Remedy
[Data error] appears on the TV screen when playing a DATA CD or DATA DVD.	<ul style="list-style-type: none"> • The MP3 file/JPEG image file/video file you want to play is broken. • The data is not MPEG1 Audio Layer 3 data. • The JPEG image file format does not conform to DCF. • The file has the extension “.jpg” or “.jpeg,” but is not in JPEG format. • The file you want to play has the extension “.avi” or “.divx” but is not in DivX format, or is in DivX format but does not conform to DivX Certified profiles. • The file you want to play has the extension “.mp4” or “.m4v” but is not in MP4 format, or is in MP4 format but does not conform to MPEG4 Simple Profiles.
The system does not work normally.	<ul style="list-style-type: none"> • Disconnect the AC power cord (mains lead) from the wall outlet (mains), then reconnect after several minutes.
The Control for HDMI function does not work.	<ul style="list-style-type: none"> • When “HDMI” does not light up in the front panel display, check the HDMI connection (page 16). • Set [CONTROL FOR HDMI] in [HDMI SETUP] to [ON] (page 47). • Make sure that the connected component is compatible with the [CONTROL FOR HDMI] function. • Check that the AC power cord (mains lead) of the connected component is connected securely. • Check the connected component’s setting for the Control for HDMI function. Refer to the operating instructions supplied with the component. • If you change the HDMI connection, connect and disconnect the AC power cord (mains lead), or have a power failure, set [CONTROL FOR HDMI] in [HDMI SETUP] to [OFF], then set [CONTROL FOR HDMI] in [HDMI SETUP] to [ON] (page 47). • For details, see “Using the Control for HDMI Function for “BRAVIA” Sync” (page 55).
No sound is output from the system and TV while using the System Audio Control function.	<ul style="list-style-type: none"> • Set [AUDIO (HDMI)] in [HDMI SETUP] to [ON] (page 48). • Make sure that the connected TV is compatible with the System Audio Control function. • For details, see “Using the Control for HDMI Function for “BRAVIA” Sync” (page 55).
The TV input select does not change automatically when you connect the system and TV with a SCART (EURO AV) cable.	<ul style="list-style-type: none"> • Set [CONTROL FOR HDMI] in [HDMI SETUP] to [OFF] (page 47).

USB device

Symptom	Remedy
“OVERLOAD,” “REMOVE USB,” then “PUSH POWER” appear in the front panel display.	<ul style="list-style-type: none"> • A problem has been detected with the level of electrical current from the  (USB) port. Turn off the system and remove the USB device from the  (USB) port. Make sure there is no problem with the USB device. If this display pattern persists, contact your nearest Sony dealer.
Are you using a supported USB device?	<ul style="list-style-type: none"> • If you connect an unsupported USB device, the following problems may occur. See “Playable USB Devices” (supplement) for the supported device types. <ul style="list-style-type: none"> – The USB device is not recognized. – File or folder names are not displayed on this system. – Playback is not possible. – The sound skips. – There is noise. – A distorted sound is output. – Transferring stops before it is finished.

Symptom	Remedy
There is no sound.	<ul style="list-style-type: none"> • The USB device is not connected correctly. Turn off the system, then reconnect the USB device.
The sound is distorted.	<ul style="list-style-type: none"> • The bit rate used when encoding the audio files was low. Transfer audio files encoded with higher bit rates onto the USB device.
There is noise or the sound skips.	<ul style="list-style-type: none"> • Turn off the system, then reconnect the USB device. • Noise may have entered during the transferring process. Delete the file, and try transferring again. • Copy the files to your computer, format the USB device in FAT12, FAT16, or FAT32 format, and transfer the files to the USB device again.* * This system supports FAT12, FAT16, and FAT32, but some USB devices may not support all of these. For details, refer to the operating instructions of each USB device or contact the manufacturer.
The USB device cannot be connected into the  (USB) port.	<ul style="list-style-type: none"> • The USB device is being connected backwards. Connect the USB device in the correct orientation.
The USB device which has been used on another device does not work.	<ul style="list-style-type: none"> • It may be recorded in an unsupported format. If so, first take the precaution of backing up important files on the USB device by copying them to your computer hard disk. Next, format the USB device in FAT12, FAT16, or FAT32 format, and transfer the files to the USB device again.* * This system supports FAT12, FAT16, and FAT32, but some USB devices may not support all of these. For details, refer to the operating instructions of each USB device or contact the manufacturer.
“READING” is displayed for a long time.	<ul style="list-style-type: none"> • The reading process can take a long time in the following cases. <ul style="list-style-type: none"> – There are many folders or files on the USB device. – The file structure is extremely complex. – The memory capacity is excessive. – The internal memory is fragmented. • Sony recommends following these guidelines. <ul style="list-style-type: none"> – Total folders on the USB device: 200 or less – Total files per folder: 150 or less
File names are not displayed properly.	<ul style="list-style-type: none"> • Transfer the music data onto the USB device again, as the data stored in the USB device may have been corrupted. • The character codes that can be displayed by this system are numbers and letters only. Other characters are not displayed correctly.
“DATA ERROR” appears in the front panel display during playback of a USB device.	<ul style="list-style-type: none"> • The audio file/JPEG image file you want to play is broken. • The data is not MPEG1 Audio Layer 3 data. • The JPEG image file format does not conform to DCF. • The file has the extension “.jpg” or “.jpeg,” but is not in JPEG format. • The file you want to play has the extension “.avi” or “.divx” but is not in DivX format, or is in DivX format but does not conform to DivX Certified profiles. • The file you want to play has the extension “.mp4” or “.m4v” but is not in MP4 format, or is in MP4 format but does not conform to MPEG4 Simple Profiles.
Playback does not start.	<ul style="list-style-type: none"> • Turn off the system, then reconnect the USB device. • Connect the USB device that this system can play. See “Playable USB Devices” (supplement). • Press  to start play.
Playback does not start from the first track.	<ul style="list-style-type: none"> • Cancel Repeat Play (page 63).

Symptom	Remedy
It takes time until playback starts.	<ul style="list-style-type: none"> • The system is playing an audio file in AAC format.
The USB device (audio file/JPEG image file/video file) cannot be played back.	<ul style="list-style-type: none"> • USB devices formatted with file systems other than FAT12, FAT16, or FAT32 are unsupported.* • Files that are encrypted or protected by passwords, etc. cannot be played back. • The MP3 file does not have the extension “.mp3.” • The WMA file does not have the extension “.wma.” • The AAC file does not have the extension “.m4a.” • The DivX video file does not have the extension “.avi” or “.divx.” • The MPEG4 video file does not have the extension “.mp4” or “.m4v.” • The data is not stored in the desired format. • The MP3 files in formats other than MPEG 1 Audio Layer 3 cannot be played back. • If you use a partitioned USB device, only audio files on the first partition can be played. • The system can playback to a depth of 8 folders only. • Check the [MEDIA] setting (page 62). • The number of folders has exceeded 200. • The number of files has exceeded 150. • For audio files/JPEG image files, the folder contains more than 150 files. • The JPEG image file does not have the extension “.jpg” or “.jpeg.” • The JPEG image file is larger than 3,072 (width) × 2,048 (height) in normal mode, or more than 2,000,000 pixels in progressive JPEG mode which is mainly used on Internet Web sites. • JPEG image files with a high width to length ratio cannot be played back. • The system cannot play audio tracks in MP3PRO format. • A WMA file that is in WMA DRM, WMA Lossless, or WMA PRO format cannot be played back. • An AAC file that is in AAC DRM or AAC Lossless format cannot be played back. <p>* This system supports FAT12, FAT16, and FAT32, but some USB devices may not support all of these. For details, refer to the operating instructions of each USB device or contact the manufacturer.</p>
Audio files or JPEG image files take longer to play back than others.	<ul style="list-style-type: none"> • After the system reads all files on the USB device, playback may take more time than usual if: <ul style="list-style-type: none"> – the number of folders or files is very large. – the folder or file organization structure is very complex. – the memory capacity is very large. – the file size is extremely large. – the physical structure within the memory is fragmented. • Sony recommends following these guidelines. <ul style="list-style-type: none"> – Total folders on the USB device: 200 or less – Total files per folder: 150 or less
You cannot start transferring onto a USB device.	<ul style="list-style-type: none"> • The following problems may have occurred. <ul style="list-style-type: none"> – The USB device is full. – The number of MP3 files and folders on the USB device has reached the upper limit. – The USB device is write-protected.

Symptom	Remedy
Transferring stops before it is finished.	<ul style="list-style-type: none"> • The communication speed of the USB device is extremely slow. Connect a USB device that this system can play. • If the transferring and erasing operations are repeated multiple times, the file structure within the USB device becomes complex. Follow the procedure in the operating instructions of the USB device to format the USB device. If the problem persists, contact your nearest Sony dealer.
Transferring to a USB device results in an error.	<ul style="list-style-type: none"> • You are using an unsupported USB device. See “Playable USB Devices” (supplement). • The USB device was disconnected or the power was turned off during transferring. The USB device may be broken. Follow the procedure in the operating instructions of the USB device to format the USB device. If the problem persists, contact your nearest Sony dealer.
Audio files or folders on the USB device cannot be erased.	<ul style="list-style-type: none"> • Check if the USB device is write-protected. • The USB device was disconnected or the power was turned off during erasing. Delete the partially-erased file. If this does not fix the problem, the USB device may be broken. Follow the procedure in the operating instructions of the USB device to format the USB device. If the problem persists, contact your nearest Sony dealer.

Self-diagnosis Function

(When letters/numbers appear in the display)

When the self-diagnosis function is activated to prevent the system from malfunctioning, a 5-character service number (e.g., C 13 50) with a combination of a letter and 4 digits appears on the TV screen or front panel display. In this case, check the following table.

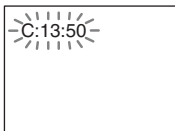

First 3 characters of the service number	Cause and/or corrective action
C 13	The disc is dirty. ➔ Clean the disc with a soft cloth (page 80).
C 31	The disc is not inserted correctly. ➔ Restart the system, then re-insert the disc correctly.
E XX (XX is a number)	To prevent a malfunction, the system has performed the self-diagnosis function. ➔ Contact your nearest Sony dealer or local authorized Sony service facility and give the 5-character service number. Example: E 61 10

When the version number appears on the TV screen

When you turn on the system, the version number [VER.X.XX] (X is a number) may appear on the TV screen. Although this is not a malfunction and for Sony service use only, normal system operation will not be possible. Turn off the system, and then turn on the system again to operate.



Specifications

Amplifier Section

Stereo mode (rated)	108 W + 108 W (at 3 ohms, 1 kHz, 1% THD)
Surround mode (reference)	RMS output power FL/FR/C/SL/SR*: 142 watts (per channel at 3 ohms, 1 kHz, 10% THD) Subwoofer*: 140 watts (at 3 ohms, 80 Hz, 10% THD)

* Depending on the decoding mode settings and the source, there may be no sound output.

Inputs (Analog)

TV (AUDIO IN) Sensitivity: 450/250 mV

AUDIO IN Sensitivity: 250/125 mV

Outputs (Analog)

Phones Accepts low- and high-impedance headphones.

Super Audio CD/DVD System

Laser Diode Properties	Emission Duration: Continuous Laser Output: Less than 44.6μW
------------------------	---

* This output is the value measurement at a distance of 200mm from the objective lens surface on the Optical Pick-up Block with 7mm aperture.

Signal format system PAL/NTSC

USB Section

↔ (USB) port:

Maximum current: 500 mA

Tuner Section

System PLL quartz-locked digital synthesizer

FM Tuner section

Tuning range

North American models: 87.5 MHz - 108.0 MHz (100 kHz step)

Other models: 87.5 MHz - 108.0 MHz (50 kHz step)

Antenna (aerial) FM wire antenna (aerial)

Antenna (aerial) terminals 75 ohms, unbalanced

Intermediate frequency 10.7 MHz

Video Section

Outputs VIDEO: 1 V_{p-p} 75 ohms
R/G/B: 0.7 V_{p-p} 75 ohms
HDMI OUT: Type A (19 pin)

Speakers

Front/Surround (SS-TS92)

Speaker system	Full range Bass reflex
Speaker unit	65 mm cone type
Rated impedance	3 ohms
Dimensions (approx.)	103 mm × 164 mm × 94 mm (w/h/d)
Mass (approx.)	0.5 kg

Center (SS-CT91)

Speaker system	Full range Bass reflex, Magnetically Shielded
Speaker unit	65 mm cone type
Rated impedance	3 ohms
Dimensions (approx.)	265 mm × 94 mm × 77 mm (w/h/d)
Mass (approx.)	0.7 kg

Subwoofer (SS-WS91)

Speaker system	Subwoofer Bass reflex
Speaker unit	160 mm cone type
Rated impedance	3 ohms
Dimensions (approx.)	168 mm × 300 mm × 325 mm (w/h/d)
Mass (approx.)	5.3 kg

General

Power requirements	220 V - 240 V AC, 50/60 Hz
Power consumption	On: 150 W Standby: 0.3 W (at the Power Saving mode)
Output voltage (DIGITAL MEDIA PORT)	DC 5 V
Output current (DIGITAL MEDIA PORT)	700 mA
Dimensions (approx.)	430 mm × 66 mm × 390 mm (w/h/d) incl. projecting parts
Mass (approx.)	4.3 kg

Supported file format

MP3 (MPEG 1 Audio Layer-3)

File Extension:	mp3
Bitrate:	32 kbps - 320 kbps
Sampling frequencies:	32/44.1/48 kHz

WMA (USB device only)

File Extension:	wma
Bitrate:	48 kbps - 192 kbps
Sampling frequencies:	44.1 kHz

AAC (USB device only)

File Extension:	m4a
Bitrate:	48 kbps - 320 kbps
Sampling frequencies:	44.1 kHz

DivX

File Extension:	avi/divx
Video codec:	DivX video
Bitrate:	8 Mbps (MAX)
Frame rate:	30 fps
Resolution:	720 × 576
Audio codec:	MP3

MPEG4

File format:	MP4 File Format
File Extension:	mp4/m4v
Video codec:	MPEG4 Simple Profile (AVC is not compatible.)
Bitrate:	4 Mbps
Frame rate:	30 fps
Resolution:	720 × 576
Audio codec:	AAC-LC (HE-AAC is not compatible.)
DRM:	Not compatible

Design and specifications are subject to change without notice.

Glossary

Dolby Digital

This movie theater sound format is more advanced than Dolby Surround Pro Logic. In this format, the surround speakers output stereo sound with an expanded frequency range, and a subwoofer channel for deep bass is independently provided. This format is also called “5.1” with the subwoofer channel designed as the 0.1 channel (since it functions only when a deep bass effect is needed). All six channels in this format are recorded separately for superior channel separation. Furthermore, since all the signals are processed digitally, less signal degradation occurs.

Dolby Pro Logic II

Dolby Pro Logic II creates five full-bandwidth output channels from 2 channel sources. This is done using an advanced, high-purity matrix surround decoder that extracts the spatial properties of the original recording without adding any new sounds or tonal colorations.

■ Movie mode

The Movie mode is for use with stereo television shows and all programs encoded in Dolby Surround. The result is enhanced sound field directionality that approaches the quality of discrete 5.1-channel sound.

■ Music mode

The Music mode is for use with any stereo music recordings, and provides a wide and deep sound space.

Dolby Surround Pro Logic

As one method of decoding Dolby Surround, Dolby Surround Pro Logic produces four channels from 2 channel sound. Compared with the former Dolby Surround system, Dolby Surround Pro Logic reproduces left-to-right panning more naturally and localizes sounds more precisely. To take full advantage of Dolby Surround Pro Logic, you should have one pair of surround speakers and a center speaker. The surround speakers output monaural sound.

DTS

Digital audio compression technology developed by DTS, Inc. This technology

conforms to 5.1-channel surround. This format is comprised of a stereo rear channel and a discrete subwoofer channel. DTS provides the same 5.1 discrete channels of high quality digital audio. The good channel separation is realized due to the all channel data being recorded discretely and processed digitally.

HDMI (High-Definition Multimedia Interface)

HDMI is an interface that supports both video and audio on a single digital connection, allowing you to enjoy high quality digital picture and sound. The HDMI specification supports HDCP (High-bandwidth Digital Content Protection), a copy protection technology that incorporates coding technology for digital video signals.

Parental Control

A function of the DVD to limit playback of the disc by the age of users according to the limitation level in each country. The limitation varies from disc to disc; when it is activated, playback is completely prohibited, violent scenes are skipped or replaced with other scenes and so on.

Super Audio CD

Super Audio CD is a new high-quality audio disc standard where music is recorded in the DSD (Direct Stream Digital) format (conventional CD is recorded in the PCM format). The DSD format, using a sampling frequency 64 times higher than that of a conventional CD, and with 1-bit quantization, achieves both a wide frequency range and a wide dynamic range across the audible frequency range, and so provides music reproduction extremely faithful to the original sound.

■ Super Audio CD types

There are two types of discs, depending on the Super Audio CD layer and CD layer combination.

- Super Audio CD layer: A high-density signal layer for Super Audio CD
- CD layer¹⁾: A layer that is readable by a conventional CD player

Single layer disc
(a disc with a single Super Audio CD layer)

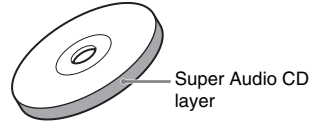

Hybrid disc²⁾
(a disc with a Super Audio CD layer and a CD layer)

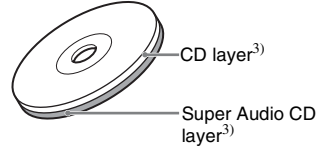

A Super Audio CD layer consists of the 2 channel area or the multi-channel area.

- 2 channel area: An area in which 2 channel stereo tracks are recorded
- Multi-channel area: An area in which multi-channel (up to 5.1 channels) tracks are recorded

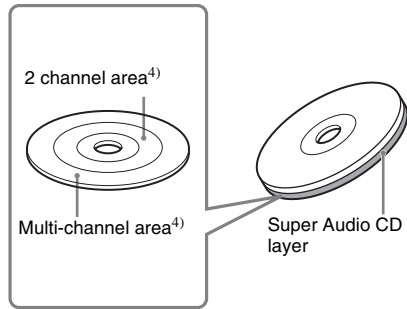

¹⁾You can play the CD layer on a conventional CD player.

²⁾Since both layers are on one side, it is not necessary to turn the disc over.

³⁾To select a layer, see “Changing a playback layer for a hybrid Super Audio CD” (page 30).

⁴⁾To select an area, see “Selecting a playback area for a Super Audio CD” (page 30).

Playback priority of file types

The table below describes the playback priority of file types under the [MEDIA] setting.

File type on a disc or USB device	[MEDIA] setting				
	[VIDEO]		[MUSIC/PHOTO]	[PHOTO]	[MUSIC]
	Disc	USB device	Disc	Disc/USB device	Disc/USB device
Video files only	Video files	Video files	Video files	Video files	Video files
JPEG image files only	JPEG image files	JPEG image files	JPEG image files	JPEG image files	JPEG image files
Audio files only	Audio files	Audio files	Audio files	Audio files	Audio files
Video files and JPEG image files	Video files	Video files	JPEG image files	JPEG image files	Video files
Video files and audio files	Video files	Video files	Audio files	Audio files	Audio files
Audio files and JPEG image files	Audio files and JPEG image files with slide show	Audio files	Audio files and JPEG image files with slide show	JPEG image files	Audio files
Video files, audio files, and JPEG image files	Video files	Video files	Audio files and JPEG image files with slide show	JPEG image files	Audio files

Language Code List

The language spellings conform to the ISO 639: 1988 (E/F) standard.

Code Language	Code Language	Code Language	Code Language
1027 Afar	1183 Irish	1347 Maori	1507 Samoan
1028 Abkhazian	1186 Scots Gaelic	1349 Macedonian	1508 Shona
1032 Afrikaans	1194 Galician	1350 Malayalam	1509 Somali
1039 Amharic	1196 Guarani	1352 Mongolian	1511 Albanian
1044 Arabic	1203 Gujarati	1353 Moldavian	1512 Serbian
1045 Assamese	1209 Hausa	1356 Marathi	1513 Siswati
1051 Aymara	1217 Hindi	1357 Malay	1514 Sesotho
1052 Azerbaijani	1226 Croatian	1358 Maltese	1515 Sundanese
1053 Bashkir	1229 Hungarian	1363 Burmese	1516 Swedish
1057 Byelorussian	1233 Armenian	1365 Nauru	1517 Swahili
1059 Bulgarian	1235 Interlingua	1369 Nepali	1521 Tamil
1060 Bihari	1239 Interlingue	1376 Dutch	1525 Telugu
1061 Bislama	1245 Inupiak	1379 Norwegian	1527 Tajik
1066 Bengali; Bangla	1248 Indonesian	1393 Occitan	1528 Thai
1067 Tibetan	1253 Icelandic	1403 (Afan)Oromo	1529 Tigrinya
1070 Breton	1254 Italian	1408 Oriya	1531 Turkmen
1079 Catalan	1257 Hebrew	1417 Punjabi	1532 Tagalog
1093 Corsican	1261 Japanese	1428 Polish	1534 Setswana
1099 Czech	1269 Yiddish	1435 Pashto;	1535 Tonga
1103 Welsh	1283 Javanese	Pushto	1538 Turkish
1105 Danish	1287 Georgian	1436 Portuguese	1539 Tsonga
1109 German	1297 Kazakh	1463 Quechua	1540 Tatar
1130 Bhutani	1298 Greenlandic	1481 Rhaeto-	1543 Twi
1142 Greek	1299 Cambodian	Romance	1557 Ukrainian
1144 English	1300 Kannada	1482 Kirundi	1564 Urdu
1145 Esperanto	1301 Korean	1483 Romanian	1572 Uzbek
1149 Spanish	1305 Kashmiri	1489 Russian	1581 Vietnamese
1150 Estonian	1307 Kurdish	1491 Kinyarwanda	1587 Volapük
1151 Basque	1311 Kirghiz	1495 Sanskrit	1613 Wolof
1157 Persian	1313 Latin	1498 Sindhi	1632 Xhosa
1165 Finnish	1326 Lingala	1501 Sangho	1665 Yoruba
1166 Fiji	1327 Laothian	1502 Serbo-	1684 Chinese
1171 Faroese	1332 Lithuanian	Croatian	1697 Zulu
1174 French	1334 Latvian;	1503 Singhalese	
1181 Frisian	Lettish	1505 Slovak	
	1345 Malagasy	1506 Slovenian	1703 Not specified

Parental Control Area Code List

Code Area	Code Area	Code Area	Code Area
2044 Argentina	2165 Finland	2362 Mexico	2149 Spain
2047 Australia	2174 France	2376 Netherlands	2499 Sweden
2046 Austria	2109 Germany	2390 New Zealand	2086 Switzerland
2057 Belgium	2248 India	2379 Norway	2528 Thailand
2070 Brazil	2238 Indonesia	2427 Pakistan	2184 United Kingdom
2079 Canada	2254 Italy	2424 Philippines	
2090 Chile	2276 Japan	2436 Portugal	
2092 China	2304 Korea	2489 Russia	
2115 Denmark	2363 Malaysia	2501 Singapore	

Index to Parts and Control

For more information, refer to the pages indicated in parentheses.

Front panel

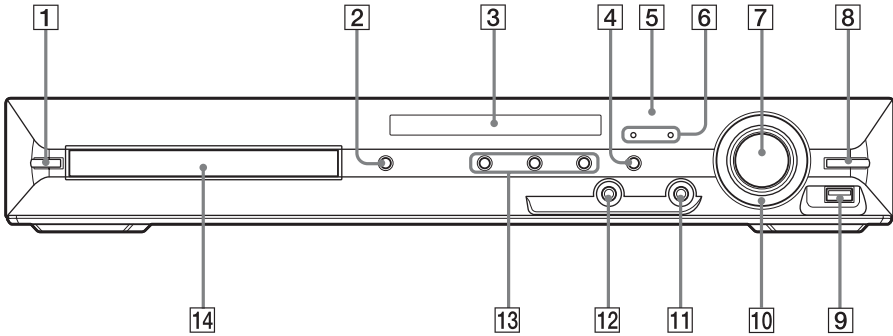

1 I/O (on/standby) (21, 78)

2 ▲ (open/close) (27)

3 Front panel display (97)

4 FUNCTION (23)

5 (remote sensor) (10)

6 MOVIE/MUSIC indicator (73)

7 VOLUME control (27)

8 REC TO USB (67)

9 (USB) port (58)

10 OPERATION DIAL (27)

11 PHONES jack (27)

12 AUDIO IN jack (17)

13 Play operation buttons (27)

14 Disc tray (27)

Rear panel

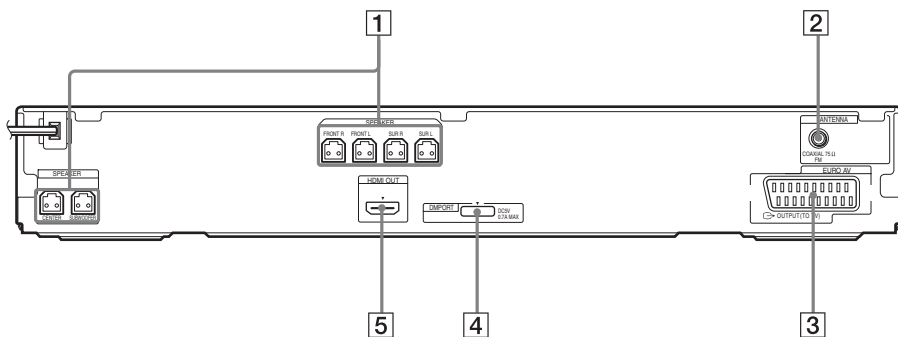

1 **SPEAKER** jacks (15)

2 **COAXIAL 75Ω FM** jack (19)

3 **EURO AV**  **OUTPUT (TO TV)** jack (16)

4 **DMPORTR (DIGITAL MEDIA PORT)** jack (17, 69)

5 **HDMI OUT** jack (16)

Front panel display

About the indications in the front panel display

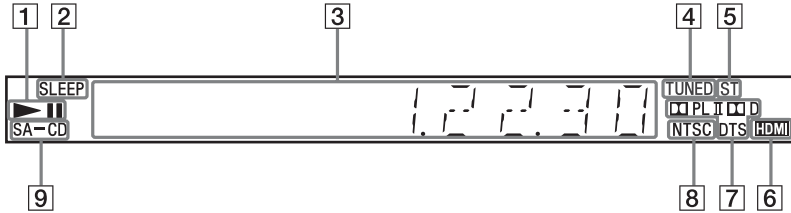

- 1 Playing status
- 2 Flashes when the sleep timer is set. (74)
- 3 Displays the system's status such as chapter, title, or track number, time information, radio frequency, playing status, decoding mode, etc.
- 4 Lights up when a station is received. (Radio only) (52)
- 5 Stereo/Monaural effect (Radio only) (53)
- 6 Lights up when the HDMI OUT jack is correctly connected to HDCP (High-bandwidth Digital Content Protection) compliant device with HDMI or DVI (Digital Visual Interface) input. (16)
- 7 Current surround format (Except for JPEG image file)
- 8 Lights up when an NTSC disc is loaded.
- 9 Lights up when a Super Audio CD/CD is loaded. (30)

Remote control

ALPHABETICAL ORDER		BUTTON DESCRIPTIONS
A - O	P - Z	
ANGLE 22 (28)	PICTURE NAVI 34 (38, 60)	Number buttons 14 (31, 52, 72)
AUDIO 15 (29)	PRESET +/- 27 (53)	⏻ (on/standby) 1 (20, 21, 27)
CLEAR 32 (32, 53)	PROG +/- 27 (72)	TV ⏻ (on/standby) 19 (72)
D.TUNING 16 (53)	S-AIR MODE ²⁾ 35	⏪/⏩/⏴/⏵ ⊕ 12 (20, 21, 30, 32, 52, 71)
DIMMER 33 (75)	SLEEP 17 (74)	⏮ +/- 6 (37, 57)
DISPLAY 21 (54, 64, 75)	SOUND MODE 3 (73)	⏮•••⏭ REPLAY/ADVANCE 9 (27)
DVD MENU 25 (35)	SUBTITLE 16 (28)	⏮⏪/⏩⏭ 27 (27)
DVD TOP MENU 13 (35)	SYSTEM MENU 5 (20, 24, 52, 74)	⏮⏪/⏩⏭ 10 (27)
DYNAMIC BASS 4 (72)	THEATRE 18 (55)	STEP ⏮ ⏭ 9 (27)
ENTER 24 (72)	TOOLS 26 (72)	SLOW ⏮ ⏭ 10 (27)
FUNCTION +/- 2 (23, 27)	TUNING +/- 10 (52)	▷ (play) 30 (27)
MEMORY SELECT ¹⁾ 22	TV 29 (72)	■ (stop) 28 (27)
MENU 25 (72)	TV INPUT 20 (72)	⏸ (pause) 11 (27)
MUTING 7 (27)	VOLUME +/- 8 (27)	⏻ DISPLAY ³⁾ 26 (21, 30, 32, 45, 71, 99)
NIGHT 23 (72)		↻ RETURN 31 (31, 72)
ONE-TOUCH PLAY 36 (56)		-/- 32 (72)

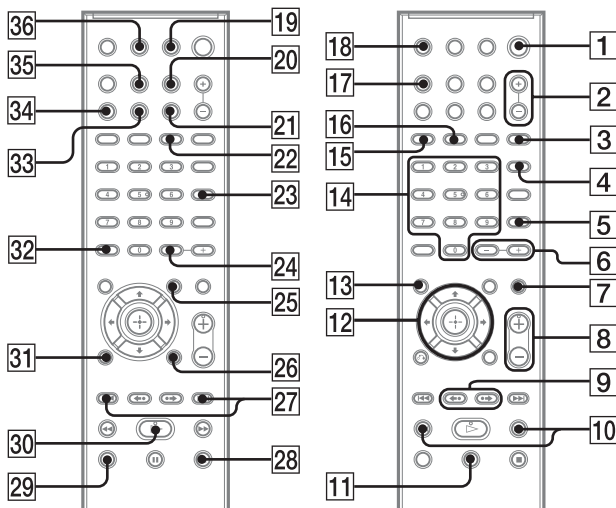

¹⁾See the included supplement.

²⁾This button is not available for this model.

³⁾This button is available for the "DVD," "USB," or "DMPORT" function. Depending on the DIGITAL MEDIA PORT adapter, this button may not work.

Guide to the Control Menu Display

You can use the Control Menu display to select a function and to view related information.

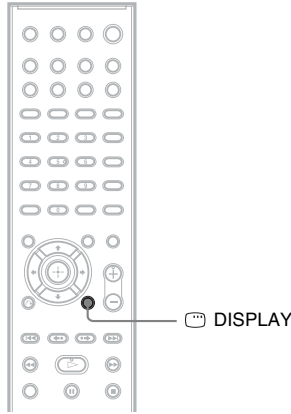

Press DISPLAY repeatedly.

Each time you press DISPLAY, the Control Menu display changes:

① → ② → ... → ① → ...

- ① Control Menu display 1
- ② Control Menu display 2 (appears when available)
- ③ Control Menu display off

Note

• The Control Menu Display appears during the “DVD” or “USB” function.

Control Menu display

The Control Menu display 1 and 2 will show different items depending on the disc type. For details, see the pages in parentheses.

Example: Control Menu display 1 when playing a DVD VIDEO.

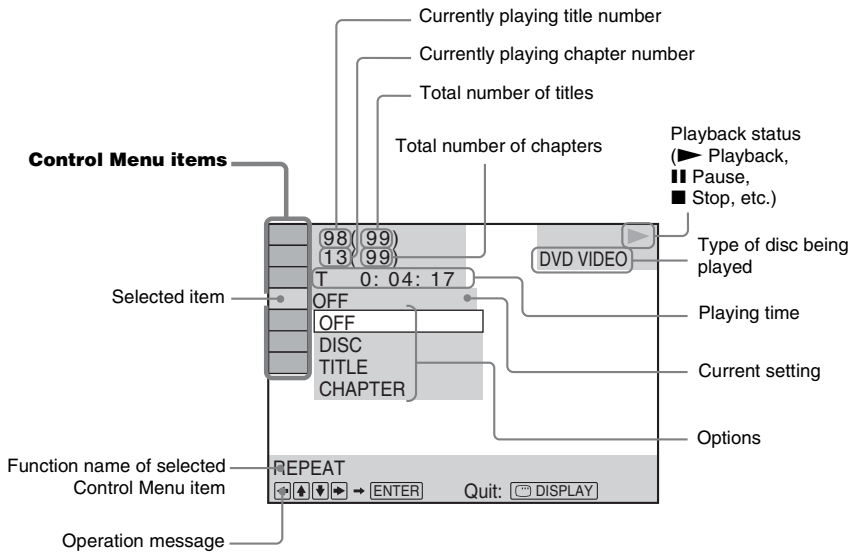













To turn off the display

Press DISPLAY.





List of Control Menu items









Item	Item Name, Function, Relevant Disc Type
	[TITLE] (page 35)/[SCENE] (page 35)/[TRACK] (page 35) You can select the title, scene, or track to be played. DVD-V DVD-VR VIDEO CD
	[CHAPTER] (page 35)/[INDEX] (page 35) You can select the chapter or index to be played. DVD-V DVD-VR VIDEO CD
	[INDEX] (page 35) You can display the index and select the index to be played. Super Audio CD
	[TRACK] (page 35) You can select the track to be played. CD DATA-CD DATA DVD Super Audio CD
	[ORIGINAL/PLAY LIST] (page 35) You can select the type of titles (DVD-RW/DVD-R) to be played, the [ORIGINAL] one, or an edited [PLAY LIST]. DVD-VR
	[TIME] (page 36) You can check the elapsed time and the remaining playback time. You can play from a desired point by inputting the time code (DVD VIDEO/DVD-VR only). DVD-V DVD-VR VIDEO CD CD DATA-CD DATA DVD Super Audio CD
	[MULTI/2CH] (page 30) You can select the playback area on a Super Audio CD when available. Super Audio CD
	[SUPER AUDIO CD/CD LAYER] (page 30) You can select the playback layer on a Super Audio CD when available. Super Audio CD
	[PROGRAM] (page 32) You can select the track to play in the order you want. VIDEO CD CD

	<p>[SHUFFLE] (page 33) You can play the tracks/files in random order.</p> <p style="text-align: right;">VIDEO CD C D DATA-CD DATA DVD Super Audio CD</p>
	<p>[REPEAT] (page 34) You can play the entire disc (all titles/all tracks/all folders/all files) repeatedly or one title/ chapter/track/folder/file repeatedly.</p> <p style="text-align: right;">DVD-V DVD-VR VIDEO CD C D DATA-CD DATA DVD Super Audio CD</p>
	<p>[A/V SYNC] (page 43) You can adjust the delay between the picture and sound.</p> <p style="text-align: right;">DVD-V DVD-VR VIDEO CD DATA-CD DATA DVD</p>
	<p>[DISC MENU] (page 35) You can display the DVD's menu.</p> <p style="text-align: right;">DVD-V</p>
	<p>[BROWSING] (page 40) You can display the list of folders/JPEG image files.</p> <p style="text-align: right;">DATA-CD DATA DVD</p>
	<p>[SETUP] (page 45) [QUICK] (page 21) You can make the basic adjustments. Use Quick Setup to select the desired language of the on-screen display, the aspect ratio of the TV, and select yes or no to start the Auto Calibration. [CUSTOM] In addition to the Quick Setup setting, you can adjust various other settings.</p> <p style="text-align: right;">DVD-V DVD-VR VIDEO CD C D DATA-CD DATA DVD Super Audio CD</p>
	<p>[FOLDER] (page 35) You can select the folder to be played.</p> <p style="text-align: right;">DATA-CD DATA DVD</p>
	<p>[FILE] (page 35) You can select the JPEG image file or video file to be played.</p> <p style="text-align: right;">DATA-CD DATA DVD</p>
 *	<p>[DATE] (page 77) You can display the date the picture was taken by a digital camera.</p> <p style="text-align: right;">DATA-CD DATA DVD</p>
 *	<p>[INTERVAL] (page 39) You can select the duration for which the slides are displayed on the TV screen.</p> <p style="text-align: right;">DATA-CD DATA DVD</p>
 *	<p>[EFFECT] (page 40) You can select the effects to be used for changing slides during a slide show.</p> <p style="text-align: right;">DATA-CD DATA DVD</p>
	<p>[MEDIA] (page 40) You can select the data type (MP3 file, JPEG image file, video file, or both MP3 file and JPEG image file) to be played on a DATA CD/DATA DVD.</p> <p style="text-align: right;">DATA-CD DATA DVD</p>



* These items are not displayed when playing a DATA CD/DATA DVD with video files.

List of Control Menu Items for USB device

Item	Item Name, Function, Relevant Disc Type
	<p>[REPEAT] (page 63) You can play the entire USB device (all folders/all files) repeatedly or one folder/file repeatedly.</p>
	<p>[BROWSING] (page 63) You can display the list of folders/JPEG image files.</p>
	<p>[DATE] (page 65) You can display the date the picture was taken by a digital camera.</p>
	<p>[INTERVAL] (page 61) You can select the duration for which the slides are displayed on the TV screen.</p>

	[EFFECT] (page 61) You can select the effects to be used for changing slides during a slide show.
	[MEDIA] (page 62) You can select the data type (MP3/AAC/WMA file, JPEG image file, or video file) on a USB device.
	[USB TRANSFER] (page 65) You can transfer tracks on an audio CD or MP3 files on a CD/DATA CD/DATA DVD onto a USB device.
	[SHUFFLE] You can play files in random order.
	[TRACK] You can select the track to be played.
	[FOLDER] You can select the folder to be played.
	[FILE] You can select the JPEG image file to be played.
	[TIME] You can check the elapsed time and the remaining playback time.
	[A/V SYNC] You can adjust the delay between the picture and sound.

Tip

- The Control Menu icon indicator lights up in yellow  →  when you select any item except [OFF] ([PROGRAM], [SHUFFLE], [REPEAT], and [A/V SYNC] only). The [ORIGINAL/PLAY LIST] indicator lights up in yellow when you select [PLAY LIST] (default setting). The [MULTI/2CH] indicator lights up in yellow when you select the multi-channel playback area on a Super Audio CD.

Index

Numerics

5.1 Channel Surround 29

A

A/V SYNC 43
AAC file 57
ANGLE 28
ATTENUATE 74
AUDIO 46
AUDIO (HDMI) 48
AUDIO DRC 49
Audio file 57
AUDIO SETUP 49

B

BACKGROUND 49

C

COLD RESET 78
CONTROL FOR HDMI 47
Control for HDMI 55
Control Menu Display 99
CUSTOM 45, 78

D

DATA CD 41
DATA DVD 41
DEMO 20
DIGITAL MEDIA PORT 69
DIMMER 75
DISPLAY 54
DivX 57
DivX® 41, 50
Dolby Digital 29, 91
Dolby Pro Logic II 91
Dolby Surround Pro Logic 91
DTS 29, 91
DVD's menu 35
DYNAMIC BASS 72

E

EFFECT 40, 61

F

FM MODE 53
Front panel 95
Front panel display 75, 97

H

HDMI
YCBCR/RGB (HDMI) 48
HDMI (High-Definition
Multimedia Interface) 92
HDMI RESOLUTION 47
HDMI SETUP 47

I

Instant Advance 28
Instant Replay 28
INTERVAL 39, 61

J

JPEG image file 37, 57
JPEG RESOLUTION 48

L

Language Code List 94
LANGUAGE SETUP 46
LINE 47

M

MEDIA 37, 38, 39, 40, 41, 59,
60, 62, 63
MENU 46
MP3 file 37, 57
MPEG4 57
Multi Session CD 7
MULTI-DISC RESUME 50

N

Naming preset stations 53
NIGHT 72

O

OSD 46

P

PARENTAL CONTROL 43,
49, 92
PAUSE MODE 47
PBC Playback 31
PICTURE NAVI 38, 60
Playable discs 6
Program Play 32

Q

Quick Setup 21

R

RDS 54
Rear panel 96
Region Code 8
Remote 10
Repeat Play 34
RESET 50, 78
Resume Play 31

S

SCREEN SAVER 49
SETUP 45, 78
Shuffle Play 33
SLEEP 74
Slide Show 39
SPEAKER FORMATION 49,
71
SPEAKER SETUP 50
CONNECTION 50
DISTANCE 50
LEVEL 51
SUBTITLE 29, 46
Super Audio CD 30, 92
SYSTEM MENU 20, 24, 53,
74, 75
SYSTEM SETUP 49

T

TEST TONE 51
TIME 36
TRACK SELECTION 49
TV TYPE 47

U

USB device 57

V

VIDEO SETUP 46
VOLUME LIMIT 48

W

WMA file 57



* 4 1 2 2 2 2 0 1 1 * (1)