

SHARP®

LC-42B20E
LC-42B20S

LC-42G20E
LC-42G20S

LCD COLOUR TELEVISION
LCD-FARBFERNSEHGERÄT
TÉLÉVISEUR COULEUR À ÉCRAN
CRISTAUX LIQUIDES (LCD)
TELEVISORE A COLORI LCD
LCD-KLEURENTELEVISIE
TELEVISIÓN EN COLOR LCD

AQUOS



OPERATION MANUAL
BEDIENUNGSANLEITUNG
MODE D'EMPLOI
MANUALE DI ISTRUZIONI
GEBRUIKSAANWIJZING
MANUAL DE MANEJO

HDMI™
HIGH-DEFINITION MULTIMEDIA INTERFACE

DVB
Digital Video
Broadcasting

HD
ready
1080p

DOLBY
DIGITAL

SRS
TruSurround XT

ENGLISH

DEUTSCH

FRANÇAIS



ITALIANO

NEDERLANDS

ESPAÑOL



SPECIAL NOTE FOR USERS IN THE U.K.

The mains lead of this product is fitted with a non-rewireable (moulded) plug incorporating a 13A fuse. Should the fuse need to be replaced, a BSI or ASTA approved BS 1362 fuse marked  or  and of the same rating as above, which is also indicated on the pin face of the plug, must be used.

Always refit the fuse cover after replacing the fuse. Never use the plug without the fuse cover fitted.

In the unlikely event of the socket outlet in your home not being compatible with the plug supplied, cut off the mains plug and fit an appropriate type.

DANGER:

The fuse from the cut-off plug should be removed and the cut-off plug destroyed immediately and disposed of in a safe manner.

Under no circumstances should the cut-off plug be inserted elsewhere into a 13A socket outlet, as a serious electric shock may occur.

To fit an appropriate plug to the mains lead, follow the instructions below:

IMPORTANT:

The wires in the mains lead are coloured in accordance with the following code:

Blue: Neutral

Brown: Live

As the colours of the wires in the mains lead of this product may not correspond with the coloured markings identifying the terminals in your plug, proceed as follows:

- The wire which is coloured blue must be connected to the plug terminal which is marked N or coloured black.
- The wire which is coloured brown must be connected to the plug terminal which is marked L or coloured red.

Ensure that neither the brown nor the blue wire is connected to the earth terminal in your three-pin plug.

Before replacing the plug cover make sure that:

- If the new fitted plug contains a fuse, its value is the same as that removed from the cut-off plug.
- The cord grip is clamped over the sheath of the mains lead, and not simply over the lead wires.

IF YOU HAVE ANY DOUBT, CONSULT A QUALIFIED ELECTRICIAN.

- The illustrations and on-screen displays in this operation manual are for explanation purposes and may vary slightly from the actual operations.

Contents

Contents	1	Basic adjustment	24
Introduction	2	Picture Settings.....	24
Dear SHARP customer	2	AV Mode.....	25
Important Safety Precautions	2	Audio Settings	25
Trademarks.....	2	Power Save Settings.....	25
Remote control unit.....	3	Channel Settings.....	26
TV (Front view)	4	Auto Installation	26
TV (Rear view).....	4	Digital channel settings	26
Preparation	5	Analogue channel settings	27
Supplied accessories	5	Password/Parental lock settings	28
Attaching the stand unit	5	Language Settings (language, subtitle, multi audio)	28
Inserting the batteries.....	6	Useful Viewing functions	29
Using the remote control unit	6	Selecting the WSS picture size automatically	29
Cautions regarding the remote control unit.....	6	Selecting the WSS picture size manually	29
Quick guide	7	Selecting the picture size manually	29
Initial installation overview.....	7	Selecting the recording picture size manually	30
Before turning on the power.....	8	Selecting the HDMI picture size automatically	30
Bundling the cables	8	Other Picture and audio settings	30
Initial auto installation	9	Adjusting image position	30
Checking signal strength and channel strength	9	Reducing noise on the screen.....	30
Watching TV	10	Automatic volume adjustment.....	30
Daily operation	10	Clear Voice	30
Switching on/off.....	10	Audio Only	30
Switching between analogue and digital broadcasts	10	Display Settings	31
Changing channels	10	Channel display	31
Selecting external video source.....	10	Time and Title display	31
Selecting Sound mode	10	Other useful features	32
EPG (Electronic Programme Guide).....	11	Setting when using external devices	32
EPG Overview.....	11	Input source settings	32
Useful settings for using EPG.....	11	Skipping specified input	32
Selecting a programme using EPG.....	12	Colour system settings	32
Timer recording using EPG	13	Additional features	32
Cancelling the timer recording.....	13	Connecting a PC	33
Teletext	14	Connecting a PC	33
Using the MHEG5 application (UK only)	14	Displaying a PC image on the screen.....	33
Connecting external devices	15	Selecting the picture size	33
Introduction to connections.....	15	Adjusting the PC image automatically	34
HDMI connection	16	Adjusting the PC image manually	34
Component connection	16	Selecting input resolution	34
S-VIDEO/VIDEO connection	16	RS-232C port specifications	35
SCART connection	17	PC compatibility chart	36
Controlling devices with SCART using AV Link	17	RS-232C command list.....	36
Speaker/amplifier connection.....	18	Appendix	37
Inserting a CA Card.....	19	Troubleshooting.....	37
AQUOS LINK	20	Updating your TV via DVB-T	38
Controlling HDMI devices using AQUOS LINK.....	20	Reset	38
AQUOS LINK connection.....	21	Identification.....	38
AQUOS LINK Setup	21	Specifications	39
Operating an AQUOS LINK device	22	Optional accessory	39
Menu operation	23	End of life disposal	40
What is the Menu?	23		
Common operations	23		

Introduction

Dear SHARP customer

Thank you for your purchase of the SHARP LCD colour TV product. To ensure safety and many years of trouble-free operation of your product, please read the Important Safety Precautions carefully before using this product.

Important Safety Precautions

- Cleaning—Unplug the AC cord from the AC outlet before cleaning the product. Use a damp cloth to clean the product. Do not use liquid cleaners or aerosol cleaners.
- Water and moisture—Do not use the product near water, such as bathtub, washbasin, kitchen sink, laundry tub, swimming pool and in a wet basement.
- Do not place vases or any other water-filled containers on this product. The water may spill onto the product causing fire or electric shock.
- Stand—Do not place the product on an unstable cart, stand, tripod or table. Doing so can cause the product to fall, resulting in serious personal injuries as well as damage to the product. Use only a cart, stand, tripod, bracket or table recommended by the manufacturer or sold with the product. When mounting the product on a wall, be sure to follow the manufacturer's instructions. Use only the mounting hardware recommended by the manufacturer.
- When relocating the product placed on a cart, it must be moved with utmost care. Sudden stops, excessive force and uneven floor surface can cause the product to fall from the cart.
- Ventilation—The vents and other openings in the cabinet are designed for ventilation. Do not cover or block these vents and openings since insufficient ventilation can cause overheating and/or shorten the life of the product. Do not place the product on a bed, sofa, rug or other similar surface, since they can block ventilation openings. This product is not designed for built-in installation; do not place the product in an enclosed place such as a bookcase or rack, unless proper ventilation is provided or the manufacturer's instructions are followed.
- The LCD panel used in this product is made of glass. Therefore, it can break when the product is dropped or impact applied. If the LCD panel is broken, be careful not to be injured by broken glass.
- Heat sources—Keep the product away from heat sources such as radiators, heaters, stoves and other heat-generating products (including amplifiers).
- To prevent fire, never place any type of candle or naked flames on the top or near the TV set.
- To prevent fire or shock hazard, do not place the AC cord under the TV set or other heavy items.
- Do not display a still picture for a long time, as this could cause an afterimage to remain.
- There is power consumption always if main plug is connected.
- Servicing—Do not attempt to service the product yourself. Removing covers can expose you to high voltage and other dangerous conditions. Request a qualified person to perform servicing.

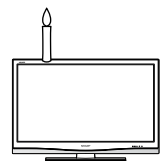

The LCD panel is a very high technology product, giving you fine picture details. Due to the very large number of pixels, occasionally a few non-active pixels may appear on the screen as a fixed point of blue, green or red. This is within product specifications and does not constitute a fault.

Precautions when transporting the TV

When transporting the TV, never carry it by holding onto the speakers. Be sure to always carry the TV by two people holding it with two hands — one hand on each side of the TV.

Trademarks

- "HDMI, the HDMI logo and High-Definition Multimedia Interface are trademarks or registered trademarks of HDMI Licensing LLC."



- Manufactured under license from Dolby Laboratories.
- "Dolby" and the double-D symbol are trademarks of Dolby Laboratories.

- TruSurround XT, SRS and (●) symbol are trademarks of SRS Labs, Inc.

- The "HD ready 1080P" Logo is a trademark of EICTA.

- The DVB logo is the registered trademark of the Digital Video Broadcasting - DVB - project.

Remote control unit

- 1 **(Standby/On)** (Page 10)
- 2 **Buttons for useful operations**
 - (Teletext)**
ATV: Display analogue teletext. (Page 14)
DTV: Select MHEG-5 and teletext for DTV. (Page 14)
 - (Reveal hidden Teletext)** (Page 14)
 - (Subtitle)**
ATV/DTV/External: Switch subtitle languages on/off. (Pages 14 and 28)
 - (Freeze/Hold)**
Press to freeze a moving image on the screen.
TELETEXT: Stop updating Teletext pages automatically or release the hold mode.
 - (Subpage)** (Page 14)
 - (Top/Bottom/Full)**
Set the area of magnification in teletext mode. (Page 14)
- 3 **0 - 9 numeric buttons**
Set the channel.
Enter desired numbers.
Set the page in teletext mode.
- 4 **(Flashback)**
Press to return to the previous image in normal viewing mode.
- 5 **DTV**
Press to access DTV mode.
- 6 **ATV**
Press to access conventional analogue TV mode.
- 7 **(Sound mode)**
Select the sound multiplex mode. (Page 10)
- 8 **(+ / -) (Volume)**
Increase/decrease TV volume.
- 9 **(Mute)**
TV sound on/off
- 10 **(WIDE MODE)**
Select the wide mode. (Pages 29 and 33)
- 11 **AV MODE**
Select a video setting. (Page 25)
- 12 **(Cursor)**
Select a desired item on the setting screen.
OK
Execute a command within the menu screen.
ATV/DTV: Display the programme list when no other menu screen is running.
- 13 **END**
Exit the menu screen.
- 14 **R/G/Y/B (Colour) buttons**
On the menu screen, the coloured buttons are correspondingly used to select the coloured items on the screen. (e.g. EPG, MHEG-5, TELETEXT)

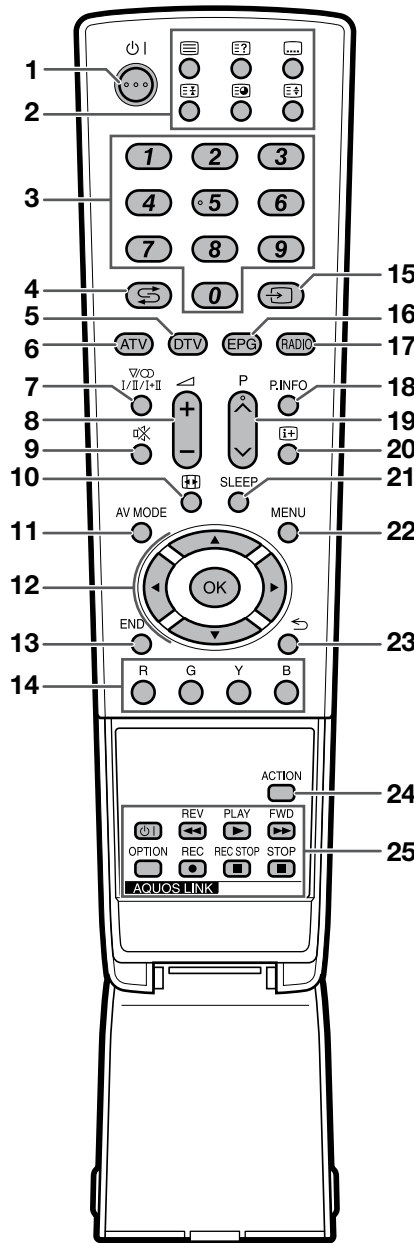

- 15 **(INPUT SOURCE)**
Select an input source. (TV, EXT1, EXT2, EXT3, EXT4, EXT5, EXT6, EXT7, EXT8) (Page 10)
- 16 **EPG**
DTV: Display the EPG screen. (Pages 11 - 13)
- 17 **RADIO**
DTV: Switch between Radio and Data mode.
• When only data broadcasting (no radio broadcasting) is transmitted by DVB, the radio broadcasting will be skipped.
- 18 **P. INFO**
Press to display programme information which is transmitted through digital video broadcasting in the upper left corner of the screen. (DTV only)
- 19 **P (▲/▼)**
Select the TV channel.
- 20 **(Display information)**
Press to display the station information (channel number, signal, etc.) in the upper right corner of the screen. (Page 31)
- 21 **SLEEP**
Press to schedule a time for the TV to automatically standby. (Page 26)
- 22 **MENU**
ATV/DTV: Menu screen on/off.
- 23 **(Return)**
Return to the previous menu screen.
- 24 **ACTION (Action Mode)**
Action Mode on/off. (Page 24)
- 25 **AQUOS LINK buttons**
If external equipment such as an AQUOS BD Player is connected via HDMI cables and is AQUOS LINK compatible, you can use these AQUOS LINK buttons. See pages 20 and 22 for details.

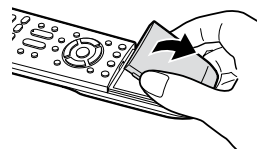

Introduction

TV (Front view)

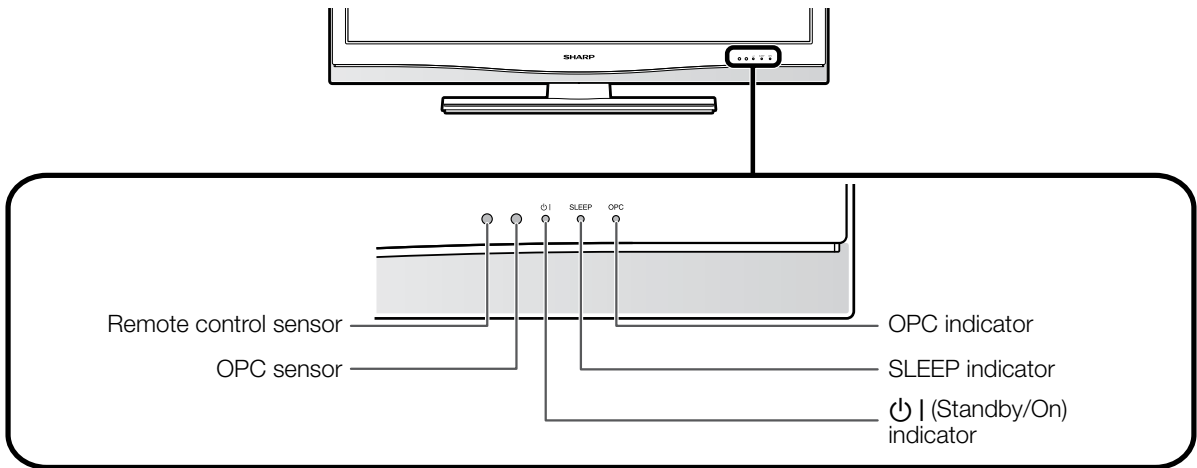

TV (Rear view)

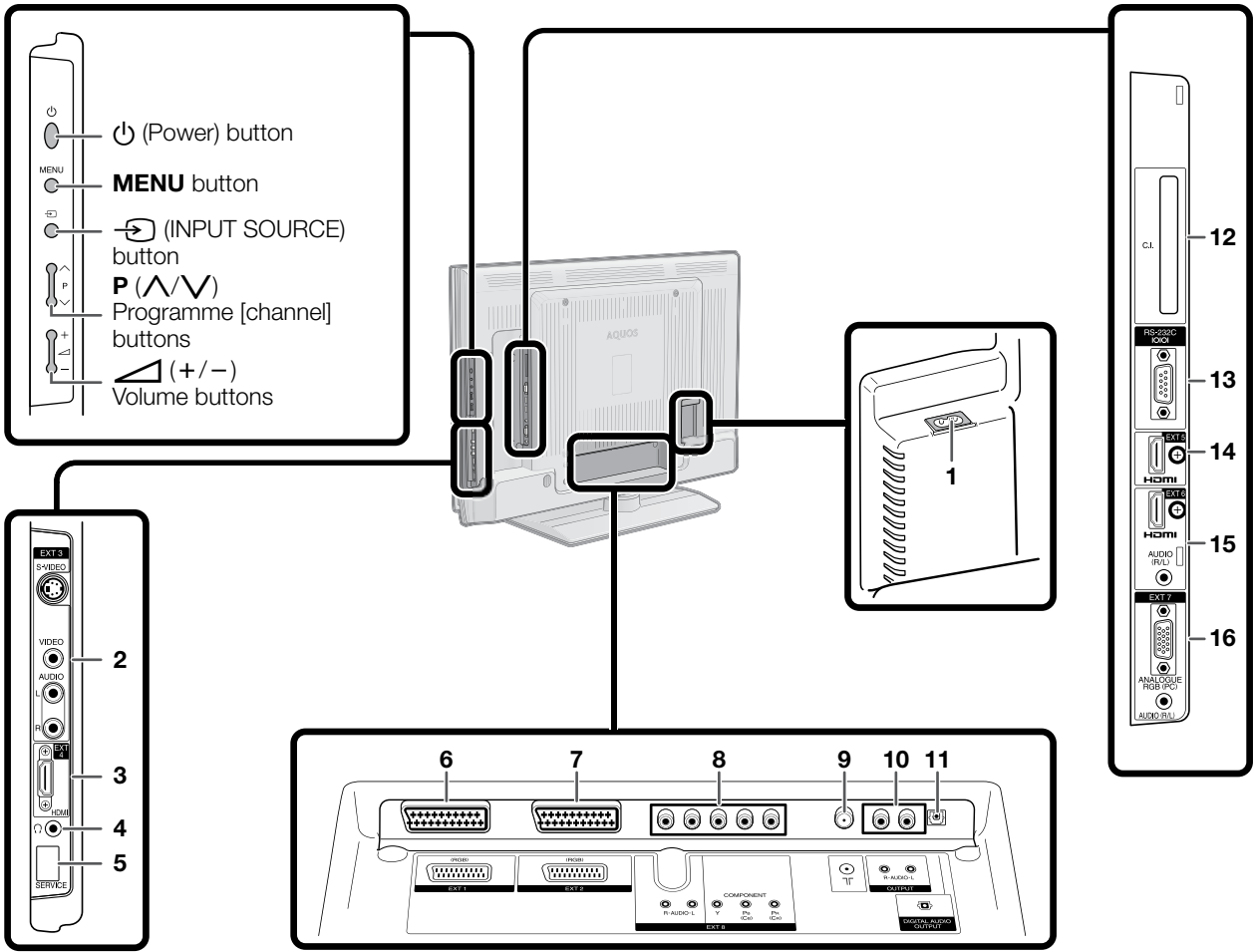

- 1 AC INPUT terminal
- 2 EXT 3 terminals
- 3 EXT 4 (HDMI) terminal
- 4 Headphones
- 5 SERVICE socket
- 6 EXT 1 (RGB) terminal
- 7 EXT 2 (RGB) terminal
- 8 EXT 8 (COMPONENT/AUDIO) terminals
- 9 Antenna terminal
- 10 OUTPUT (AUDIO) terminals
- 11 DIGITAL AUDIO OUTPUT terminal
- 12 COMMON INTERFACE slot
- 13 RS-232C terminal
- 14 EXT 5 (HDMI) terminal
- 15 EXT 6 (HDMI/AUDIO) terminals
- 16 EXT 7 (ANALOGUE RGB/AUDIO) terminals

Preparation

Supplied accessories

Remote control unit
(× 1)

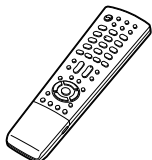

Pages 3 and 6

AC cord (× 1)

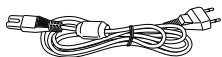

Page 8

Cable clamp (× 1)

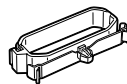

Page 8

Stand unit (× 1)



Page 5

• Operation manual (This publication)

• “AAA” size battery (× 2) ... Page 6

Attaching the stand unit

- Before attaching (or detaching) the stand, unplug the AC cord from the AC INPUT terminal.
- Before performing work spread cushioning over the base area to lay the TV on. This will prevent it from being damaged.

CAUTION

- **Attach the stand in the correct direction.**
- **Be sure to follow the instructions. Incorrect installation of the stand may result in the TV falling over.**

- 1** Confirm that there are 8 screws (4 short screws and 4 long screws) with the stand unit.

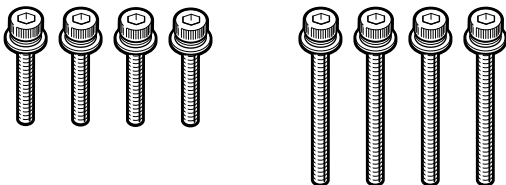

- 2** Attach the supporting post for the stand unit onto the base using the 4 long screws with the hex key (supplied) as shown.

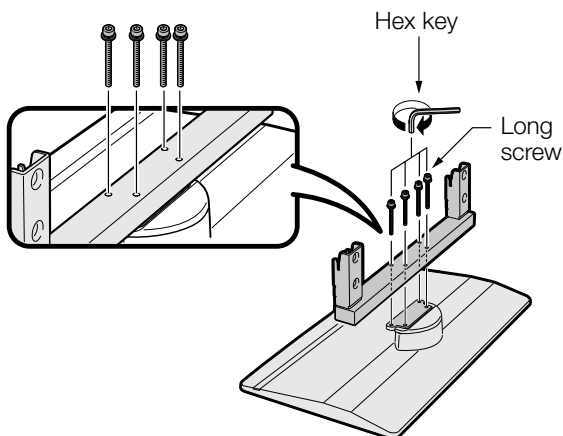

- 3** ① Insert the stand into the openings on the bottom of the TV. (Hold the stand so it will not drop from the edge of the base area.)
② Insert and tighten the 4 short screws into the 4 holes on the rear of the TV.

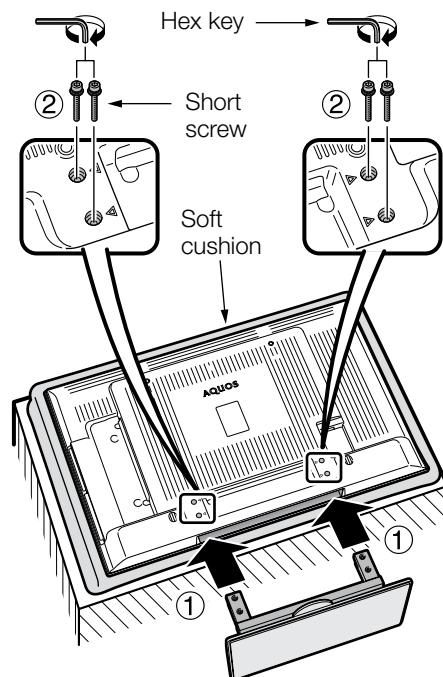

NOTE

- To detach the stand unit, perform the steps in reverse order.

Preparation

Inserting the batteries

Before using the TV for the first time, insert two “AAA” size batteries (supplied). When the batteries become depleted and the remote control unit fails to operate, replace the batteries with new “AAA” size batteries.

- 1 Open the battery cover.
- 2 Insert two supplied “AAA” size batteries.
 - Place batteries with their terminals corresponding to the (+) and (–) indications in the battery compartment.
- 3 Close the battery cover.

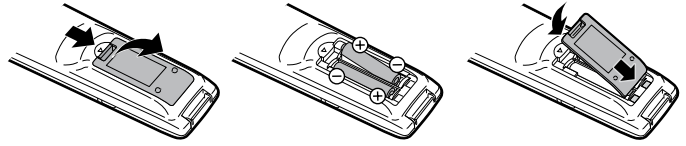

CAUTION

Improper use of batteries can result in chemical leakage or explosion. Be sure to follow the instructions below.

- Do not mix batteries of different types. Different types of batteries have different characteristics.
- Do not mix old and new batteries. Mixing old and new batteries can shorten the life of new batteries or cause chemical leakage in old batteries.
- Remove batteries as soon as they have worn out. Chemicals that leak from batteries can cause a rash. If you find any chemical leakage, wipe thoroughly with a cloth.
- The batteries supplied with this product may have a shorter life expectancy due to storage conditions.
- If you will not be using the remote control unit for an extended period of time, remove the batteries from it.

Note on disposing batteries:

The batteries provided contain no harmful materials such as cadmium, lead or mercury.

Regulations concerning used batteries stipulate that batteries may no longer be thrown out with the household rubbish. Deposit any used batteries free of charge into the designated collection containers set up at commercial businesses.

Using the remote control unit

Use the remote control unit by pointing it towards the remote control sensor. Objects between the remote control unit and sensor may prevent proper operation.

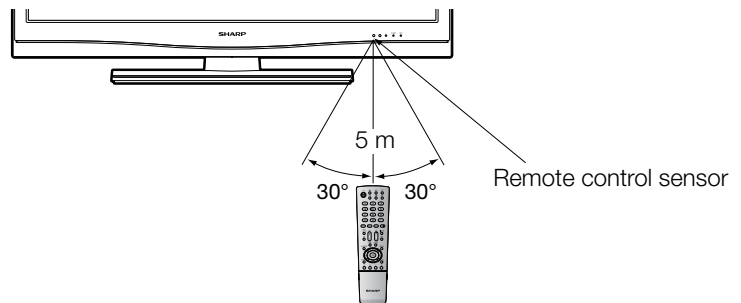

Cautions regarding the remote control unit

- Do not expose the remote control unit to shock. In addition, do not expose the remote control unit to liquids, and do not place in an area with high humidity.
- Do not install or place the remote control unit under direct sunlight. The heat may cause deformation of the unit.
- The remote control unit may not work properly if the remote control sensor of the TV is under direct sunlight or strong lighting. In such case, change the angle of the lighting or TV, or operate the remote control unit closer to the remote control sensor.

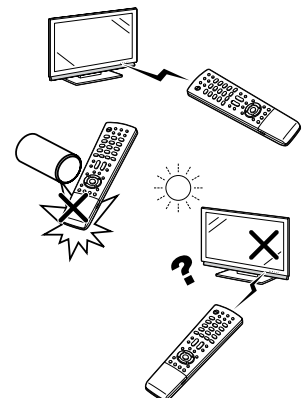

Quick guide

Initial installation overview

Follow the below steps one by one when using the TV for the first time. Some steps may not be necessary depending on your TV installation and connection.

1 Preparation

- 1 Connect antenna cable to the antenna terminal. (Page 8)

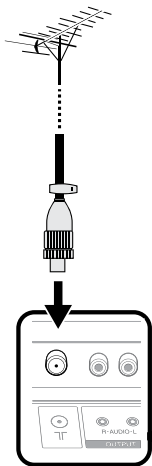

- 2 If necessary, insert CA card into the CI slot to watch scrambled broadcasts. (Pages 8 and 19)

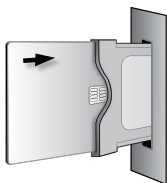

- 3 Connect the AC cord to the TV. (Page 8)

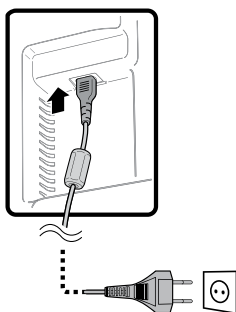

2 Power on and run the auto installation

- 1 Turn on the TV power with . (Page 10)

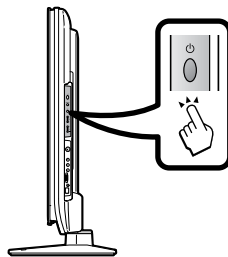

- 2 Run the initial auto installation. (Page 9)

- ✓ Language setting

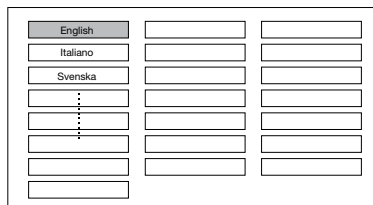

- ✓ Country setting

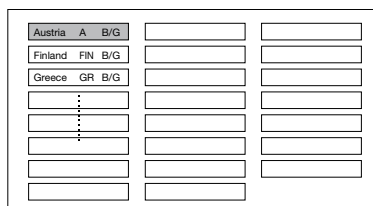

- ✓ Channel search setting



Start searching channels

3 Watch TV

- 1 **Congratulations!**
Now you can watch TV.

- 2 If necessary, adjust the antenna to attain maximum signal reception. (Page 9)

Connect external devices

- 1 Connect external devices such as a DVD as instructed. (Pages 15 - 17)

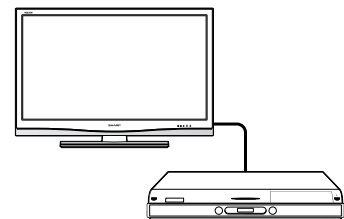

- 2 Connect external audio devices such as speakers/amplifier as instructed. (Pages 15 and 18)

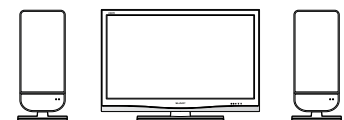

Before turning on the power

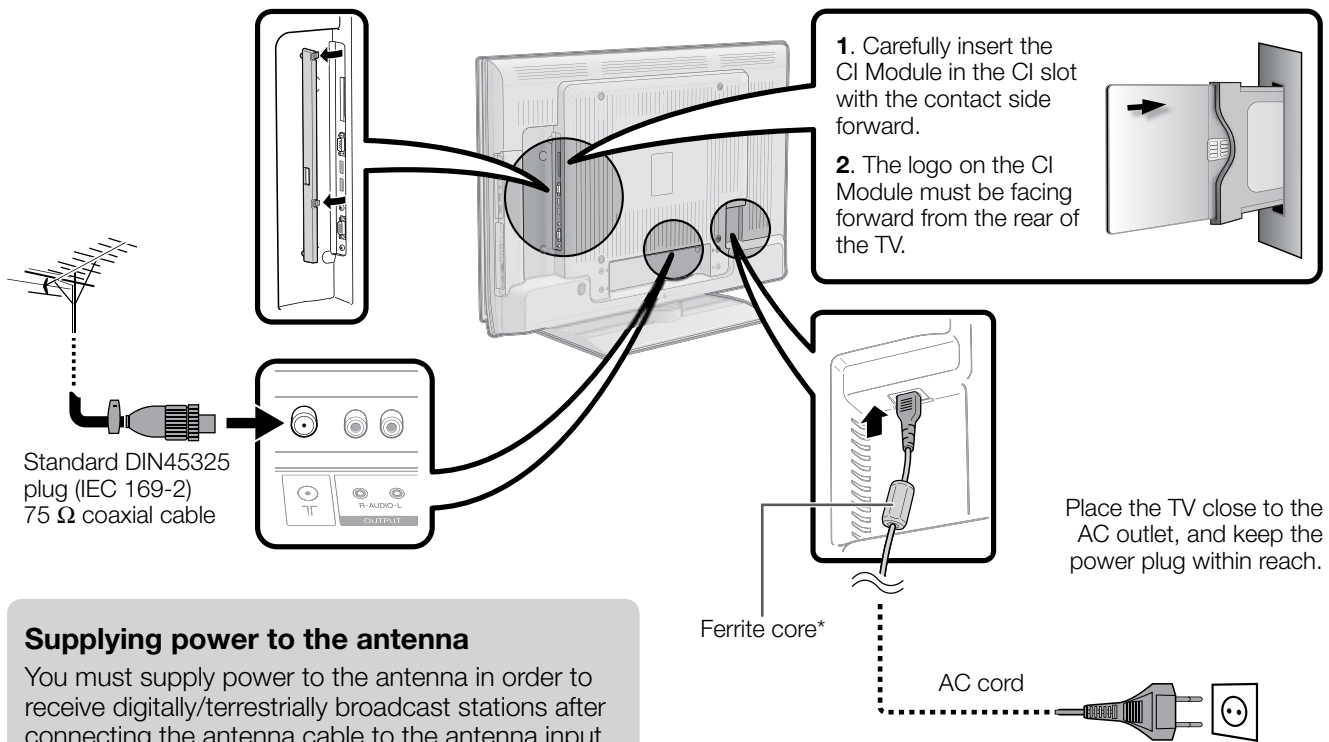

Supplying power to the antenna

You must supply power to the antenna in order to receive digitally/terrestrially broadcast stations after connecting the antenna cable to the antenna input terminal on the back of your TV.

1. Press **MENU** and the menu screen displays.
2. Press **◀/▶** to select "Setup".
3. Press **▲/▼** to select "Antenna Setup-DIGITAL", and then press **OK**.
4. Press **▲/▼** to select "Supply Voltage", and then press **OK**.
5. Press **◀/▶** to select "On", and then press **OK**.

*** Ferrite Core**

The Ferrite Core should be permanently attached and never removed from the AC cord.

- The AC cord is supplied either with a ferrite core or without a ferrite core. Neither type causes unnecessary electrical wave emissions or interference.

Setting the TV on the wall

- This TV should be mounted on the wall only with the wall mount bracket available from SHARP. (Page 39) The use of other wall mount brackets may result in an unstable installation and may cause serious injuries.
- Installing the LCD Colour TV requires special skill that should only be performed by qualified service personnel. Customers should not attempt to do the work themselves. SHARP bears no responsibility for improper mounting or mounting that results in accident or injury.
- You can ask a qualified service personnel about using an optional bracket to mount the TV to the wall.
- To use this TV mounted on a wall, first remove the adhesive tape at the 2 locations on the rear of the TV, and then use the screws supplied with the wall mount bracket to secure the bracket to the rear of the TV.
- When you mount the TV on the wall, you should attach the supporting post.

Bundling the cables

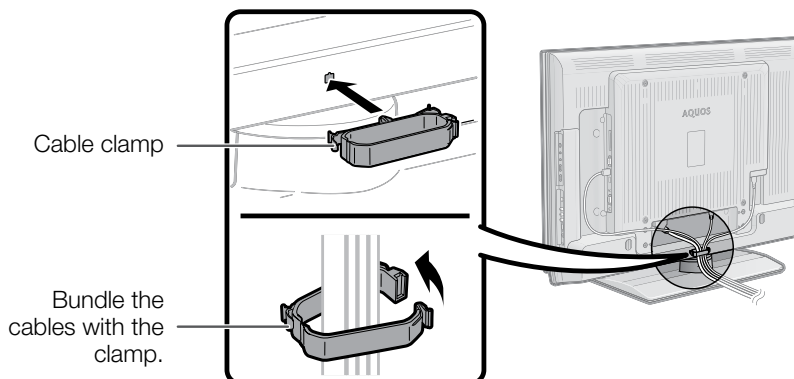

Quick guide

Initial auto installation





When the TV powers on for the first time after purchase, the initial auto installation wizard appears. Follow the menus and make the necessary settings one after another.

Confirm the following before turning on the power

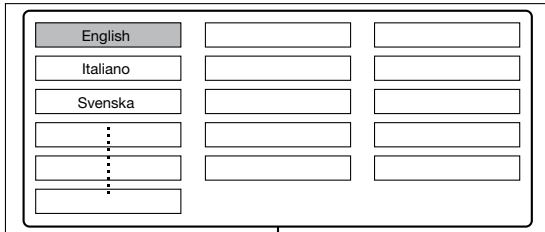
- Is the antenna cable connected?
- Is the AC cord plugged in?





- 1 Press  on the TV.
 - The initial auto installation wizard appears.
- 2 Setting the on-screen display language

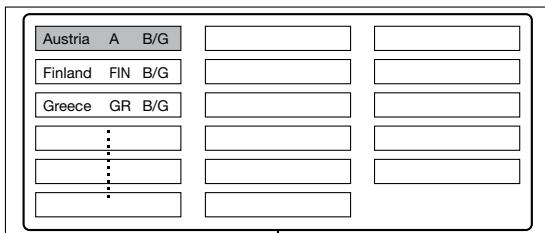

Press /// to select the desired language, and then press **OK**.

- 3 Setting the country (Location of TV set screen)



Press /// to select your country or area, and then press **OK**.

- The Location of TV set screen only appears during the first installation.

- 4 Starting channel search

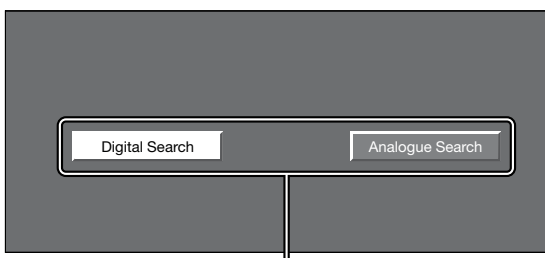

Press / to select "Digital Search" or "Analogue Search", and then press **OK**.

- If you want to search for more broadcasts, execute "Auto Installation" again from the Setup menu.





- 5 The TV searches for, sorts and stores all the receivable TV stations according to their settings and the connected antenna.
 - To abort the initial auto installation in progress, press **END**.

NOTE

- If you turn off the power on the TV after performing step 4, the initial auto installation wizard does not appear. The auto installation function allows you to execute the installation again from the Setup menu. (Page 26)
- The initial auto installation wizard will go off if you leave the TV unattended for 30 minutes before searching for channels in step 5.

Checking signal strength and channel strength

If you install a DVB-T antenna for the first time or relocate it, you should adjust the alignment of the antenna to receive a good reception while checking the antenna setup screen.



- 1 Press **MENU** and the menu screen displays.
- 2 Press / to select "Setup".
- 3 Press / to select "Antenna Setup-DIGITAL", and then press **OK**.

● Checking signal strength

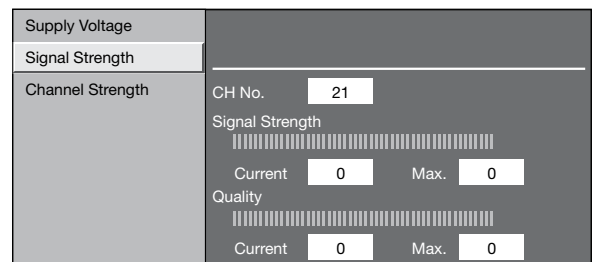
Press / to select "Signal Strength".



● Checking channel strength

Press / to select "Channel strength", and then press **OK**.

- You can input a specified frequency band using **0 - 9** numeric buttons.

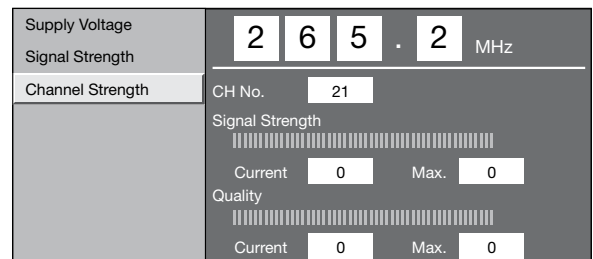

- 4 Position and align the antenna so that the maximum possible values for "Signal Strength" and "Quality" are obtained.

NOTE

- The values of "Signal Strength" and "Quality" indicate when to check the appropriate alignment of the antenna.

Watching TV

Daily operation

Switching on/off

Turning on/off the power

Press on the TV.
Switch it off by pressing on the TV.

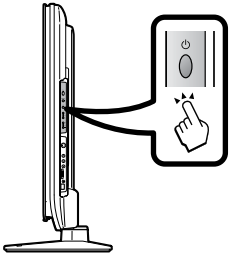

- However, please bear in mind that EPG data (electronic programme guide) will be lost, and programmed timer recordings will not be performed by the TV.

Standby mode

To standby mode

If the TV set is switched on, you can switch it to standby by pressing on the remote control.

Switching on from standby

From standby, press on the remote control.

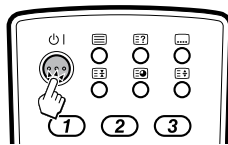

TV indicator status

indicator	Status
Off	Power off
Green	Power on
Red	Standby

NOTE

- If you are not going to use this TV for a long period of time, be sure to remove the AC cord from the power outlet.
- A small amount of electric power is still consumed even when is turned off.

Switching between analogue and digital broadcasts

Watching digital broadcasts



Watching analogue broadcasts



Changing channels

With /P/V:



With 0 - 9:

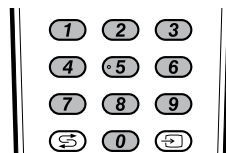

Selecting external video source

Once the connection is made, press to display the INPUT SOURCE screen, and then press to switch over to the appropriate external source with **OK**.

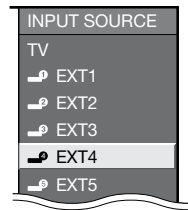

Selecting Sound mode

DTV mode:

- If multi sound modes are received, each time you press the mode switches as follows.

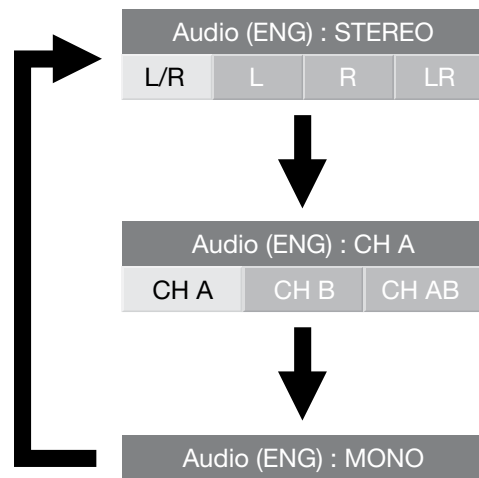

- Press to select L or R sound when the STEREO or DUAL MONO screen is displayed.



NOTE

- The sound mode OSD disappears in 6 seconds.
- Selectable items vary depending on the received broadcasts.

ATV mode:

Each time you press , the mode switches as illustrated in the following tables.

NICAM TV broadcasts selection	
Signal	Selectable items
Stereo	NICAM STEREO, MONO
Bilingual	NICAM CH A, NICAM CH B, NICAM CH AB, MONO
Monaural	NICAM MONO, MONO
A2 TV broadcasts selection	
Signal	Selectable items
Stereo	STEREO, MONO
Bilingual	CH A, CH B, CH AB
Monaural	MONO

NOTE

- When no signal is input, the sound mode will display "MONO".

EPG (Electronic Programme Guide)

EPG (Electronic Programme Guide) is a programme list that is displayed on the screen. With the EPG, you can check the schedule of DTV/RADIO/DATA, view detailed information about them, tune to an event currently on-air and set a timer for future events.

EPG Overview

● Basic functions

- Select a programme using EPG (Page 12)
- Check programme information (Page 12)

● Useful functions

- Search for a programme by category (Page 12)
- Search for a programme by date and time (Page 12)
- Timer recoding using EPG (Page 13)

Useful settings for using EPG

Common Operation

- 1 Press **MENU** to display the menu screen.
- 2 Press **◀▶** to select “Digital Setup”.

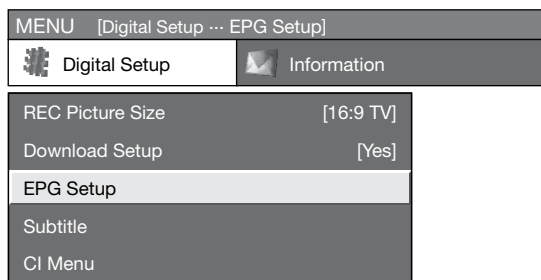

- 3 Press **▲▼** to select “EPG Setup”, and then press **OK**.

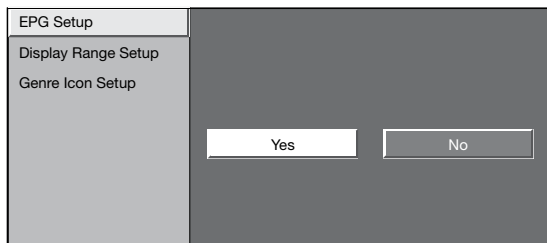

- 4 Press **◀▶** to select “Yes” or “No”, and then press **OK**.

EPG display settings

● EPG Setup (setting for receiving EPG data)

If you want to use the EPG for digital stations, select “Yes”. The EPG data must be automatically captured while the TV set is in standby mode. After setting to “Yes”, it may take some time to turn off the power using the remote control due to the process of the data capture.

NOTE

- If the TV main power is switched off, the EPG data will not capture.

● Display Range Setup

The Display range setup allows you to select three types of time spans for display on the screen.

Item

- Wide Angle:** Display six hours of programme information.
- Zoom:** Display three hours of programme information.
- Vertical Angle:** Change to the EPG display format with a vertical time span.

● Genre Icon Setup

You can grey out or place a mark on desired genres and smoothly search for programmes you frequently watch.

Genre Icon List

Icon	Genre	Icon	Genre
	Movie/Drama		Music/Ballet/Dance
	News/Current affairs		Arts/Culture (without music)
	Show/Game show		Social/Political Issues/Economics
	Sports		Education/Science/Factual Topics
	Children's/Youth programmes		Leisure hobbies

Selecting a programme using EPG

Basic Operation

● Display the EPG screen

Press **EPG**.

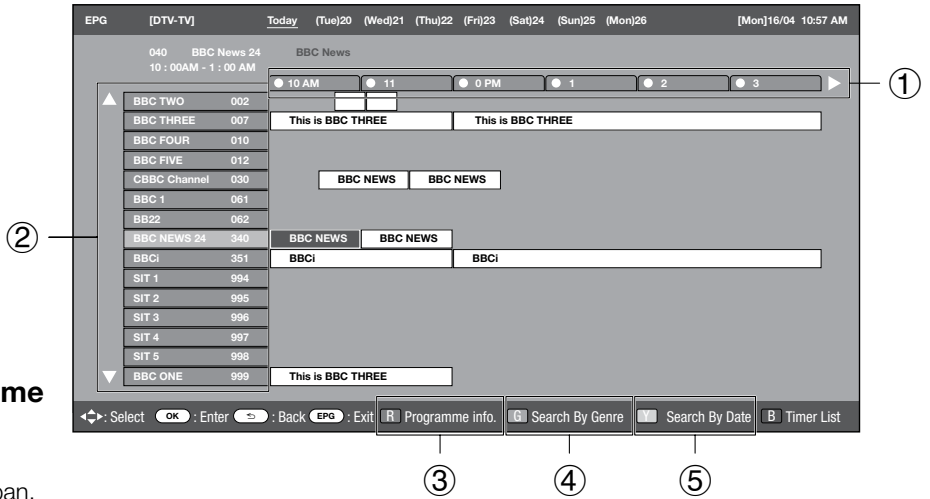

● Select a programme

① Press **◀/▶** to select the time span you want to search.

- Continue to press **▶** to display programmes in the next time span.

② Press **▲/▼** to select the desired programme.

- If **▲** or **▼** are displayed on the left of the services, continue to press **▲/▼** to display next or previous screen.

● Close the EPG screen

Press **EPG** again.

Selecting a programme

③ Check programme information

- 1 Press **▲/▼/◀/▶** to select the programme you want to check.
- 2 Press **R**.

Programme Information

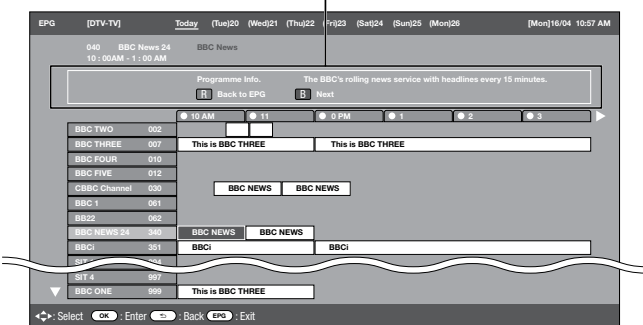

③ Press **OK** to tune to the selected programme.

④ Search a programme in a category

- 1 Press **G**.
- 2 Press **▲/▼** to select the desired genre, and then press **OK**.
- 3 Press **▲/▼** to select a programme you want to watch, and then press **OK**.

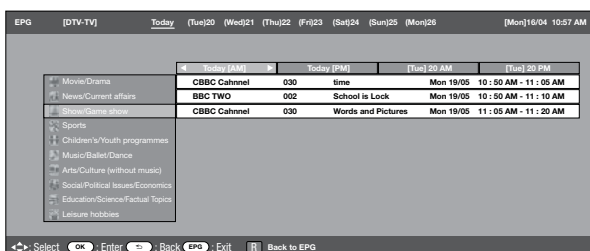

• Refer to page 11 for the genre setting.

⑤ Search for a programme by date/time

- 1 Press **Y**.
- 2 Press **◀/▶** to select the desired time span and then press **OK**.

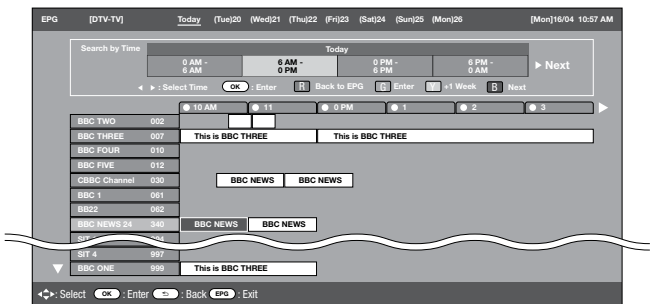

③ Press **▲/▼** to select the desired programme, and then press **OK**.

NOTE

- When you select a programme outside of the current time span, the timer setting screen displays. (Page 13)

Watching TV

Timer recording using EPG

You can record TV programmes using data from the EPG.

- 1 Press **EPG**.
- 2 Press **▲/▼/◀/▶** to select the programme you want to record, and then press **OK**.
- 3 Press **◀/▶** to select the preferred timer setting, and then press **OK**.

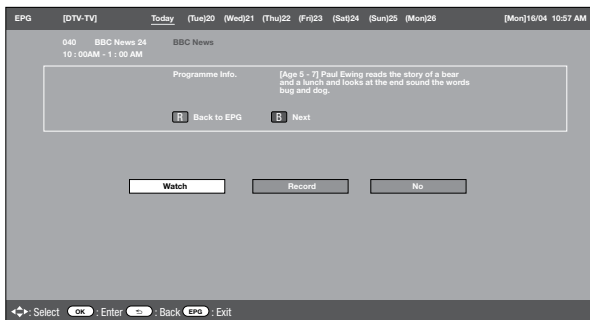

- If you select "No", the TV returns to the EPG screen.

● Selecting "Watch" in the timer setup screen

This setting allows you to switch to a programme at a set time.

- ① Press **◀/▶** to select "Watch", and then press **OK**.
- ② Press **◀/▶** to select "Yes", and then press **OK**.
 - The selected TV programme is marked with an icon.

● Selecting "Record" in the timer setup screen

This setting allows you to record a programme at a set time.

- ① Press **◀/▶** to select "Record", and then press **OK**.
- ② Press **◀/▶** to select the preferred timer recording type, and then press **OK**.

Item

AQUOS LINK: Record a programme at a set time when a device compatible with AQUOS LINK is connected.

AV LINK: Record a programme at a set time when a device compatible with AV LINK is connected.

VHS tape: Record a programme at a set time when a device compatible with VHS tape is connected.

NOTE

- Refer to pages 15-17 and 21 for connecting external devices.
- The selected TV programme is marked with an icon.

Cancelling the timer recording

- 1 Press **EPG**.
- 2 Press **▲/▼/◀/▶** to select the programme on timer setup, and then press **OK**.
- 3 Press **◀/▶** to select "Cancel", and then press **OK**.

● Cancelling using B button on the remote control



- 1 Press **EPG**.
- 2 Press **B** to display the timer recording screen.
- 3 Press **▲/▼** to select a programme with a set timer recording you want to change, and then press **OK**.
- 4 Press **◀/▶** to select "Cancel" and then press **OK**.

Teletext

What is Teletext?

Teletext broadcasts pages of information and entertainment to specially equipped television sets. Your TV receives Teletext signals broadcast by a TV network, and decodes them into graphical format for viewing. News, weather and sports information, stock exchange prices and programme previews are among the many services available.

Turning on and off Teletext



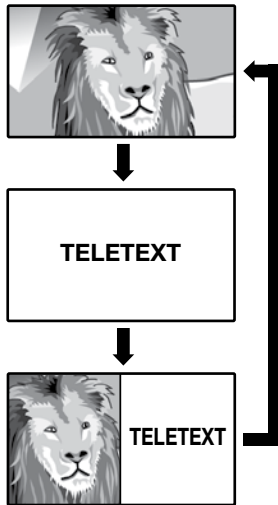

- 1 Select a TV channel or external source providing a Teletext programme.
- 2 Press  to display the Teletext.
 - Many stations use the TOP operating system, while some use FLOF (e.g. CNN). Your TV supports both these systems. The pages are divided into topic groups and topics. After switching on the teletext, up to 2000 pages are stored for fast access.
 - Each time you press , the screen switches as shown below.
 - Press  again to display the Teletext on the right screen and the normal image on the left screen.
 - If you select a programme with no Teletext signal, "No Teletext available." displays.
 - The same message displays during other modes if no Teletext signal is available.



NOTE

- Teletext will not work if the selected signal type is RGB. (See page 32)

Buttons for teletext operations

Buttons	Description
P (^/∨)	Increase or decrease the page number.
Colour (R/G/Y/B)	Select a group or block of pages displayed in the coloured brackets at the bottom of the screen by pressing the corresponding Colour (R/G/Y/B) on the remote control unit.
0 - 9	Directly select any page from 100 to 899 by using 0 - 9 .
 (Top/Bottom/Full)	Switch the Teletext image to Top, Bottom or Full.
 (Reveal hidden Teletext)	Reveal or hide hidden information such as an answer to a quiz.
 (Freeze/Hold)	Stop updating Teletext pages automatically or release the hold mode.
 (Subtitle for Teletext)	Display the subtitle or exit the subtitle screen. <ul style="list-style-type: none"> • Subtitles will not be displayed when the service does not contain subtitle information.
 (Subpage)	Reveal or hide subpages. <ul style="list-style-type: none"> • R button: Move to the previous subpage. • G button: Move to the following subpage. • These two buttons are shown on the screen by the signs - and +.

Using the MHEG5 application (UK only)

Some services bring you programmes with the MHEG (Multimedia and Hypermedia Expert Group) application encoded, letting you experience DTV interactively. When provided, the MHEG5 application will start when you press .

Sample MHEG5 screen



Connecting external devices

● Before connecting ...

- Be sure to turn off the TV and any devices before making any connections.
- Firmly connect a cable to a terminal or terminals.
- Carefully read the operation manual of each external device for possible connection types. This also helps you get the best possible audiovisual quality to maximise the potential of the TV and the connected device.

Introduction to connections

The TV is equipped with the terminals as showed below. Find the cable corresponding the TV's terminal and connect the device.

NOTE

- The cables illustrated in pages 15 to 18 are commercially available items.

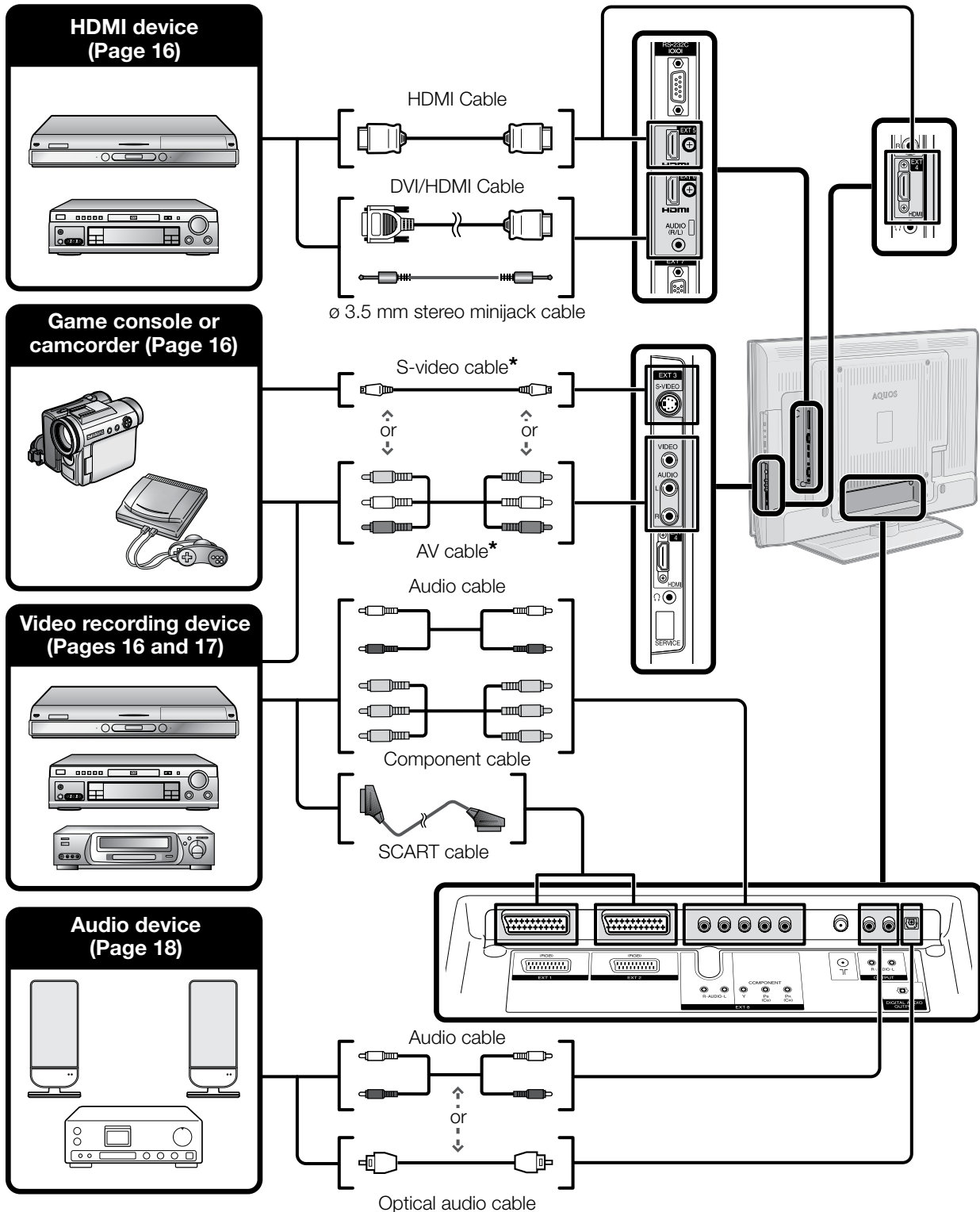

* When using an S-video cable, you also need to connect an audio cable (R/L).

Connecting external devices

HDMI connection

Example of connectable devices

- DVD ● Blu-ray player/recorder

The HDMI connections (High Definition Multimedia Interface) permit digital video and audio transmission via a connection cable from a player/recorder. The digital picture and sound data are transmitted without data compression and therefore lose none of their quality. Analogue/digital conversion is no longer necessary in the connected devices, which also would result in quality losses.

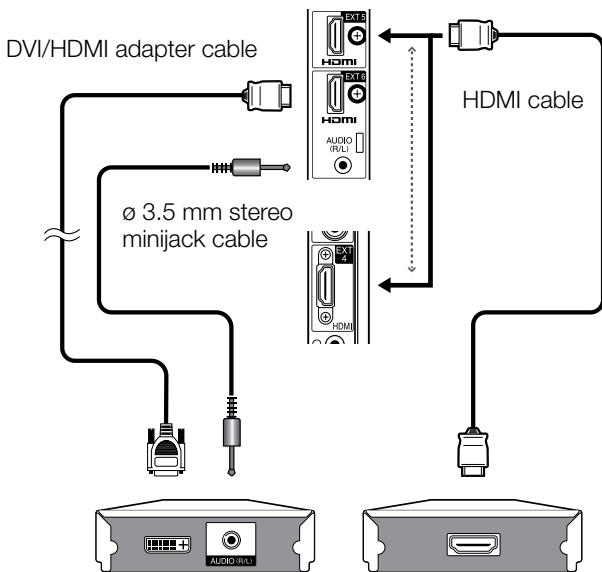

DVI/HDMI conversion

Using an DVI/HDMI adapter cable, the digital video signals of a DVD can also be played via the compatible HDMI connection. The sound must be fed in additionally.

Both HDMI and DVI use the same HDCP copy protection method.

After connecting

HDMI Audio Select

After connecting, you must set the audio signal compatible with the cable you use for the HDMI device.

- 1 Go to MENU > Option > HDMI Audio Select
- 2 Select "Digital" for audio signals via the HDMI terminal. Select "Analogue" for audio signals via the AUDIO jack (EXT6).

NOTE

- If a connected HDMI device is AQUOS LINK compatible, you can take advantage of versatile functions. (Pages 20 - 22)
- Video noise may occur depending on the type of HDMI cable used. Make sure to use certified HDMI cable.
- When playing the HDMI image, the best possible format for the picture will be detected and set automatically.

Supported video signal:

576i, 576p, 480i, 480p, 1080i, 720p, 1080p
See page 36 for PC signal compatibility.

Component connection

Example of connectable devices

- VCR ● DVD ● Blu-ray player/recorder

You will enjoy accurate colour reproduction and high quality images through the EXT 8 terminal when connecting a DVD recorder or other recording equipment.

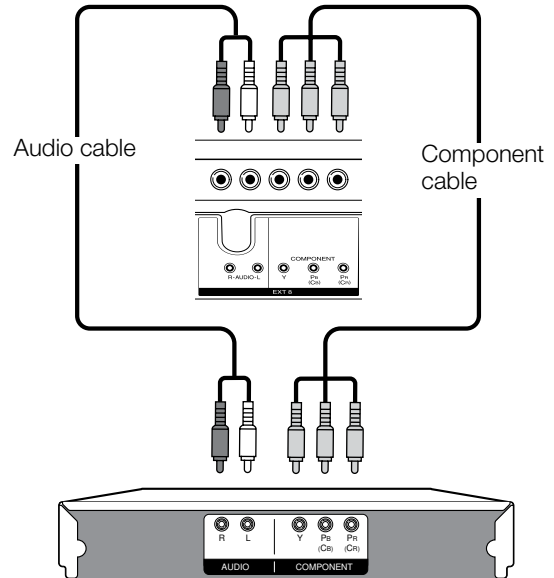

S-VIDEO/VIDEO connection

Example of connectable devices

- VCR ● DVD ● Blu-ray player/recorder
- Game console ● Camcorder

You can use the EXT 3 terminal when connecting to a game console, camcorder, a DVD recorder and some other equipment.

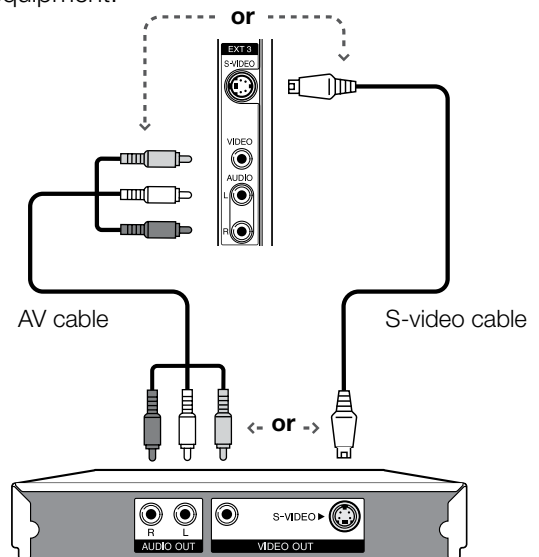

NOTE

- When using an S-video cable, you also need to connect an audio cable (R/L).
- EXT3: The S-VIDEO terminal has priority over the VIDEO terminal.

Connecting external devices

SCART connection

Example of connectable devices

- Decoder

● When using the EXT 1 (SCART) terminal

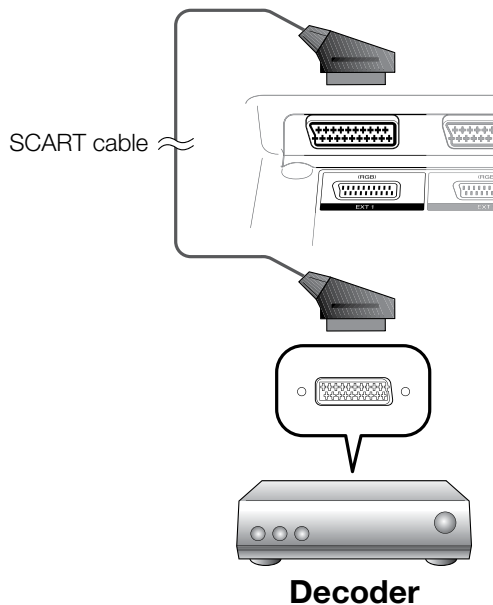

Example of connectable devices

- VCR ● DVD recorder

● When using the EXT 2 (SCART) terminal

If your VCR supports TV-VCR advanced AV Link systems, you can connect the VCR using a fully wired SCART cable.

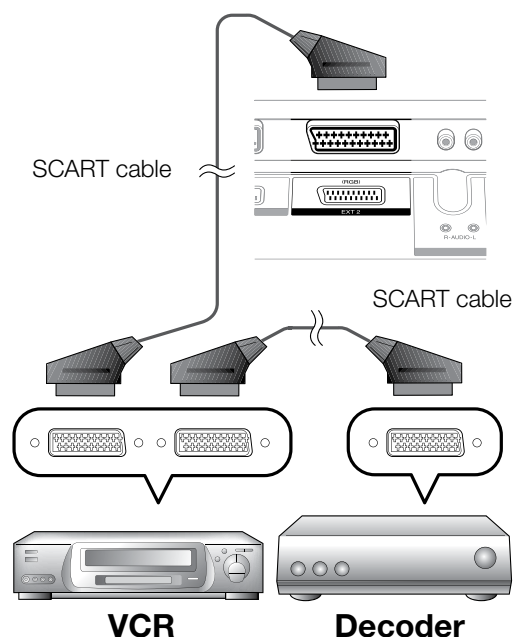

NOTE

- In cases when the decoder needs to receive a signal from the TV, make sure to select the appropriate input terminal to which the decoder is connected in "Manual adjust" in the "Analogue Setting" menu. (Page 27)
- TV-VCR advanced AV Link systems may not be compatible with some external sources.
- Do not connect the decoder to the EXT2 terminal.
- You cannot connect the VCR with Decoder using a fully wired SCART cable when selecting "Y/C" under the EXT2 in the "Input Select" menu.

Controlling devices with SCART using AV Link

This TV incorporates four typical AV Link functions for smooth connections between the TV and other audiovisual equipment.

One Touch Play

While the TV is in standby mode, it automatically turns on and plays back the image from the audiovisual source (e.g. VCR, DVD).

TV Standby

When the TV enters standby mode, the connected audiovisual equipment (e.g. VCR, DVD) enters standby mode as well.

WYSIWYR (What You See Is What You Record)

When the remote control unit of the connected VCR has the WYSIWYR button, you can automatically start recording by pressing the WYSIWYR button.

Preset Download

Automatically transfers the channel preset information from the tuner on the TV to the one on the connected audiovisual equipment (e.g. VCR) via the EXT 2 terminal.

NOTE

- Refer to the operation manuals of external equipment for the details.
- Only works when the audiovisual equipment is connected to the EXT 2 terminal on the TV with AV Link via a fully wired SCART.
- The use of the AV Link function is only possible if the TV-set has enforced a complete auto installation with the connected audiovisual equipment. (Page 9, initial auto installation)
The availability of the AV Link function depends on the audiovisual equipment used. Depending on the manufacturer and type of equipment used, it is possible that the described functions may be completely or partially unusable.

Connecting external devices

Speaker/amplifier connection

Connect an amplifier with external speakers as shown below.

● Connecting an amplifier with digital audio input

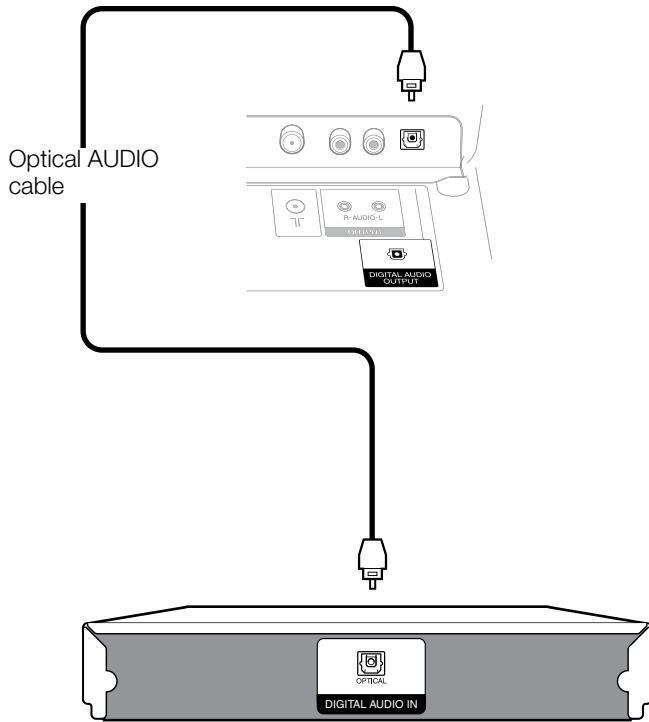

Amplifier with digital audio input

● Connecting an amplifier with analogue audio input

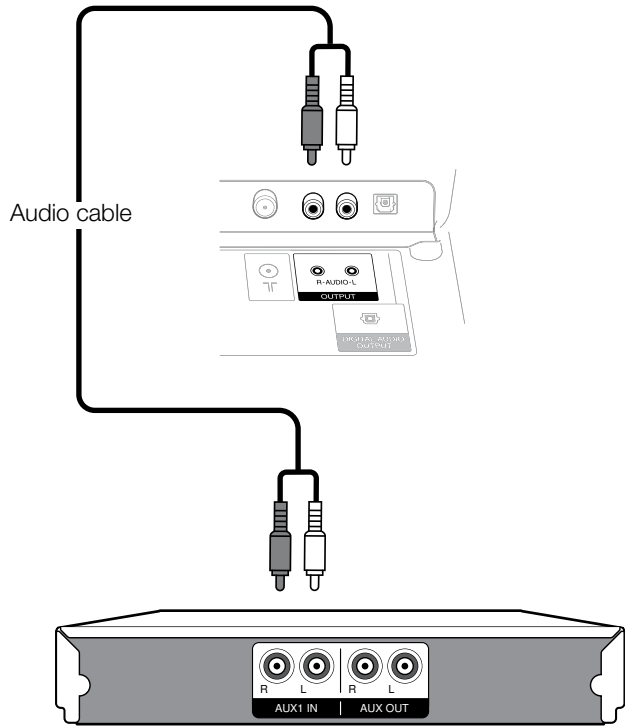

Amplifier with analogue audio input

● After connecting

Digital audio output setting

After connecting an amplifier with digital audio input and external speakers as shown, you should set an audio output format compatible with the programme you are watching or the device connected.

Go to MENU > Option > Digital Audio Output > select "PCM" or "Dolby Digital"

Connecting external devices

Inserting a CA Card

In order to receive coded digital stations, a Common Interface Module (CI Module) and a CA Card must be inserted in the CI slot of your TV set. (Page 8)
The CI Module and the CA Card are not supplied accessories. They are usually available from your dealer.

Inserting the CA Card into the CI Module

- 1 With the side with the gold coloured contact chip facing the side of the CI Module marked with the provider's logo, push the CA Card into the CI Module as far as it will go. Note the direction of the arrow printed on the CA Card.

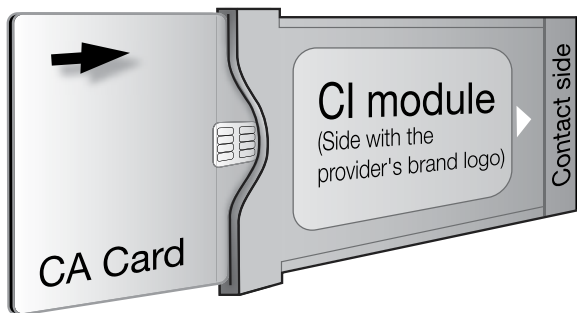

Inserting the CI Module in the CI slot

- 2 Remove the rear terminal cover.

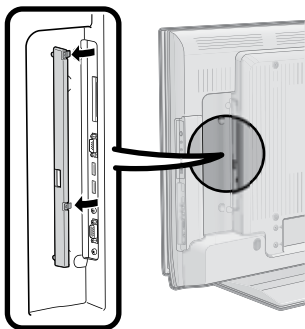

- 3 Carefully insert the CI Module in the CI slot with the contact side forward.

The logo on the CI Module must be facing forward from the rear of the TV. Do not use excessive force. Make sure the module is not bent in the process.

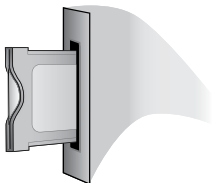

Checking CI Module information

NOTE

- Make sure that the CI Module is properly inserted.
- This menu is only available for digital stations.

- 1 Press **MENU** and the menu screen displays.
- 2 Press **◀/▶** to select "Digital Setup".
 - The content of this menu depends on the provider of the CI Module.
- 3 Press **▲/▼** to select "CI Menu", and then press **OK**.
- 4 Press **▲/▼** to select the following desired item, and then press **OK**.

● Module

General information on CI Module displays.

● Menu

Adjustment parameters of each CA CARD displays.

● Enquiry

You can input numerical values such as passwords here.

NOTE

- The content of each screen depends on the manufacturer of the CI module.

Removing the CI Module

- 1 Remove the cover from the rear of the set.
- 2 Remove the module from the set.
- 3 Replace the cover.

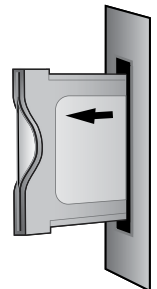

AQUOS LINK

Controlling HDMI devices using AQUOS LINK

What is AQUOS LINK?

Using the HDMI CEC (Consumer Electronics Control) protocol, with AQUOS LINK you can interactively operate compatible system devices (AV amplifier, DVD, Blu-ray Disc device) using a single remote control.

NOTE

- AQUOS LINK-compatible AQUOS BD Player, AQUOS AUDIO speaker system and AQUOS Recorder are to be on sale after the release of this TV. (As of September 2007)

What you can do with AQUOS LINK

✓ One Touch Recording (DTV only)

You do not have to search for the remote control of your recording device. Press the **REC** ● or **REC STOP** ■ buttons inside the flip cover to start/stop recording what you see on the recorder.

✓ One Touch Play

While the TV is in standby mode, it automatically turns on and plays back the image from the HDMI source.

✓ Single remote control operation

The AQUOS LINK automatically recognises the connected HDMI device and you can control the TV and the devices as if using a universal remote control.

✓ Operating Title list of external devices

In addition to displaying the TV's own Timer list (Page 12), you can also call up the external player's Top menu or AQUOS BD Player's/AQUOS Recorder's Title list provided that the devices support AQUOS LINK.

✓ Multiple control of HDMI devices

You can select which HDMI device to operate using the **OPTION** button.

NOTE

- When you use AQUOS LINK, make sure to use a certified HDMI cable.
- Point the remote control toward the TV, not to the connected HDMI device.
- Video noise may occur depending on the type of HDMI cable used. Make sure to use a certified HDMI cable.
- Up to 3 HDMI recording devices, one AV amplifier and two players can be connected using this system.
- These operations affect the HDMI device selected as the current external source. If the device does not operate, turn on the device and select the appropriate external source using .
- When you insert/remove HDMI cables or change connections, turn on all connected HDMI devices before turning on the TV. Confirm that picture and audio are correctly output by selecting "EXT4", "EXT5" or "EXT6" from the INPUT SOURCE menu.

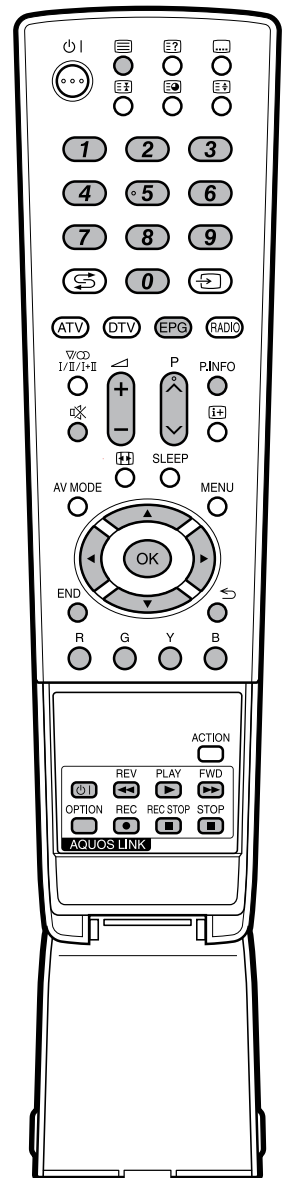

AQUOS LINK

AQUOS LINK connection

First connect the AQUOS AUDIO speaker system or an AQUOS BD Player/AQUOS Recorder that supports the HDMI CEC protocol.

NOTE

- Refer to the operation manual of the device to be connected for further details.
- After unplugging connection cables or changing the connection pattern, first turn on the power of the TV with all relevant device's power turned on. Change the external input source by pressing , select the appropriate external source and verify the audiovisual output.
- The cables illustrated in the following explanation are commercially available items.

Connecting an AQUOS BD Player/AQUOS Recorder via the AQUOS AUDIO speaker system

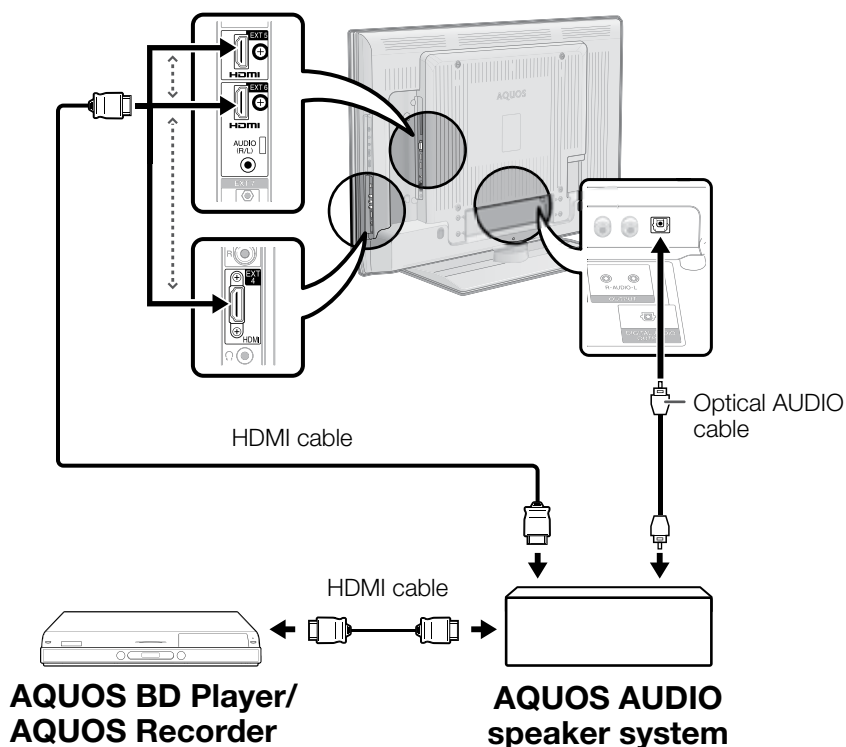

Connecting an AQUOS BD Player/AQUOS Recorder only

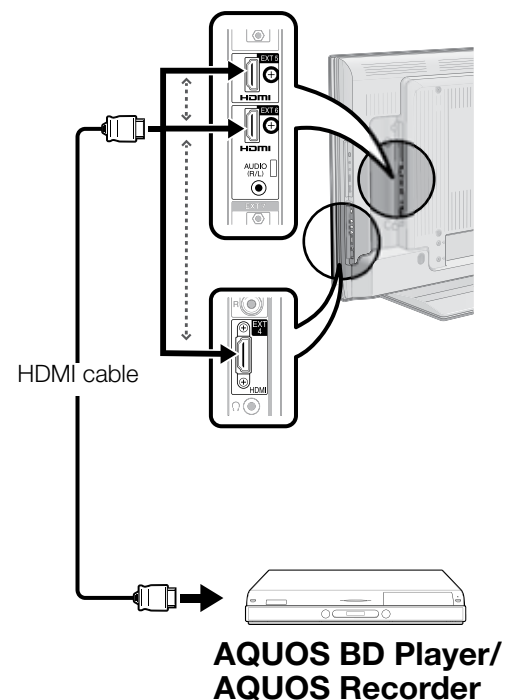

AQUOS LINK Setup

AQUOS LINK Auto power on

If this is activated, the One Touch Play function is enabled. While the TV is in standby mode, it automatically turns on and plays back the image from the HDMI source.

- 1 Press **MENU** and the menu screen displays.
- 2 Press **◀/▶** to select "Option".
- 3 Press **▲/▼** to select "AQUOS LINK Setup", and then press **OK**.
- 4 Press **▲/▼** to select "Auto Power On", and then press **OK**.
- 5 Press **◀/▶** to select "On", and then press **OK**.

NOTE

- The factory default for this item is "Off".

Selecting recorder

Here, you can select a recorder for the recording from several connected recorders.

- 1 Repeat steps 1 to 3 in **AQUOS LINK Auto power on**.
- 2 Press **▲/▼** to select "Selecting Recorder", and then press **OK**.
- 3 Select the recorder, and then press **OK**.

NOTE

- If you have connected the AQUOS AUDIO speaker system between the TV and an AQUOS Recorder, the external source's indication changes from "EXT5" to "EXT5 (Sub)".

Using Genre Info.

This function allows you to automatically switch to the appropriate sound mode depending on the genre information included the digital broadcast.

- 1 Repeat steps 1 to 3 in **AQUOS LINK Auto power on**.
- 2 Press **▲/▼** to select "Using Genre Info.", and then press **OK**.
- 3 Press **◀/▶** to select "On", and then press **OK**.

Operating an AQUOS LINK device

AQUOS LINK allows you to operate the HDMI-connected device with one remote control.

- 1 Open the remote control's flip cover.
- 2 Press **PLAY** ► to start playback of a title.
 - See the right column, section “**Playback of titles using AQUOS LINK**” if you want to start playback using the list of the titles of the AQUOS BD Player/AQUOS Recorder.
- 3 Press **FWD** ►► to fast forward.
Press **REV** ◀◀ to reverse.
Press **STOP** ■ to stop.
Press **⏻** | to turn the HDMI-connected device on/off.

Listening with the AQUOS AUDIO speaker system

You can opt to listen to the TV sound only from the AQUOS AUDIO speaker system.

- 1 Open the remote control's flip cover.
- 2 Press **OPTION**.

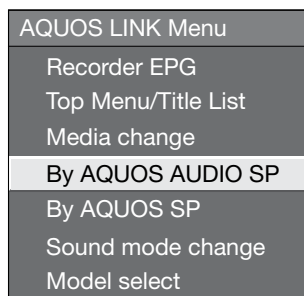

- 3 Press ▲/▼ to select “By AQUOS AUDIO SP”, and then press **OK**.
 - The sound from the TV speaker and headphone terminal is silenced and only the sound from the AQUOS AUDIO speaker system is audible.

Listening with the AQUOS TV speaker system

You can opt to listen to the TV sound only from the AQUOS TV speaker system.

- 1 Open the remote control's flip cover.
- 2 Press **OPTION**.
 - The AQUOS LINK Menu displays.
- 3 Press ▲/▼ to select “By AQUOS SP”, and then press **OK**.

Manually changing the AQUOS AUDIO speaker system's sound mode

- 1 Open the remote control's flip cover.
- 2 Press **OPTION**.
 - The AQUOS LINK Menu displays.
- 3 Press ▲/▼ to select “Sound mode change”.
- 4 The sound mode changes every time you press **OK**.
 - Refer to the operation manual of the AQUOS AUDIO speaker system for details.

Playback of titles using AQUOS LINK

This section explains how to play back a title in the AQUOS BD Player/AQUOS Recorder.

- 1 Open the remote control's flip cover.
- 2 Press **OPTION**.
 - The AQUOS LINK Menu displays.
- 3 Press ▲/▼ to select “Top Menu/Title List”, and then press **OK**.
 - The linked recorder now powers on and the TV automatically selects the appropriate external input source.
 - The title list data from the connected AQUOS BD Player/AQUOS Recorder displays.
- 4 Select the title with ▲/▼/◀/▶, and then press **PLAY** ►.

Selecting media type for CEC-compatible recorder

If your recorder has multiple storage media, select the media type here.

- 1 Open the remote control's flip cover.
- 2 Press **OPTION**.
 - The AQUOS LINK Menu displays.
- 3 Press ▲/▼ to select “Media change”, and then press **OK**.
- 4 Select the desired medium, such as DVD or HDD. The media type changes every time you press **OK**.

HDMI device selection

If multiple HDMI devices are connected in a daisy chain, you can specify which device to control here.

- 1 Open the remote control's flip cover.
- 2 Press **OPTION**.
 - The AQUOS LINK Menu displays.
- 3 Press ▲/▼ to select “Model select”, and then press **OK**. The HDMI device changes every time you press **OK**.

Recording via the AQUOS Recorder EPG (only for recorders)

You can call up the CEC-compatible recorder's EPG and preset timer recordings using the TV's remote control.

- 1 Open the remote control's flip cover.
- 2 Press **OPTION**.
 - The AQUOS LINK Menu displays.
- 3 Press ▲/▼ to select “Recorder EPG”, and then press **OK**.
 - The external input source switches and the recorder's EPG is displayed.
- 4 Select the programme to record.
 - Refer to the operation manual of the recorder for details.

Menu operation

What is the Menu?

- You need to bring up the On-Screen Display to perform settings for the TV. The On-Screen Display for the settings is called "Menu".
- The Menu enables various settings and adjustments.
- The Menu can be operated with the remote control unit.

Common operations

1 Display the Menu Screen

Press **MENU** and the MENU screen displays.

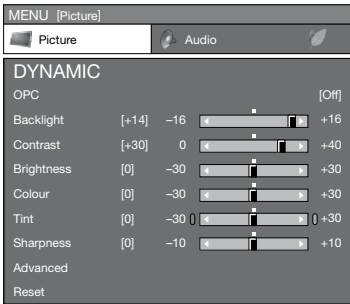

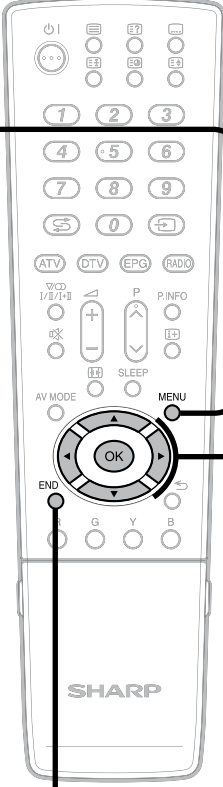

2 Select an item

Press **▲/▼/◀/▶** to select/adjust the desired menu, and adjust the item to the desired level, and then press **OK**.

Press **↶** to return to the previous Menu page.

- **Selecting in the Menu**

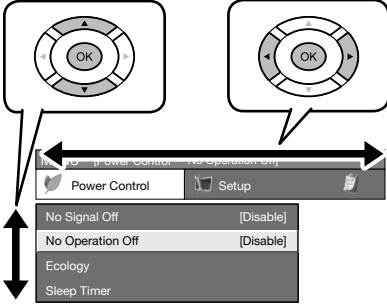

- **Selecting options**

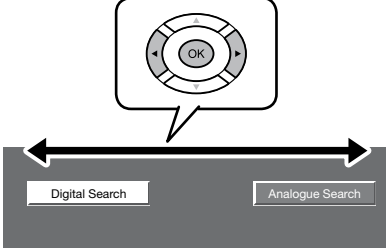

3 Exit the Menu screen

The operation will exit the menu screen if you press **END** before it is completed.

NOTE

- Menu options differ in the selected input modes, but the operating procedures are the same.
- The screens in the operation manual are for explanation purposes (some are enlarged, others cropped) and may vary slightly from the actual screens.
- Items with  cannot be selected for various reasons.

Operation without a remote control

This function is useful when there is no remote control within your reach.

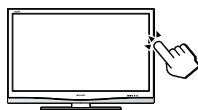

- 1 Press **MENU** briefly to display the direct control screen.
- 2 Press **P ▲/▼** instead of **▲/▼** or **◀/▶** instead of **◀/▶** to select the item.
- 3 Press **→** to complete the setting.

NOTE

- The direct control menu screen will disappear if left unattended for several seconds.

About the Guide Display

The Guide Display at the bottom of the screen shows operations with an On-Screen Display.



The bar above is an operational guide for the remote control. The bar will change in accordance with each menu setting screen.

Basic adjustment

Picture Settings

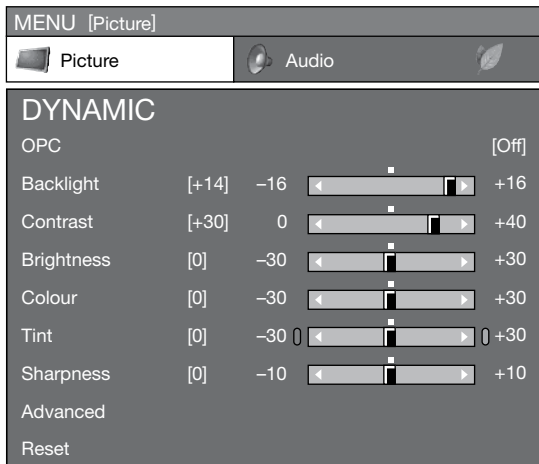

Picture OPC

Automatically adjust the brightness of the screen.

Item

- Off:** The brightness is fixed at the value set in Backlight.
- On:** Automatically adjusts
- On:Display:** Displays the OPC effect on the screen while adjusting the brightness of the screen.

NOTE

- When set to "On", the TV senses the surrounding light and automatically adjusts the backlight brightness. Make sure no object obstructs the OPC sensor, which could affect its ability to sense surrounding light.

Picture Picture adjustments

Adjust the picture to your preference with the following picture settings.

Adjustment items

Selectable items	◀ button	▶ button
Backlight	The screen dims	The screen brightens
Contrast	For less contrast	For more contrast
Brightness	For less brightness	For more brightness
Colour	For less colour intensity	For more colour intensity
Tint	Skin tones become purplish	Skin tones become greenish
Sharpness	For less sharpness	For more sharpness

Picture Advanced

This TV provides various advanced functions for optimising the picture quality.



Colour Temp.

Adjust the colour temperature to give the best white image.

Item

- High:** White with bluish tone
- Mid-High:** Intermediate tone between High and Middle
- Middle:** Natural tone
- Mid-Low:** Intermediate tone between Middle and Low
- Low:** White with reddish tone

Action Mode

This function improves LCD response and moving picture quality by reducing motion blur.

Press **ACTION** to turn the Action Mode on/off.

- The Action Mode screen indicates the current on/off status.
- The Action Mode screen goes out after several seconds.

Film Mode

Automatically detects a film-based source (originally encoded at 24/25 frames/second, depending on the vertical frequency), analyses it and then recreates each still film frame for high-definition picture quality.

Active Contrast

Automatically adjusts the contrast of an image according to the scene.

3D-Y/C

Provide high quality images with minimal dot crawl and cross colour noise by detecting changes in the image.

Item

- Standard:** Normal adjustment
- Fast:** Set the optimum image quality for fast-moving images.
- Slow:** Set the optimum image quality for slow-moving images.
- Off:** No detecting

NOTE

- 3D-Y/C may not operate depending on the input signal type or noisy input signal.
- 3D-Y/C has even more effect on composite video signals (CVBS).

Basic adjustment

Monochrome

For viewing a video in monochrome.

Range of OPC

The brightness level range of the OPC sensor's automatic adjustments can be set according to your preferences. The adjustment range of the OPC sensor can be set to a maximum of +16 and a minimum of -16.

Selectable items	Description
Max.	-16 through +16
Min.	-16 through +16

NOTE

- This function is available only when the "OPC" setting is set to "On" or "On: Display".
- The maximum setting cannot be set to a smaller number than the minimum setting.
- The minimum setting cannot be set to a bigger number than the maximum setting.
- The maximum and minimum settings cannot be set to the same number.
- Depending on the brightness of the surrounding light, the OPC sensor might not operate if the adjustment range is small.

AV Mode

AV Mode gives you five viewing options to choose from to best match the system environment, which can vary due to factors like room-brightness, type of programme watched or the type of image input from external equipment.

- 1 Press **AV MODE**.
- 2 Each time you press **AV MODE**, the mode changes.
 - You can also switch the mode on the "Picture" and "Audio" menu screen by pressing **AV MODE**.

Item

- STANDARD:** For a highly defined image in a normally bright room.
- MOVIE:** For viewing a movie in a darkened room.
- GAME:** For playing of video games.
- PC*:** For PC.
- xvYCC**:** Produce realistic colour on the TV screen unlike any other signal.
- USER:** Allows the user to customise settings as desired. You can set the mode for each input source.
- DYNAMIC (Fixed):** For a clear-cut image emphasising high contrast for sports viewing. (The Picture and Audio settings cannot be adjusted.) Each setting value cannot be changed in this mode.
- DYNAMIC:** For a clear-cut image emphasising high contrast for sports viewing.

NOTE

- The item marked with * is available only when selecting "EXT4", "EXT5", "EXT6" or "EXT7" from the INPUT SOURCE menu.
- The item marked with ** is available only when accepting an xvYCC signal through an HDMI terminal.

Audio Settings

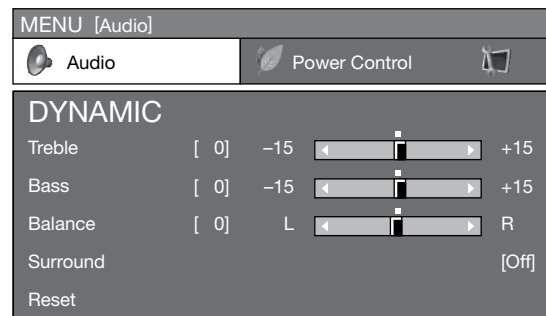

Audio

Audio adjustment

You can adjust the sound quality to your preference with the following settings.

Selectable items	◀ button	▶ button
Treble	For weaker treble	For stronger treble
Bass	For weaker bass	For stronger bass
Balance	Decrease audio from the right speaker	Decrease audio from the left speaker



Audio

Surround

This function allows you to enjoy realistic "live" sound.

Power Save Settings

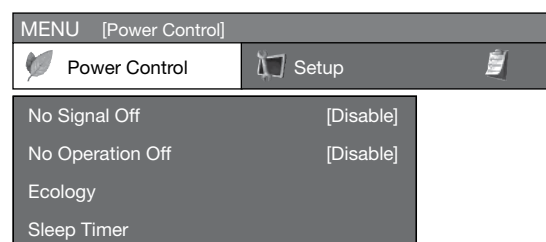

Power Control

No Signal Off

When set to "Enable" the TV will automatically enter the standby mode if there is no signal input for 15 minutes.

- Five minutes before the TV enters standby mode, the remaining time displays every minute.

NOTE

- When a TV programme finishes, this function may not operate.

Basic adjustment

Power Control No Operation Off

The TV will automatically enter the standby mode if no operations are performed during the time span you set ("30min." or "3hr.").

- Five minutes before the TV enters standby mode, the remaining time displays every minute.

Power Control Ecology

When set to "Yes" the TV activates the following power saving mode.

- OPC set to "On" (Page 24)
- Standby Mode set to "Mode 2" (Page 32)
- No Signal Off set to "Enable" (Page 25)
- No Operation Off set to "3hr." (Page 26)

Power Control Sleep Timer

Allows you to set a time when the TV automatically switches to standby.

NOTE

- Select "Off" to cancel the sleep timer.
- When the time has been set, countdown automatically starts.
- Five minutes before the preset of time expires, the remaining time displays each minute.

Channel Settings

Auto Installation

Setup Auto Installation

The TV automatically detects and stores all available services in your area. This function also allows you to perform the channel setting for "Digital" and "Analogue" individually and reconfigure the settings after the initial auto installation has been completed.

- 1 After selecting "Yes" on the screen, you can set language and channel search the same as in the initial auto installation. Follow steps 2, 4 and 5 on page 9.

NOTE

- You cannot set the country setting in "Auto Installation" in the Setup menu. If you want to reconfigure the country setting, automatically execute initial auto installation after executing "Reset" from the Setup menu.
- The current country setting is displayed on the screen.

Digital channel settings

Setup Programme Setup

Digital Setting

You can reconfigure DTV services settings automatically or manually.

Additional Search

Use this menu to add new services automatically after auto installation has been completed.

Manual Search

Add new services within a specified frequency band.

- Enter the frequency using **0 - 9** numeric buttons.

Manual Adjust

Configure various settings for each service using the **Colour (R, G, Y, B)** buttons.

Service No.	Service Name	Lock	CH Skip	EPG Skip	Old LCN
DTV 993	SIT 3				
DTV 994	SIT 2	✓		✓	
DTV 995	SIT 1		✓		
DTV 996	Monosco 576-2				
DTV 997	Monosco 576-1				
DTV 998	Color Bar 576i				
DTV 999	HD Monosco				

R : Lock G : CH Skip Y : EPG Skip B : Sort

- 1 Press **▲/▼** to select the desired service.
- 2 Press the colour button on the remote control corresponding with the item you want to reconfigure.
 - The **✓** mark indicates the operation is set to on. Each time the colour button is pressed, you can switch the corresponding operation on/off.

Buttons for Manual Adjust operation

Lock: Press R button.

When the service is locked, you must enter your PIN whenever you tune to the service.

CH Skip: Press G button.

Services with a **✓** mark are passed over when pressing **P▲/▼** in the TV/remote control unit.

EPG Skip: Press Y button.

Services with a **✓** mark are passed over in the Electronic Programme Guide (EPG).

Sort: Press B button.

The item position of services can be sorted.

- ① Press **▲/▼** to select the service whose item position you want to move, and then press **OK**.

DTV 994	SIT 2	✓	✓
DTV 995	SIT 1		✓

- ② Press **▲/▼** to move it to the desired position, and then press **OK**.

DTV 994	SIT 1		✓
DTV 995	SIT 2	✓	✓

- ③ Repeat steps 1 and 2 until all desired service items are sorted.

Basic adjustment

Analogue channel settings



Setup

Programme Setup

Analogue setting

You can reconfigure Analogue TV channels settings automatically or manually.

Additional search

Use this menu to add new channels automatically after auto installation has been made.

- Start searching channels after selecting colour system and sound system.

Manual Adjust

Use this menu to set up analogue TV channels manually.

After selecting “Yes” on the screen, press $\blacktriangle/\blacktriangledown/$ $\blacktriangleleft/\blacktriangleright$ to select the channel you want to set and the press **OK**.

Fine

You can adjust the frequency to the desired position.

NOTE

- Adjust while checking the background picture as a reference.
- Instead of pressing $\blacktriangleleft/\blacktriangleright$ to adjust the frequency, you can set by directly entering the frequency number of the channel with **0 - 9**.

EXAMPLE

- 179.25 MHz: Press **1** → **7** → **9** → **2** → **5**.
- 49.25 MHz: Press **4** → **9** → **2** → **5** → **OK**.

Colour sys.

Select the optimum colour system to receive. (Auto, PAL, SECAM)

Sound sys. (Broadcasting systems)

Select the optimum sound systems (Broadcasting systems) to receive. (B/G, D/K, I, L/L')

Label

When a TV channel sends its Network Name, the Auto Installation detects the information and assigns a name to it. However, you can change individual channel names.

- 1 Press $\blacktriangle/\blacktriangledown/$ $\blacktriangleleft/\blacktriangleright$ to select each character of the new name for the channel, and then press **OK**.
- 2 Repeat step 1 above until the name is fully spelt out.

NOTE

- The name can be 5 characters or less.
- If a channel name is less than 5 characters, select “END” to set the channel name.

Skip

Channels with “Skip” set to “On” are passed over when using **P** \blacktriangle /**P** \blacktriangledown even if selected while watching the image from the TV.

Decoder

When connecting a decoder to the unit, you need to select EXT1 or EXT2.

NOTE

- “Off” is factory preset value.

Lock

You can block the viewing of any channel.

NOTE

- See “Child Lock” for setting a PIN.
- When Lock is set to “On” for a channel, “Child lock has been activated.” displays, and the image and sound of the channel are blocked.
- When pressing \blacktriangleleft while “Child lock has been activated.” displays, the PIN input menu will display. Inputting the correct PIN lifts the child lock temporarily until the power is turned off.

Sort

Channel positions can be sorted freely.

- 1 Press $\blacktriangleleft/\blacktriangleright$ to select “Yes”, and then press **OK**.
- 2 Press $\blacktriangle/\blacktriangledown/$ $\blacktriangleleft/\blacktriangleright$ to select the channel you want to move, and then press **OK**.
- 3 Press $\blacktriangle/\blacktriangledown/$ $\blacktriangleleft/\blacktriangleright$ to move it to the desired position, and then press **OK**.
- 4 Repeat steps 3 and 4 until all desired channels are sorted.

Erase Programme

An individual programme can be erased.

- 1 Press $\blacktriangleleft/\blacktriangleright$ to select “Yes”, and then press **OK**.
- 2 Press $\blacktriangle/\blacktriangledown/$ $\blacktriangleleft/\blacktriangleright$ to select the channel you want to erase, and then press **OK**.
 - A message screen pops up.
- 3 Press $\blacktriangleleft/\blacktriangleright$ to select “Yes”, and then press **OK** to erase the selected programme. All the subsequent programmes move up.
- 4 Repeat steps 3 and 4 until all desired channels are erased.

Useful Viewing functions

Selecting the WSS picture size automatically



WSS allows a television to switch automatically among the different screen formats.

NOTE

- Use WIDE MODE if an image does not switch to the correct screen format. When the broadcast signal contains no WSS information, the function will not work even if enabled.

Selecting the WSS picture size manually



The WSS signal has 4:3 auto-switching that allows you to select between Panorama and Normal.

Item

- Normal:** Normal range keeping 4:3 or 16:9 aspect ratio
- Panorama:** Wide image without side bars

WSS signal 4:3 screen

4:3 mode "Normal"



4:3 mode "Panorama"



Selecting the picture size manually

You can select the picture size. Selectable picture size varies with the type of signal received.

Basically, if you set WSS to "On" in the Setup menu, the optimum Wide mode is automatically chosen for every broadcast. You can however, change the screen format manually as explained below.

NOTE

- Aside from manually changing the WIDE MODE as explained herein, the TV may detect and select the optimum WIDE MODE according to the signal received.

- 1 Press **[WIDE]**.
 - The WIDE MODE menu displays.
 - The menu lists the WIDE MODE options selectable for the type of video signal currently received.
- 2 Press **[WIDE]** or **[UP]**/**[DOWN]** while the WIDE MODE menu displays on the screen.
 - As you toggle the options, each is immediately reflected on the screen. There is no need to press **OK**.

Item (for SD [Standard] signals)

Normal: Keeps the original aspect ratio in a full screen display.

Zoom 14:9: For 14:9 letterbox pictures. A thin side bar appears on each side, and you may also see bars on the top and bottom with some programmes

Panorama: In this mode the picture is progressively stretched toward each side of the screen.

Full: For 16:9 squeeze pictures.

Cinema 16:9: For 16:9 letterbox pictures. Bars may appear on the top and bottom with some programmes.

Cinema 14:9: For 14:9 letterbox pictures. Bars may appear on the top and bottom with some programmes.

Item (for HD [High-Definition] signals)

Full: Display with an Overscan image. Crops all sides of screen.

Underscan: Display with an Underscan image only when receiving a 720p signal. Display with the High-Definition image adjusted optimally. Noise may appear on the edge of the screen with some programmes.

Dot by Dot: Displays an image with the same number of pixels on the screen when receiving 1080i/1080p signals only.

NOTE

- Some items do not appear depending on the type of received signal.

Useful Viewing functions

Selecting the recording picture size manually



Digital Setup

REC Picture Size

You can use this menu to set the appropriate picture size for viewing a 16:9 format TV programme on a 4:3 TV.

Setting to "4:3 TV"

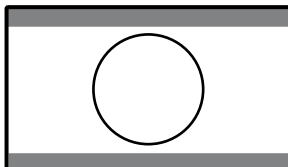

Setting to "16:9 TV"

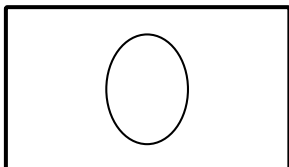

NOTE

- This function must be set before recording.

Selecting the HDMI picture size automatically



Setup

HDMI Auto View

This function allows you to automatically change to the appropriate picture size when viewing an HDMI signal using the EXT 4, 5 and 6 terminals.

Other Picture and audio settings

Adjusting image position



Setup

Position

For adjusting a picture's horizontal and vertical position.

Item

H-Pos.: Centres the image by moving it to the left or right.

V-Pos.: Centres the image by moving it up or down.

NOTE

- Adjustments are stored separately according to input source.
- Depending on the input signal type or WIDE MODE setting, a position setting may not be available.

Reducing noise on the screen



Option

DNR

DNR (Digital Noise Reduction) produces a clearer image. (Off, High, Low)

Automatic volume adjustment



Option

Auto Volume

Different sound sources sometimes do not have the same volume level, such as a programme and its commercial breaks. The Automatic Volume Control (Auto Volume) reduces this problem by equalizing levels.

Clear Voice



Option

Clear Voice

This function emphasises speech against background noise for greater intelligibility. It is not recommended for music sources.

Audio Only



Option

Audio Only

When listening to music from a music programme, you can set the TV off and enjoy audio only.

Item

Off: Both screen images and audio are output.

On: Audio is output without a screen image.

Useful Viewing functions

Display Settings

Channel display

You can display the channel information pressing **i+** on the remote control.

DTV Mode	ATV Mode
<p>BBC2</p> <p>DTV 001</p> <p>Audio (ENG) : STEREO Picture : 1080i Subtitle : 1/3 ENG New Information</p>	<p>BBC1</p> <p>ATV 01</p> <p>PAL NICAM Subtitle : Teletext Off New Information</p>

● Time display in channel information

You can display the time information included in DTV and Teletext broadcasts.

NOTE

- Skip step 1 if receiving DTV broadcasts.

- 1 Select a TV channel. (The time information is automatically captured.)
- 2 Press **i+**. The channel display will appear on the TV.
- 3 Press **i+** again within the several seconds that the channel display is on the screen. Time information will be shown on the lower-right corner of the display for several seconds.
- 4 Even when you change the TV channel, you can display the time information with steps 2 and 3 above.

NOTE

- If acquired successfully, the time information will appear in the upper-right corner of the screen by pressing **MENU**.

Time and Title display



Option

Time Display

Time Display

This function allows you to display the clock time on the lower right screen.

Item

- On:** Display the clock time.
- On (half-hourly):** Display the clock time in 30 minutes increments.
- Off:** Hide the clock time.

Time Format

You can select the time format (either 24HR or AM/PM) for the clock time.



Option

Game Play Time

This function allows you to display the elapsed time on the screen when AV MODE is set to "GAME".

Item

- On:** Under connecting a game console to the TV, the elapsed time is displayed in 30-minute increments after you start playing a game.
- Off:** Hide the time.



Option

Programme Title Display

This function allows you to display programme information on the screen including the title and airtime by tuning a channel.

NOTE

- This function is available only when the DTV mode is selected.

Other useful features

Setting when using external devices

Input source settings

Option
Input Select

For setting the signal type of external equipment.

Item

- EXT 1:** Y/C, CVBS, RGB
- EXT 2:** Y/C, CVBS, RGB
- EXT 3:** Auto, S-VIDEO, VIDEO

NOTE

- If no (colour) image displays, try changing to another signal type.
- Check the operation manual of the external equipment for the signal type.
- When the signal type is set to "Auto", the input terminal where a cable is connected is automatically selected.

Setup
Input Label

You can assign each input source a label as you prefer.

- 1 Press to select the desired input source.
- 2 Go to MENU> Setup> Input Label.
- 3 Press /// to select each character of the new name for the input source, and then press **OK**.

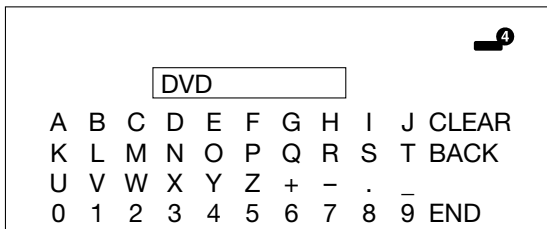

- 4 Repeat until the name is fully spelt out.

NOTE

- The name can be 6 characters or less.
- When you want to set an input source name of less than 6 characters, select "END" to set the name.



NOTE

- You cannot change labels if the input source is TV.

Skipping specified input

Setup
Input Skip

This setting allows you to skip the SCART, HDMI or RGB input on the "Input Select" menu.

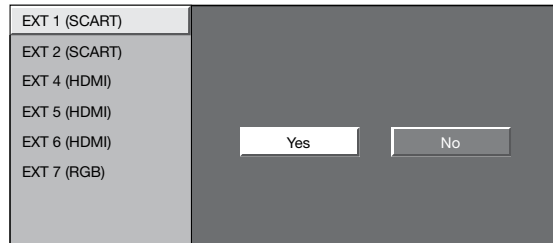

Colour system settings

Option
Colour System

You can change the colour system to one that is compatible with the image on the screen.

NOTE

- The factory preset value is "Auto".
- If "Auto" is selected, the colour system for each channel is automatically set. If an image does not display clearly, select another colour system (e.g. PAL, SECAM).

Additional features

Setup
Standby Mode

You can reduce the TV's start-up time after turning on the power with the remote control unit.

Item

- Mode1:** The TV quickly starts up from standby. 30W or more of power consumption is required.
- Mode2:** Power consumption is small during standby.

Connecting a PC

Connecting a PC

HDMI Connection

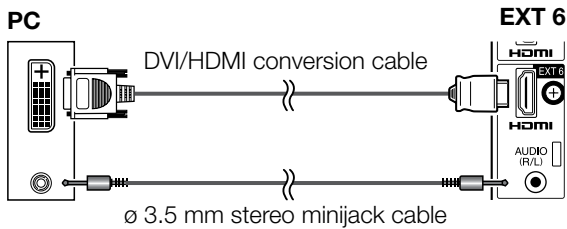
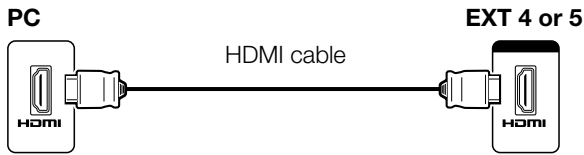

Analogue Connection

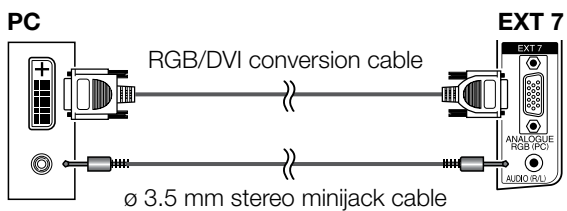
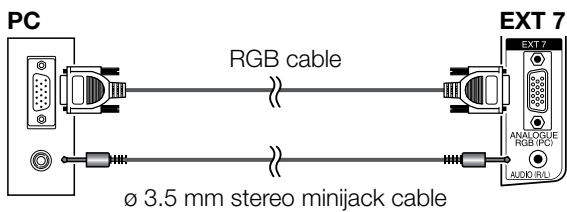

NOTE

- The PC input terminals are DDC1/2B-compatible.
- Refer to page 36 for a list of PC signals compatible with the TV.
- Macintosh adaptor may be required for use for some Macintosh computers.
- When connecting to a PC, the correct input signal type is automatically detected except 1024 × 768 and 1360 × 768 signals.

Displaying a PC image on the screen

Selecting the picture size

You can select the picture size.

- 1 Press .
 - The WIDE MODE menu displays.
- 2 Press or / to select a desired item on the menu.

NOTE

- Connect the PC before making adjustments.
- Selectable picture size may vary with input signal type.

EXAMPLE

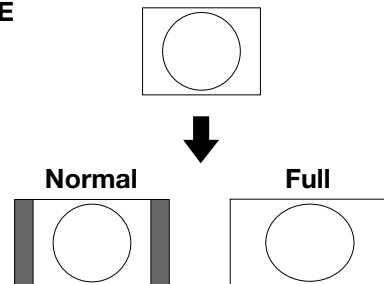

Item

Full: An image fully fills the screen.

Cinema: For letter box pictures. Bars may appear on the top and bottom with some programmes.

Normal: Keeps the original aspect ratio in a full screen display.

Dot by Dot: Displays an image with the same number of pixels on the screen.

NOTE

- Refer to page 29 for AV signals (480i/480p/576i/576p/720p/1080i/1080p). The analogue D-sub terminal (EXT7) is not compatible with 480i/576i/1080p signals.

Connecting a PC

Adjusting the PC image automatically

This function enables the screen to be automatically adjusted to its best possible condition when the analogue terminals of the TV and PC are connected with a commercially available DVI/D-sub conversion cable, etc.



NOTE

- When "Auto Sync." is successful, "Auto Sync completed successfully" displays. If not, "Auto Sync." failed.
- "Auto Sync." may fail even if "Auto Sync completed successfully" displays.
- "Auto Sync." may fail if the computer image has low resolution, has unclear (black) edges, or is moved while executing "Auto Sync."
- Be sure to connect the PC to the TV and switch it on before starting "Auto Sync."
- "Auto Sync." can be executed only when inputting analogue signals through the EXT 7 terminal.

Adjusting the PC image manually

Ordinarily you can easily adjust the picture as necessary to change image position using Auto Sync. In some cases, however, manual adjustment is needed to optimise the image.

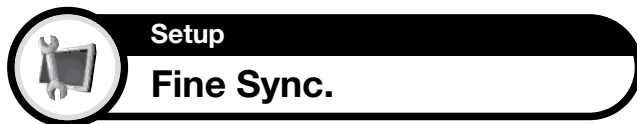

- 1 Press ▲/▼ to select the specific adjustment item.
- 2 Press ◀/▶ to adjust the item to the desired position.

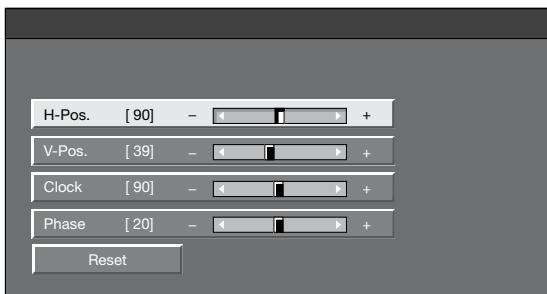

Item

- H-Pos.:** Centres the image by moving it to the left or right.
- V-Pos.:** Centres the image by moving it up or down.
- Clock:** Adjusts when the image flickers with vertical stripes.
- Phase:** Adjusts when characters have low contrast or when the image flickers.

NOTE

- For resetting all adjustment items to the factory preset values, press ▲/▼ to select "Reset", and then press **OK**.
- "Clock" and "Phase" in the "Fine Sync." menu can be adjusted only when inputting analogue signals.

Selecting input resolution

- Some input signals may have to be registered manually to display properly.
- The pairs of input signals (resolutions) in the list below are not distinguishable when received. In such cases, you have to set the correct signal manually. After setting once, it will display when the same signal (resolution) is input again.

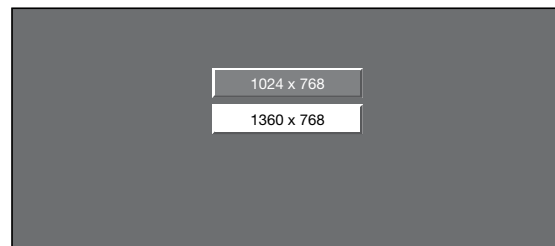

(Example)

NOTE

- You can only select the "Input Signal" on the Setup menu when receiving one of the 2 input signals listed above.

Connecting a PC

RS-232C port specifications

PC Control of the TV

- When a programme is set, the TV can be controlled from the PC using the RS-232C terminal. The input signal (PC/video) can be selected, the volume can be adjusted and various other adjustments and settings can be made, enabling automatic programmed playing.
- Use an RS-232C cable cross-type (commercially available) for the connections.

NOTE

- This operation system should be used by a person who is accustomed to using PCs.



RS-232C serial control cable
(cross type)

Communication conditions

Set the RS-232C communications settings on the PC to match the TV's communications conditions. The TV's communications settings are as follows:

Baud rate:	9,600 bps
Data length:	8 bits
Parity bit:	None
Stop bit:	1 bit
Flow control:	None

Communication procedure

Send the control commands from the PC via the RS-232C connector.

The TV operates according to the received command and sends a response message to the PC.

Do not send multiple commands at the same time. Wait until the PC receives the OK response before sending the next command.

Make sure to send "A" with the carriage return and confirm that "ERR" returns before operating.

Command format

Eight ASCII codes + CR

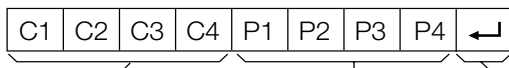

Command 4-digits Parameter 4-digits Return code

Command 4-digits: Command. The text of four characters.

Parameter 4-digits: Parameter 0 – 9, blank, ?

Parameter

Input the parameter values, aligning left, and fill with blank(s) for the remainder. (Be sure that four values are input for the parameter.)

When the input parameter is not within an adjustable range, "ERR" returns. (Refer to "Response code format".)

0			
---	--	--	--

0	0	0	9
---	---	---	---

-	3	0	
---	---	---	--

1	0	0	
---	---	---	--

0	0	5	5
---	---	---	---

When "?" is input for some commands, the present setting value responds.

?			
---	--	--	--

?	?	?	?
---	---	---	---

Response code format

Normal response

O	K	↵
---	---	---

Return code (ODH)

Problem response (communication error or incorrect command)

E	R	R	↵
---	---	---	---

Return code (ODH)

After sending the return code (ODH), make sure to send line feed (OAH) as well.

Connecting a PC

PC compatibility chart

Resolution		Horizontal Frequency	Vertical Frequency	Analogue (D-Sub)	Digital (HDMI)	VESA Standard
VGA	640 × 480	31.5 kHz	60 Hz	✓	✓	✓
SVGA	800 × 600	37.9 kHz	60 Hz	✓	✓	✓
XGA	1024 × 768	48.4 kHz	60 Hz	✓	✓	✓
WXGA	1360 × 768	47.7 kHz	60 Hz	✓	✓	✓
SXGA	1280 × 1024	64.0 kHz	60 Hz	✓	✓	✓
SXGA+	1400 × 1050	65.3 kHz	60 Hz		✓	✓

VGA, SVGA, XGA, WXGA, SXGA and SXGA+ are registered trademarks of International Business Machines Corporation.

NOTE





- This TV has only limited PC compatibility, correct operation can only be guaranteed if the video card conforms exactly to the VESA 60Hz standard. Any variations from this standard will result in picture distortions.

RS-232C command list

CONTROL ITEM	COMMAND	PARAMETER	CONTROL CONTENTS	CONTROL ITEM	COMMAND	PARAMETER	CONTROL CONTENTS
POWER SETTING	P O W R	0 _ _ _	POWER OFF	POSITION	H P O S	* * * _	H-POSITION (AV/PC)
INPUT SELECTION A	I T G D	_ _ _ _	INPUT SWITCHING (TOGGLE)		V P O S	* * * _	V-POSITION (AV/PC)
	I T V D	_ _ _ _	TV (CHANNEL FIXED)		C L C K	* * * _	CLOCK (0 - 180)
	I D T V	_ _ _ _	DTV (CHANNEL FIXED)		P H S E	* * _ _	PHASE (0 - 40)
	I A V D	* _ _ _	EXT1 - 8 (1 - 8)	W I D E	0 _ _ _	TOGGLE (AV)	
CHANNEL	D C C H	* * _ _	TV DIRECT CHANNEL (1 - 99)	W I D E	1 _ _ _	NORMAL (AV)	
	C H U P	_ _ _ _	CHANNEL UP	W I D E	2 _ _ _	ZOOM 14:9 (AV)	
	C H D W	_ _ _ _	CHANNEL DOWN	W I D E	3 _ _ _	PANORAMA (AV)	
	D T V D	* * * _	DTV DIRECT CHANNEL (1 to 999)	W I D E	4 _ _ _	FULL (AV)	
	D T U P	_ _ _ _	DTV CHANNEL UP	W I D E	5 _ _ _	CINEMA 16:9 (AV)	
	D T D W	_ _ _ _	DTV CHANNEL DOWN	W I D E	6 _ _ _	CINEMA 14:9 (AV)	
INPUT SELECTION B	I N P 1	0 _ _ _	EXT1 (Y/C)	W I D E	7 _ _ _	NORMAL (PC)	
	I N P 1	1 _ _ _	EXT1 (CVBS)	W I D E	8 _ _ _	CINEMA (PC)	
	I N P 1	2 _ _ _	EXT1 (RGB)	W I D E	9 _ _ _	FULL (PC)	
	I N P 2	0 _ _ _	EXT2 (Y/C)	W I D E	1 0 _ _	DOT by DOT (AV/PC)	
	I N P 2	1 _ _ _	EXT2 (CVBS)	W I D E	1 1 _ _	UNDERSCAN (AV)	
	I N P 2	2 _ _ _	EXT2 (RGB)	MUTE	M U T E	0 _ _ _	TOGGLE
	I N P 3	0 _ _ _	EXT3		M U T E	1 _ _ _	MUTE ON
	I N P 3	1 _ _ _	EXT3 (S-VIDEO)		M U T E	2 _ _ _	MUTE OFF
	I N P 3	2 _ _ _	EXT3 (VIDEO)	SURROUND	A C S U	0 _ _ _	SURROUND TOGGLE
AV MODE SELECTION	A V M D	0 _ _ _	TOGGLE		A C S U	1 _ _ _	SURROUND ON
	A V M D	1 _ _ _	STANDARD		A C S U	2 _ _ _	SURROUND OFF
	A V M D	2 _ _ _	MOVIE	AUDIO CHANGE	A C H A	_ _ _ _	TOGGLE
	A V M D	3 _ _ _	GAME		SLEEP TIMER	O F T M	0 _ _ _
	A V M D	4 _ _ _	USER	O F T M		1 _ _ _	SLEEP TIMER 30 MIN
	A V M D	5 _ _ _	DYNAMIC (Fixed)	O F T M		2 _ _ _	SLEEP TIMER 1 HOUR
	A V M D	6 _ _ _	DYNAMIC	O F T M		3 _ _ _	SLEEP TIMER 1 HOUR 30 MIN
	A V M D	7 _ _ _	PC	O F T M		4 _ _ _	SLEEP TIMER 2 HOUR
	A V M D	8 _ _ _	xxYCC	O F T M		5 _ _ _	SLEEP TIMER 2 HOUR 30 MIN
	A V M D	? ? ? ?	1 to 8	TEXT	T E X T	0 _ _ _	TEXT OFF
VOLUME	V O L M	* * _ _	VOLUME (0 - 60)		T E X T	1 _ _ _	TEXT ON (TOGGLE)
					D C P G	* * * _	DIRECT PAGE JUMP (100 - 899)

Appendix

Troubleshooting

Problem	Possible Solution
<ul style="list-style-type: none"> No power. 	<ul style="list-style-type: none"> Check if you pressed  on the remote control unit. If the indicator on the TV lights up red, press . Is the AC cord disconnected? Check if you pressed  on the TV.
<ul style="list-style-type: none"> Unit cannot be operated. 	<ul style="list-style-type: none"> External influences such as lightning, static electricity, etc., may cause improper operation. In this case, operate the unit after first turning the power off, or unplugging the AC cord and re-plugging it in after 1 or 2 minutes.
<ul style="list-style-type: none"> Remote control unit does not operate. 	<ul style="list-style-type: none"> Are batteries inserted with polarity (+, -) aligned? Are batteries worn out? (Replace with new batteries.) Are you using it under strong or fluorescent lighting? Is a fluorescent light illuminated onto the remote control sensor?
<ul style="list-style-type: none"> Picture is cut off. 	<ul style="list-style-type: none"> Is the image position correct? Are screen mode adjustments (WIDE MODE) such as picture size made correctly? (Pages 29 and 33)
<ul style="list-style-type: none"> Strange colour, light colour, or dark, or colour misalignment. 	<ul style="list-style-type: none"> Adjust the picture tone. Is the room too bright? The picture may look dark in a room that is too bright. Check the colour system setting. (Pages 27 and 32)
<ul style="list-style-type: none"> Power is suddenly turned off. 	<ul style="list-style-type: none"> The unit's internal temperature has increased. Remove any objects blocking the vent or clean. Is the sleep timer set? Select "Off" from the "Sleep Timer" menu. (Page 26) Is "No signal off" activated?
<ul style="list-style-type: none"> No picture. 	<ul style="list-style-type: none"> Are connections to external equipment correct? (Pages 15-17) Is the input signal type selected correctly after connection? (Page 32) Is the correct input source selected? (Page 10) Is a non-compatible signal being input? (Page 36) Is the picture adjustment correct? (Pages 24-25) Is the antenna connected properly? (Page 8) Is "On" selected in "Audio Only"? (Page 30)
<ul style="list-style-type: none"> No sound. 	<ul style="list-style-type: none"> Is the volume too low? Make sure that headphones are not connected. Check if you pressed  on the remote control unit.
<ul style="list-style-type: none"> The TV sometimes makes a cracking sound. 	<ul style="list-style-type: none"> This is not a malfunction. This happens when the cabinet slightly expands and contracts according to change in temperature. This does not affect the TV's performance.

Cautions regarding use in high and low temperature environments

- When the unit is used in a low temperature space (e.g. room, office), the picture may leave trails or appear slightly delayed. This is not a malfunction, and the unit will recover when the temperature returns to normal.
 - Do not leave the unit in a hot or cold location. Also, do not leave the unit in a location exposed to direct sunlight or near a heater, as this may cause the cabinet to deform and the LCD panel to malfunction.
- Storage temperature: +5°C to +35°C.

Information on the software license for this product

Software composition

The software included in this product is comprised of various software components whose individual copyrights are held by SHARP or by third parties.

Software developed by SHARP and open source software

The copyrights for the software components and various relevant documents included with this product that were developed or written by SHARP are owned by SHARP and are protected by the Copyright Act, international treaties, and other relevant laws. This product also makes use of freely distributed software and software components whose copyrights are held by third parties. These include software components covered by a GNU General Public License (hereafter GPL), a GNU Lesser General Public License (hereafter LGPL) or other license agreement.

Obtaining source code

Some of the open source software licensors require the distributor to provide the source code with the executable software components. GPL and LGPL include similar requirements. For information on obtaining the source code for the open source software and for obtaining the GPL, LGPL, and other license agreement information, visit the following website:

<http://www.sharp-eu.com/gpl/>

We are unable to answer any questions about the source code for the open source software. The source code for the software components whose copyrights are held by SHARP is not distributed.

Acknowledgements

The following open source software components are included in this product:

- linux kernel • modutils • glibc • zlib • libpng

Updating your TV via DVB-T

To ensure that your TV software version is always up to date, from time to time SHARP will make updated TV base software and DVB software available.

Digital Setup Download Setup

Searching for updates*

* The country except UK and Sweden is set to “Yes” on this function.

The TV automatically determines whether a new software version is available when the TV is in standby mode.

Item

Yes: Search automatically if there is software available for update when the TV is in standby mode.

No: Do not search for update information.

Now: Check whether or not there is a new software immediately.

NOTE

- The TV must remain in standby mode for download. Do not switch off the TV with the main power switch.
- Updating the software may take some time.

Downloading the software

If the software is updated, the confirmation message “New download information has been detected.” appears. You can select the method of update.

- 1 When you tune to the service that provides the update, a confirmation message displays.
- 2 Follow the screen prompts.

Item

Yes: Start downloading immediately. It takes approximately one hour to update. You cannot carry out other operations while downloading.

No: Start downloading automatically several minutes after entering standby mode. The Timer settings will be executed.

- Cancel the download by pressing **OK** on the remote control when displaying “Discontinue” on the screen during the update.

Information Message List

When software is detected in the “Download Setup” menu and “No” is selected, you can update the software from the “Message List” menu.

Press **◀/▶** to select “Yes” after confirming the message, and then press **OK**.

NOTE

- When the TV succeeds at downloading new software, the message is updated in the “Message List” of the “Information” menu.
- The software update will not be carried out if there is no new software available at the specified download time.

Information Receiver Report

Display reports regarding failures and changes for timer settings.

Reset

If complex adjustments are made so that the settings cannot be restored to normal, you can reset the settings to the factory preset values.

Setup Reset

- 1 Press **◀/▶** to select “Yes”, and then press **OK**.
 - “Now, TV will restart automatically. OK?” displays on the screen.
- 2 Press **◀/▶** to select “Yes”, and then press **OK**.
 - “Now initialising...” displays on the screen and blinks.
 - After the reset has completed, the power shuts off and then comes back on. The screen will have returned to its original settings.

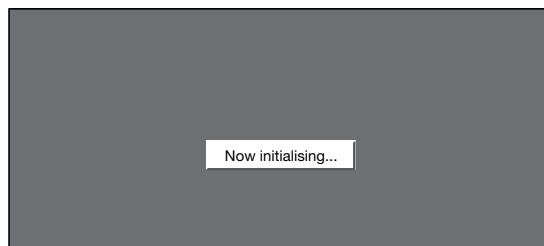

Identification

Setup Identification

You can check the TV ID on the screen for reporting to customer service.

CLEARING THE PASSWORD

- 1 Go to MENU > Setup.
- 2 Press **▲/▼** to select “Auto Installation”, “Programme Setup”, “Child Lock”, “Reset”, and the PIN input screen displays.

- - - -
- 3 Press and hold both **CH ▲** and **VOL +** on the TV simultaneously until the message appears on the screen.

Appendix

Specifications

Item		42" LCD COLOUR TV, Model: LC-42B20E, LC-42B20S, LC-42G20E, LC-42G20S	
LCD panel		42" Advanced Super View & BLACK TFT LCD	
Number of dots		6,220,800 dots (1920 × 1080 × 3 dots)	
Video Colour System		PAL/SECAM/NTSC 3.58/NTSC 4.43/PAL 60	
TV Function	TV-Standard	Analogue	CCIR (B/G, I, D/K, L/L')
		Digital	DVB-T (2K/8K OFDM)
	Receiving Channel	VHF/UHF	E2-E69ch, F2-F10ch, I21-I69ch, IR A-IR Jch (Digital: E5-E69ch)
		CATV	Hyper-band, S1-S41ch
	TV-Tuning System	Auto Preset 999 ch (ATV: 99 ch), Auto Label, Auto Sort	
STEREO/BILINGUAL		NICAM/A2	
Brightness		450 cd/m ²	
Backlight life		60,000 hours (at Backlight Standard position)	
Viewing angles		H : 176° V : 176°	
Audio amplifier		15W × 2	
Speaker		(40 mm × 100 mm) × 4	
Terminals	Antenna	UHF/VHF 75 Ω Din type (Analogue & Digital)	
	RS-232C	D-Sub 9 pin male connector	
	EXT 1	SCART (AV input, Y/C input, RGB input, TV output)	
	EXT 2	SCART (AV input/monitor output, Y/C input, AV Link, RGB input)	
	EXT 3	S-VIDEO (Y/C input), RCA pin (AV input)	
	EXT 4	HDMI	
	EXT 5	HDMI	
	EXT 6	HDMI, Ø 3.5 mm jack	
	EXT 7	15 pin mini D-sub, Ø 3.5 mm jack	
	EXT 8	COMPONENT IN: Y/Pb(Cb)/Pr(Cr), RCA pin (L/R)	
	DIGITAL AUDIO OUTPUT	Optical SPDIF Digital audio output	
	C. I. (Common Interface)	EN50221, R206001	
	OUTPUT	RCA pin (Audio)	
	Headphones	Ø 3.5mm jack (Audio output)	
OSD language		Czech, Danish, Dutch, English, Estonian, Finnish, French, German, Greek, Hungarian, Italian, Latvian, Lithuanian, Norwegian, Polish, Portuguese, Russian, Slovak, Slovene, Spanish, Swedish, Turkish	
Power Requirement		AC 220-240 V, 50 Hz	
Power Consumption		208W (0.5 W Standby) (Method IEC60107)	
Weight		21.5 kg (Without stand), 26.0 kg (With stand)	
Operating temperature		0°C to +40°C	

- As a part of policy of continuous improvement, SHARP reserves the right to make design and specification changes for product improvement without prior notice. The performance specification figures indicated are nominal values of production units. There may be some deviations from these values in individual units.

NOTE

- Refer to the inside back cover for dimensional drawings.

Optional accessory

The listed optional accessories are available for the LCD colour TVs. Please purchase them at your nearest shop.

- Additional optional accessories may be available in the near future. When purchasing, please read the newest catalogue for compatibility and check the availability.

No.	Part name	Part number
1	Wall mount bracket	AN-52AG4



A. Information on Disposal for Users (private households)

1. In the European Union

Attention: If you want to dispose of this equipment, please do not use the ordinary dust bin!

Used electrical and electronic equipment must be treated separately and in accordance with legislation that requires proper treatment, recovery and recycling of used electrical and electronic equipment. Following the implementation by member states, private households within the EU states may return their used electrical and electronic equipment to designated collection facilities free of charge*. In some countries* your local retailer may also take back your old product free of charge if you purchase a similar new one.
*) Please contact your local authority for further details.

If your used electrical or electronic equipment has batteries or accumulators, please dispose of these separately beforehand according to local requirements.

By disposing of this product correctly you will help ensure that the waste undergoes the necessary treatment, recovery and recycling and thus prevent potential negative effects on the environment and human health which could otherwise arise due to inappropriate waste handling.

2. In other Countries outside the EU

If you wish to discard this product, please contact your local authorities and ask for the correct method of disposal.

For Switzerland: Used electrical or electronic equipment can be returned free of charge to the dealer, even if you don't purchase a new product. Further collection facilities are listed on the homepage of www.swico.ch or www.sens.ch.

B. Information on Disposal for Business Users

1. In the European Union

If the product is used for business purposes and you want to discard it:

Please contact your SHARP dealer who will inform you about the take-back of the product. You might be charged for the costs arising from take-back and recycling. Small products (and small amounts) might be taken back by your local collection facilities.

For Spain: Please contact the established collection system or your local authority for take-back of your used products.

2. In other Countries outside the EU

If you wish to discard of this product, please contact your local authorities and ask for the correct method of disposal.

Rating table for Child Lock

Broadcasted rating / User-adjusted rating	AGE															
	4	5	6	7	8	9	10	11	12	13	14	15	16	17	18	
Universal viewing	✓	–	–	–	–	–	–	–	–	–	–	–	–	–	–	
Parental approval pref.	✓	✓	✓	✓	✓	–	–	–	–	–	–	–	–	–	–	
X-rated	✓	✓	✓	✓	✓	✓	✓	✓	✓	✓	✓	✓	✓	✓	✓	

Broadcasted rating / User-adjusted rating	Universal viewing	Parental approval pref.	X-rated
Universal viewing	–	–	–
Parental approval pref.	✓	–	–
X-rated	✓	✓	–

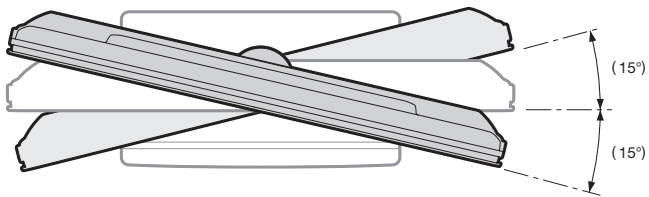
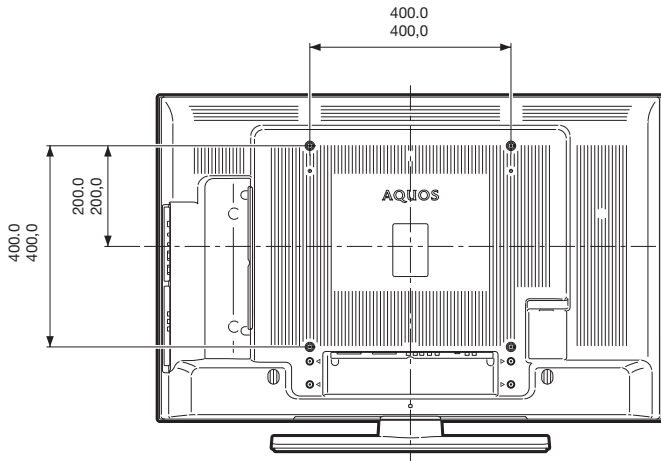
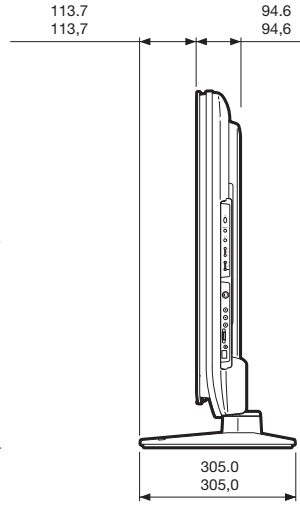
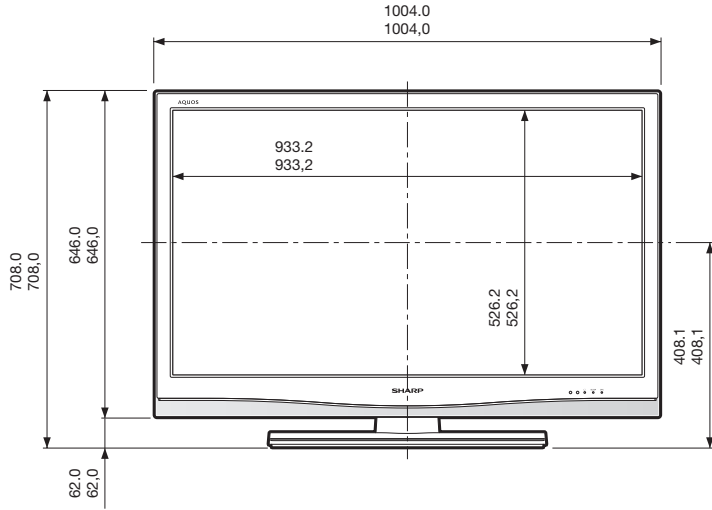
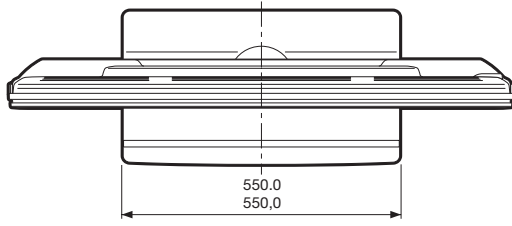

SHARP®

SHARP ELECTRONICS (Europe) GmbH

SonninstraÙe 3, D-20097 Hamburg

SHARP CORPORATION

Printed on environmentally friendly paper
Auf ökologischem Papier gedruckt
Imprimé sur papier écologique
Stampato su carta ecologica
Afgedrukt op ecologisch papier
Impreso en papel ecológico



Printed in Poland
Gedruckt in Polen
Imprimé en Pologne
Stampato in Polonia
Gedruckt in Polen
Impreso en Polonia

PIN

--	--	--	--

TINS-D435WJZZ
07P12-PL-NG