

SHARP®

**LC-13E1E
LC-15E1E
LC-20E1E**

**LCD COLOUR TELEVISION
LCD-FARBFERNSEHGERÄT
TÉLÉVISION COULEUR À ÉCRAN
À CRISTAUX LIQUIDES (LCD)
TELEVISORE A COLORI LCD
TELEVISIÓN EN COLOR LCD
LCD-FÄRG-TV
LCD-KLEURENTELEVISIE**

AQUOS



**OPERATION MANUAL
BEDIENUNGSANLEITUNG
MODE D'EMPLOI
MANUALE DI ISTRUZIONI
MANUAL DE MANEJO
BRUKSANVISNING
GEBRUIKSAANWIJZING**

ENGLISH

DEUTSCH

FRANÇAIS

ITALIANO

ESPAÑOL

SVENSKA

NEDERLANDS

This equipment complies with the requirements of Directive 89/336/EEC and 73/23/EEC as amended by 93/68/EEC.

Dieses Gerät entspricht den Anforderungen der EG-Richtlinien 89/336/EWG und 73/23/EWG mit Änderung 93/68/EWG.

Ce matériel répond aux exigences contenues dans les directives 89/336/CEE et 73/23/CEE modifiées par la directive 93/68/CEE.

Dit apparaat voldoet aan de eisen van de richtlijnen 89/336/EEG en 73/23/EEG, gewijzigd door 93/68/EEG.

Dette udstyr overholder kravene i direktiv nr. 89/336/EEC og 73/23/EEC med tillæg nr. 93/68/EEC.

Quest'apparecchio è conforme ai requisiti delle direttive 89/336/EEC e 73/23/EEC come emendata dalla direttiva 93/68/EEC.

Η εγκατάσταση αυτή ανταποκρίνεται στις απαιτήσεις των οδηγιών της Ευρωπαϊκής Ένωσης 89/336/ΕΟΚ και 73/23/ΕΟΚ, όπως οι κανονισμοί αυτοί συμπληρώθηκαν από την οδηγία 93/68/ΕΟΚ.

Este equipamento obedece às exigências das directivas 89/336/CEE e 73/23/CEE, na sua versão corrigida pela directiva 93/68/CEE.



Este aparato satisface las exigencias de las Directivas 89/336/CEE y 73/23/CEE, modificadas por medio de la 93/68/CEE.

Denna utrustning uppfyller kraven enligt riktlinjerna 89/336/EEC och 73/23/EEC så som kompletteras av 93/68/EEC.

Dette produktet oppfyller betingelsene i direktivene 89/336/EEC og 73/23/EEC i endringen 93/68/EEC.

Tämä laite täyttää direktiivien 89/336/EEC ja 73/23/EEC vaatimukset, joita on muutettu direktiivillä 93/68/EEC.

SPECIAL NOTE FOR USERS IN THE U.K.

The mains lead of this product is fitted with a non-rewireable (moulded) plug incorporating a 3A fuse. Should the fuse need to be replaced, a BSI or ASTA approved BS 1362 fuse marked  or  and of the same rating as above, which is also indicated on the pin face of the plug, must be used. Always refit the fuse cover after replacing the fuse. Never use the plug without the fuse cover fitted. In the unlikely event of the socket outlet in your home not being compatible with the plug supplied, cut off the mains plug and fit an appropriate type.

DANGER: The fuse from the cut-off plug should be removed and the cut-off plug destroyed immediately and disposed of in a safe manner.

Under no circumstances should the cut-off plug be inserted elsewhere into a 13A socket outlet, as a serious electric shock may occur.

To fit an appropriate plug to the mains lead, follow the instructions below:

IMPORTANT: The wires in the mains lead are coloured in accordance with the following code:

Blue : Neutral Brown : Live

As the colours of the wires in the mains lead of this product may not correspond with the coloured markings identifying the terminals in your plug, proceed as follows;

- The wire which is coloured blue must be connected to the plug terminal which is marked N or coloured black.
- The wire which is coloured brown must be connected to the plug terminal which is marked L or coloured red.

Ensure that neither the brown nor the blue wire is connected to the earth terminal in your three-pin plug. Before replacing the plug cover make sure that:

- If the new fitted plug contains a fuse, its value is the same as that removed from the cut-off plug.
- The cord grip is clamped over the sheath of the mains lead, and not simply over the lead wires.

IF YOU HAVE ANY DOUBT, CONSULT A QUALIFIED ELECTRICIAN.

LC-13E1E

LC-15E1E

LC-20E1E

LCD COLOUR TELEVISION

ENGLISH

OPERATION MANUAL

Contents

	Page		Page
Dear SHARP Customer	2	Adjusting Sound Settings	18
Important Safety Precautions	2	Hi-fi Sound Settings	19
Supplied Accessories	4	Using Programme Table	19
Preparation	5	Programmes	20
Installing Batteries in the Remote Control	5	Features	26
Using Remote Control	5	On-screen Display	28
Power Connection	6	Child Lock	29
Antenna Connection	6	AV Connections	34
First Installation	7	Timer Functions	36
Part Names of Main Unit	9	NICAM Broadcast Selection	37
Part Names of Remote Control	11	IGR (German stereo system) Broadcasts	38
Basic Operation	12	Teletext	39
Turning On and Off the Main Power	12	Connecting External Devices	43
Switching the TV/VIDEO (AV1/AV2/TV) Mode	12	Examples of external devices that can be	
Sound Volume	13	connected	43
ON/OFF Standby	13	21-pin Euro-SCART (RGB)	44
Changing Channels	14	How to fix the cables	46
Selecting Menu Items	15	Troubleshooting	47
Useful Features	17	Specifications	49
Adjusting Picture Settings	17	Dimensional Drawings	50

Dear SHARP Customer

Thank you for your purchase of the SHARP LCD Colour TV product. To ensure safety and many years of trouble-free operation of your product, please read the Important Safety Precautions carefully before using this product.

Important Safety Precautions

Electricity is used to perform many useful functions, but it can also cause personal injuries and property damage if improperly handled. This product has been engineered and manufactured with the highest priority on safety. However, improper use can result in electric shock and/or fire. In order to prevent potential danger, please observe the following instructions when installing, operating and cleaning the product. To ensure your safety and prolong the service life of your LCD colour TV product, please read the following precautions carefully before using the product.

- **Read instructions**—All operating instructions must be read and understood before the product is operated.
- **Keep this manual in a safe place**—These safety and operating instructions must be kept in a safe place for future reference.
- **Observe warnings**—All warnings on the product and in the instructions must be observed closely.
- **Follow instructions**—All operating instructions must be followed.
- **Attachments**—Do not use attachments not recommended by the manufacturer. Use of inadequate attachments can result in accidents.
- **Power source**—This product must operate on a power source specified on the specification label. If you are not sure of the type of power supply used in your home, consult your dealer or local power company. For units designed to operate on batteries or another power source, refer to the operating instructions.
- **Power cord protection**—The power cords must be routed properly to prevent people from stepping on them or objects from resting on them. Check the cords at the plugs and product.
- **If you plan to use a DC power supply unit other than the AC adapter supplied with the product**, make sure the power supply unit provides stable voltage with minimum fluctuations. Unstable power supply can cause problems in the product.
- **Overloading**—Do not overload AC outlets or extension cords. Overloading can cause fire or electric shock.
- **Entering of objects and liquids**—Never insert an object into the product through vents or openings. High voltage flows in the product, and inserting an object can cause electric shock and/or short internal parts. For the same reason, do not spill water or liquid on the product.
- **Servicing**—Do not attempt to service the product yourself. Removing covers can expose you to high voltage and other dangerous conditions. Request a qualified service person to perform servicing.
- **Repair**—If any of the following conditions occurs, unplug the power cord from the AC outlet, and request a qualified service person to perform repairs:
 - a. When the power cord or plug is damaged.
 - b. When a liquid was spilled on the product or when objects have fallen into the product.
 - c. When the product has been exposed to rain or water.
 - d. When the product does not operate properly as described in the operating instructions.

Do not touch the controls other than those described in the operating instructions. Improper adjustment of controls not described in the instructions can cause damage, which often requires extensive adjustment work by a qualified technician.
 - e. When the product has been dropped or damaged.
 - f. When the product displays an abnormal condition. Any noticeable abnormality in the product indicates that the product needs servicing.
- **Replacement parts**—In case the product needs replacement parts, make sure that the service person uses replacement parts specified by the manufacturer, or those with the same characteristics and performance as the original parts. Use of unauthorized parts can result in fire, electric shock and/or other danger.
- **Safety checks**—Upon completion of service or repair work, request the service technician to perform safety checks to ensure that the product is in proper operating condition.
- **Wall or ceiling mounting**—When mounting the product on a wall or ceiling, be sure to install the product according to the method recommended by the manufacturer.

Important Safety Precautions (Continued)

- **Cleaning**—Unplug the power cord from the AC outlet before cleaning the product. Use a damp cloth to clean the product. Do not use liquid cleaners or aerosol cleaners.

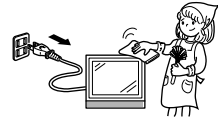

- **Water and moisture**—Do not use the product near water, such as bathtub, washbasin, kitchen sink and laundry tub, swimming pool and in a wet basement.



- **Stand**—Do not place the product on an unstable cart, stand, tripod or table. Placing the product on an unstable base can cause the product to fall, resulting in serious personal injuries as well as damage to the product. Use only a cart, stand, tripod, bracket or table recommended by the manufacturer or sold with the product. When mounting the product on a wall, be sure to follow the manufacturer's instructions. Use only the mounting hardware recommended by the manufacturer.



- When relocating the product placed on a cart, it must be moved with utmost care. Sudden stops, excessive force and uneven floor surface can cause the product to fall from the cart.



- **Ventilation**—The vents and other openings in the cabinet are designed for ventilation. Do not cover or block these vents and openings since insufficient ventilation can cause overheating and/or shorten the life of the product. Do not place the product on a bed, sofa, rug or other similar surface, since they can block ventilation openings. This product is not designed for built-in installation; do not place the product in an enclosed place such as a bookcase or rack, unless proper ventilation is provided or the manufacturer's instructions are followed.



- The LCD panel used in this product is made of glass. Therefore, it can break when the product is dropped or applied with impact. Be careful not to be injured by broken glass pieces in case the LCD panel breaks.

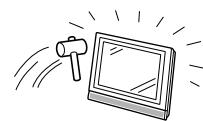



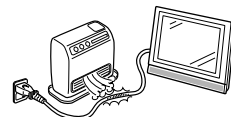

- **Heat sources**—Keep the product away from heat sources such as radiators, heaters, stoves and other heat-generating products (including amplifiers).

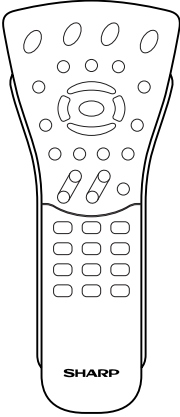

The LCD panel is a very high technology product with 921,600 thin film transistors, giving you fine picture details. Occasionally, a few non-active pixels may appear on the screen as a fixed point of blue, green or red. Please note that this does not affect the performance of your product.

Supplied Accessories

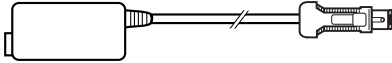
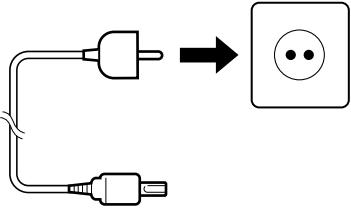
Make sure the following accessories are provided with the product.

<p>Wireless remote control (×1)</p> 	<p>R-03 ("AAA" size, UM/SUM-4) dry battery (×2)</p> 
<p>AC adapter (×1)</p>	<p>AC cord (×1)</p>
	 <p>* Product shape varies in some countries.</p>
<p>Cable clamp (×1)</p>	<p>Operation manual (×1)</p>
	

Preparation

Installing Batteries in the Remote Control

Before using the LCD TV set for the first time, install the two R-03 ("AAA" size, UM/SUM-4) batteries supplied in the remote control. When the batteries become depleted and the remote control fails to operate, replace the batteries with new R-03 ("AAA" size, UM/SUM-4) batteries.

1 Open the battery cover.

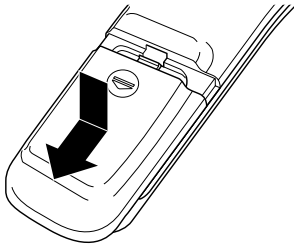

■ Slide the cover while pressing the (▼) part.

2 Insert two R-03 ("AAA" size, UM/SUM-4) batteries.

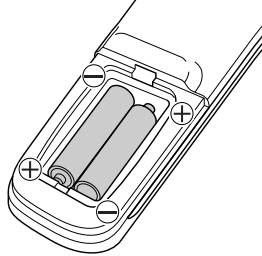

■ Position the positive and negative ends of the batteries as indicated in the compartment.

3 Replace the battery cover.

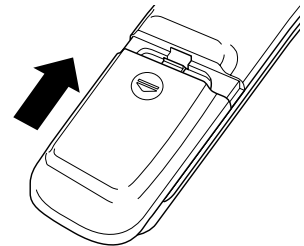

■ Engaging the lower claw with the remote control, close the cover.

⚠ Caution!

Precautions regarding batteries

■ Improper use of batteries can result in a leakage of chemicals and/or explosion. Be sure to follow the instructions below.

- Place batteries with their terminals corresponding to the (+) and (-) indications.
- Different types of batteries have different characteristics. Do not mix batteries of different types.
- Do not mix old and new batteries. Mixing old and new batteries can shorten the life of new batteries and/or cause old batteries to leak chemicals.
- Remove batteries as soon as they are depleted. Chemicals that leak from batteries can cause a rash. If chemical leakage is found, wipe it off with a cloth.
- The batteries supplied with the product may have a shorter life expectancy due to storage conditions.
- If the remote control is not to be used for an extended period of time, remove the batteries from the remote control.

Using Remote Control

■ Use the remote control by pointing it towards the remote sensor window of the main unit. Objects between the remote control and sensor window may prevent proper operation.

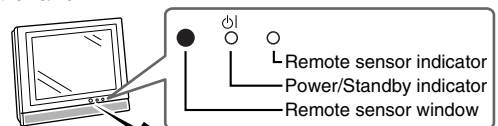

Cautions regarding use of remote control

- Do not expose the remote control to shock. In addition, do not expose the remote control to liquids, and do not place it in an area with high humidity.
- Do not install or place the remote control under direct sunlight. The heat may cause deformation of the unit.
- The remote control may not work properly if the remote sensor window is under direct sunlight or strong lighting. In such a case, change the angle of the lighting or main unit, or operate the remote control closer to the remote sensor window.

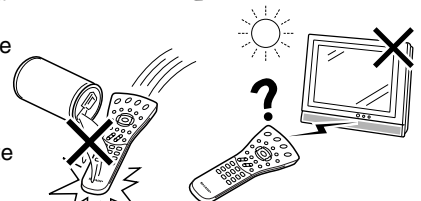

Preparation (Continued)

Power Connection

Connect to the DC input terminal of the product.

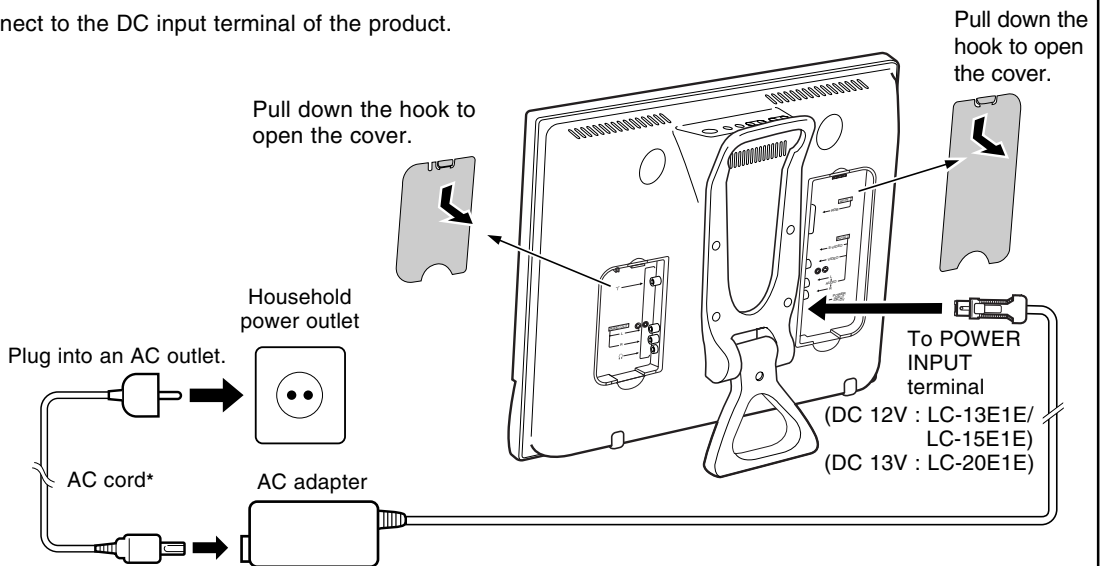

Note:

* Product shape varies in some countries.

- Always turn the **MAIN POWER (Φ)** switch of the LCD TV set to OFF when connecting the AC adapter.
- Unplug the AC adapter from the LCD TV set and power outlet when the LCD TV set is not to be used for a long period of time.

Antenna Connection

To enjoy a clearer picture, we recommend that you use an outdoor antenna. The following is a brief explanation of the types of connection that are used for coaxial and feeder cables:

- (1) If your outdoor antenna uses a 75-ohm coaxial cable, change this for a new standard DIN45325 (IEC169-2) plug and plug it into the antenna terminal at the back of TV set via the antenna cable (not supplied).
- (2) If your outdoor antenna uses a 300-ohm twin-lead flat feeder, change this for a 300-ohm to 75-ohm impedance converter and plug it into the antenna terminal at the back of TV set via the antenna cable (not supplied).

75-ohm coaxial cable (round cable)



300-ohm twin-lead flat feeder

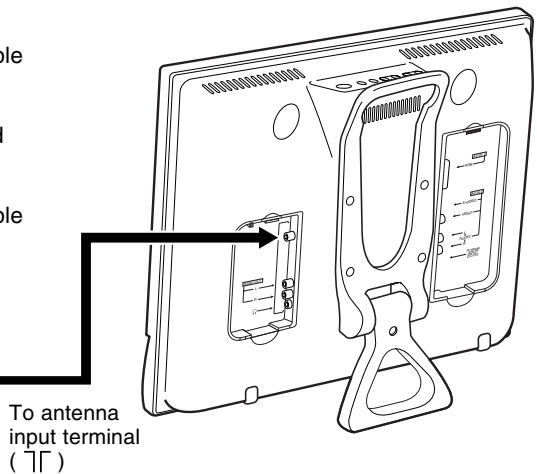

To antenna input terminal (Γ)

First Installation

When you turn on the LCD TV set for the first time, the First Installation routine, which makes installation easier, is activated. Using this routine, you can select the on-screen display language, and automatically search for and store all the receivable channels.

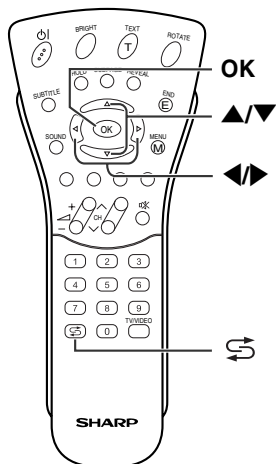
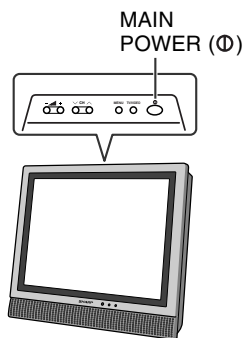

1 Press the **MAIN POWER (Ⓞ)** switch. The “First installation (Language)” screen with a list of the languages for the on-screen display appears.



2 Press **▲/▼** to select the desired language, and then press **OK**. The “First installation (Automatic search)” screen appears in the language selected.

Note:

- You can change the on-screen display language after the First Installation routine by selecting “Language” on the TV menu (see pages 15 and 16).

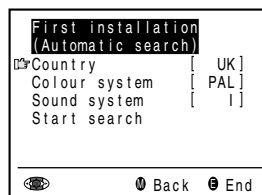

3 Press **▲/▼** to select the desired adjustment item, and then press **OK**. Then press **◀/▶** to select the desired item.

4 Press **▲/▼** to select “Start search.”

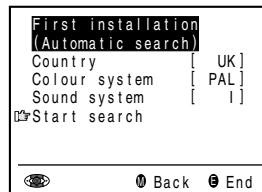

Note:

- AV1 is automatically switched to, when “First installation” is selected. If you selected “First installation”, and want to return to the previous screen, press **Flashback (↶)**.

First Installation (Continued)

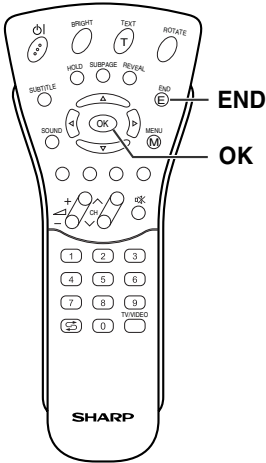

- 5** Press **OK** to begin the automatic programme search.

Start search		
42.25MHz	PAL-I	
0	8	16
1	9	17
2	10	18
3	11	19
4	12	20
5	13	21
6	14	22
7	15	23

⏏ Cancel

When the search is completed, the new programmes found are displayed in yellow on the programme list.

Start search		
Search is completed		
0	8	16
1	S06	9
2	S08	10
3	S10	11
4	S11	12
5	E03	13
6	E05	14
7	E06	15

⏏ End

- 6** Press **END** to exit.

Part Names of Main Unit

Controls

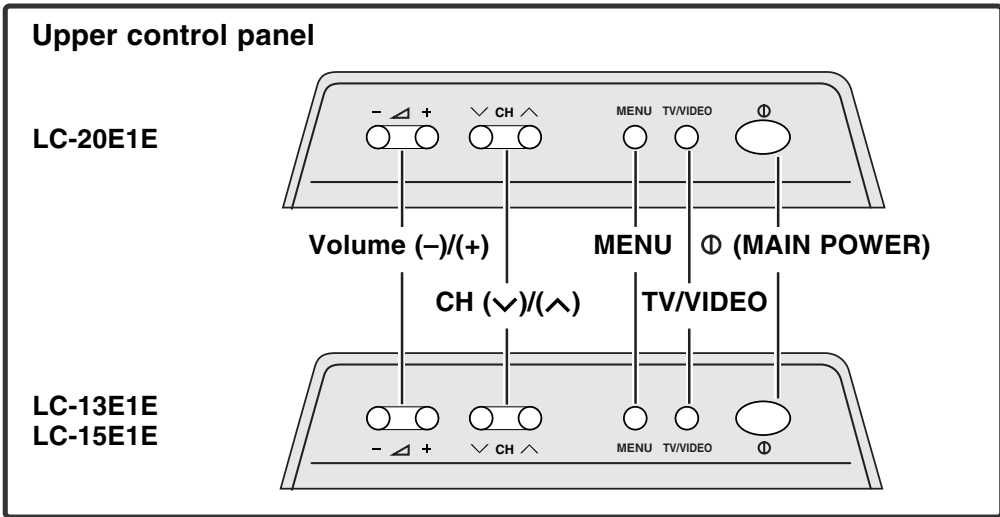

The screen can be adjusted backwards to an angle between 12 degrees and 35 degrees. The screen cannot be set up straight. When changing the angle, make sure to hold the stand and adjust the screen to the best viewable angle.

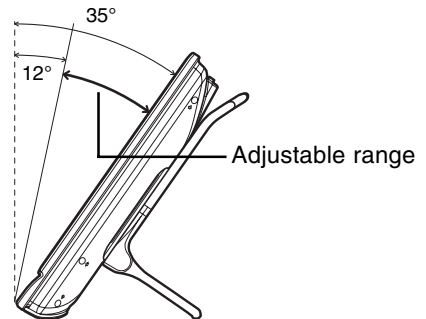

Remote sensor indicator

A red indicator blinks when the TV set receives the remote control signal.

POWER/STANDBY indicator

A green indicator lights when the power is on and a red indicator lights when in the standby mode (the indicator will not light when the main power is off).

Note:

- TV/VIDEO, CH(v)/(^), Volume (-)/(+) and MENU on the main unit have the same functions as the same buttons on the remote control. Fundamentally, this operation manual provides a description based on operation using the remote control.
- The LC-13E1E, LC-15E1E and LC-20E1E have different external dimensions and the positions where the names of the buttons are displayed also differ but the same operating procedures are followed for all three models.

Part Names of Main Unit (Continued)

Terminals

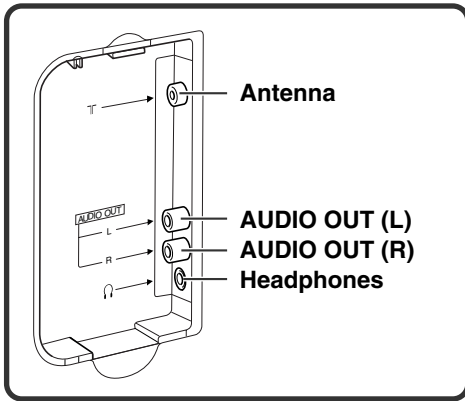

Rear view

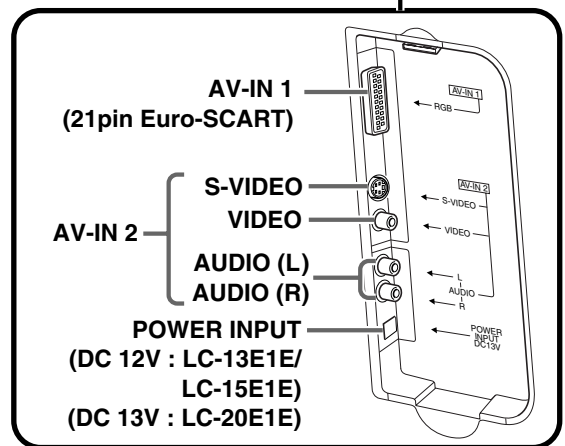
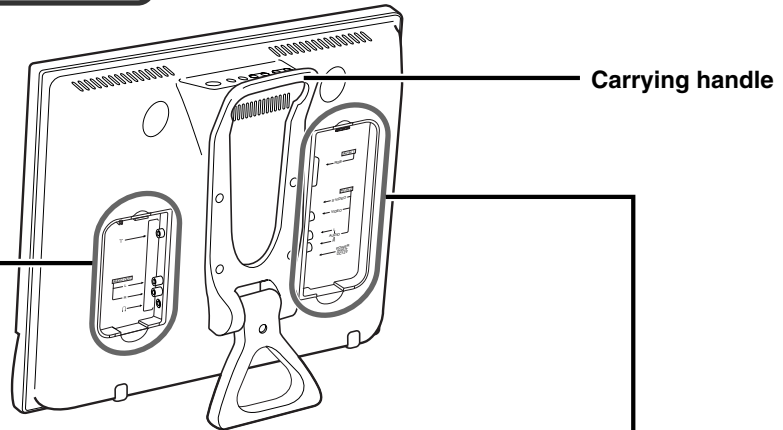

Part Names of Remote Control

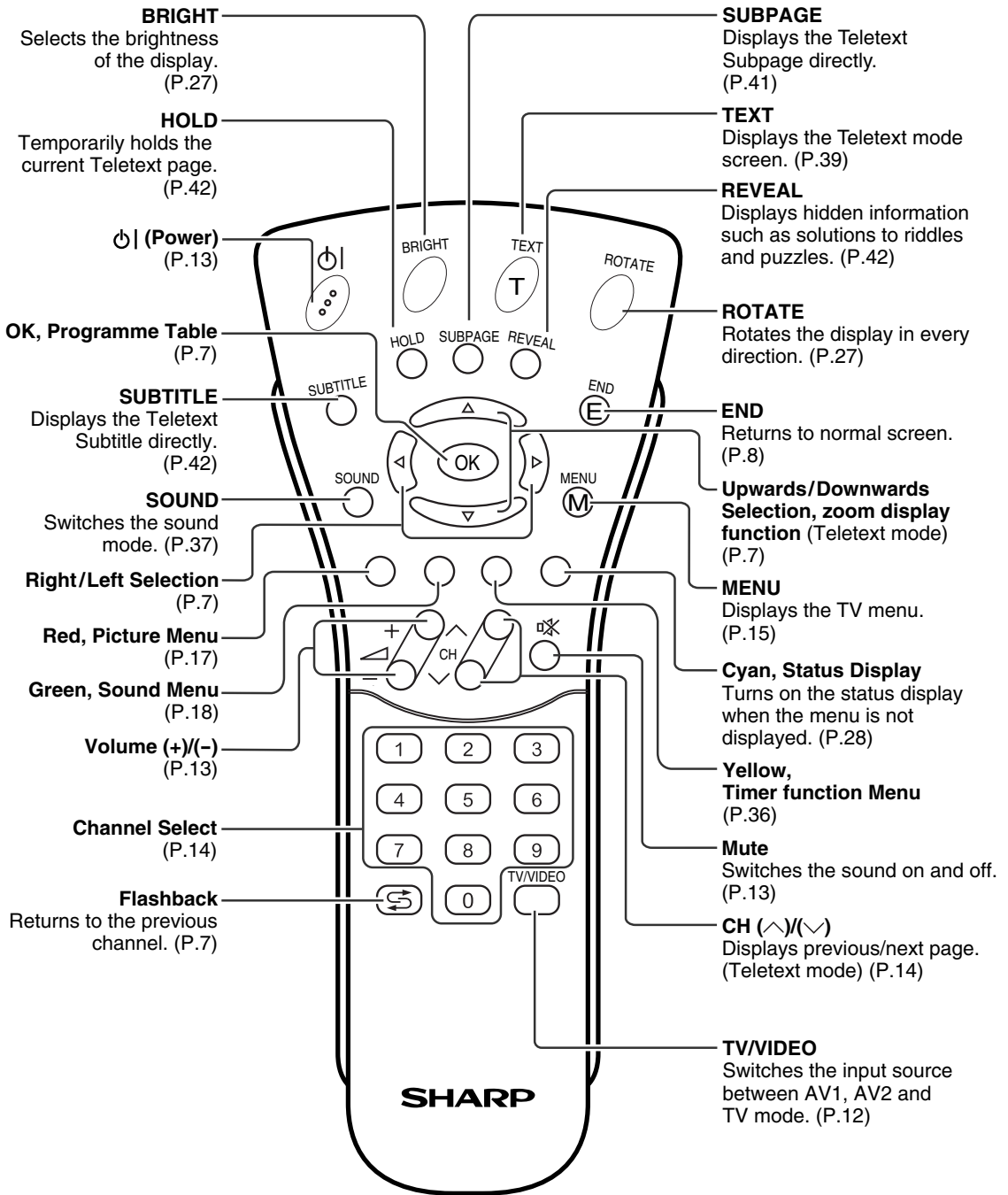

Basic Operation

Turning On and Off the Main Power

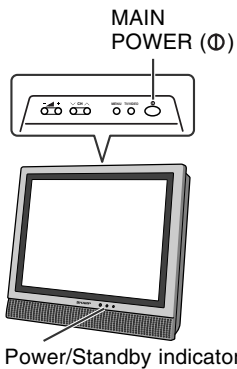

- Press the **MAIN POWER (Ⓞ)** switch. The power/standby indicator instantaneously changes from red to green and the main unit is turned on.

Note:

- The On-screen indicator disappears after a few seconds.
- To turn off the main power, press the **MAIN POWER (Ⓞ)** switch.

On-screen display

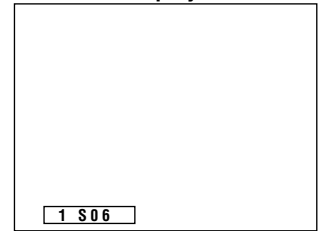

Switching the TV/VIDEO (AV1/AV2/TV) Mode

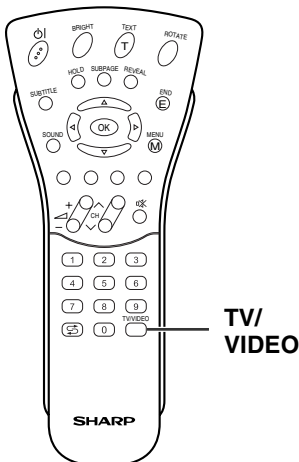

- 1 Turn on the power of the connected video equipment.
- 2 Press **TV/VIDEO** to select the applicable input source. The screen displays AV1, AV2 or TV mode each time **TV/VIDEO** is pressed.

Note:

- About the video modes
 - AV1: Select this when viewing the signals from the video equipment connected to the AV-IN 1 terminal.
 - AV2: Select this when viewing the signals from the video equipment connected to the AV-IN 2 terminals using the VIDEO or S-VIDEO terminal for video input.
- If both VIDEO and S-VIDEO terminals are connected with cables, the S-VIDEO input terminal is selected as the high priority.

AV1 mode

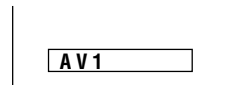

AV2 mode

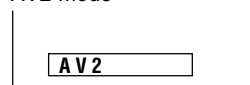

TV mode

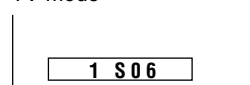

Sound Volume

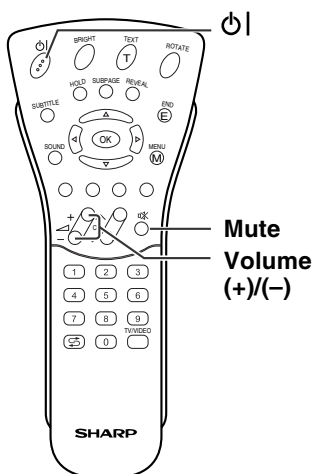

To adjust the volume

- Press **Volume (+)** to increase the sound volume. The numerical value increases.

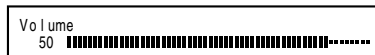

- Press **Volume (-)** to decrease the sound volume. The numerical value decreases.

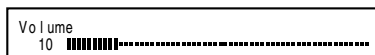

To mute the sound

- Press **Mute** to temporarily turn off the sound. "Sound off" is displayed.
- Press **Mute** to turn off the Mute function. "Sound on" is displayed.



Note:

- When **Volume (+)/(-)** is pressed in the Mute mode, the sound turns on and the volume indicator is displayed.
- The Mute function is cancelled when **Power** is pressed.

ON/OFF Standby

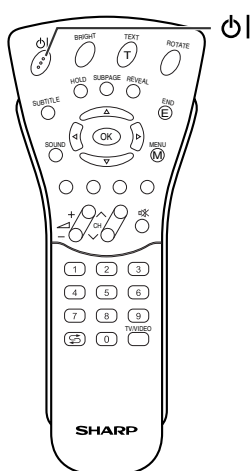

To turn off the LCD TV

Press **Power**. The power/standby indicator will turn red.

To turn the LCD TV back on

Press **Power** again. The power/standby indicator will turn green.

Basic Operation (Continued)

Changing Channels

You can select channels using **Channel Select** or **CH (^)/(v)**.

- To handle the increasing number of channels available, this LCD TV set allows you to select up to 200 channels (0 to 199).

Using Channel Select

When selecting the channel using **Channel Select**, finish inputting the channel number by holding down the button for the last digit for a moment.

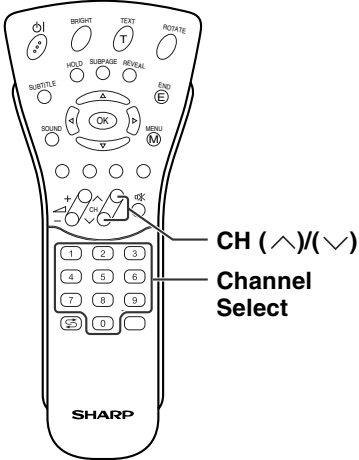

To select a one-digit channel (e.g. Channel 5):

- 1 Hold down the **5** button.

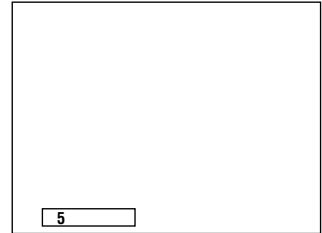

To select a two/three-digit channel (e.g. Channel 15):

- 1 Press the **1** button.
- 2 Hold down the **5** button.

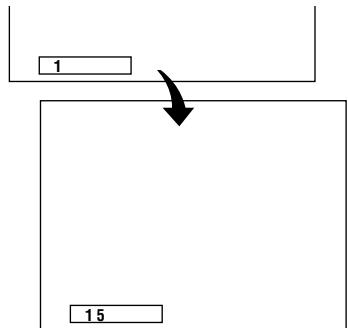

Using CH (^)/(v)

Press **CH (^)** and the channels change in the order shown below:

1 → 2 → 3 → ... → 198 → 199 → 0 → 1 → 2 → 3 → ...

Press **CH (v)** and the channels change in the order shown below:

3 → 2 → 1 → 0 → 199 → 198 → ... → 3 → 2 → 1 → ...

Note:

- Channel "0" is prepared for RF output of VCR.

Selecting Menu Items

- The menus can be used to adjust the various settings of your LCD TV set. Select the desired menu item by following the steps below.

■ Using TV Menus

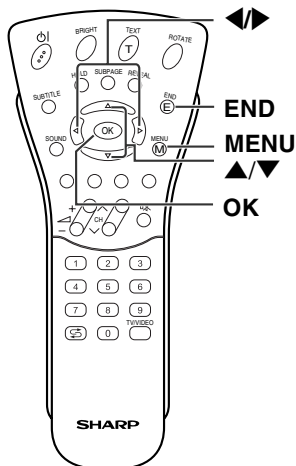

- Press **MENU** on the remote control to display the TV menu.
- Press **▲/▼** to select the desired menu item.
 - The cursor moves up or down.
 - The cursor indicates the selected menu item.
- Press **OK** to display the setting screen for the selected menu item.
 - Press **OK** again to adjust the selected item.
 - See the next page for a table of the setting screens.
- Press **◀▶** to adjust the selected item.
- Press **MENU** to return to the previous screen or **END** to return to the normal screen.



■ Using Direct Control Menu

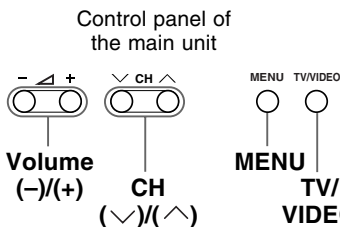

- Press **MENU** on the main unit to display the TV menu.
- Press **CH (v)/(^)** to select the desired menu item.
 - The cursor moves up or down.
 - The cursor indicates the selected menu item.
- Press **TV/VIDEO** to display the setting screen for the selected menu item.
 - Press **TV/VIDEO** again to adjust the selected item.
- Press **Volume (-)/(+)** to make the adjustment.
- Press **MENU** to return to the previous screen.
 - Each time **MENU** is pressed, you will return the previous screens.



Note:

- The items displayed differ depending on the setting conditions.
- The item selected is displayed in yellow.
- The adjustment values and settings which were changed before the screen is restored are saved as is in the memory.

Basic Operation (Continued)

Selecting Menu Items (Continued)

■ TV Menu Setting Screens

For details on using each setting screen, refer to the page number indicated.

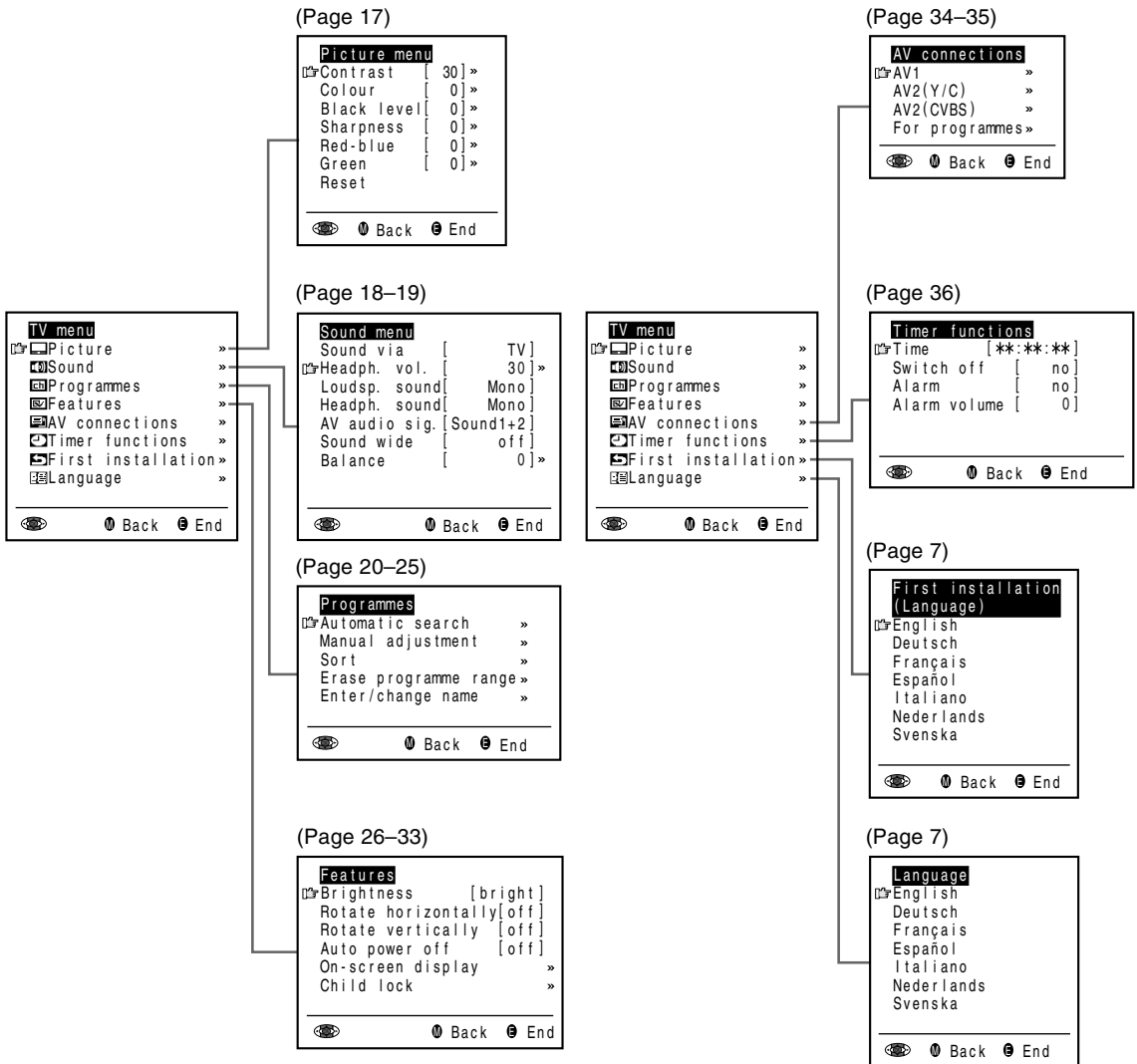

Useful Features

Adjusting Picture Settings

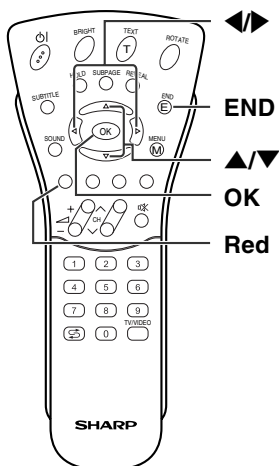

1 Press **Red** to display the Picture menu.

Note:

- The Picture menu can also be displayed by selecting "Picture" in the TV menu (see pages 15 and 16).

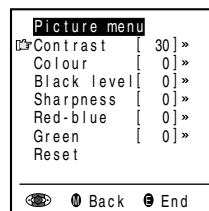

2 Press **▲/▼** to select the desired adjustment item, and then press **OK**.

- The next menu appears.

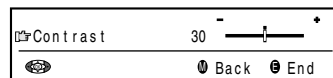

3 Press **◀/▶** to make the adjustment.

4 Press **END** to exit.

Adjustment item	Press Left (◀)	Choice/Value range	Press Right (▶)
Contrast	Decrease contrast	0 – 60	Increase contrast
Colour	Lower colour intensity	-30 – 30	Higher colour intensity
Black level	Less bright	-30 – 30	More bright
Sharpness	Soft picture	-3 – 3	Sharp picture
Red-blue	More red	-5 – 5	More blue
Green	Less green	-5 – 5	More green
Tint *	Towards purple	-30 – 30	Towards green
Reset	Reset value (Press OK .)		

* The menu function is only visible when "N358" or "N443" signal has been input into the unit.

Useful Features (Continued)

Adjusting Sound Settings

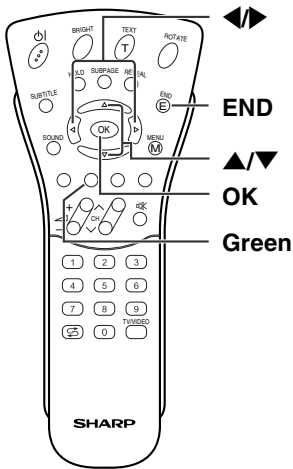

1 Press **Green** to display the Sound menu.

Note:

- The Sound menu can also be displayed by selecting "Sound" in the TV menu (see pages 15 and 16).

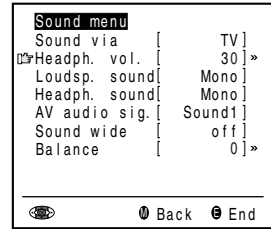

2 Press **▲/▼** to select the desired adjustment item, and then press **OK**.

- Each item can now be selected or the next menu appears.

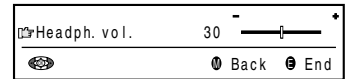

3 Press **◀▶** to make the adjustment.

4 Press **END** to exit.

Adjustment item	Press Left (◀)	Choice/Value range	Press Right (▶)
Sound via	—	TV ↔ Hi-fi	—
Headph. vol.*	Decrease headphones volume	0 – 60	Increase headphones volume
Loudsp. sound	—	Stereo ↔ Mono/Sound1 ↔ Sound2 ↔ Sound1+2 ↔ Mono Nicam ↔ Mono/Mono (* The choices differ depending on whether or not a NICAM or IGR signal is received.) See pages 37 and 38.	—
Headph. sound*			
AV audio sig.	—	Sound1 ↔ Sound2 ↔ Sound1+2	—
Sound wide*	—	off ↔ on	—
Balance*	Increase the volume of the left speaker	-15 – 15	Increase the volume of the right speaker

* These items are not displayed when the "Sound via" item is set to "Hi-fi".

Note:

- In the "AV audio sig." item, mono-video recorders should select "Sound1" or "Sound2". Stereo-video recorders should select "Sound1+2" so that the desired sound can be selected when playing back the video.

Hi-fi Sound Settings

This programme allows you to enjoy higher sound quality when connecting the AUDIO OUT terminals to an external amplifier using an audio cord.

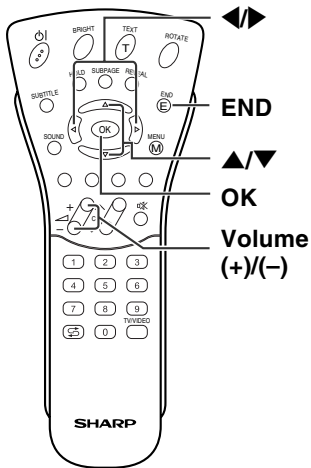

- 1 When switching “Sound via” to “Hi-fi” in the Sound menu on page 18, the sound from the built-in speakers will be turned off.
- 2 Press ▲/▼ to select the desired adjustment item, and then press **OK**.
- 3 Press ◀▶ to select the Sound mode.
- 4 Press **END** to exit.

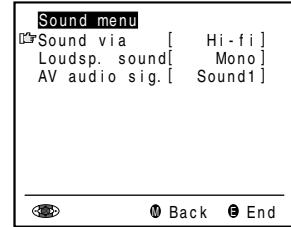

Note:

- Pressing **Volume (+)/(-)** will display the volume indicator shown on the right. You can adjust the volume by pressing + or – on the same button.



* To exit this mode, in the Sound menu, switch “Sound via” from “Hi-fi” to “TV”.

Using Programme Table

The Programme table shows a list of all receivable programmes. They are located in channels 0 to 199. The currently selected programme is displayed in yellow, and the child-locked programmes are displayed in red.

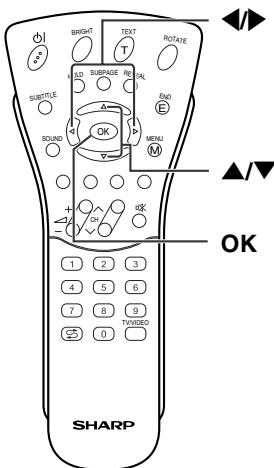

To select the desired programme

- 1 Press **OK** to display the Programme table.
- 2 Press ▲/▼ and/or ◀▶ to select the desired programme.
 - To display the next or previous list of the Programme table, press ▲/▼ when the cursor is at a programme in the lower-right or upper-left position, or press ◀▶ when the cursor is at a programme in the right or left column.
- 3 Press **OK** to display the selected programme.

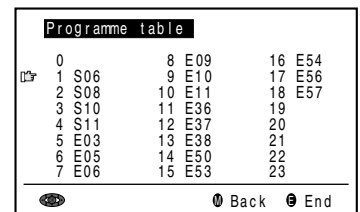

Useful Features (Continued)

Programmes

[1] Automatic search

Perform the procedure below to search for and store new programmes after the First Installation routine.

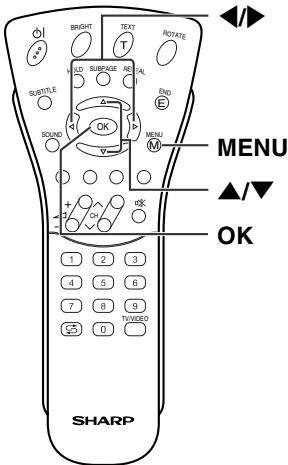

- 1 Press **MENU** to display the TV menu.
- 2 Press **▲/▼** to select “Programmes”, and then press **OK** to display the “Programmes” screen.
- 3 Press **▲/▼** to select “Automatic search”, and then press **OK** to display the “Automatic search” screen.

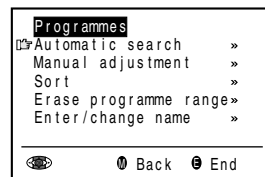

- 4 Press **▲/▼** to select the desired item, and then press **OK**. Press **◀/▶** to select the desired item.

Note:

- You can change “Colour system” and “Sound system” only when “Other Countries” is selected in “Country”.

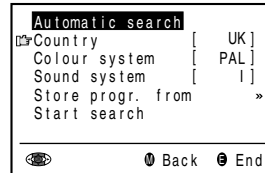

- 5 Press **▲/▼** to select “Store progr. from”, and then press **OK** to display the “Store progr. from” screen.

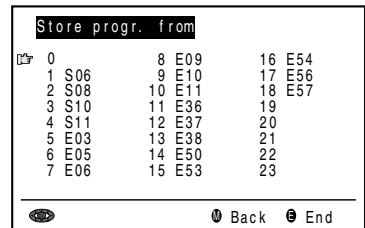

Programmes (Continued)

[1] Automatic search (Continued)

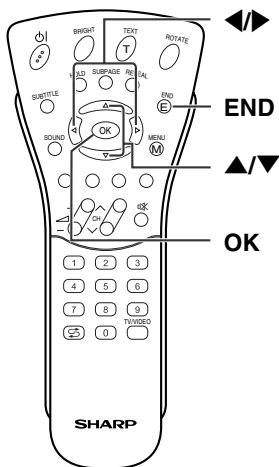

6 Press ▲/▼ and/or ◀/▶ to select the programme position from which the programmes are to be stored, and then press **OK**.

Store progr. from			
0		8 E09	16 E54
1	S06	9 E10	17 E56
2	S08	10 E11	18 E57
3	S10	11 E36	19
4	S11	12 E37	20
5	E03	13 E38	21
6	E05	14 E50	22
7	E06	15 E53	23

◀ Back ▶ End

7 Press ▲/▼ to select “Start search”, and then press **OK** to begin the automatic programme search.

Note:

- See pages 7 and 8 for details of the search process.

Automatic search	
Country	[UK]
Colour system	[PAL]
Sound system	[I]
Store progr. from	»
▶ Start search	

◀ Back ▶ End

8 After the search is completed, press **END** to exit.

Useful Features (Continued)

Programmes (Continued)

[2] Manual adjustment

Individual settings of programmes can be adjusted.

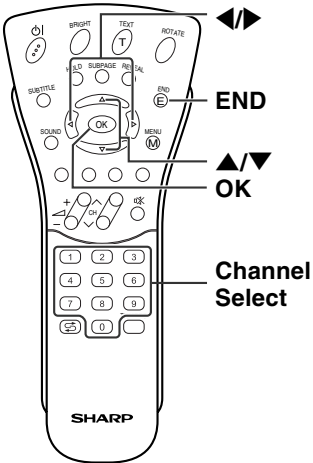

- 1 Perform steps 1 and 2 in [1] **Automatic search** to display the "Programmes" screen.
- 2 Press ▲/▼ to select "Manual adjustment", and then press **OK** to display the "Manual adjustment" screen.

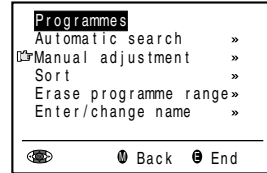

- 3 Press ▲/▼ to select the item, and then press ◀▶ to make the adjustment. (See the table below for details.)
 - You can also use **Channel Select** to adjust the "Frequency" items.
 - To adjust "Name", first press **OK** to active the text input mode. Press ◀▶ to select the input position and press ▲/▼ to select the desired character. When you finish inputting, press **OK** to set the name.

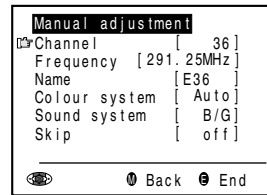

- 4 Press **END** to exit.

Adjustment item	Choice/Value range	Description
Channel	0-199	The channel changes to the higher or lower channel.
Frequency	044 – 859 (MHz)	Receivable frequencies depending on TV norm, installation site, and range.
Name	A – Z, +, -, ., !, /, 0 – 9	Programme name (up to five characters).
Colour system	Auto, PAL, SECAM	Colour norm.
Sound system	B/G, I, D/K, L	TV norm.
Skip	on ↔ off	Channel numbers with a "(●) (RED)" mark on the left are set to SKIP.

Note:

- Depending on the settings in the colour system of the channels, switching between channels may be slow. If you want to speed up channel switching, switch "Auto" in "Colour system" to the current reception system (PAL or SECAM).

Programmes (Continued)

[3] Sort

The programme positions for individual programmes can be freely changed.

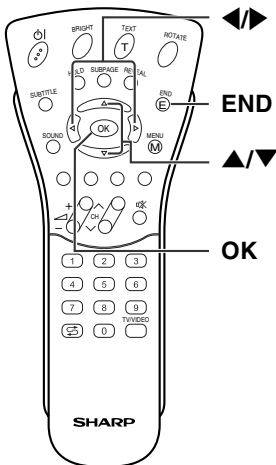

1 Perform steps 1 and 2 in [1] **Automatic search** to display the “Programmes” screen.

2 Press ▲/▼ to select “Sort,” and then press **OK** to display the “Sort” screen.

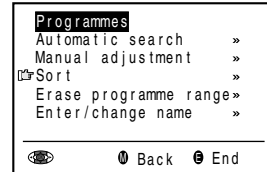

3 Press ▲/▼ and/or ◀/▶ to select the desired programme, and then press **OK** to sort.

- When **OK** is pressed, the Move mode is activated. Press ▲/▼ to move the currently marked programme to the desired programme position. The marked programme is swapped with the programme at the selected programme position. Press **OK** to leave the Move mode.

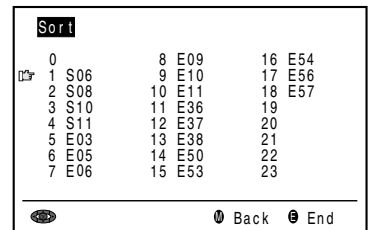

4 Press **END** to exit.

Useful Features (Continued)

Programmes (Continued)

[4] Erase programme range

The individual programme or programmes in a connected range can be erased.

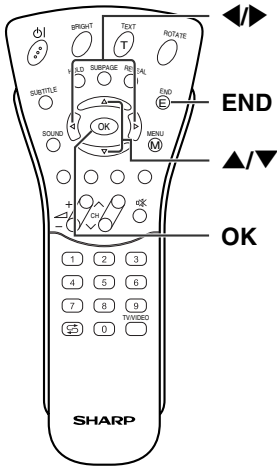

1 Perform steps 1 and 2 in [1] **Automatic search** to display the “Programmes” screen.

2 Press **▲/▼** to select “Erase programme range”, and then press **OK** to display the “Erase programme range” screen.

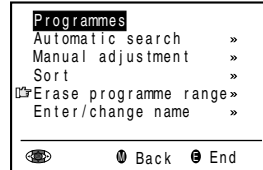

3 Press **▲/▼** and/or **◀▶** to select the programme to be erased, and then press **OK**. The selected programme is shown in yellow.

- If you want to erase programmes in a connected range, select the programme at the beginning of the desired range.

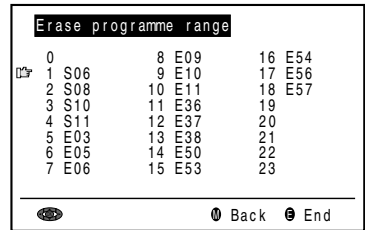

4 If you are erasing programmes in a connected range, press **▲/▼** and/or **◀▶** to select the programme at the end of the range. The selected programmes are shown in yellow.

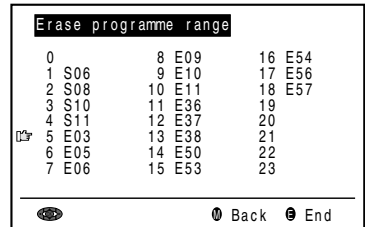

5 Press **OK** to erase the selected programme(s). All the subsequent programmes move up.

6 Press **END** to exit.

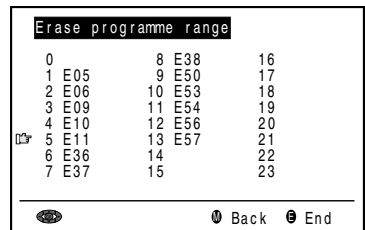

Programmes (Continued)

[5] Enter/change name

The name of an individual programme can be entered or changed.

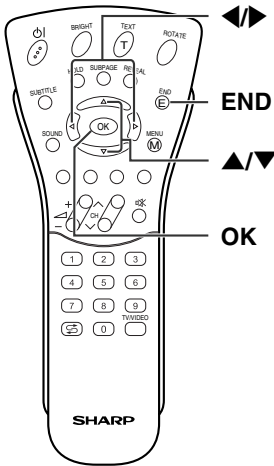

1 Perform steps 1 and 2 in [1] **Automatic search** to display the “Programmes” screen.

2 Press ▲/▼ to select “Enter/change name”, and then press **OK** to display the “Enter/change name” screen.

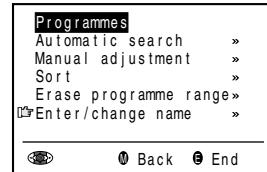

3 Press ▲/▼ and/or ◀▶ to select the desired programme, and then press **OK**. The character at the input position blinks.

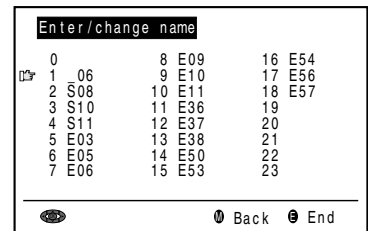

4 Press ◀▶ to select the input position, and then press ▲/▼ to select the desired character.

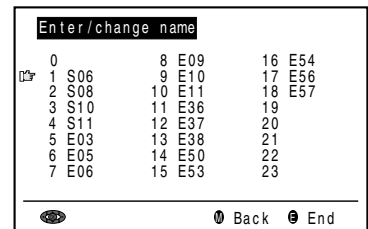

5 Press **OK** to accept the name entered, and then press **END** to exit.

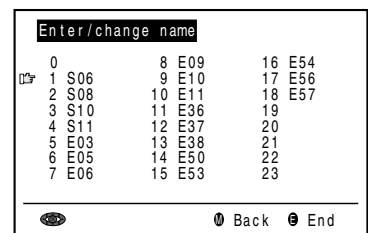

Useful Features (Continued)

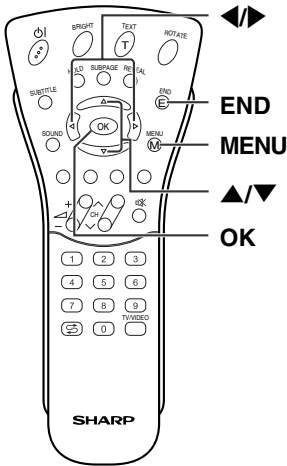

Features

The Feature items can be set by the user.

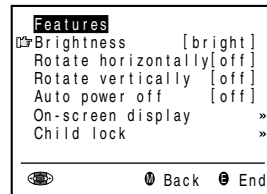

- 1 Press **MENU** to display the TV menu.
- 2 Press **▲▼** to select “Features”, and then press **OK** to display the “Features” screen.
- 3 Press **▲▼** to select the desired adjustment item, and then press **OK**.
- 4 Press **◀▶** to make the adjustment. (Except “On-screen display” and “Child lock” menu items)
- 5 Press **END** to exit.

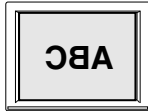

Selected item	Factory setting	Setting change
Brightness*	[bright] Maximum brightness	[medium] Brightness 60% → Suitable for viewing in well-lit areas. Saves energy. [dark] Brightness 20% → Sufficiently bright when viewing in dim areas.
Rotate horizontally*	[off] Normal horizontal image orientation	[on] Mirror image → To display mirror images for special uses. 
Rotate vertically*	[off] Normal vertical image orientation	[on] Inverted image → To display images upside down for special uses. 
Auto power off (only TV mode)	[off] This feature is inactive.	[on] The power of the LCD TV set is turned off when there is no signal for 5 minutes.

* Brightness and Rotate can be switched in one touch using the remote control (See page 27).

Features (Continued)

You can change the setting screen of BRIGHTNESS and ROTATE directly.

[1] Directly Setting the BRIGHTNESS

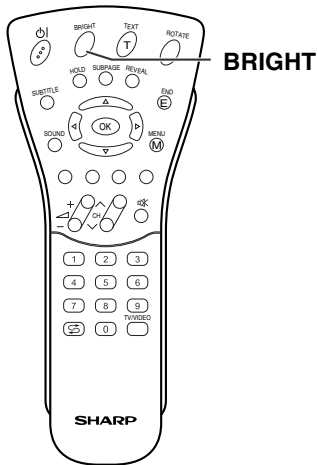

- 1 Press **BRIGHT** to display the Brightness screen.
- 2 Each time you press **BRIGHT**, the mode changes as follows. You can select the desired mode.
bright → **medium** → **dark**

Note:

- The Brightness screen automatically disappears after 4 seconds.
- The Brightness is set to "bright" at the factory setting.
- See the table of page 26 for details of the each brightness setting.

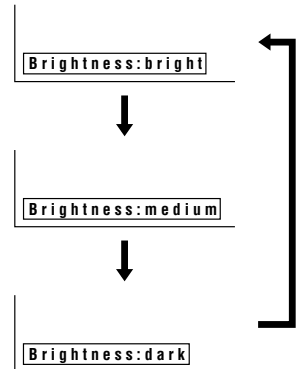

[2] Directly Setting the ROTATE

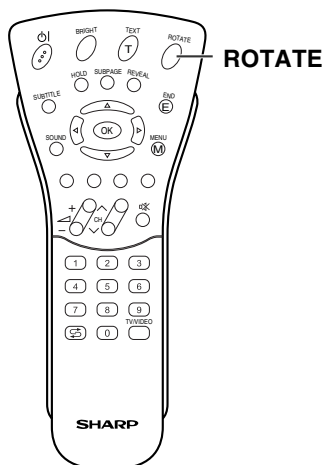

- 1 Press **ROTATE** to display the Rotate screen.
- 2 Each time you press **ROTATE**, the mode changes as follows. You can select the desired mode.

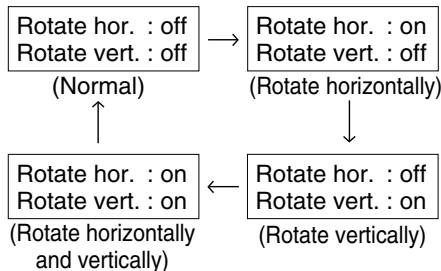

Note:

- The Rotate screen automatically disappears after 4 seconds.
- The Rotate is set to "Normal" at the factory setting.
- When changing settings directly made, settings in the menu can also be changed.
- See the table of page 26 for details of the each rotate setting.

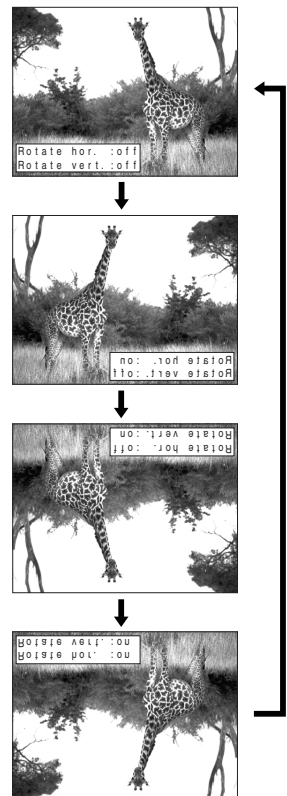

Useful Features (Continued)

On-screen Display

You can adjust various settings for on-screen displays.

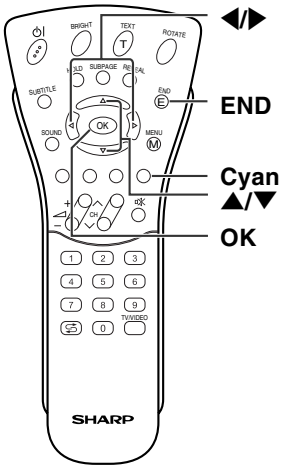

- 1 Perform steps 1 and 2 in **Features** to display the “Features” screen.
- 2 Press ▲/▼ to select “On-screen display” and then press **OK** to display the “On-screen display” screen.
- 3 Press ▲/▼ to select the desired adjustment item. (See the table below.)
- 4 Press ◀/▶ to make the adjustment.
- 5 Press **END** to exit.

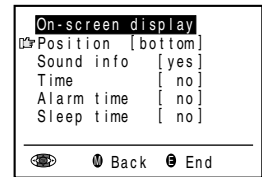
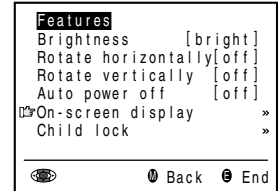

Adjustment item	Choice/Value range	Description
Position	bottom ↔ top	To select the position of the On-screen display.
Sound info	no ↔ yes	To select information to be displayed in the On-screen display. To activate the On-screen display, use the Cyan button.
Time	no ↔ yes	
Alarm time	no ↔ yes	
Sleep time	no ↔ yes	

Child Lock

Important:

- Please refer to page 53 for “IMPORTANT NOTE ON DISENGAGING ADVANCED CHILD LOCK”.

The Child Lock function blocks the viewing of any channel for which the child lock has been set. To use the Child Lock function, you first need to define your PIN (Personal Identification Number).

[1] Defining a PIN

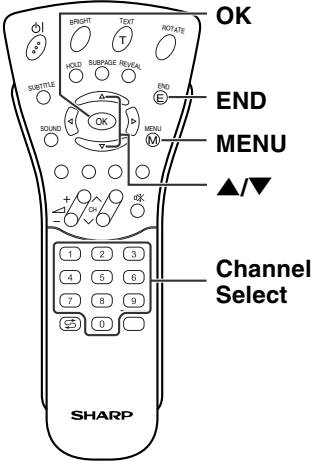

1 Perform steps 1 and 2 in **Features** to display the “Features” screen.

2 Press **▲/▼** to select “Child lock”.

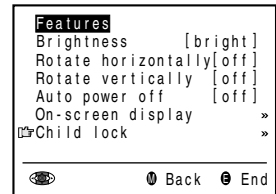

3 Press **OK** to display the PIN input screen.

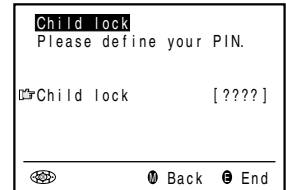

4 Input the desired four-digit PIN (e.g. 1234) with **Channel Select**.

Note:

- Be sure to make a note of your PIN before pressing **OK**.
- The PIN will not be set if **MENU** or **END** is pressed before the fourth digit has been input.

5 Press **OK** to accept the entered PIN.

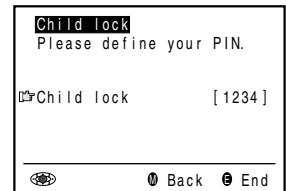

Useful Features (Continued)

Child Lock (Continued)

[2] Changing/Cancelling a PIN

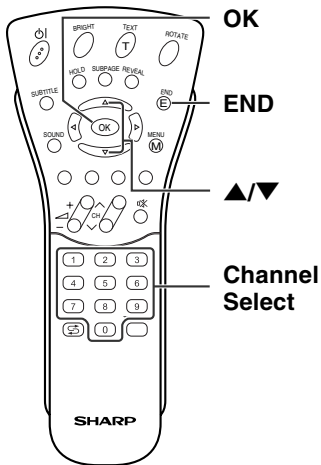

To change a PIN

- 1 Perform steps 1 to 3 in [1] **Defining a PIN** to display the PIN input screen.
- 2 Enter your four-digit PIN (e.g. 1234) with **Channel Select**.

Note:

- Numbers entered are hidden with ????.
- If the PIN has been input incorrectly, "Wrong PIN!" is displayed.

When the PIN is correctly entered, the "Child lock" screen appears.

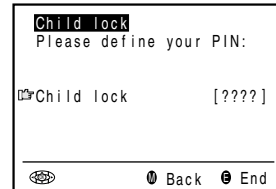

- 3 Press ▲/▼ to select "Change PIN", and then press **OK**. The currently defined PIN is displayed.

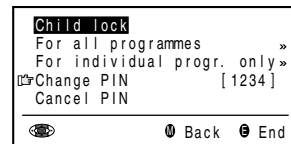

- 4 Input the new four-digit PIN (e.g. 5678) with **Channel Select**.
- 5 Press **END** to exit.

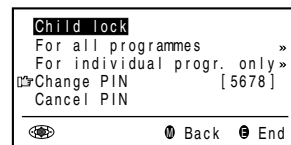

To cancel a PIN

- In step 3 above, press ▲/▼ to select "Cancel PIN", and then press **OK** to cancel the currently defined PIN.

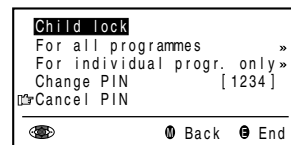

Child Lock (Continued)

[3] Setting a Child Lock

There are four different ways of activating a child lock:

1. General child lock for all programmes immediately
2. General child lock for all programmes with daily time limit
3. General child lock for all programmes with single time limit
4. Programme-position related child lock without time limit

The Child Lock comes into effect only after the LCD TV set has entered the standby mode and is then turned on again.

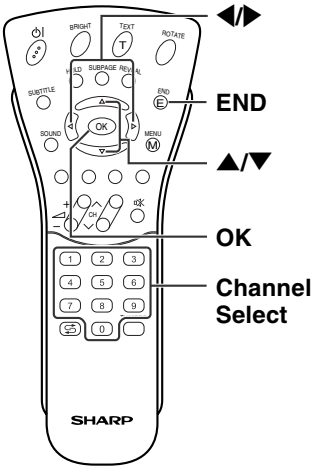

To set a Child Lock for all programmes with a time limit

- 1 Perform steps 1 to 3 in [2] Changing/Cancelling a PIN to display the “Child lock” screen.
- 2 Press ▲/▼ to select “For all programmes”, and then press OK to display the “For all programmes” screen.
- 3 Press ▲/▼ to select the desired item. (See the table below.)
- 4 Press ◀/▶ to select the desired choice, and, if required, input digits with **Channel Select**.
- 5 Press **END** to exit.

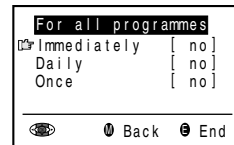
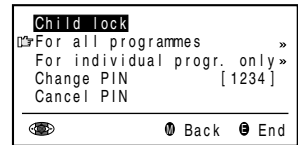

Note:

- If the current clock time is within the time limit, the Child Lock is activated immediately after the LCD TV set is turned off and on again. For example, if the current clock time is 9:00 and the time limit is specified from 22:00 to 14:00, the lock is effective from 9:00 to 14:00.
- When a Child Lock is set for all programmes with a time limit, the “Time” item is not displayed in the TV menu and cannot be selected.

Adjustment item	Choice/Input value	Description
Immediately	no ↔ yes	Select “yes” to activate the Child Lock immediately (after the LCD TV set has been turned off and on again). The lock remains effective until “no” is selected.
Daily	no ↔ HH:MM-HH:MM	Input the start and end time for a daily-recurring Child Lock. The lock is activated everyday unless “no” is selected.
Once	no ↔ HH:MM-HH:MM	Input the start and end time for a once-only Child Lock. The length of the period should be up to 24 hours.

Warning:

- The timer takes its clock information from the Teletext broadcast. The teletext broadcast may be in a different time zone and therefore child lock timer may not activate as expected. Concerning this detail, please refer to page 39.

Useful Features (Continued)

Child Lock (Continued)

[3] Setting Child Lock (Continued)

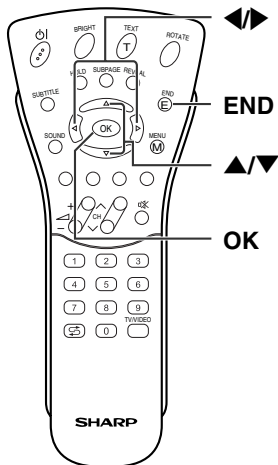

To set a Child Lock for individual programmes without time limit

1 Perform steps 1 to 3 in [2] Changing/Canceling a PIN to display the “Child lock” screen.

2 Press ▲/▼ to select “For individual progr. only”, and then press **OK** to display the “For individual progr. only” screen.

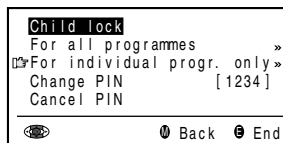

3 Press ▲/▼ and/or ◀/▶ to select the desired programme.

4 Press **OK** to lock the programme. The locked programme is displayed in red.

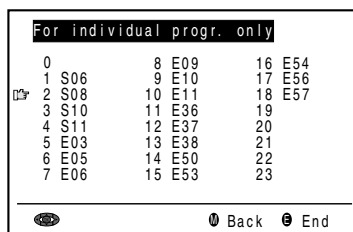

Note:

- To unlock the programme, select the programme and press **OK**.
- The Child Lock remains effective until it is cancelled.

5 Press **END** to exit.

Note:

- When a Child Lock is activated, the “Programmes” and “First installation” items are not displayed in the TV menu and cannot be selected.

Child Lock (Continued)

[4] Temporarily cancelling the Child Lock setting

You can view a programme for which a Child Lock has been set by temporarily cancelling the Child Lock setting. Perform the procedure below to input your PIN and cancel the Child Lock if you are prompted to do so.

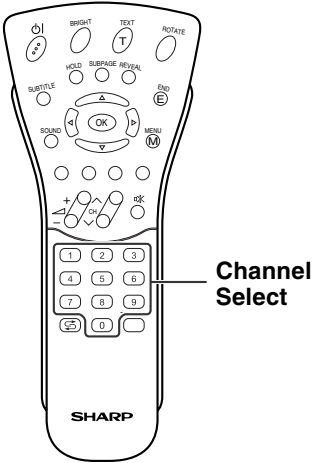

- When the PIN input screen appears, input your PIN with **Channel Select**. The normal screen appears when the PIN is correctly entered.

Note:

- If the PIN has been input incorrectly, "Wrong PIN!" is displayed.

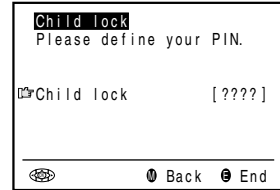

Useful Features (Continued)

AV Connections

It is possible to manually adjust various settings for connections with external devices on the “AV connections” screen.

[1] AV1/AV2

Select the appropriate signal type and colour standard for the signals from the video equipment connected to the AV1 or AV2 terminal.

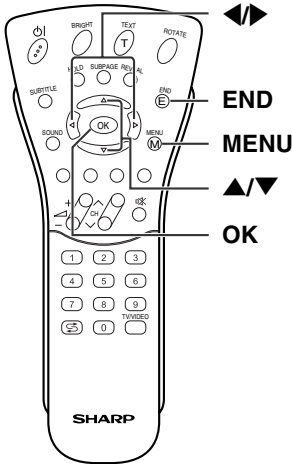

- 1** Press **MENU** to display the TV menu.
- 2** Press **▲/▼** to select “AV connections”, and then press **OK** to display the “AV connections” screen.
- 3** Press **▲/▼** to select “AV1”, “AV2 (Y/C)”, and “AV2(CVBS)”, and then press **OK** to display the signal type selection screen.
- 4** Press **▲/▼** to select the desired item, and then press **OK**.
- 5** Press **◀/▶** to select the desired “Signal type”, “AFC” and “Colour system”, and then press **OK**.
- 6** Press **END** to exit.

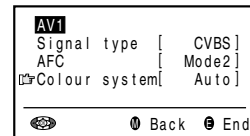
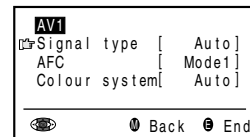
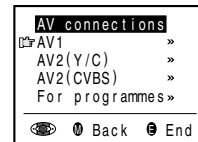

Adjustment item	Choice/Input value	Description
Signal type*	Auto, CVBS, Y/C	To select the signal type of external equipment.
AFC	Mode1, Mode2	To select frequency control modes. Mode1 is suitable for DVD players or decoders, and Mode2 is suitable for VCRs or Camcorders.
Colour system	Auto, PAL, SECAM, N358 (NTSC 3.58), N443 (NTSC 4.43), PAL60, PAL-M, PAL-N	Colour norm.

* The menu function is only visible when the AV1 is selected.

Note:

- If no (colour) image displays, try to change the other signal type.
- Depending on the compatibility with the various types of equipment, the picture may become skewed. In this case, select the “AFC” (Automatic Frequency Control) mode that will improve the picture.
- Switching between AV input signals may be slow, depending on the settings in “Colour system”. If you want to speed up signal switching, switch “Auto” in “Colour System” to the current reception colour system.

AV Connections (Continued)

[2] For programmes

- The influence of the AV control voltage and of fast blank at programme positions from 1 to 199 can be set.
- When connecting a video device to the AV1 terminal, you need to adjust the decoder programme settings.

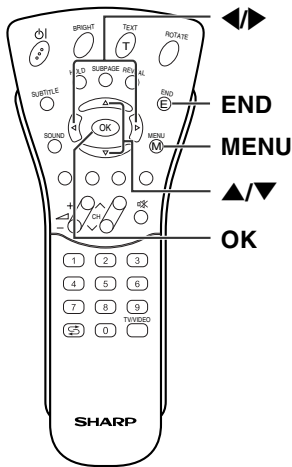

- 1 Perform steps 1 and 2 in [1] AV1/AV2 to display the “AV connections” screen.
- 2 Press ▲/▼ to select “For programmes”, and then press **OK** to display the “For programmes” screen.

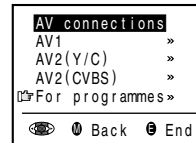

- 3 Press ▲/▼ to select the “AV control voltage” or “RGB on-screen display”.
- 4 Press ◀▶ to select “yes” or “no”.

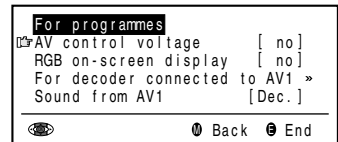

Note: ▶

- If the item concerned is set to “yes”, the appropriate picture is through-connected at all programme positions from 1 to 199 when a control voltage/an RGB signal is applied.

- 5 Press ▲/▼ to select “For decoder connected to AV1”, and then press **OK** to display the decoder programme selection screen.

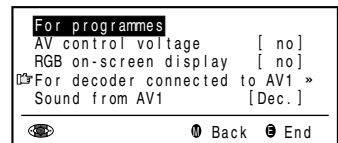

- 6 Press ▲/▼ and/or ◀▶ to select the programme for the decoder, and then press **OK**. Repeat the same procedure if you want to specify other decoder programmes.

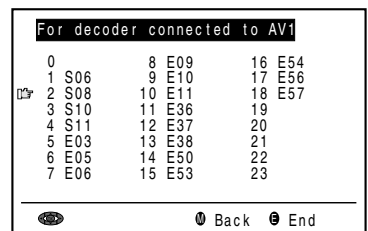

- 7 Press **MENU** to return to the “For programmes” screen.

- 8 Press ▲/▼ to select “Sound from AV1”, and then press ◀▶ to select the desired sound source.

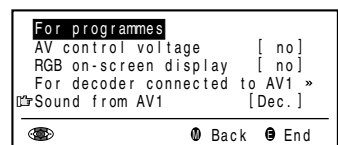

- 9 Press **END** to exit.

Useful Features (Continued)

Timer Functions

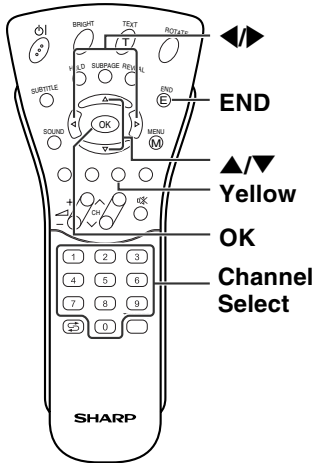

1 Press **Yellow** to display the “Timer functions” screen.

Note:

- The “Timer functions” screen can also be displayed by selecting “Timer functions” in the TV menu. (see pages 15 and 16.)

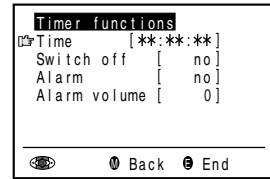

2 Press **▲/▼** to select “Time”, and then press **OK**.

3 Input the current time (HH:MM:SS) with **Channel Select**.

4 Press **▲/▼** to select the desired item. (See the table below.)

5 Press **◀▶** to make the adjustment. If you select “00:00” for “Switch off” or “Alarm”, input the desired time with **Channel Select**.

6 Press **END** to exit.

Adjustment item	Choice/Input value/Value range	Description
Time	HH:MM:SS	The time can be manually set.
Switch off	no ↔ HH:MM	The LCD TV set automatically turns off at the specified time everyday.
Alarm	no ↔ HH:MM	The alarm sound turns on at the specified time everyday.
Alarm volume	0 – 39	The volume of the alarm sound is selected.

NICAM Broadcast Selection

This enables the selection of the reception mode when receiving a NICAM-I or NICAM-B/G signal. To let you enjoy NICAM broadcasting, this LCD TV set receives NICAM system stereo, bilingual, and monaural broadcasts.

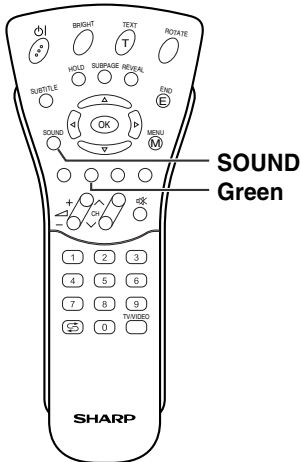

Stereo

The LCD TV set is receiving a stereo broadcast.

- Each time you press **SOUND**, the mode changes between “Stereo” and “Mono”.
- When “Mono” is selected, the TV sound is output monaurally.

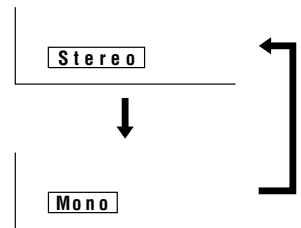

Bilingual

When the LCD TV set is receiving a bilingual programme, the “Sound 1” mode is automatically selected.

- Each time you press **SOUND**, the mode changes as follows:
Sound 1 → **Sound 2** → **Sound 1+2**
 → **Mono**

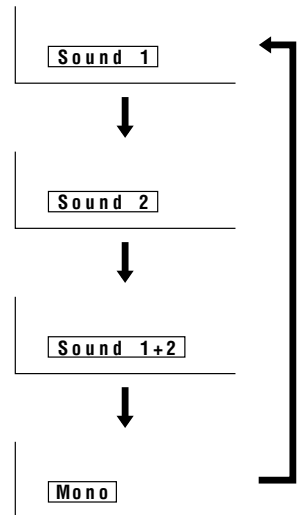

Monaural

The LCD TV set is receiving a monaural broadcast.

- Each time you press **SOUND**, the mode changes between “Nica m” and “Mono”.

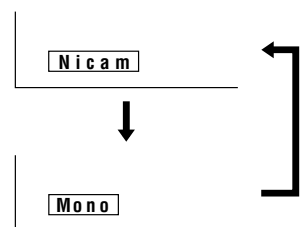

Note:

- If approximately 3 seconds pass without a button being pressed, the mode setting is automatically terminated and the LCD TV set returns to the normal mode.
- The setting can be individually selected for each channel number.
- You can also turn off the NICAM mode by setting the “Loudsp. sound” item to “Mono” in the Sound screen, which is displayed when you press **Green** (see page 18).

Useful Features (Continued)

IGR (German stereo system) Broadcasts

This enables the selection of the reception mode when receiving an IGR-B/G signal. To let you enjoy IGR broadcasting, this LCD TV set receives IGR system stereo and bilingual broadcasts.

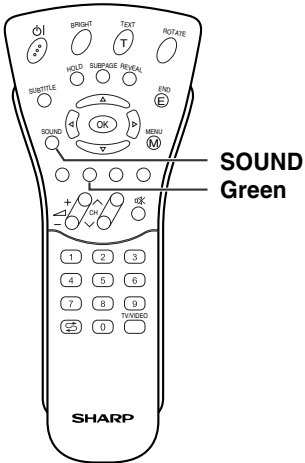

Stereo

The LCD TV set is receiving a stereo broadcast.

- Each time you press **SOUND**, the mode changes between “Stereo” and “Mono”.
- When “Mono” is selected, the TV sound is output monaurally.

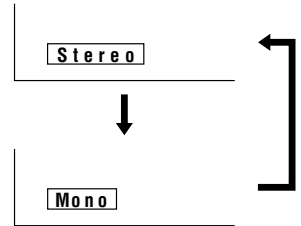

Bilingual

When the LCD TV set is receiving a bilingual programme, the “Sound 1” mode is automatically selected.

- Each time you press **SOUND**, the mode changes as follows:
Sound 1 → **Sound 2** → **Sound 1+2**
→ **Mono**

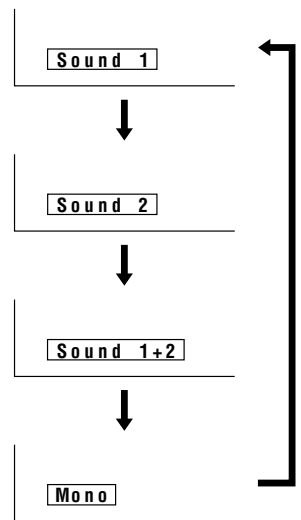

Note:

- If approximately 3 seconds pass without a button being pressed, the mode setting is automatically terminated and the LCD TV set returns to normal mode setting.
- The setting can be selected individually for each channel number.
- You can also turn off the IGR mode by setting the “Loudsp. sound” item to “Mono” in the Sound screen, which is displayed when you press **Green** (see page 18).

Teletext

■ What is Teletext?

Teletext is an information service organised like a magazine, which is provided by some TV stations in addition to regular television broadcasting. Your LCD TV set receives special Teletext signals broadcast by a TV station, processes the information and displays it graphically on the screen. News, weather and sports information, stock exchange prices, programme reviews and closed captioning for the deaf are among the many services available through Teletext.

■ Teletext mode

Teletext is activated with **TEXT** on the remote control and is also closed with it. The LCD TV set can be controlled in Teletext mode directly by inputting commands with the remote control and indirectly through the on-screen display (menu system).

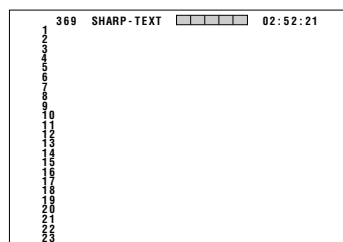

■ Operating instructions in Teletext mode

Only lines 0 - 23 (one transmitted Teletext page) can be displayed on the screen simultaneously. When you turn on a control line holding the operating instructions for TOP text or subpages, the screen is scrolled up one line.

- If FLOF Teletext is broadcast, a control line is transmitted as the 24th line, which cannot be displayed on the screen, so the screen is scrolled up one line and the control line is displayed. To prevent constant loss of information on line 0, the control line is turned off.
- The FLOF system for teletext is transmitted in UK currently.
- The TOP system for teletext is transmitted in Germany currently.
- If TOP Teletext is broadcast, a control line and TOP line can be displayed on the screen. The TOP line involves the operating instructions associated with all of the coloured buttons if TOP text is transmitted, or the operating instructions for only **Red** and **Green** if TOP text is not being transmitted.
- If there are subpages, a control line holding the operating instructions for subpages can be displayed on line 24.

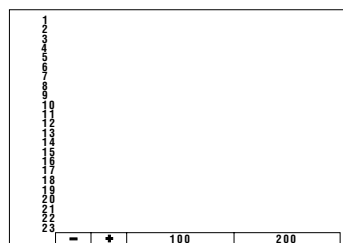

Note:

- When watching the entire Teletext screen, the total lines displayed on the screen is 24 including the first line at the top (the header). The line at the bottom of the screen (the control line) is not displayed. Pressing the colour button will move the page upwards. This will hide the header and display the control line. Pressing again the colour button will return the page back to its original position in a few seconds.
- The header is not displayed while the subpage is displayed. (See page 41)

Teletext (Continued)

[1] Turning on and off Teletext mode

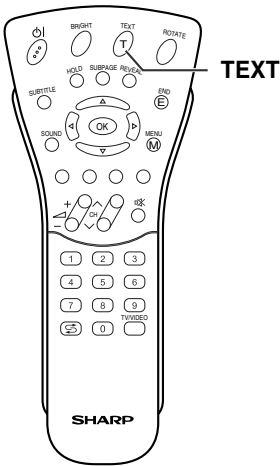

- 1 Select a TV channel that is broadcasting the Teletext programme.
 - 2 Press **TEXT**. The Teletext screen appears.
- To turn off the Teletext mode, press **TEXT** again.

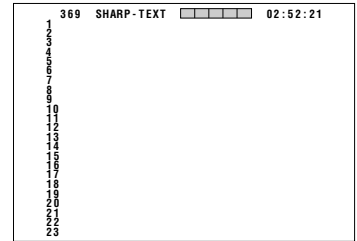

[2] Using the TOP line

When TOP Teletext is being broadcast, you can display the TOP line, which contains the operating instructions on the screen.

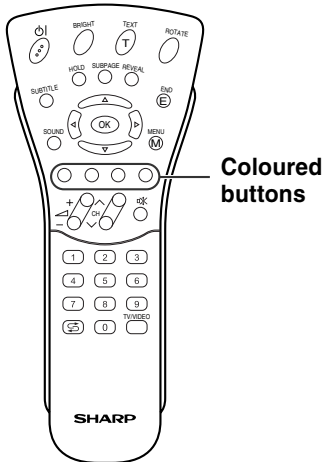

- 1 Press any **Coloured button** to display the TOP line.
- 2 Use the **Coloured buttons** to operate the Teletext screen.
 - Press **Red** to display the previous page and **Green** to display the next page. **Yellow** and **Cyan** are as indicated on the TOP line.

Note:

- By using the **Red** button the previously selected page will appear down to the first page which showed up directly after switching on the video text. Therefore the **Red** button has no function directly after switching on the video text.

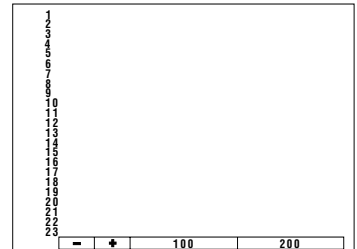

[3] Changing subpages

If a page has been selected from among several subpages, you can display a control line which contains the subpage numbers.

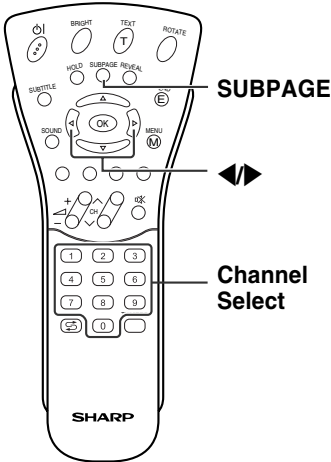

- 1 Press **SUBPAGE**. The screen is scrolled up one line and the control line with the subpage numbers is displayed, and the number of the currently selected subpage is displayed in blue.
- 2 Press **◀▶** to select the desired subpage number. The selected subpage is displayed.
 - You can also use **Channel Select** to select the desired subpage.
- 3 Press **SUBPAGE** to turn off the control line.

Note:

- The header is not displayed while the subpage is displayed.

[4] Using the TOP table

When TOP Teletext is being broadcast, you can display the TOP table with the current programme data if one exists.

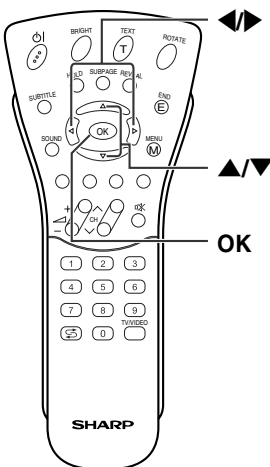

- 1 Press **OK** to display the TOP table. The Teletext page is temporarily turned off.
- 2 Press **▲/▼** to select the desired item. Press **◀▶** to select topics (column 1) or subtopics (column 2) if they exist.
- 3 Press **OK**. A page associated with the selected item is displayed.

Teletext (Continued)

[5] Using Teletext menu

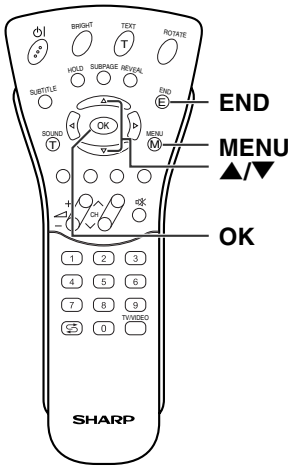

To select the character set

- 1 Press **MENU** to display the "Character set" screen.
- 2 Press **▲/▼** to select the desired character set.
 - The colour of the letters will turn to yellow. When selecting the character set, pressing **OK** will change the letters to magenta for an instant and then return them back to yellow.
- 3 Press **END** to exit.



[6] Useful Features for Teletext

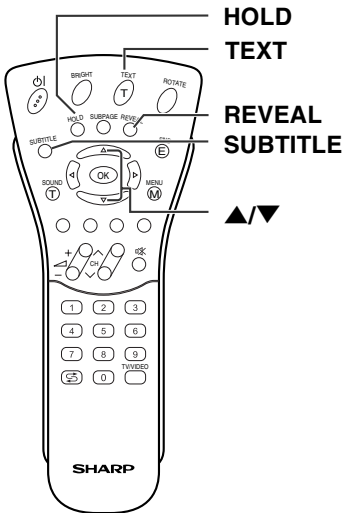

- The **HOLD** button on the remote control can be used to hold the current teletext page. Press the button again to cancel the hold mode.
- **▲/▼** can be used to zoom the current teletext page as below.

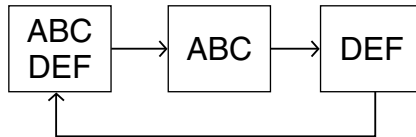

- * The screen displays each mode each time **▲/▼** is pressed.
- The **SUBTITLE** button can be used to quickly activate subtitles.
- * Press **TEXT** to deactivate subtitles.
- The **REVEAL** button can be used to display hidden information such as solutions to riddles and puzzles. Press the button again to hide the information.

Connecting External Devices

It is possible to enjoy video and sound by connecting a VCR and home video game system to the terminals located on the rear of the main unit.

When connecting an external device, turn off the power of the main unit and connecting device to prevent any possible damage.

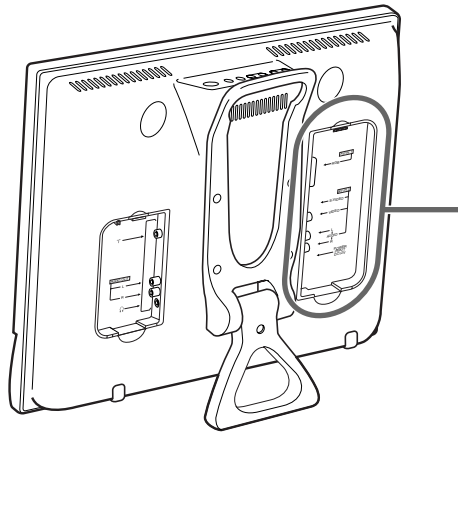

To AV-IN 1 or 2 terminal

Examples of external devices that can be connected

- Video camera
- Home video game system
- VCR
- Laser disc player
- DVD
- Decoder

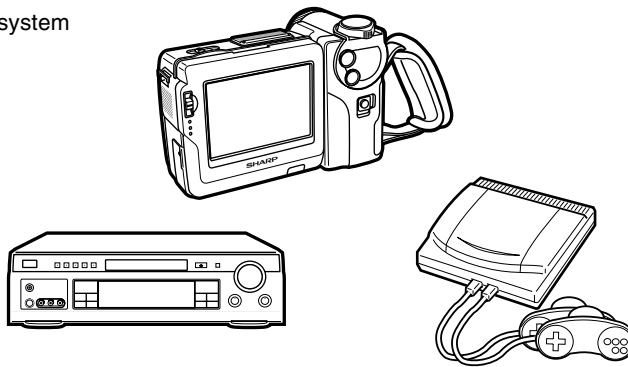

* PC connection is not possible.

Note:

- Use a commercially available audio/video cord for the cable.
- Only connect audio/video signals to AV-IN 1 and 2 terminals. Connecting other signals may result in a malfunction.
- The VIDEO input terminal and the S-VIDEO input terminal on the AV-IN 2 side are shared connections with priority given to the S-VIDEO terminal. If both terminals are connected, the video signals from the S-VIDEO input terminal are selected for the AV-IN 2 input.
When viewing video from the VIDEO input terminal, do not connect anything to the S-VIDEO input terminal.
- For details concerning usage and connection of external devices, see the respective instruction manuals.

Connecting External Devices (Continued)

Connecting a Decoder through the 21-pin Euro-SCART (AV-IN 1/RGB)

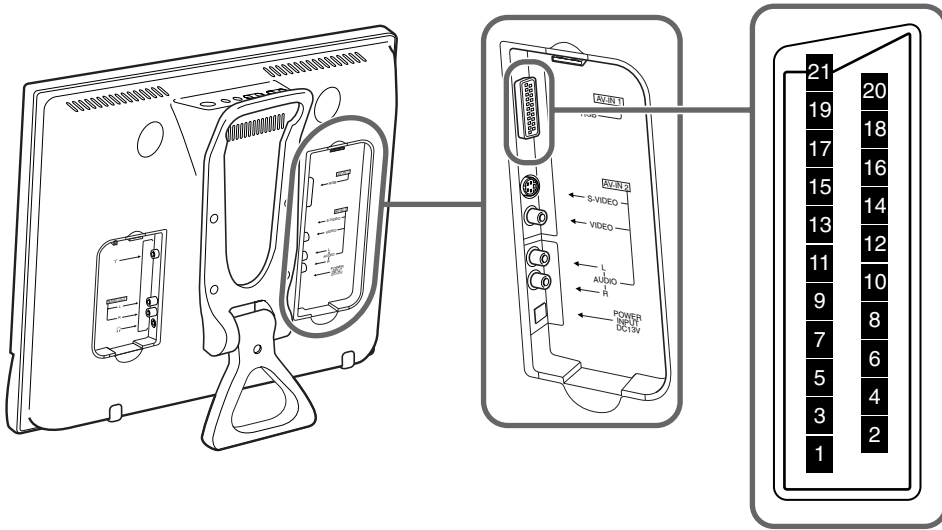

21-pin Euro-SCART (RGB)

- | | | |
|---------------------------|------------------------|--------------------------------------|
| 1. Audio right output | 8. Audio-video control | 15. RED input |
| 2. Audio right input | 9. Earth for green | 16. RED/GREEN/BLUE control |
| 3. Audio left output | 10. Not used | 17. Earth for video |
| 4. Common earth for audio | 11. GREEN input | 18. Earth for RED/GREEN/BLUE control |
| 5. Earth for blue | 12. Not used | 19. Video output |
| 6. Audio left input | 13. Earth for red | 20. Video input (PAL/SECAM/NTSC) |
| 7. BLUE input | 14. Not used | 21. Plug shield |

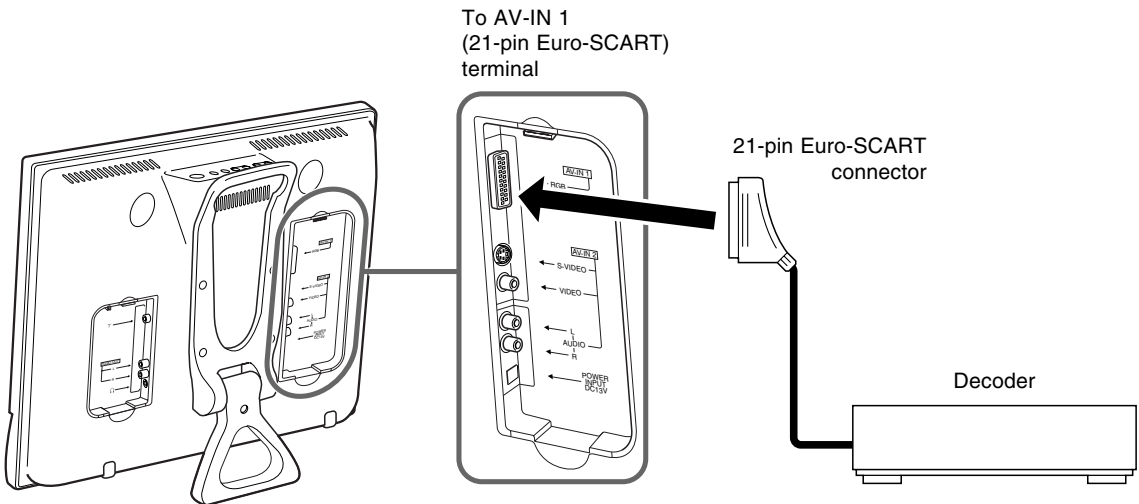

Connecting External Devices (Continued)

Connecting a VCR or a home video game system (AV-IN 2)

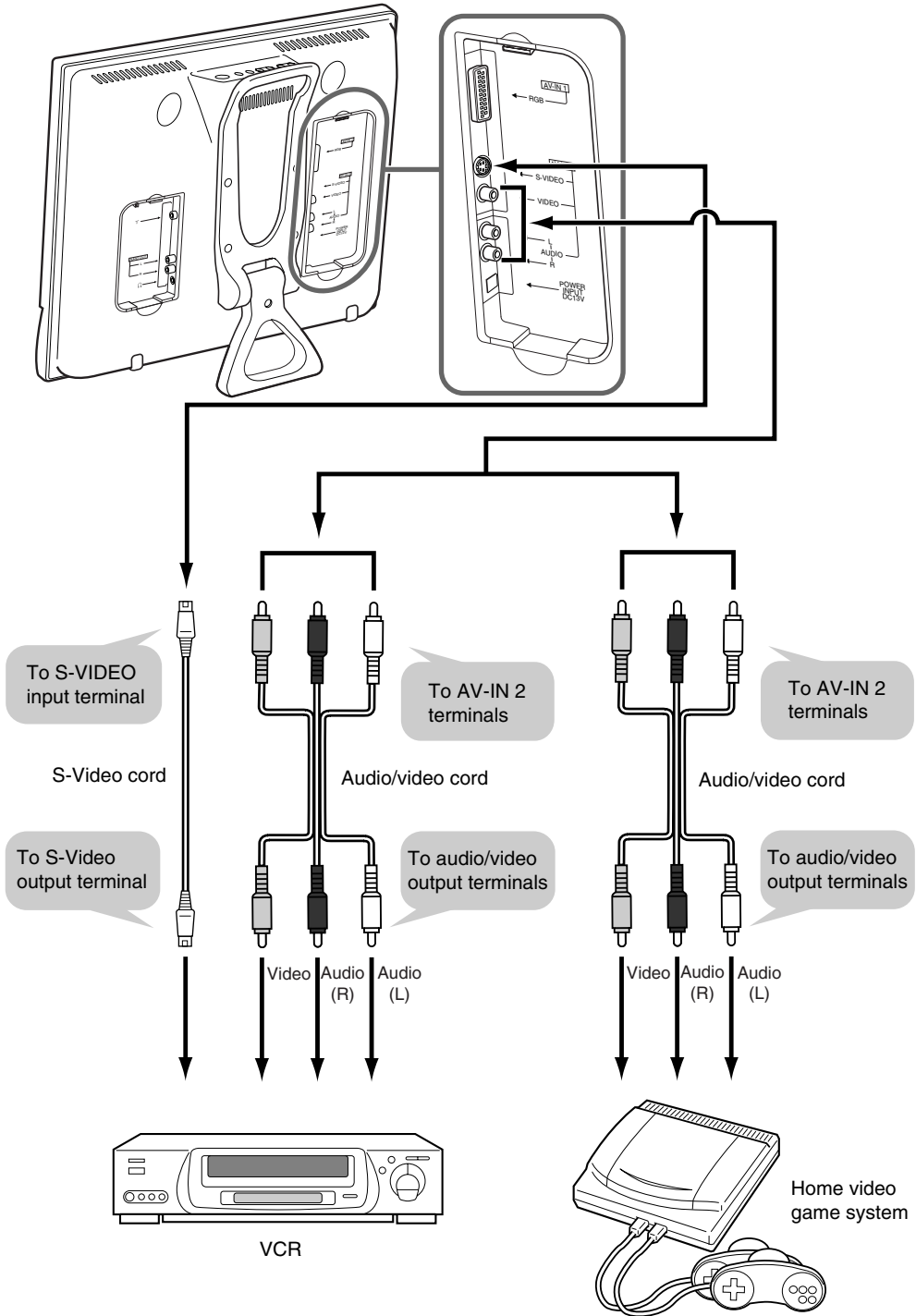

Note:

- When connecting to both the VIDEO input and S-VIDEO input terminals for AV-IN 2, priority is given to the S-VIDEO input terminal.

Connecting External Devices (Continued)

Outputting audio (AUDIO OUT)

It is possible to output audio from the LCD TV set through the AUDIO OUT terminals.

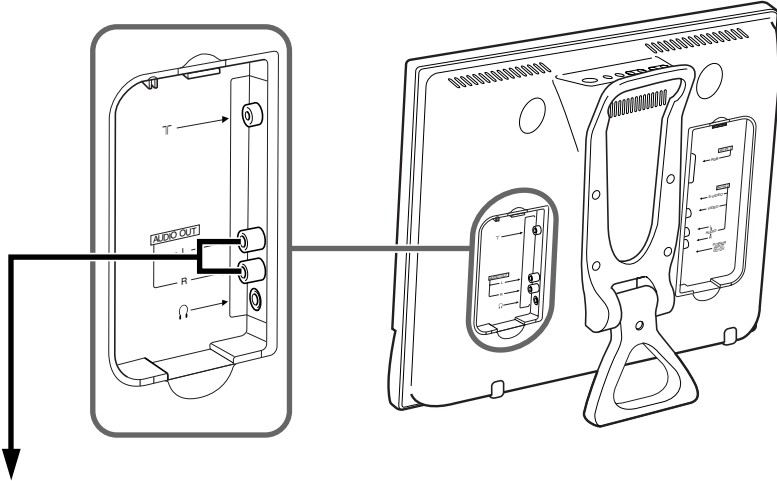

Connect an audio amplifier, etc.

How to fix the cables



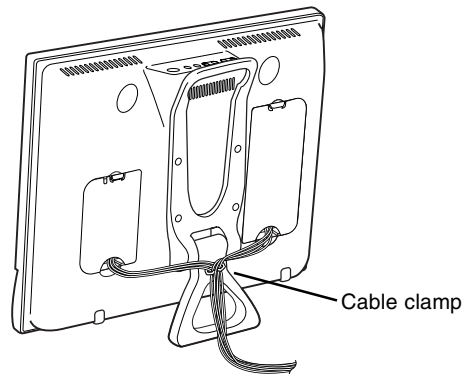



- Secure cables and cords with the supplied cable clamp so that they do not get caught when mounting the cover.

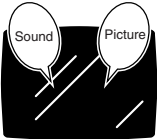
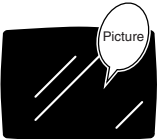

Troubleshooting

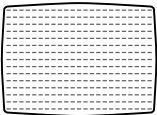



Before calling for repair services, make the following checks for possible remedies to the symptoms encountered.

LCD TV set

Problem	Check item	Reference page
 <p>There is no picture or sound.</p>	<ul style="list-style-type: none"> • Make sure the AC adapter is properly inserted in the power outlet. • Reception other than that of broadcasting stations could be the problem. • Make sure the input mode is set to TV. • Make sure the main power switch of the main unit is on. 	<p>6</p> <p>–</p> <p>12</p> <p>12</p>
 <p>There is no picture. There is no picture from AV-IN 2.</p>	<ul style="list-style-type: none"> • Make sure Picture adjustment is properly adjusted. • The fluorescent lamp may have reached the end of its service life. • Make sure the S-Video terminal has nothing connected. 	<p>17</p> <p>–</p> <p>45</p>
 <p>There is no sound.</p>	<ul style="list-style-type: none"> • Make sure the volume is not set to minimum. • Make sure the sound is not set to mute. • Make sure the headphones are not connected. 	<p>13</p> <p>13</p> <p>10</p>
 <p>There is no picture or sound, just noise.</p>	<ul style="list-style-type: none"> • Make sure the antenna cable is properly connected. • Bad reception could be the problem. 	<p>6</p> <p>–</p>
 <p>Picture is not clear.</p>	<ul style="list-style-type: none"> • Make sure the antenna cable is properly connected. • Bad reception could be the problem. 	<p>6</p> <p>–</p>
 <p>Picture is too light or improperly tinted.</p>	<ul style="list-style-type: none"> • Check the colour adjustment. (NTSC mode) 	<p>17</p>
 <p>The picture is too dark.</p>	<ul style="list-style-type: none"> • Check if "Brightness" is set to "dark". • Check "Contrast" and "Black level". • The fluorescent lamp may have reached the end of its service life. 	<p>27</p> <p>17</p> <p>–</p>
<p>Remote control does not work.</p>	<ul style="list-style-type: none"> • Check if batteries in the remote control have sufficient power. • Make sure the remote sensor window is not under strong lighting. 	<p>5</p> <p>5</p>

Troubleshooting (Continued)

Antenna

Problem	Check item
 <p>The picture is not sharp.</p>  <p>The picture shakes.</p>	<ul style="list-style-type: none"> • The reception may be weak. • The quality of the broadcast may also be bad. • Make sure the antenna is facing the correct direction. • Make sure the outside antenna has not been disconnected.
 <p>The picture has ghosts.</p>	<ul style="list-style-type: none"> • Make sure the antenna is facing the correct direction. • Broadcast waves may be reflected from adjacent mountains or buildings.
 <p>The picture is spotted.</p>	<ul style="list-style-type: none"> • There may be interference from automobiles, trains, high-voltage lines, neon lights, etc. • There may be interference between the antenna cable and power cable. Try positioning them further apart.
 <p>There are stripes on the screen or colours fade.</p>	<ul style="list-style-type: none"> • Is the unit receiving interference from other devices? Transmission antennas of radio broadcasting stations and transmission antennas of amateur radios and cellular phones may also cause interference. • Use the unit as far apart as possible from devices that may cause possible interference.

■ Use in hot and cold rooms (locations)

- When the unit is used in rooms (locations) with low temperature, the picture may leave trails or appear slightly delayed. This is not a malfunction, and the unit will recover when the temperature returns to normal.
- Do not leave the unit in a hot or cold location. Also, do not leave the unit in a location exposed to direct sunlight or near a heater, as this may cause the cabinet to deform and the LCD panel to malfunction.
(Storage temperature: -20°C to $+60^{\circ}\text{C}$)

Specifications

Items		13" LCD COLOUR TV, Model: LC-13E1E	15" LCD COLOUR TV, Model: LC-15E1E	20" LCD COLOUR TV, Model: LC-20E1E
LCD panel		Advanced Super View & BLACK TFT LCD		
LCD panel size		13"	15"	19.7"
Number of dots		921,600 dots		
Video colour system		PAL/SECAM/NTSC		
TV Function	TV-Standard (CCIR)	B/G, I, D/K, L		
	TV-Tuning System	Auto preset 200 ch.		
	STEREO/BILINGUAL	NICAM, IGR		
	AUTO PRESET	Yes		
	CATV	~Hyper Band		
Brightness		430 cd/m ²		
Lamp life		60,000 hours		
Viewing angles		H: 170° V: 170°		
Audio amplifier		2.1 W × 2		2.5 W × 2
Speakers		3× 7.5 cm 2 pcs.		4× 7 cm 2 pcs.
Terminals	AV-IN 1	RGB		
	AV-IN 2	S-VIDEO, VIDEO, AUDIO		
	OUT	AUDIO		
	Antenna	DIN		
	Headphones	3.5 mm ø jack (Rear)		
OSD language		English/German/French/Spanish/Italian/Swedish/Dutch		
Power requirement		DC 12 V, AC 110 V – 240 V, 50/60 Hz		DC 13 V, AC 110 V – 240 V, 50/60 Hz
Weight		3.8 kg	4.5 kg	7.1 kg
Accessories		Operation Manual, Remote Control, Batteries, AC adapter, AC cord, Cable clamp		

■ As a part of policy of continuous improvement, SHARP reserves the right to make design and specification changes for product improvement without prior notice. The performance specification figures indicated are nominal values of production units. There may be some deviations from these values in individual units.

Dimensional Drawings

LC-13E1E

Unit: mm

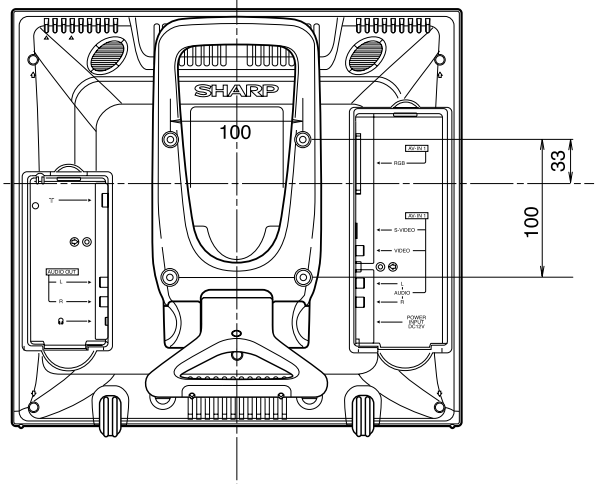
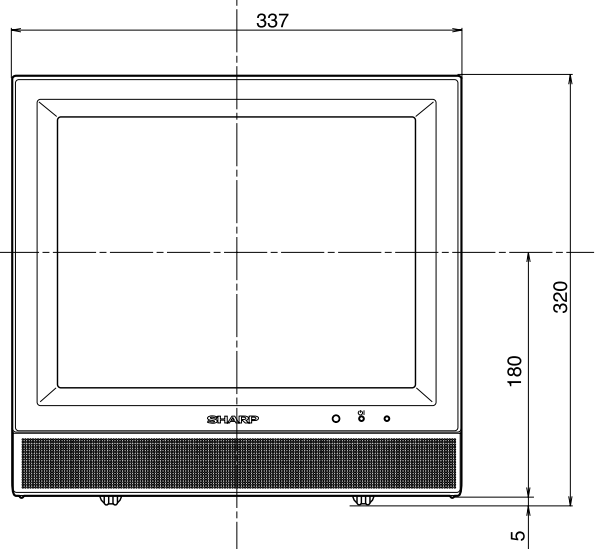
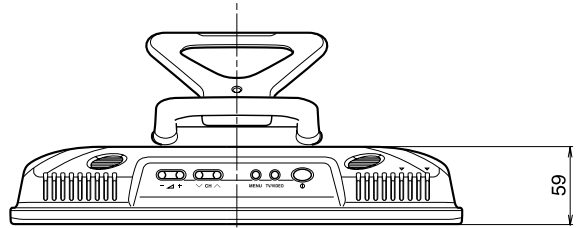
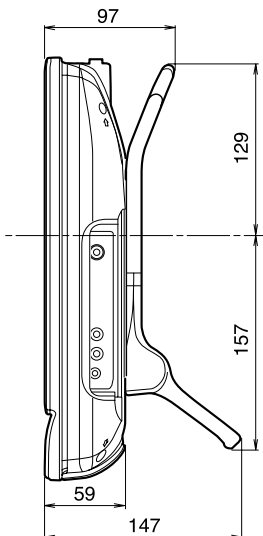
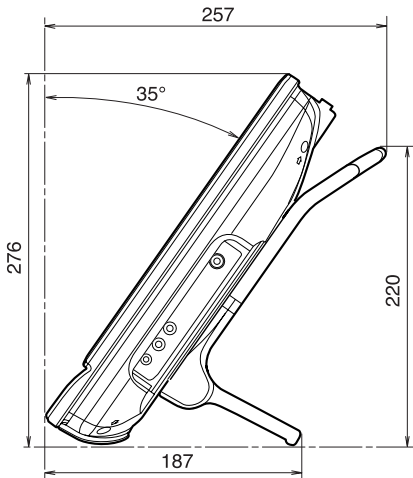
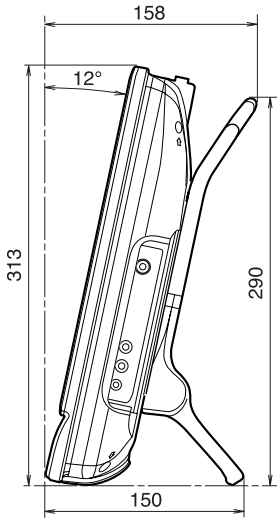

Dimensional Drawings (Continued)

LC-15E1E

Unit: mm

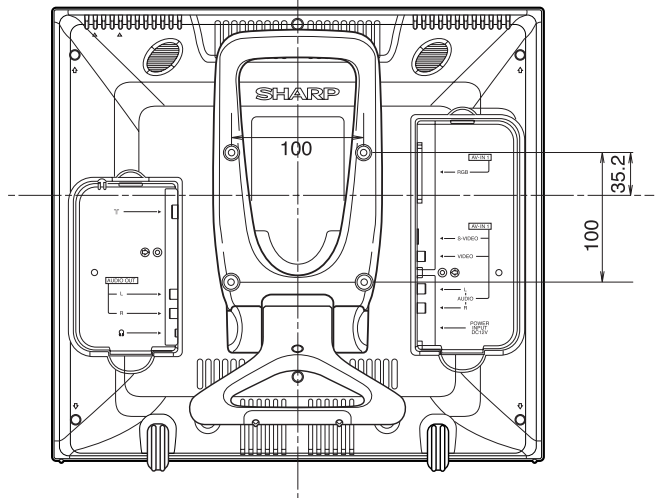
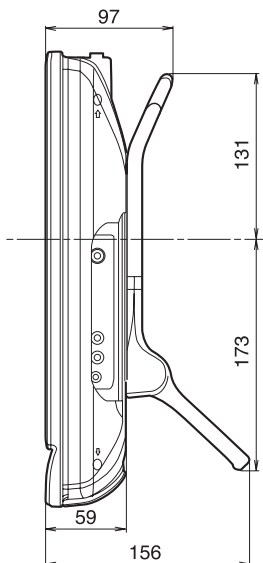
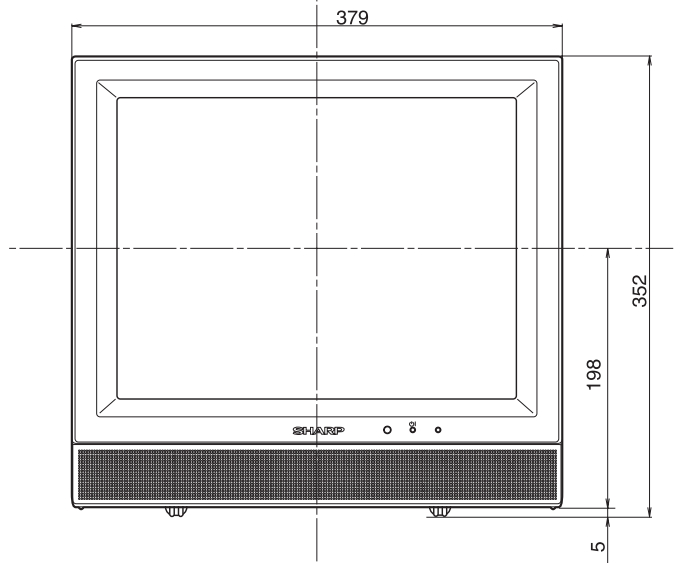
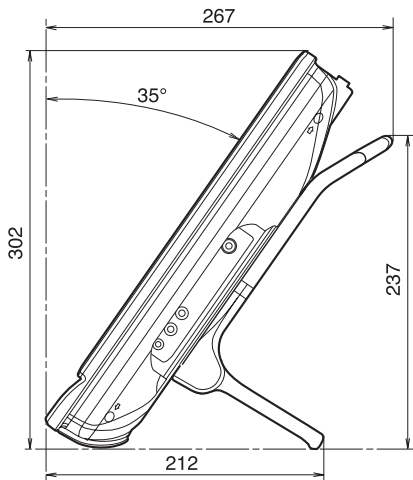
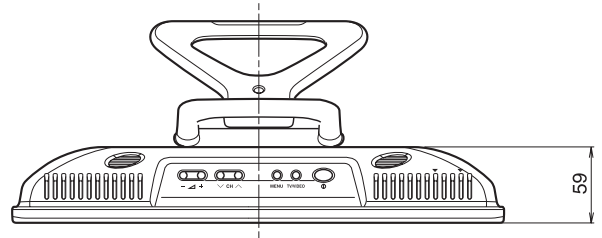
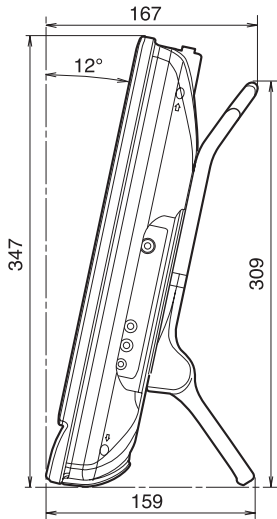

Dimensional Drawings (Continued)

LC-20E1E

Unit: mm

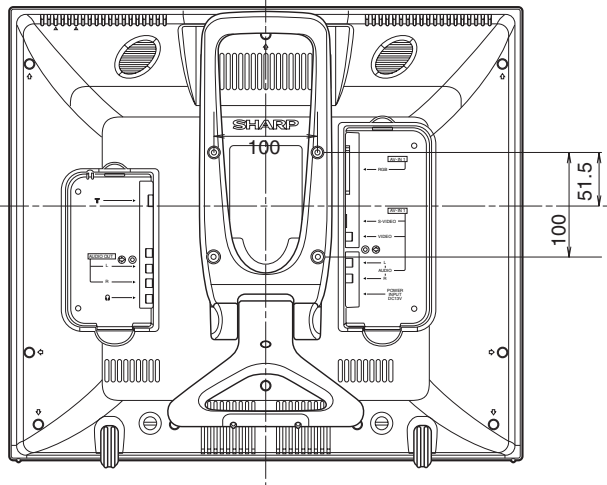
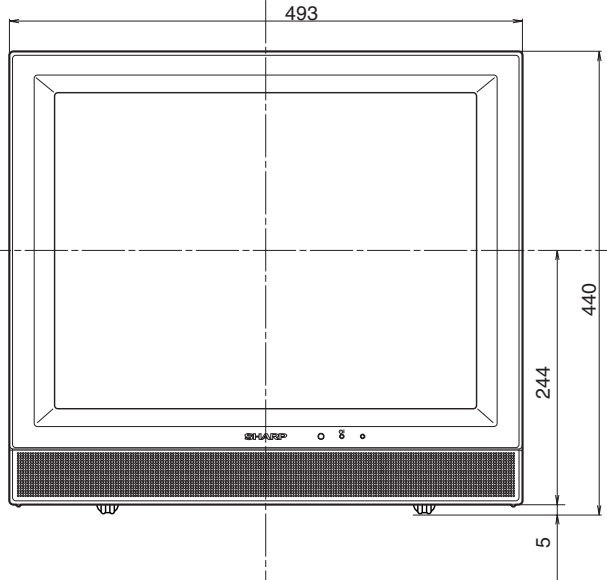
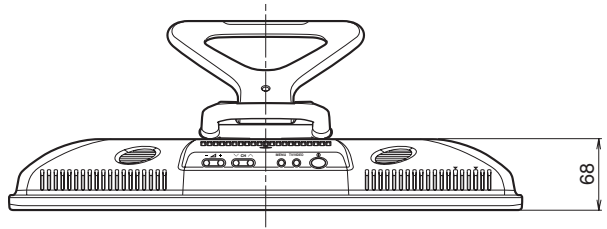
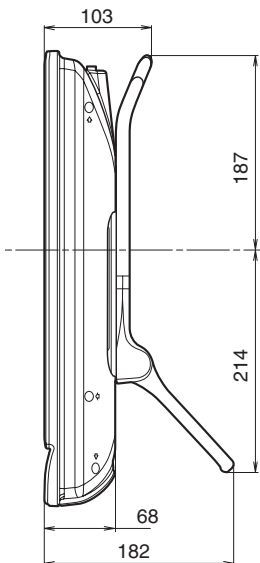
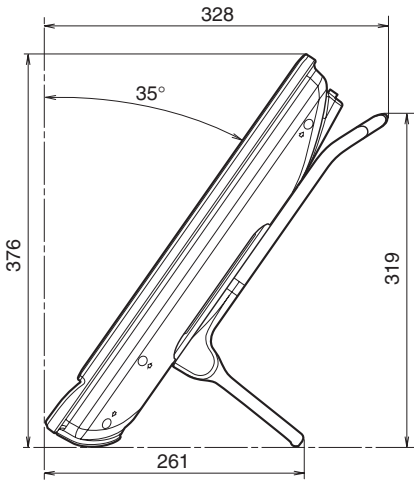
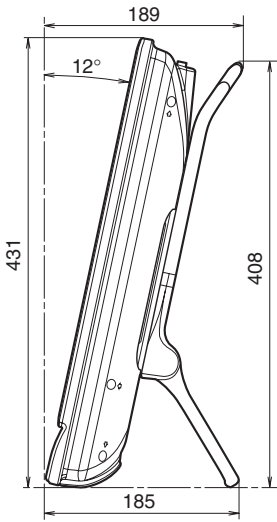

IMPORTANT NOTE ON DISENGAGING ADVANCED CHILD LOCK

We suggest removing the following instruction respectively with page GB 53 and GB 55. As this Operation Manual is multilingual, we also suggest the same with each language.

If you have forgotten your personal code number and cannot disengage ADVANCED CHILD LOCK, follow the procedure below.

1. Press **MENU** to display the TV menu.
2. Press **▲/▼** to select "Features", and then press **OK** to display the "Features" screen.
3. Press **▲/▼** to select "Child lock," then press **OK**.
4. The PIN input menu appears.
5. Input "3001" with **Channel Select**.
The Child lock setting menu appears and the PIN is cleared.
A new PIN can now be input.

ADVANCED CHILD LOCK will now be disengaged.

We suggest that you remove this instruction from the manual to prevent children from reading it. Keep it in a safe space for future reference.

**WICHTIGER HINWEIS ZUR AUFHEBUNG VON KINDERSICHERUNG "ADVANCED CHILD LOCK"**

Wir schlagen vor, die folgenden Instruktionen auf Seite GB 53 bzw. GB 55 in Englisch zu entfernen. Da diese Bedienungsanleitung mehrsprachig abgefasst ist, empfehlen wir den gleichen Vorgang auch für jede andere Sprache. Wenn Sie Ihre persönliche Codenummer vergessen haben und die Kindersicherung nicht aufheben können, so gehen Sie wie folgt vor.

1. Drücken Sie **MENU**, um das TV-Menü anzuzeigen.
2. Drücken Sie **▲/▼**, um "Funktionen" zu wählen, und drücken Sie dann **OK**, um das Bildschirm "Funktionen" anzuzeigen.
3. Drücken Sie **▲/▼**, um "Kindersicherung" zu wählen, und drücken Sie dann **OK**.
4. Der Bildschirm für PIN-Eingabe.
5. Geben Sie "3001" mit den **Kanalwahl** ein.
Der Bildschirm "Kindersicherung" erscheint und die PIN wird gelöscht.
Nun kann eine neue PIN eingegeben werden.

Die Kindersicherung wird nun aufgehoben.

Wir empfehlen, dass Sie diese Anweisung aus dem Handbuch entfernen, damit Ihre Kinder sie nicht lesen können. Bewahren Sie sie für spätere Bezugnahme an einem sicheren Platz auf.

**REMARQUE IMPORTANTE CONCERNANT LE DÉBLOCAGE DU VERROUILLAGE PARENTAL AVANCÉ**

Nous suggérons de retirer les instructions suivantes des pages GB 53 et GB 55 en anglais. Le mode d'emploi étant multilingues, il est suggéré aussi de le faire pour les autres langues.

Si l'on a oublié son numéro de code personnel et que VERROUILLAGE PARENTAL AVANCÉ ne peut pas être débloqué, suivre la procédure ci-dessous.

1. Appuyer sur **MENU** pour faire apparaître le menu de télévision.
2. Appuyer sur **▲/▼** pour choisir "Caracterisiques" et appuyer sur **OK** pour afficher la page-écran "Caraceristiques".
3. Appuyer sur **▲/▼** pour choisir "Sécurité enfants" et appuyer sur **OK**.
4. Ceci fait apparaître le menu de saisie du numéro PIN.
5. Saisir le numéro "3001" avec **Sélection de Chaîne**.
Le menu de paramétrage de sécurité enfants apparaît et le numéro PIN est effacé.
Un nouveau mot de passe peut alors être introduit.

VERROUILLAGE PARENTAL AVANCÉ est alors débloqué.

Nous suggérons de retirer cette instruction du mode d'emploi afin d'éviter que des enfants la lisent. La conserver en lieu sûr pour référence future.

**NOTA IMPORTANTE SULLA DISATTIVAZIONE DEL BLOCCO AVANZATO PER I BAMBINI**

Si suggerisce di rimuovere la seguente istruzione rispettivamente con la pagina GB 53 e GB 55 in inglese. Poiché questo Manuale di istruzioni è in versione multilingue, si suggerisce anche di fare la stessa cosa per ogni lingua.

Se si è dimenticato il proprio numero di codice personale e non è possibile disattivare il BLOCCO AVANZATO PER I BAMBINI, seguire il procedimento sotto.

1. Premete **MENU** per visualizzare il menu TV.
2. Premete **▲/▼** per selezione "Funzioni" e quindi premete **OK** per visualizzare il corrispondente schermo "Funzioni."
3. Premete **▲/▼** sino a selezionare "Sicura per bambini" e quindi premete **OK**.
4. Appare lo schermo relativo all'inserimento del PIN.
5. Con i tasti di **Selezione del Canale** inserite "3001."
Appare lo schermo relativo all'impostazione del blocco bambini, mentre il PIN viene cancellato.
Ora può essere immessa una password nuova.

Il BLOCCO AVANZATO PER I BAMBINI ora viene disattivato.

Si suggerisce di togliere questa istruzione dal manuale per evitare che i bambini la leggano. Conservarla in un posto sicuro per riferimenti in futuro.

AVISO IMPORTANTE SOBRE LA DESACTIVACIÓN DE LA PROTECCIÓN PARA NIÑOS AVANZADA

Se sugiere retirar las siguientes instrucciones respectivamente con las páginas GB 53 y GB 55 en inglés. Como este manual de manejo es multilingüe, también sugerimos lo mismo para cada idioma.

Si ha olvidado su número de código personal (PIN) y no puede desactivar la PROTECCIÓN PARA NIÑOS AVANZADA, siga el procedimiento siguiente.

1. Presione **MENU** para visualizar el menú de TV.
2. Presione **▲/▼** para seleccionar "Prestaciones" y luego presione **OK** para visualizar la pantalla de "Prestaciones."
3. Presione **▲/▼** para seleccionar "Restricción niños", luego presione **OK**.
4. Aparecerá el menú de ingreso del PIN.
5. Ingrese "3001" con **Selección de Canales**.

Aparecerá el menú de ajuste de protección para niños y el PIN será borrado.

Ahora se podrá introducir un número secreto nuevo.

Ahora LA PROTECCIÓN PARA NIÑOS AVANZADA se habrá desactivado.

Le sugerimos que retire esta instrucción del manual para evitar que los niños la lean. Guárdela en un lugar seguro para referencia futura.



VIKTIG ANMÄRKNING OM AVSTÄNGNING AV BARNLÅSET

Vi rekommenderar att följande anvisning samt sidan GB 53 och GB 55 på engelska avlägsnas. Då denna bruksanvisning är flerspråkig bör samma sak göras även för övriga språk.

Om du har glömt bort ditt lösenord så att du inte kan stänga av det AVANCERADE BARNLÅSET så gör på följande sätt.

1. Tryck på **MENU** för att visa TV-menyn.
2. Tryck på **▲/▼** för att välja "Egenskaper", och tryck sedan på **OK** för att visa skärmen "Egenskaper."
3. Tryck på **▲/▼** för att välja "Barnsäkring." och tryck sedan på **OK**.
4. Inmatningsskärmen för PIN visas.
5. Mata in "3001" med **Kanalväljarna**.

Inställningsmenyn för barnlåset visas och ditt tidigare PIN raderas.

Det går nu att mata in ett nytt PIN.

Därmed stängs det AVANCERADE BARNLÅSET av.

Vi rekommenderar att du tar bort denna anmärkning ur bruksanvisningen för att förhindra att barn får syn på den. Förvara anmärkningen på något säkert ställe för framtida bruk.



BELANGRIJKE OPMERKING OVER HET ANNULEREN VAN DE GEAVANCEERDE KINDERVERGREDELING

Wij suggereren het verwijderen van de volgende aanwijzing op respectievelijk pagina GB 53 en GB 55 in het Engels. Daar deze gebruiksaanwijzing meertalig wordt hetzelfde gesuggereerd voor de andere talen.

Wanneer u de kindervergrendeling niet kunt annuleren omdat u de pincode vergeten bent, dient u als volgt te werk te gaan.

1. Druk op **MENU** om het TV menu te openen.
2. Druk op **▲/▼**, selecteer "Eigenschappen" en druk vervolgens op **OK** om het "Eigenschappen" scherm te openen.
3. Druk op **▲/▼**, en selecteer "Kinderslot," en druk vervolgens op **OK**.
4. Het PIN invoerscherm verschijnt.
5. Voer "3001" in met de **Kanaal Keuzetoetsen**.

Het "Kinderslot" scherm zal nu verschijnen en uw oude PIN code zal zijn gewist.

U kunt nu een nieuwe PIN code invoeren.

De kindervergrendeling is nu geannuleerd.

Het is raadzaam dat u deze instructie uit de gebruiksaanwijzing verwijdert om te voorkomen dat deze door kinderen wordt gelezen. Bewaar deze instructie op een veilige plaats voor latere verwijzing.



SHARP®

SHARP CORPORATION

Printed on post-consumer recycled paper.
Gedruckt auf Nachverbraucher-Recyclingpapier.
Imprimé sur du papier recyclé.
Stampato su carta riciclata.
Impreso en papel reciclado.
Tryckt på slutkonsumerat återanvänt papper.
Gedruckt op na-verbruik recycled papier.

Printed in Japan
Gedruckt in Japan
Imprimé au Japon
Stampato in Giappone
Impreso en Japón
Tryckt i Japan
Gedruckt in Japan
TINS-A140WJZZ
02P07-JKM