



# USER MANUAL

## SE32HY01UK LED TV



En

---

**Read the User Manual carefully before using the TV  
and keep it for further reference.**

# CONTENTS

<b>Important Safety Instructions</b>	<b>2</b>	<b>Parental Control</b>	<b>31</b>
<b>Safety Information</b>	<b>3</b>	<b>Digital Reception</b>	<b>32</b>
<b>Preparation</b>	<b>4</b>	<b>Supported file formats</b>	<b>32</b>
What is Included	4	<b>Troubleshooting</b>	<b>33</b>
Front View	5	<b>Plug Replacement-UK and Ireland only</b>	<b>34</b>
Rear View	6	<b>Specifications</b>	<b>35</b>
Installing the Base Stand	7	<b>Disposal Information</b>	<b>35</b>
Removing the Stand for Wall-Mounting	7	<b>Limited Warranty</b>	<b>36</b>
Remote Control	8		
<b>Connecting External Devices</b>	<b>10</b>		
<b>Getting Started</b>	<b>11</b>		
Initial set up	11		
General operation	11		
<b>Basic Features</b>	<b>12</b>		
How to Navigate menus-Selecting Source	12		
Electronic Programme Guide (EPG) (DTV Mode)	12		
Teletext (ATV Mode)	13		
Digital Teletext (DTV Mode)	14		
Time Shift Function (DTV Mode)	15		
Recording DTV Programme onto a USB Storage Device	15		
Timer Programming	16		
Play Recorded Programme	16		
Picture Management(ATV/DTV Mode)	17		
Sound Management	18		
Channel Management (ATV / DTV Mode)	19		
Lock System management	23		
Setup management	23		
<b>Entertainment</b>	<b>28</b>		
Viewing Photo	28		
Listening to Music	29		
Viewing Movies	29		
My Text	30		

## IMPORTANT SAFETY INSTRUCTIONS

- **Read these instructions** – All the safety and operating instructions should be read before this product is operated.
- **Keep these instructions** – The safety and operating instructions should be retained for future reference.
- **Heed all warnings** – All warnings on the appliance and in the operating instructions should be adhered to.
- **Follow all instructions** – All operating and use instructions should be followed.
- **Do not use this apparatus near water** – The appliance should not be used near water or moisture – for example, in a wet basement or near a swimming pool.
- Clean only with dry cloth.
- Do not block any ventilation openings. Install in accordance with the manufacturer's instructions.
- Do not install near any heat sources such as radiators, heat registers, stoves, or other apparatus (including amplifiers) that produce heat.
- Do not defeat the safety purpose of the polarized or grounding plug. A polarized plug has two blades with one wider than the other. A grounding plug has two blades and a third grounding prong. The wide blade or the third prong is provided for your safety. If the provided plug does not fit into your outlet, consult an electrician for replacement of the obsolete outlet.
- Protect the power cord from being walked on or pinched particularly at the plugs, convenience receptacles, and at the point where they exit from the apparatus.
- Only use attachments/accessories specified by the manufacturer.
- Use only with the cart, stand, tripod, bracket, or table specified by the manufacturer, or sold with the apparatus. When a cart or rack is used, use caution when moving the cart/apparatus combination to avoid injury from tip-over.
- Unplug the apparatus during lightning storms or when unused for long periods of time.
- Refer all servicing to qualified personnel. Servicing is required when the apparatus has been damaged in any way, such as the power supply cord or plug is damaged, liquid has been spilled, or objects have fallen into the apparatus, or the apparatus has been exposed to rain or moisture, does not operate normally, or has been dropped.
- Please keep the unit in a well-ventilated environment.
- **WARNING:** To reduce the risk of fire or electric shock, do not expose this apparatus to rain or moisture. The apparatus should not be exposed to dripping or splashing. Objects filled with liquids, such as vases should not be placed on the apparatus.
- **WARNING:** The batteries shall not be exposed to excessive heat such as sunshine, fire or the like.
- **WARNING:** The wall socket plug is used as disconnect device, the disconnect device shall remain readily operable.



- This lightning flash with arrowhead symbol within an equilateral triangle is intended to alert the user to the presence of non-insulated "dangerous voltage" within the product's enclosure that may be of sufficient magnitude to constitute a risk of electric shock.
- **Warning:** To reduce the risk of electric shock, do not remove cover (or back) as there are no user-serviceable parts inside. Refer servicing to qualified personnel.
- The exclamation point within an equilateral triangle is intended to alert the user to the presence of important operating and maintenance instructions in the literature accompanying the appliance.



This equipment is a Class II or double insulated electrical appliance. It has been designed in such a way that it does not require a safety connection to electrical earth.

- **Warning: To prevent the spread of fire, keep candles or other open flames away from this product at all times.**

## SAFETY INFORMATION



This product contains electrical or electronic materials. The presence of these materials may, if not disposed of properly, have potential adverse effects on the environment and human health. Presence of this label on the product means it should not be disposed of as unsorted waste and must be collected separately. As a consumer, you are responsible for ensuring that this product is disposed of properly.



This TV incorporates High-Definition Multimedia Interface (HDMI™) technology. HDMI, the HDMI logo and High-Definition Multimedia Interface are trademarks or registered trademarks of HDMI Licensing LLC.

To ensure reliable and safe operation of this equipment, please carefully read all the instructions in this user guide, especially the safety information below.

### Electrical Safety

- The TV set should only be connected to a main power supply with voltage that matches the label at the rear of the product.
- To prevent overload, do not share the same power supply socket with too many other electronic components.
- Do not place any connecting wires where they may be stepped on or tripped over.
- Do not place heavy items on any connecting wire, which may damage the wire.
- Hold the main plug, not the wires, when removing from a socket.
- During a thunderstorm, or when not using the television for extended period of time, turn off the power switch on the back of the television.
- Do not allow water or moisture to enter the TV or power adapter. Do NOT use in wet, moist areas, such as bathrooms, steamy kitchens or near swimming pools.
- Pull the plug out immediately, and seek professional help if the main plug or cable is damaged, liquid is spilled onto the set, if the TV set accidentally exposed to water or moisture, if anything accidentally penetrates the ventilation slots or if the TV set does not work normally.
- Do not remove the safety covers. There are no user-serviceable parts inside. Trying to service the unit yourself is dangerous and may invalidate the product's warranty. Qualified personnel must only service this apparatus.
- To avoid a battery leakage, remove batteries from the remote control, when the remote is not use for long period, or when the batteries are exhausted.
- Do not break open or throw exhausted batteries into a fire.

### Physical Safety

- Do not block ventilation slots in the back cover. You may place the TV in a cabinet, but ensure at least 5cm (2") clearance all around.
- Do not tap or shake the TV screen, or you may damage the internal circuits. Take good care of the remote control.
- To clean the TV use a soft dry cloth. Do not use solvents or petroleum based fluids.
- Do not install near any heat sources such as radiators, heat registers, stoves or other apparatus (including amplifiers) that produce heat.
- Do not defeat the safety purpose of the polarized or grounding-type plug. A polarized plug has two blades with one wider than the other. A grounding plug has two blades and a third grounding prong. The wide blade, or the third prong is provided for your safety. If the provided plug does not fit into your outlet, consult an electrician for replacement of the obsolete outlet.
- Protect the power cord from being walked on or pinched particularly at plugs.
- Unplug the apparatus during lightning storms or when unused for long periods.
- Refer all servicing to a qualified service personnel. Servicing is required if the apparatus does not operate normally or if the apparatus, including the power supply cord or plug, has been damaged in any way.
- Servicing is also required if liquid has been spilled, or objects have fallen into the apparatus; when the apparatus has been exposed to rain or moisture; or if the apparatus has been dropped.
- Always connect your television to a power outlet with protective ground connection.

# PREPARATION

## What is Included

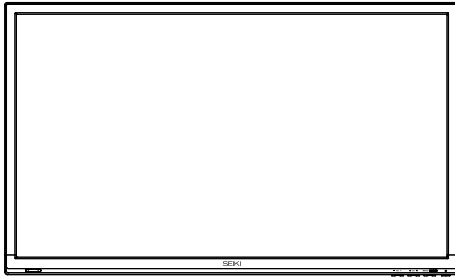

TV Set

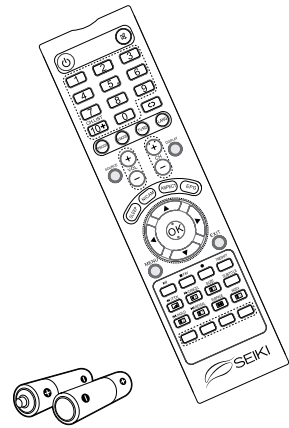

Remote control with Batteries

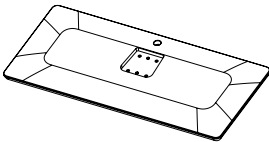

Base Stand



Stand Support

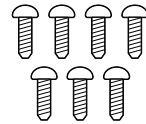

Seven Screws

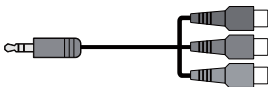

MINI YPBPR cable

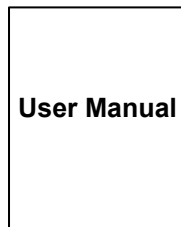

User Manual

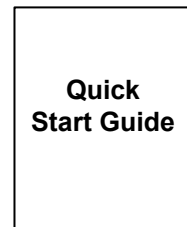

Quick Start Guide

## Front View

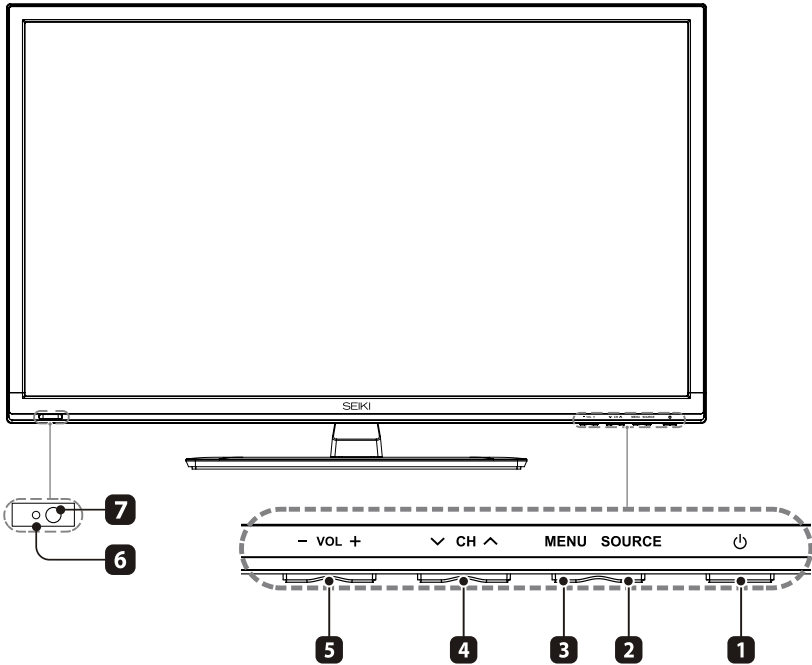

1. **Power Button**  
Switch the TV between On / Standby mode.
2. **Source**  
Press to select among different input signal sources.
3. **Menu**  
Display the OSD (on screen display) menu.
4. **Channel**  $\downarrow/\uparrow$   
Press to select a channel.
5. **Volume**  $-/+$   
Press to adjust the volume.
6. **POWER Indicator**  
Illuminate blue when the TV is turned on. Illuminate red when the TV is in standby mode.
7. **Infrared Receiver**  
Receive the IR signals from the remote control.

**Rear View**

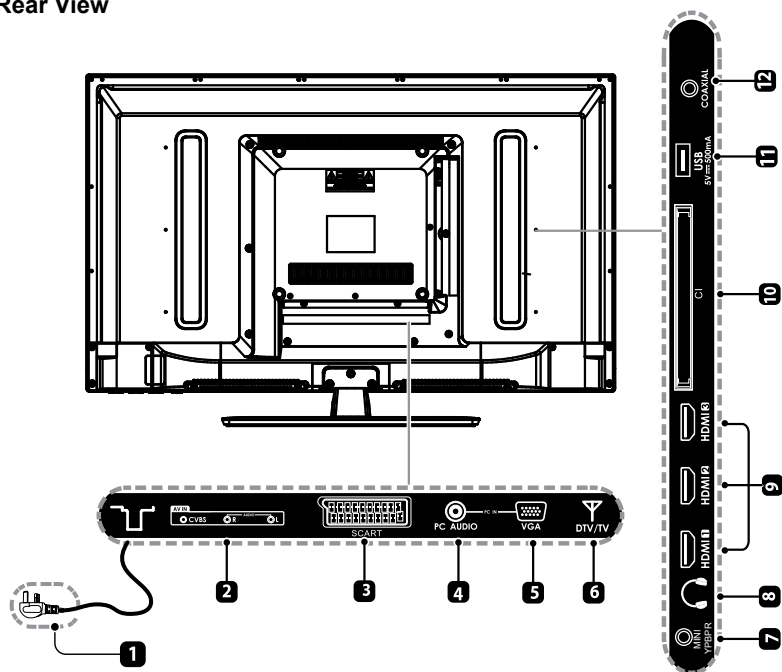

1. **Power Cord**  
Connect to AC power outlet.
2. **AV Input**  
Connect to the composite VIDEO and AUDIO (L/R) output sockets on external video devices.
3. **SCART Socket**  
Inputs or outputs for external devices. Connect the SCART cable between the SCART socket on the TV and the SCART socket on the external device(decoder,VCR or DVD player).
4. **PC AUDIO Input**  
Connect to a computer audio output.
5. **VGA Input**  
Connect to a computer or other devices with a VGA interface.
6. **DTV/TV Input**  
Connect to the antenna (75Ω VHF/UHF) socket with the RF coaxial cable.
7. **MINI YPBPR**  
YPBPR input socket is just suitable for YPBPR MINI cable. Connect to a DVD player,Digital Set-Top-Box,or other AV devices with component (YPBPR)video output sockets.
8. **Headphone Socket**  
Connect to the Headphones.
9. **HDMI Inputs**  
Connect to a High-Definition (HD) signal output device.
10. **CI Slot**  
Used to insert a CI card.A CI card allows you to view all the channels that you subscribe to.For more information,see "Conditional Access" section.
11. **USB Port**  
Connect to a USB storage device to play compatible audio and photo files. (USB mode)
12. **COAXIAL Digital Audio Output**  
Connect to the audio socket on the digital audio system.

## Installing the Stand

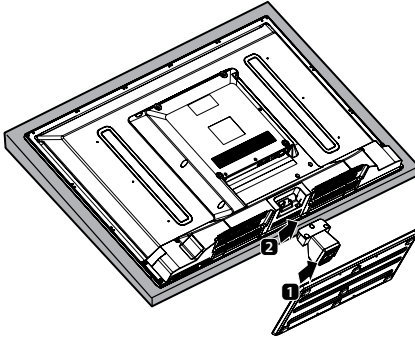

- 1. Lay the TV face-down on a flat, cushioned surface to avoid damaging or scratching.
- 2. Fix the stand support to the TV using the 4 pcs provided screws.
- 3. Fix the base stand to the TV using the 3 pcs provided screws.

## Removing the Stand for Wall-Mounting

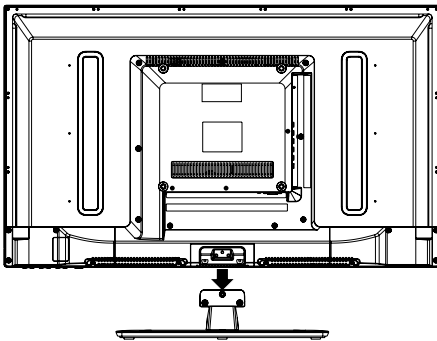

- 1. Lay the TV face-down on a flat, cushioned surface to avoid damaging or scratching.
- 2. Untighten the 3 pcs screws holding the stand assembly and remove them.
- 3. Attach the wall-mount bracket to the TV using the mounting holes on the back of the TV. Mount this TV according to the instructions included in the wall-mount bracket.

**WARNING:** This apparatus is intended to be supported by UL Listed wall mount bracket.





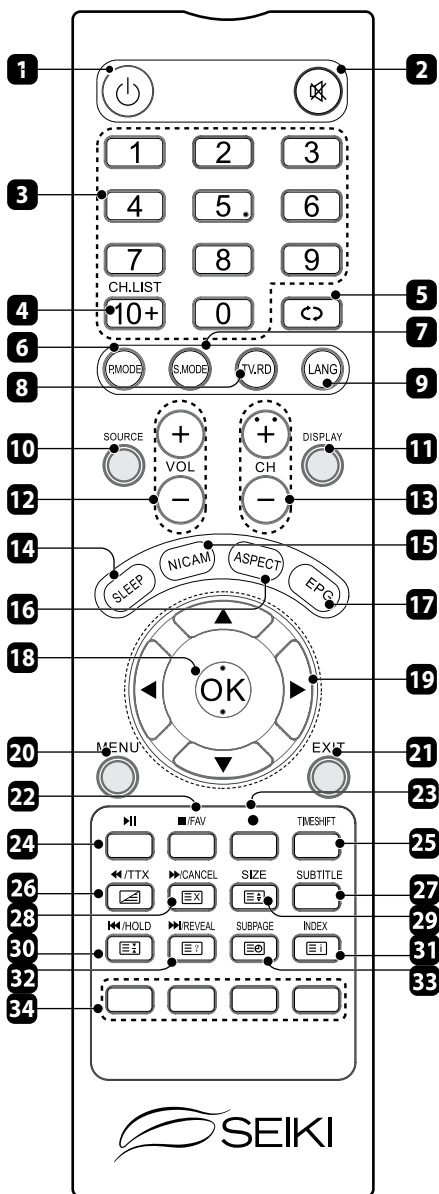



Remote Control



1. : Switch the TV between on and standby mode.
2. : Mute and restore your TV sound.
3. **0-9**: Select a program. (ATV/DTV mode)
4. **CH.LIST**: Display channel list.(ATV/DTV mode)
5. : Return to previous viewing channel.
6. **P.MODE**: Select picture mode: standard/mild/personal/dynamic.
7. **S.MODE**: Select sound mode: standard/music/movie/personal.
8. **TV.RD**: Select TV program or Radio program.(DTV mode).
9. **LANG**: Select DTV audio language.(DTV mode)
10. **SOURCE**: Select among the different input signal sources: DTV/ATV/SCART/AV/YPbPr/HDMI1/HDMI2/HDMI3/PC/USB.
11. **DISPLAY**: Display the present screen information such as the current channel and the input source.
12. **VOL +/-**: Adjust the volume.
13. **CH +/-**: Select a channel.
14. **SLEEP**: Set the TV sleep timer.
15. **NICAM**: Switch between different audio channels(only applicable when the TV programme has this feature).
16. **ASPECT**: Select from the following mode settings: 16:9/Zoom1/Zoom2/Auto/4:3.
17. **EPG**: Display the EPG(Electronic Program Guide).(DTV mode)
18. **OK**: Confirm the selection in the OSD 'on screen display' menus.
19. : Allows you to navigate the OSD menu and adjust the system settings to your preference.
20. **MENU**: Display the OSD 'on screen display' menu.
21. **EXIT**: Exit the OSD menu.
22. : Press to stop the playback, the time shift or the recording. (USB/DTV mode).  
**FAV**: Display the Favourite Channel list. (ATV/ DTV mode)
23. : Record the current programme.(DTV mode)
24. : To start or pause the timeshift playback. (DTV mode)  
To start playback or pause.(USBmode)

---

**Remote Control**

25. **TIMESHIFT**: Start the time-shift function.(DTV mode)
26.  **TTX**: Turn on and off the Teletext function.(ATV/DTV/AV/SCART mode)
  - ◀◀: To reverse playback rapidly.(USB/DTV mode)
27. **SUBTITLE**: Display the subtitle which is broadcast with the program.(DTV mode)
28.  **CANCEL**: To cancel the teletext mode.(ATV/DTV/AV/SCART mode)
  - ▶▶: To advance playback rapidly.(USB/DTV mode)
29.  **SIZE**: To enlarge the picture on the TV in teletext.(ATV/DTV/AV/SCART mode)
30.  **HOLD**: Freezes a multi-page passage on screen in teletext.(ATV/DTV/AV/SCART mode)
  - ◀◀: To skip to the beginning of the previous chapter/track/photo.(USB mode)
31.  **INDEX**: To select the page number of the index from teletext.(ATV/DTV/AV/SCART mode)
32.  **REVEAL**: Reveals hidden information such as the answer to a quiz in teletext.  
(ATV/DTV/AV/SCART mode)
  - ▶▶: To skip to the beginning of the next chapter/track/photo.(USB mode)
33.  **SUBPAGE**: Display the subpage on the teletext screen.(ATV/DTV/AV/SCART mode)
34. **Coloured buttons**: Press the button to select the corresponding function on the screen.  
(ATV/DTV/AV/SCART mode)

# CONNECTING EXTERNAL DEVICES

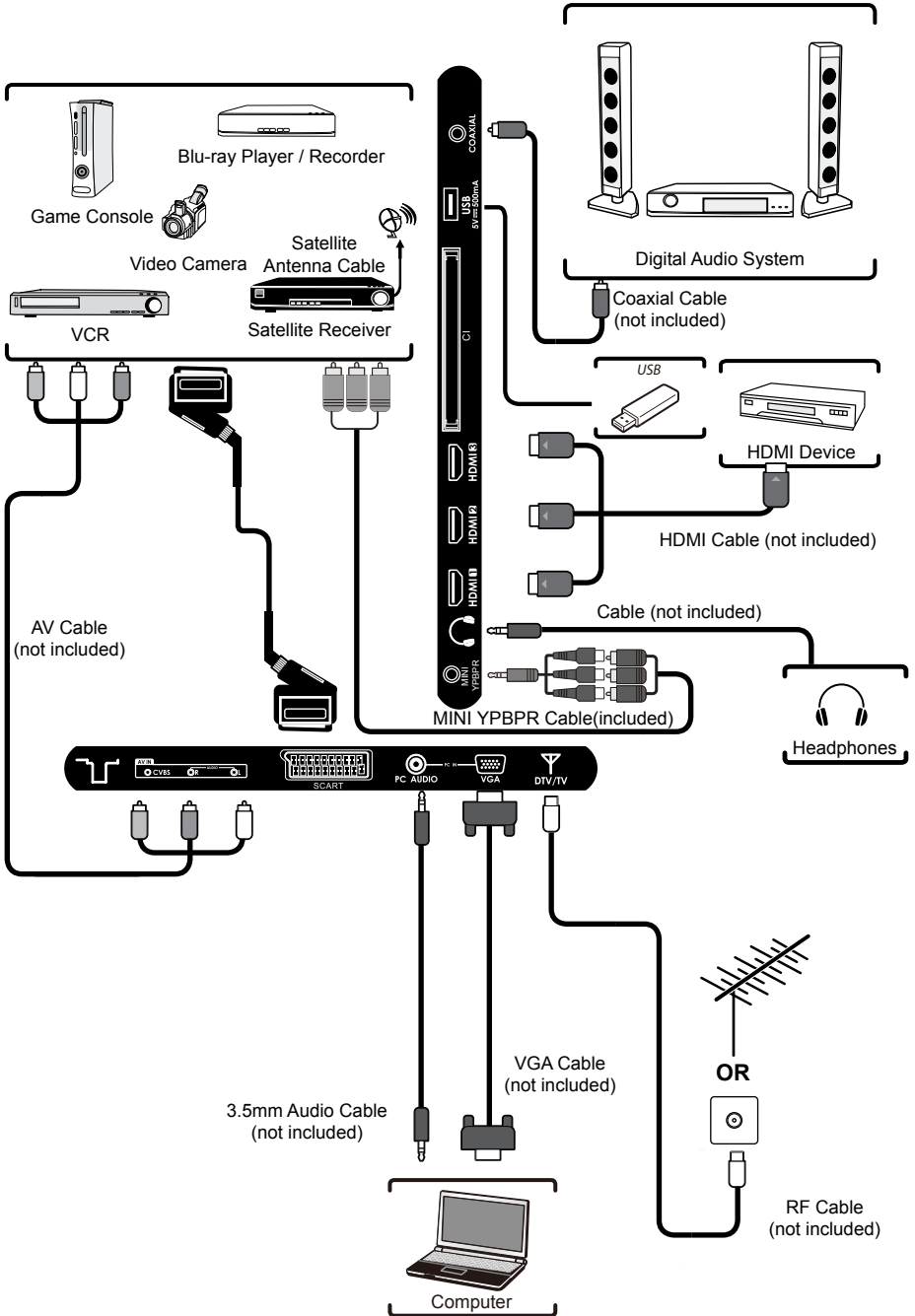

# GETTING STARTED

## Initial Setup

1. Connect one end of the RF coaxial cable to the aerial socket on the wall and the other end of the cable to the RF (75Ω) socket at the rear of your TV.
2. Connect the mains cable to the mains socket after you have completed all the connections.
3. Connect AC power cable. At this stage, the TV switches to standby mode. The red LED indicator will illuminate on the front panel of the TV.
4. In standby mode, press the **⏻** button on the bottom of the TV, or the **⏻** button on the remote control to turn the TV on. The red LED indicator will turn blue.
5. The first time you turn the TV on, it will go straight into **First Time Setup** menu. Press the **◀▶▲▼** buttons to navigate the menu and change the settings.

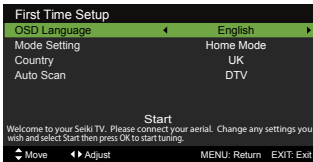

### OSD Language

Selects your desired language to be displayed on the menu. The default on-screen menu language is set as English.

### Mode Setting

Selects your desired mode setting.

- Home Mode: Viewing at home.
- Store Mode: For store demo, the brightness is higher than home mode.

### Country

Selects the country where you will operate the TV. The default country is set as UK.

### Auto Scan

Selects the auto scan type: DTV+ATV / DTV /ATV.

### Start

Press the **OK** button to start auto tuning. Auto Scan will commence. The display will show the progress of the tuning and the number of channels found.

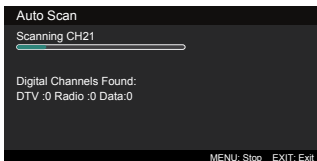

6. If you want to stop the DTV tuning, press the **MENU** button to interrupt the tuning half way.

## General Operation

Press the **SOURCE** button on the remote control and select DTV to switch the TV to Digital Terrestrial Television Broadcasting.

### Information Banner

Whenever you change channel using the **CH+**/**CH-** buttons or the number buttons, the TV displays the broadcast picture along with an information banner on the top left of the screen (available only in DTV/ATV mode).

The information banner can be displayed at any time while watching TV by pressing the **DISPLAY** button on the remote control.

# BASIC FEATURES

## How to Navigate Menus - Selecting Source

1. Press the **SOURCE** button at the bottom of the TV or the **SOURCE** button on the remote control to display the Input source list.
2. Press the **▲▼** buttons to select the input source that you want: DTV / ATV / SCART / AV / YPbPr / HDMI1 / HDMI2 / HDMI3 / PC / USB.
3. Press **OK** button to confirm your selection.

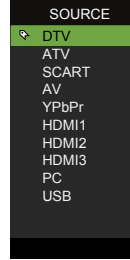

## Electronic Programme Guide (EPG) (DTV Mode)

This system has an Electronic Programme Guide (EPG) to help you navigate through all the possible viewing options.

The EPG supplies information such as programme listings, start and end times for all available services. In addition, detailed information about the programme is often available in the EPG (the availability and amount of programme information will vary, depending on the particular broadcaster).

This function can be used only when the EPG information is broadcast by broadcasting companies.

The EPG displays the programme details for the next 7 days.

1. Press the **EPG** button to switch on EPG.



2. Press **EPG** button or **EXIT** button again to switch off EPG and return to normal TV viewing.

*Info bar commands:*

**RED** (Prev. Date)

Press the **RED** button to view the schedule of the previous day.

**GREEN** (Next Date)

Press the **GREEN** button to view the schedule of the next day.

**YELLOW** (Schedule)

Press the **YELLOW** button to view the preset reminders in the schedule list. Press the **YELLOW** button to return to the EPG.

**BLUE** (Reminder)

Press the **BLUE** button while on the selected programme, the Reminder setting menu will be displayed.

Press the **▲▼◀▶** buttons to adjust the settings and then press the Save button to confirm the settings. After confirmation, the EPG Schedule List will then be displayed with your preset reminders shown. Press the **YELLOW** button to return to the EPG. The TV will automatically tune to the selected programme when it starts.

**REC**

Timer Programming.

## Teletext (ATV Mode)

Teletext is a free service broadcast by some TV stations which gives up-to-the-minute information on news, weather, television programmes, share prices and many other topics. Using the Teletext control buttons you can view pages of information that are listed in the teletext index.

### To Turn on Teletext Function



Make sure the TV channel you are watching transmits teletext.  
"No Teletext" sign will show on the screen if teletext is not available.

In ATV mode, press the **TTX** button to enter Teletext mode. Press the **INDEX** button to display the index page.

Press the **TTX** button once to exit and the TV will return to the channel you were watching.

### To select a page of text

Find the number of the page in the index and enter it using the **0-9** buttons. The number of the page will appear on the top left corner of the screen.

The page counter will search for your page. When it finds it, the page will be displayed.

To move to the next page of text, press the **▲** button.

To move to the previous page, press the **▼** button.

To return to the index page, enter the **"100"** by using the **0-9** buttons or press the **INDEX** button.

### Mix

To view a page of text while watching a TV programme, press the **TTX** button twice. The text will be superimposed over the TV programme.

### Double height text

If you have difficulty reading the text on the TV you can double the height of the text.

Press the **SIZE** button. The top half of the page will be displayed in double height text.

Press the **SIZE** button again. The bottom half of the page will be displayed in double height text.

Press the **SIZE** button again to return to the full page.

### Page HOLD

If the page of text you have selected contains subpages, these subpages will automatically be displayed in order with a delay to allow you to have enough time to read the page.

To stop moving to the next sub page, press the **HOLD** button.

To continue moving through the sub pages, press the **HOLD** button again.

*Alternative: Press the **SUBPAGE** button, and then use the 0-9 buttons to enter a 4-digit page number.*

### To Reveal Information

Press the **REVEAL** button to reveal concealed information (quiz answers etc.).

Press the **REVEAL** button again to conceal the information again.

### Fasttext

At the bottom of the teletext screen is a row of subject headings in red, green, yellow and blue.

The remote control has a row of colour buttons corresponding to the row of coloured subjects on the screen.

Pressing one of the colour buttons will take you directly to the page corresponding to the subject heading.



## Digital Teletext (DTV Mode)

Digital teletext can access special digital teletext services and specific services which broadcast digital teletext. You will need to turn off Subtitle Function before using teletext.

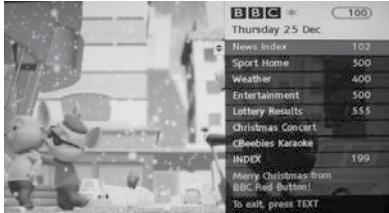
1. In DTV mode, press the  **TTX** button to display the teletext page.



2. Press the **0-9** buttons to select a page number.
3. Follow the instructions on digital teletext and move onto the next step by pressing **OK**, **▲▼**, **◀▶**, **RED**, **GREEN**, **YELLOW**, **BLUE** or **0-9** buttons etc.
4. To change digital teletext service, select a different service by pressing the **0-9** buttons or the **▲▼** buttons.

*Alternative: You may press the **RED** button to the  **TTX** button to display the teletext information when you see a  red logo displayed on the screen (e.g. BBC).*

5. Press the  **TTX** button to exit.

## Time Shift Function (DTV Mode)

This function allows the TV to virtually record the live viewing broadcast programme.

**Note:** If the transfer rate of the USB storage device is too slow for recording or time shift function, a warning statement will be shown on the screen. If this happens, please upgrade your USB storage device.



- Time Shift Mode and Recording functions may not work if the signal strength is weak.
- Stop the time-shift function before switching to another input source.

During normal TV viewing, you may press the **TIMESHIFT** button to virtually pause the live viewing broadcast programme if you want to go out for a while (e.g. going to the bathroom / kitchen). "II" will show on the screen.

When you have returned, press the **▶▶** button to display the PVR Time Shift progress bar and then press the **◀▶** buttons to select "▶" on the bar. Press the **OK** button to play the missed broadcast programme. "▶" will show on the screen.

The video and sound may have a little bit of delay or be out-of-sync for a few seconds when the unit starts to playback the missed broadcast

programme. It will soon turn to normal.

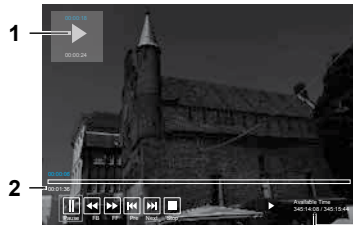

### The 'PVR Time Shift Progress Bar'

- 1 Indicates the status of the currently displayed video (▶ / || / ◀▶ ▶▶)
- 2 Indicates the time lagging behind the live broadcast (PVR reviewing)
- 3 Indicates the available recording time on your USB storage device

## Time Shift Function (DTV Mode)

### Using the Remote Control

You can shift playback to any point of the virtually recorded programme. Press the **TIMESHIFT** button to display the PVR Time Shift progress bar again.

#### TIMESHIFT

During playback, press the **TIMESHIFT** button to display a still screen.

◀◀ or ▶▶

When playing,

- Press the ◀◀ button repeatedly to speed up ◀◀ x 2 / x 4 / x 8 / x 16.
- Press the ▶▶ button repeatedly to speed up ▶▶ x 2 / x 4 / x 8 / x 16.
- During fast forward / fast backward state, press the ▶|| button to return to normal playback.

◀◀ or ▶▶

- Press the ▶▶ button to jump about 10% forward.
- Press the ◀◀ button to jump about 10% back.

▶||

• During playback, press the ▶|| button to display a still screen and then press the ▶|| button again to resume playback.

• During fast forward / fast backward state, press the ▶|| button to return to normal playback.

OK / ■

If you want to exit the PVR Time Shift progress bar and return to the current live broadcast, press the OK / ■ button and then press the ◀ button to confirm.

## Recording DTV Programme onto a USB Storage Device

Use this function to record the DTV programme you are watching on the main screen and save it for future viewing. The recording from timer programme or direct recording may have a little bit of delay when it starts to record the broadcast programme.

Please make sure the USB device is inserted. If not, a warning message will pop up.

1. Press the ● **REC** button to record the programme that you are currently watching.



To display the recording information, press the ● REC button.

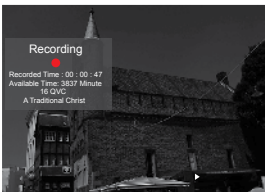

2. Press the ■ Stop button to stop recording.



Recording will stop automatically when the disk is full.



- If a hard disk is used, make sure its mains adapter is connected to the mains supply.
- If a USB hub is used, make sure its mains adapter is connected to the mains supply as the total current consumption may exceed 500mA.
- The maximum supported storage space of the hard disk is 1 TB.
- The file system only supports FAT32 format.
- If you want to store the video streaming of a DTV programme, the transfer rate of the USB storage device must not be less than 5MB/s, otherwise the picture and sound of the programme will be affected and a warning statement will be shown on the screen. If this happens, please upgrade your USB storage device.
- The TV screen will be blank temporarily as it will take time to start up and stabilise the connected hard disk. This is normal and the starting time may vary depending on the brand and the memory size of the connected hard disk.
- Disconnect the USB storage device if it is not in use.



## Timer Programming

This function is used for scheduled recording.

The recording from timer programme or direct recording may have a little bit of delay when it starts to record the broadcast programme.

Please make sure the USB device is inserted. If not, a warning message will pop up.

1. Press the **EPG** button on the remote control. The **EPG** menu will appear.



2. Press the **(REC)** button on the remote control while on the selected programme, the **Scheduled Record** menu will be displayed. Press the **▲▼◀▶** buttons to select the settings in the **RECORD** menu for the Frequency, Channel, Start time, and End time.

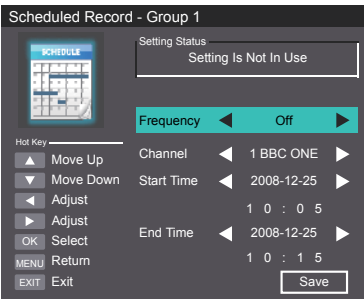

### Frequency

Press the **◀▶** buttons to select the frequency (Off/Once / Daily / Weekly / Weekday).

### Channel

Press the **OK** button and then press the **▲▼** buttons to select the channel that you want to record.

**Start time** (for Mode Once, Daily, Weekly, Weekday) Press the **▲▼◀▶** buttons to adjust the start time.

**End time** (for Mode Once, Daily, Weekly, Weekday) Press the **▲▼◀▶** buttons to adjust the end time.

3. After finishing all the recorder adjustments, press the **Save** button to confirm your settings.

4. The **Scheduled Record Setting List** will then be displayed with your preset reminders shown.

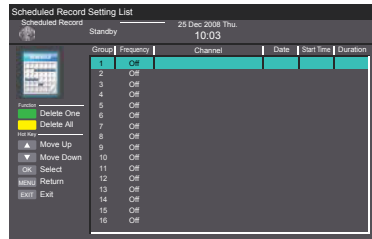

5. Press the **EXIT** button to exit EPG.



- When the preset time is reached, the TV will start recording automatically.
- If a programme recording starts when the TV is in standby mode, the LED indicator will alternatively flash red and blue.

## Play Recorded Programme

You can play a recorded programme from the recorded programme list or from a USB Storage Device.

1. Press the **SOURCE** button on the bottom of the TV or the **SOURCE** button on the remote control then press the **▲▼** buttons to select the **USB** mode and then press the **OK** button.
2. Press the **◀▶** buttons to select **MOVIE** and then press the **OK** button.

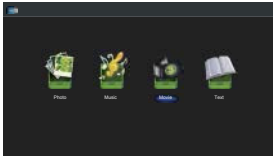

3. Press the **▲▼** buttons to select your storage device and then press the **OK** button.

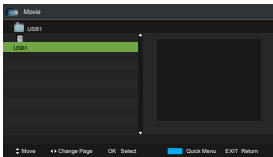

4. Press the **▲▼** buttons to select the "usbrecord" folder and then press the **OK** button.

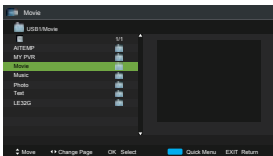

5. Press the **▲▼** buttons to select your recorded programme and then press the **▶▶** button to view.

## Play Recorded Programme

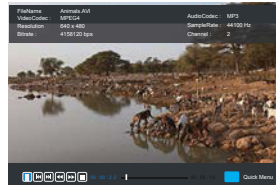

6. Press the **OK** button or the **DISPLAY** button to display the function bar. Press the **◀▶** buttons and then press the **OK** button to select the function: Pause / Prev. / Next / FB / FF / Stop / Quick Menu (Repeat / Encode Type).
7. Press the **EXIT** button to return to the previous menu.

## Picture Management (ATV/DTV Mode)

1. Press the **MENU** button to display the main menu. Press the **◀▶** buttons to select **Picture** in the main menu, then press the **▼** or **OK** button, it will highlight the first option.
2. Press the **▲▼** buttons to select the option you want to adjust in Picture menu.
3. Press the **◀▶▲▼** buttons to change the following settings.

### TIPS:

- You can change the value of brightness, contrast, sharpness and saturation when the picture is in Personal mode.
- You can press **P.MODE** button on the remote control to change the Picture Mode directly.

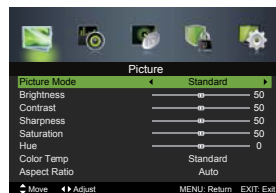

## Picture Management (ATV/DTV Mode)

### Picture Mode

Allows the selection of a picture-enhancement technical from among the following options: Dynamic / Standard / Mild / Personal.

### Brightness

This item can adjust the optical fiber output of the entire picture; it will affect the dark region of the picture.

### Contrast

This item can adjust the highlight intensity of the picture, but the shadow of the picture is invariable.

### Sharpness

This item can adjust the peaking in the detail of the picture.

### Saturation

This item can adjust the saturation of the color based on your own like.

### Hue

This item may use in compensating color changed with the transmission in the NTSC mode.

### Color Temp

This item can increase or reduce warm color of the picture personally (red), and the cold color (blue) according to your like. The choice of Cold, that means it will increase the blue tone for the white. But choosing the Warm, it will increase the red color for the white.

### Aspect Ratio

Allows you to watch the screen in various picture formats: Auto / 4:3 / 16:9 / Zoom1 / Zoom2.

### Advanced Settings

- Noise Reduction: Reduces the noise level of the connected device (Medium / Strong / Off / Weak).
- Dynamic Contrast: Adjusts the dynamic contrast (Medium / Strong / Off / Weak).

4. Press the **EXIT** button to exit menu.

## Sound Management (ATV/DTV Mode)

1. Press the **MENU** button to display the main menu. Press the **◀▶** buttons to select **Sound** in the main menu, then press the **▼** or **OK** button, it will highlight the first option.
2. Press the **▲▼** buttons to select the option you want to adjust in Sound menu.
3. Press the **◀▶▲▼** buttons to change the following settings.

### TIPS:

- You can change the value of treble and bass when the sound is in Personal mode.
- You can press the **S.MODE** button on the remote control to change the Sound Mode directly.

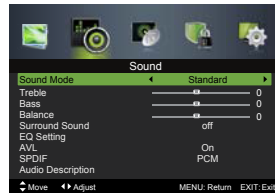

### Sound Mode:

Allows the selection of an audio-enhancement technical from among the following options: Standard, Music, Movie and Personal. You can change the value of Treble and Bass when the sound is in Personal mode.

### Treble

Controls the relative intensity of higher-pitched sounds.

### Bass

Controls the relative intensity of lower-pitched sounds.

### Balance

Adjusts the relative volume of the speakers in a multiple speaker system.

### Surround Sound

Selects to turn On/Off Surround Sound.

**Sound Management (ATV/DTV Mode)**

**EQ Setting**

Allows the selection of an equalizer mode: Off / Rock/ Pop / Jazz / User. You can change the EQ value under User mode.

**AVL**

Selects to turn On/ Off Audio Volume Leveler.

**SPDIF Mode**

Select the digital audio output mode: Auto / Off / PCM

**Audio Description**

Selects to turn On/Off Audio Description.

**Stereo / Dual Sound Reception (ATV Mode)**

When a programme is selected, press the **NICAM** button to display the sound information for the selected station.

Broadcast	On Screen Display
Mono	Mono
Stereo	STEREO
Dual	DUAL I, DUAL II, DUAL I+II

**Mono sound selection**

If the stereo signal is weak in stereo reception, you can switch to mono by pressing the **NICAM** button. In mono reception, the clarity of sound is improved. To switch back to stereo, press the **NICAM** button again.

**Language selection for dual language broadcast**

If a programme can be received in two languages (dual language), you can switch to DUAL I, DUAL II, DUAL I+II or Mono by pressing the **NICAM** button repeatedly.

DUAL I	Sends the primary broadcast language to the loudspeakers
DUAL II	Sends the secondary broadcast language to the loudspeakers
DUAL I+II	Sends the primary and secondary broadcast languages to the loudspeakers

**Channel Management (ATV / DTV Mode)**

**Auto Scan**

Use this to automatically find and store all available channels. This is normally recommended if some channels have been added or removed by the broadcaster or you have moved house.

1. Press the **MENU** button to display the main menu. Press the **◀▶** buttons to select **Channel** in the main menu, then press the **▼** or **OK** button, it will highlight the first option.

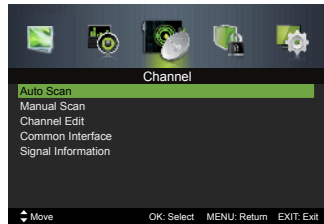

2. Press the **▲▼** buttons to select Auto Scan and then press the **OK** button to enter sub-menu.

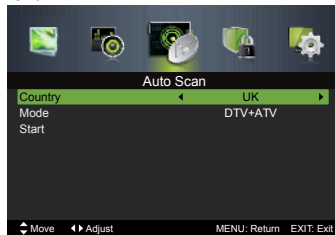

3. Press the **◀▶▲▼** buttons to navigate the menu and change the settings.

**Country**

Selects the country where you will operate the TV.

**Mode**

Selects the auto scan mode: DTV+ATV/DTV/ATV.

**Start**

Press the **OK** button to start auto tuning.

## Channel Management (ATV / DTV Mode)

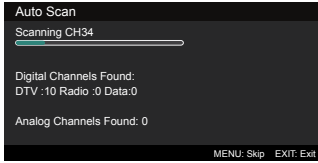

If you stop the tuning before it has finished, the TV may report a no signal error. This is normal because all previous channel memory has been cleared after tuning is carried out.

### Manual Scan (DTV Mode)

Allows you to make manual fine tuning adjustments to the channel under DTV mode.

1. Press the **MENU** button to display the main menu. Press the **◀▶** buttons to select **Channel** in the main menu, then press the **▼** or **OK** button, it will highlight the first option.

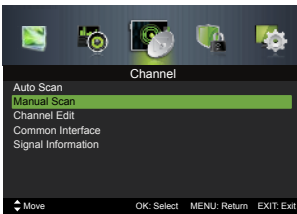

2. Press the **▲▼** buttons to select **Manual Scan** and then press the **OK** button. On the sub-menu, select Digital Manual Scan and then press the **OK** button.

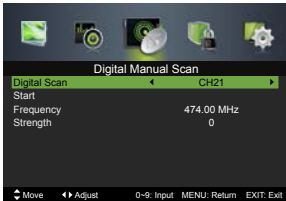

### Digital Scan

Press the **◀▶** buttons to select the desired channel.

### Start

Press the **▲▼** buttons to select Start and then press the **OK** button to start tuning.

### Manual Scan (ATV Mode)

Allows you to make manual fine tuning adjustments if the channel reception is poor under ATV mode.

1. Press the **MENU** button to display the main menu. Press the **◀▶** buttons to select **Channel** in the main menu, then press the **▼** or **OK** button, it will highlight the first option.

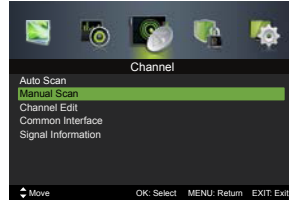

2. Press the **▲▼** buttons to select **Manual Scan** and then press the **OK** button. On the sub-menu, select Analog Manual Scan and then press the **OK** button.

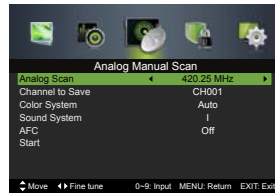

### Analog Scan

Displays the current frequency, press the **◀▶** buttons to change the frequency.

### Channel to Save

Press the **▲▼** buttons to select Channel to Save, press the **◀▶** buttons to select channel number you want to store.

### Color System

Press the **◀▶** buttons to select Color System, press the **◀▶** buttons to select: Auto / PAL.

### Sound System

Press the **▲▼** buttons to select Sound System, press the **◀▶** buttons to select: DK / BG / I / L.

### AFC

Press the **▲▼** buttons to select AFC, press the **◀▶** buttons to select On or Off.

### Start

Press the **▲▼** buttons to select Start, press the **◀▶** buttons to start tuning.

Channel Management (ATV / DTV Mode)

**Channel Edit (DTV mode)**

1. Press the **MENU** button to display the main menu. Press the **◀▶** buttons to select **Channel** in the main menu, then press the **▼** or **OK** button, it will highlight the first option.

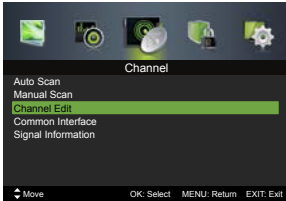

2. Press the **▲▼** buttons to select **Channel Edit** and then press the **OK** button to enter sub-menu.

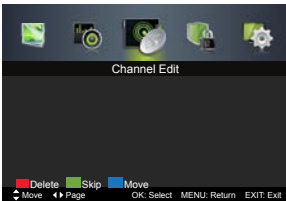

**Delete**

Press the **RED** button to delete the selected channel.

**Skip**

Press the **GREEN** button to select the channels that you want to skip when you are selecting channels. Press the **GREEN** button again to undo it.

**Move**

Press the **BLUE** button and then press the **▲▼** buttons to move to the selected channel. Press the **BLUE** or the **OK** button to confirm.

**Channel Edit (ATV mode)**

1. Press the **MENU** button to display the main menu. Press the **◀▶** buttons to select **Channel** in the main menu, then press the **▼** or **OK** button, it will highlight the first option.

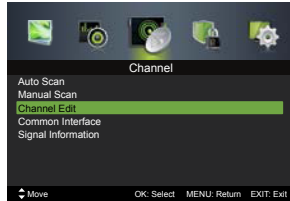

2. Press the **▲▼** buttons to select **Channel Edit** and then press the **OK** button to enter sub-menu.

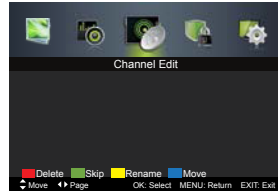

**Delete**

Press the **RED** button to delete the selected channel.

**Skip**

Press the **GREEN** button to select the channels that you want to skip when you are selecting channels. Press the **GREEN** button again to undo it.

**Rename**

Press the **YELLOW** button to rename the selected channel. Press the **▲▼** buttons to select the characters to represent the station name. Press the **◀▶** buttons to move to the next character and then press the **OK** button again to confirm the new name.

**Move**

Press the **BLUE** button and then press the **▲▼** buttons to move to the selected channel. Press the **BLUE** or the **OK** button to confirm.

**Favorite List**

Press the **FAV** button to display the Favorite List, press the **GREEN** button to set the channel that you are currently watching as one of the favorite programmes. Press the **RED** button to delete the selected channel.

## Channel Management (ATV / DTV Mode)

### Common Interface (DTV mode)

To view the module information.

1. Press the **MENU** button to display the main menu. Press the **◀▶** buttons to select **Channel** in the main menu, then press the **▼** or **OK** button.
2. Press the **▲▼** buttons to select **Common Interface** and then press the **OK** button.

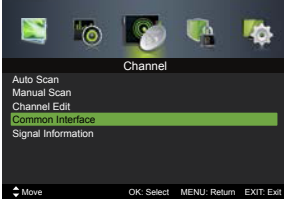

3. A Common Interface main menu will pop up. Press the **▲▼** buttons to select the items and press the **OK** button to confirm.

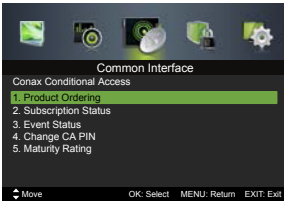

4. Press the **EXIT** button to exit the menu.

The common interface allows the use of a Common Access Module to enable you to view scrambled (pay to view) services. These services are provided by TopUp TV (UK only) and others. The Common Access Module and viewing card can be obtained from the service provider.



Do not repeatedly insert or remove the Common Access Module as this may damage the interface and cause a malfunction.

This feature is not available in all country.

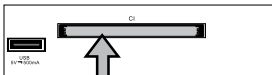

**CI (Common Interface)**  
Allows the Common Access Module to be inserted and access the content that has been encrypted.

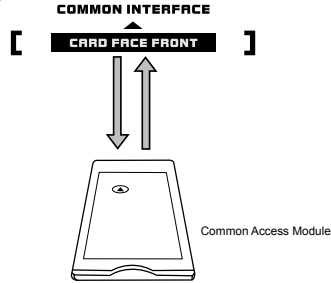

### To insert the Common Access Module

1. Before you insert the Common Access Module, ensure that the TV is switched off and the viewing card is inserted *in accordance with the Service Provider's instructions*.
2. Insert the Common Access Module into the slot. Flip the Common Access Module to another side and try again if you feel resistance.
3. Switch the TV on.

### To remove the Common Access Module

1. Before you remove the Common Access Module, ensure that the TV is switched off.
2. Pull the Common Access Module from the slot.
3. Switch the TV on.

### Signal Information (DTV mode)

1. Press the **MENU** button to display the main menu. Press the **◀▶** buttons to select **Channel** in the main menu, then press the **▼** or **OK** button.
2. Press the **▲▼** buttons to select **Signal Information** and then press the **OK** button to view the Signal Information..

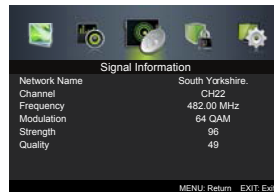

3. Press the **EXIT** button to exit the menu.

## Lock System Management

1. Press the **MENU** button to display the main menu. Press the **◀▶** buttons to select **Lock System** in the main menu, then press the **▼** or the **OK** button, it will highlight the first option.
2. Use the **0-9** buttons to input a 4-digit password to enter the Lock System menu.
3. Press the **▲▼** buttons to select the option you want to adjust in Lock System menu.
4. Press the **▲▼◀▶** buttons to change the following settings.

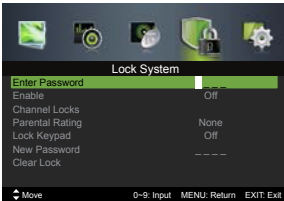

Default password "0000".

If you change the password, be sure to remember the new password! If you forget the new password, press the master password "8899".

### Enter Password

To access the Lock System menu, you must enter the password. Enter the default password "0000" for the first time use.

### Enable

The lock system is designed to prevent accidental returning of the TV/losing channels and prevent children watching unsuitable programme.

The Lock System must be set to On for this function to operate. If the Lock System is set to On, a valid password must be entered when you access Auto Scan / Manual Scan / Channel Edit /First Time Setup.

### Channel Locks

Channel Locks is designed to prevent children watching unsuitable programmes. When a channel is blocked, a valid password must be entered.

### Parental Rating

This function allows you to set up blocking schemes to block specific channels and ratings. Press the **◀▶** buttons to select an age rating: None, 4-18.

## Lock System Management

### Lock Keypad

Key Lock is designed to prevent children from pressing the buttons on the TV. The Lock System must be set On for this function to operate.

### New Password

Use the **0-9** buttons to input the new 4-digit password.

Re-enter new password for confirmation.

### Clear Lock

Reset all the lock settings except the new password to the factory defaults.

5. Press the **EXIT** button to exit the menu.

## Setup Management

### OSD Language

1. Press the **MENU** button to display the main menu. Press the **◀▶** buttons to select **Setup** in the main menu, then press the **▼** or the **OK** button, it will highlight the first option.
2. Press the **▲▼** buttons to select **OSD Language** and then press the **◀▶** buttons to select your desired on-screen display language.

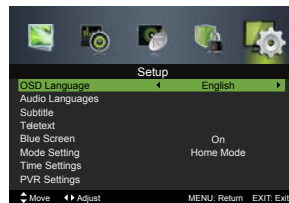

3. Press the **EXIT** button to exit the menu.



## Setup Management

### Audio Languages (DTV Mode)

1. Press the **MENU** button to display the main menu. Press the **◀▶** buttons to select **Setup** in the main menu, then press the **▼** or the **OK** button, it will highlight the first option.
2. Press the **▲▼** buttons to select **Audio Languages** and then press the **OK** button.

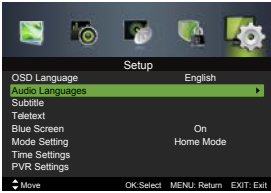

3. Press the **◀▶** buttons to select your desired Audio Primary Language. Press the **▼** button and then press the **◀▶** buttons to select your desired Audio Secondary Language.

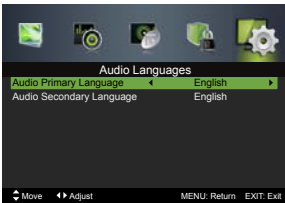

4. Press the **EXIT** button to exit the menu.

### Subtitle (DTV Mode)

1. Press the **MENU** button to display the main menu. Press the **◀▶** buttons to select **Setup** in the main menu, then press the **▼** or the **OK** button, it will highlight the first option.
2. Press the **▲▼** buttons to select **Subtitle** and then press the **OK** button to enter sub-menu.

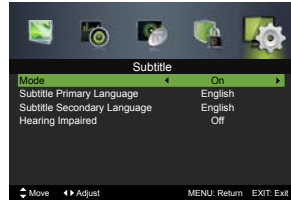
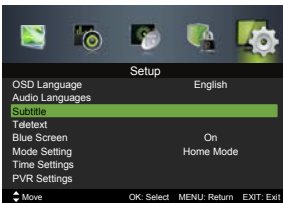

### Mode:

Selects to turn On/Off subtitle language.

### Subtitle Primary Language

Press the **◀▶** buttons to select your desired subtitle primary language.

### Subtitle Secondary Language

Press the **◀▶** buttons to select your desired subtitle secondary language.

### Hearing Impaired

Press the **◀▶** buttons to turn On/Off hearing impaired.

3. Press the **EXIT** button to exit the menu.

### Teletext

1. Press the **MENU** button to display the main menu. Press the **◀▶** buttons to select **Setup** in the main menu, then press the **▼** or the **OK** button, it will highlight the first option.
2. Press the **▲▼** buttons to select **Teletext** and then press the **OK** button.
3. Press the **◀▶** buttons to select your desired Digital Teletext Language. Press the **▼** button and then press the **◀▶** buttons to select your desired Decoding Page Language.

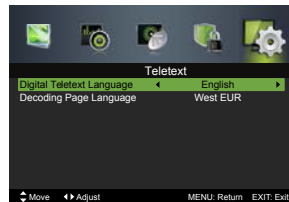

4. Press the **EXIT** button to exit the menu.

## Setup Management

### Blue Screen

1. Press the **MENU** button to display the main menu. Press the ◀▶ buttons to select **Setup** in the main menu, then press the ▼ or the **OK** button, it will highlight the first option.
2. Press the ▲▼ buttons to select **Blue Screen** and then press the ◀▶ buttons to select On /Off.

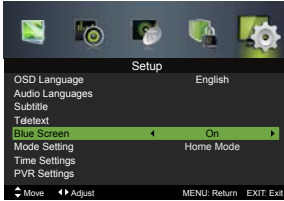

3. Press the **EXIT** button to exit the menu.

### Mode Setting

1. Press the **MENU** button to display the main menu. Press the ◀▶ buttons to select **Setup** in the main menu, then press the ▼ or the **OK** button, it will highlight the first option.
2. Press the ▲▼ buttons to select **Mode Setting** and then press the ◀▶ buttons to select your desired mode: Home Mode/Store Mode.
  - Home Mode: Viewing at home.
  - Store Mode: For store demo, the brightness is higher than home mode.

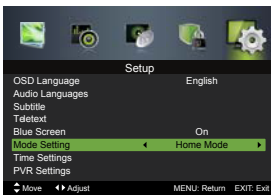

3. Press the **EXIT** button to exit the menu.

### Time Settings

1. Press the **MENU** button to display the main menu. Press the ◀▶ buttons to select **Setup** in the main menu, then press the ▼ or the **OK** button, it will highlight the first option.
2. Press the ▲▼ buttons to select **Time Settings** and then press the **OK** button.

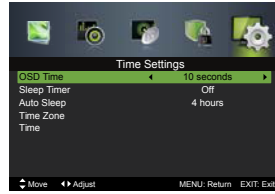

### OSD Time

Displays time of the on-screen menu: 10s/20s/30s/60s/Off.

### Sleep Timer

Press the ◀▶ buttons to select a period of time after which the TV automatically switches to standby mode: Off/5/15/.../120/240mins.

### Auto Sleep

The unit will automatically switch to standby mode 3/4/5 hours after the last time the remote control was used. If you want to operate the TV for a long period of time, turn off the auto standby function.

### Time Zone

Selects your desired Time Zone city.



## Setup Management

### Time

The clock is set automatically when receiving a digital signal or you can set it manually.

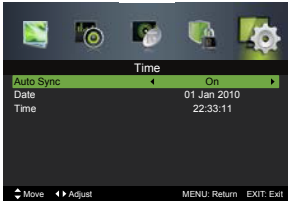

3. Press the **EXIT** button to exit the menu.

### PVR Settings

**NOTE:** Please make sure the USB device is inserted. If not, a warning message will pop up.

1. Press the **MENU** button to display the main menu. Press the **◀▶** buttons to select **Setup** in the main menu, then press the **▼** or the **OK** button, it will highlight the first option.
2. Press the **▲▼** buttons to select **PVR Settings** and then press the **OK** button.

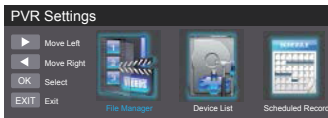

3. Press the **◀▶** buttons to select the following PVR File System options and then press the **OK** button.

### File Manager

Select File Manager to display the recorded programme list, press the **▲▼** buttons to select the recorded programme and then press the **OK** or **▶||** button to view.

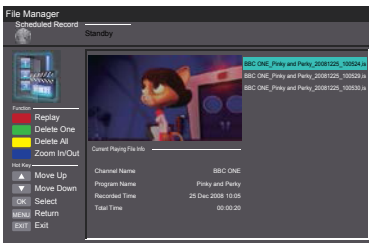

### Device List

Select Device List to check the information of the connected USB storage device for PVR. Press the **RED** button to format the selected USB device.

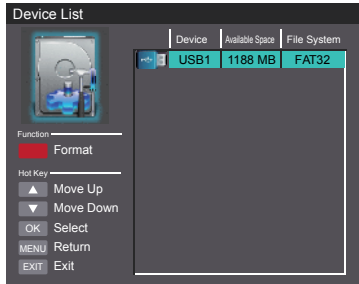

### Scheduled Record

Select Scheduled Record to view the scheduled recordings list.

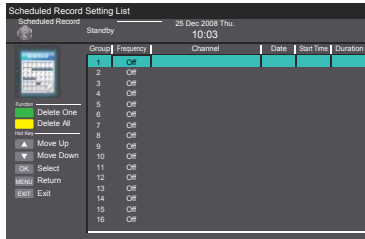

4. Press the **EXIT** button to exit the menu.

Setup Management

First Time Setup

1. Press the **MENU** button to display the main menu. Press the **◀▶** buttons to select **Setup** in the main menu, then press the **▼** or the **OK** button, it will highlight the first option.
2. Press the **▲▼** buttons to select **First Time Setup** and then press the **OK** button.

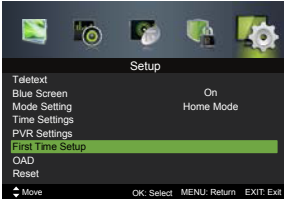

3. Press the **▲▼◀▶** buttons to navigate the menu and change the settings. Then it will search automatically for analogue and digital TV programmes.
4. Press the **EXIT** button to exit the menu.

OAD (Over Air Download)

1. Press the **MENU** button to display the main menu. Press the **◀▶** buttons to select **Setup** in the main menu, then press the **▼** or the **OK** button, it will highlight the first option.
2. Press the **▲▼** buttons to select **OAD** and then press the **OK** button.

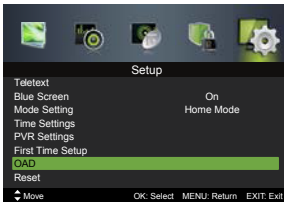

3. Press the **▲▼** buttons to select the over air download type.

Manual OAD Download

The TV auto detects the latest firmware through the DTV signal and allows you to accept or refuse the firmware upgrade service.

Auto Download

The TV auto detects the latest firmware through the DTV signal and upgrades the firmware automatically. Selects to turn On/Off auto OAD download.

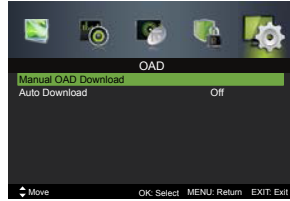

4. Press the **EXIT** button to exit the menu.

Reset

1. Press the **MENU** button to display the main menu. Press the **◀▶** buttons to select **Setup** in the main menu, then press the **▼** or the **OK** button, it will highlight the first option.
2. Press the **▲▼** buttons to select **Reset** and then press the **OK** button.



3. Press the **◀▶** buttons to select Yes or No on the screen. All settings except the lock settings will be reset to factory defaults and the Setup menu will disappear.

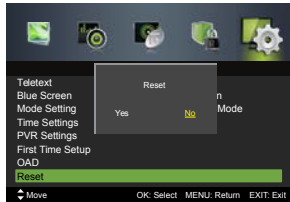

## Entertainment

### Using the Features via USB Port

1. Switch off the TV before connecting any USB storage device.
2. Connect your USB storage device to the USB port of your TV.
3. Press the **⓪** button on the bottom of the TV or the **⓪** button on the remote control to turn on your TV and your USB storage device.
4. Press the **SOURCE** button on the bottom of the TV or the **SOURCE** button on the remote control to display the Source List. Use the **▲** **▼** buttons to select USB and then press the **OK** button to confirm.

### Attention:

- Some versions of portable hard disk may require more power than the TV USB socket can provide. To ensure correct operation please use power adapter for that device.
- If a USB hub is used make sure its mains adapter is connected to the mains supply as the total current consumption exceed 500mA.
- The maximum supported storage space of the hard disk is 1 TB.
- The file system only support FAT32 format.
- If you want to store the video streaming of a DTV programme, the transfer rate of the USB storage device must not be less than 5MB/s, otherwise the picture and sound of the programme will be affected and a warning statement will be shown on the screen. If this happens, please upgrade your USB storage device.
- The TV screen will be blank temporarily as it will take time to start up and stabilize the connected hard disk. This is normal and the starting time may vary depending on the brand and the memory size of the connected hard disk.
- Disconnect the USB storage device if it is not in use.

### Viewing Photo

1. Press the **SOURCE** button on the bottom of the TV or the **SOURCE** button on the remote control then press the **▲▼** buttons to select the USB mode and then press the **OK** button.
2. Press the **◀▶** buttons to select **Photo** and then press the **OK** button.

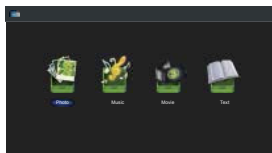

3. Press the **◀▶** buttons to select your storage device and then press the **OK** button.

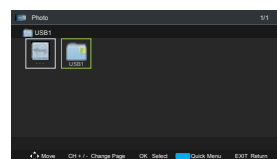

4. Press the **▲▼▶◀** buttons to navigate in the picture folder and then press the **OK** button. If you want to select the specified photos, press the **▲▼▶◀** buttons to select the picture file and then press the **OK** button.

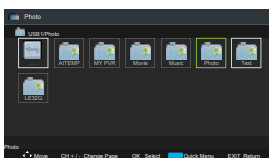

5. Press the **▶▶** or **OK** button to view.



Entertainment

6. Press the **OK** button or the **DISPLAY** button to display the function bar: Play / Pause / Previous / Next / Rotate / Quick Menu (Interval Time / Repeat / Slideshow Effect / Background Music).

 If this folder also contains music files, you can select a music track to play at the same time you view your photos.

7. Press the **EXIT** button to return to the previous menu.

**Listening to Music**

1. Press the **SOURCE** button on the bottom of the TV or the **SOURCE** button on the remote control then press the **▲▼** buttons to select the USB mode and then press the **OK** button.
2. Press the **◀▶** buttons to select **Music** and then press the **OK** button.

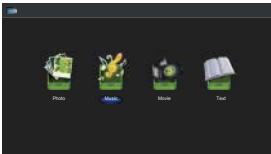

3. Press the **▲▼** buttons to select your storage device and then press the **OK** button.

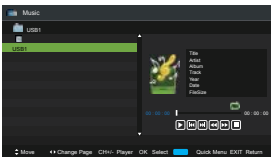

4. Press the **▲▼** buttons to navigate in the music folder and then press the **OK** button. If you want to select the specified music, press the **▲▼** buttons to select the music file and then press the **OK** button.

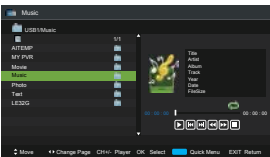

 Some audio file formats will not be supported. Supported File format: MP3.

5. Press the **▶||** or **OK** button to start to play.

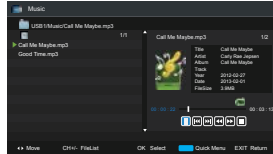

6. Press the **◀▶** buttons and then press the **OK** button to select the function: Play / Previous / Next / FB / FF / Stop / Quick Menu (Repeat).
7. Press the **EXIT** button to return to the previous menu.

**Viewing Movies**

1. Press the **SOURCE** button on the bottom of the TV or the **SOURCE** button on the remote control then press the **▲▼** buttons to select the USB mode and then press the **OK** button.
2. Press the **◀▶** buttons to select **Movie** and then press the **OK** button.

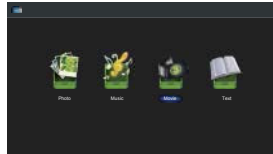

3. Press the **▲▼** buttons to select your storage device and then press the **OK** button.

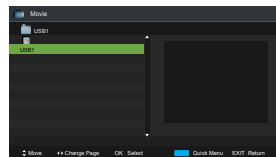

4. Press the **▲▼** buttons to navigate in the movie folder and then press the **OK** button. If you want to select the specified movie, press the **▲▼** buttons to select the movie file and then press the **OK** button.

 Some audio file formats will not be supported. Supported File format: MPEG 1/2.

Entertainment

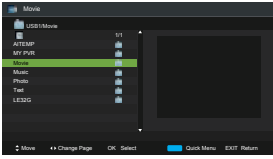

5. Press the **▶||** or **OK** button to view.

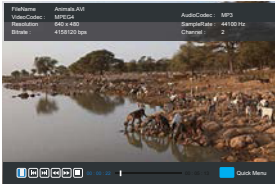

6. Press the **OK** button or the **DISPLAY** button to display the function bar. Press the **◀▶** buttons and then press the **OK** button to select the function: Pause / Previous / Next / FB / FF / Stop / Quick Menu (Repeat / Encode Type).

7. Press the **EXIT** button to return to the previous menu.

**My Text**

1. Press the **SOURCE** button on the bottom of the TV or the **SOURCE** button on the remote control then press the **▲▼** buttons to select the USB mode and then press the **OK** button.
2. Press the **◀▶** buttons to select **Text** and then press the **OK** button.

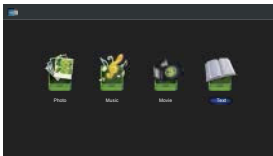

3. Press the **▲▼** buttons to select your storage device and then press the **OK** button.

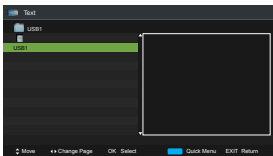

4. Press the **▲▼** buttons to navigate in the text folder and then press the **OK** button. If you want to select the specified text file, press the **▲▼** buttons to select the text file and then press the **OK** button.

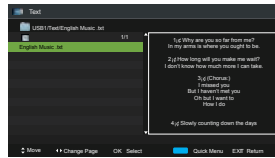
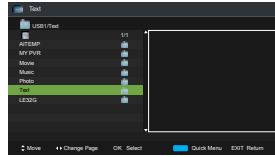

5. Press the **▶||** or **OK** button to view.

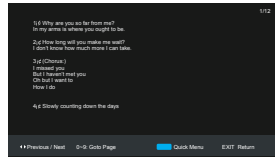

6. Press the **OK** button or the **DISPLAY** button to display the function bar. Press the **◀▶** buttons and then press the **OK** button to select the function: Previous / Next / Goto Page / Quick Menu (Repeat / Background Music / Encode Type).

**!** If this folder also contains music files, you can select a music track to play at the same time you view your texts.

7. Press the **EXIT** button to return to the previous menu.

## PARENTAL CONTROL

Press the **MENU** button on the main unit or on the remote control and then press ◀/▶ buttons to select **LOCK** menu. Use the **0-9** buttons to input the 4-digit password to enter the **LOCK** menu. If used, this option feature can “block” undesirable programming from appearing on the TV.

Parental Control offers the user a wide variety of options and settings that restrict or “block” the programming that can appear on the TV. Parental Control allows the user to define which program rating they consider acceptable for the younger more sensitive viewer. It can be preset and turned either on or off by the user who specifies the secret 4-number password. General audiences and children blocks should be both programmed into the TV's memory. Separate different viewer ratings are specified for both TV and the motion picture industry; both rating systems should be used and based on the ages of children.

### **Key Lock:**

If the key lock is set On, all buttons on the TV will be locked. All TV operations can be controlled by the remote control only. Press the ◀/▶ buttons to select On or Off.

### **Notice:**

The default password is “0000”. If you change the password, be sure to remember the new password! If you forget your password, press the master password “8899” on the remote control.



## DIGITAL RECEPTION

MHEG-5 ENGINE compliant with ISO/IEC 13522-5 UK engine Profile 1 - for UK
Object carousel support compliant with ISO/IEC 135818-6 and UK DTT profile - for UK
Frequency range: 474-850 MHz for UK models
170-862 MHz for EU models
Transmission standard: DVB-T. MPEG-2
Demodulation: COFDM with 2K/8K FFT mode
FEC: all DVB modes
Video: MP@ML, PAL, 4:3/16:9
Audio: MPEG Layer I&II 32/44.148kHz.

We apologise for any inconvenience caused by any minor inconsistencies in these instructions, which may occur as a result of product improvements and development.

## SUPPORTED FILE FORMATS

Media	File Extension	Format		Supported (Maximum resolution/Bit rate etc.)
		Video	Audio	
Movie	.mpg/.dat/.vob	MPEG-1	MPEG-1 Layer 2/3	
		MPEG-2	MPEG-2 Layer3	
Music	.mp3	-	MPEG-1 Layer3 MPEG-2 Layer3	Bit Rate: up to 320Kbps Sample Rate: 32KHz, 44.1KHz, 48KHz
Photo	.jpg	Baseline Mode		72x72<Baseline resolution<7680x4320 Progressive Mode Size<=1280x1024 File Size<=10MB
		Progressive Mode		

## TROUBLESHOOTING

If your TV does not operate normally or cannot be turned on, please check the following troubleshooting questions. Remember also to check any other connected electronic device, such as DVD or Blu-ray player to pinpoint the problem. If the TV still fails to operate normally, please contact technical support.

### The TV does not operate properly

The TV does not respond when pressing any buttons	<ul style="list-style-type: none"> <li>The TV may freeze up during use. Disconnect the power cord from the power socket for a few minutes. Reconnect the power cord and try to operate it again as usual.</li> </ul>
TV cannot be switched on	<ul style="list-style-type: none"> <li>Check that the TV is connected to the power supply.</li> <li>Make sure all connected AV devices are switched off before switching on your TV.</li> </ul>
The remote control does not work	<ul style="list-style-type: none"> <li>Check to see if there are any objects between the TV and the remote control causing an obstruction. Ensure that you are pointing the remote control directly at the TV.</li> <li>Ensure that the batteries are installed with the correct polarity (+ to +, - to -).</li> <li>Install new batteries.</li> </ul>
Power is suddenly turned off	<ul style="list-style-type: none"> <li>Check the power of the TV. The power supply maybe interrupted.</li> <li>Check if the sleep timer is set.</li> <li>Check whether the Auto Standby is activated.</li> </ul>

### The video function does not work

No picture & No Sound	<ul style="list-style-type: none"> <li>Check whether the TV is switched on.</li> <li>Try another channel. The problem may be caused by the broadcaster.</li> </ul>
Picture appears slowly after switching on	<ul style="list-style-type: none"> <li>This is normal; the image is muted during the TV startup process. Please contact your service centre if the picture has not appeared after five minutes.</li> </ul>
No or poor color or poor picture	<ul style="list-style-type: none"> <li>Adjust the settings in the PICTURE menu.</li> <li>Try another channel. The problem may be caused by the broadcaster.</li> <li>Check if video cables are connected properly.</li> </ul>
Horizontal/Vertical bar or picture shaking	<ul style="list-style-type: none"> <li>Check for local interference such as an electrical appliance or power tool.</li> </ul>
Poor reception on some channels	<ul style="list-style-type: none"> <li>The station or cable channel may be experiencing problems; tune to another station.</li> <li>Station signal may be weak, reposition the antenna for better reception.</li> <li>Check for sources of possible interference.</li> </ul>
Lines or streaks in pictures	<ul style="list-style-type: none"> <li>Check antenna (change the position of the antenna.)</li> </ul>
No pictures when connecting HDMI	<ul style="list-style-type: none"> <li>Check if the input source is HDMI1/HDMI2/HDMI3.</li> </ul>
Pictures appear in wrong ratio	<ul style="list-style-type: none"> <li>Adjust the Aspect Ratio settings in the PICTURE menu or press the ASPECT button on the remote control.</li> </ul>

**The audio function does not work**

Picture OK but no sound	<ul style="list-style-type: none"> <li>• Press the VOL +/- buttons.</li> <li>• Sound muted? Press the MUTE button.</li> <li>• Try another channel. The problem may be caused by the broadcaster.</li> </ul>
No output from one of the speakers	<ul style="list-style-type: none"> <li>• Adjust the Balance settings in the SOUND menu.</li> </ul>
Unusual sound from inside the TV	<ul style="list-style-type: none"> <li>• A change in ambient humidity or temperature may result in an unusual noise when the TV is switched on or off and does not indicate a fault with the TV.</li> </ul>
No sound when connecting HDMI	<ul style="list-style-type: none"> <li>• Check if the input source is HDMI1/HDMI2/HDMI3.</li> </ul>
Audio noise	<ul style="list-style-type: none"> <li>• Keep the RF coaxial cable away from the other connected cables.</li> </ul>

**Password**

Lost password	<ul style="list-style-type: none"> <li>• Select the Enter Password in the LOCK System menu, then enter the following master password"8899". Then you can set a new password though the New Password option.</li> </ul>
---------------	--

**There is a problem in PC mode**

The signal is out of range (invalid format)	<ul style="list-style-type: none"> <li>• Adjust the resolution, horizontal frequency, or vertical frequency.</li> </ul>
Vertical bar or stripe on background and Horizontal Noise and Incorrect position	<ul style="list-style-type: none"> <li>• Use Auto configures or adjust clock, phase, or H/V position.</li> </ul>
Screen color is unstable or show a single color	<ul style="list-style-type: none"> <li>• Check the signal cable.</li> <li>• Reinstall the PC video card.</li> </ul>

**Plug replacement - UK and Ireland only**

Should you need to replace the plug; the wires in the power cable are coloured in the following way:

Blue – Neutral 'N'

Brown – Live 'L'

As the colours of the wires in the power cable may not correspond with the coloured markings identifying the terminals in your plug, and proceed as follows:

The blue wire must be connected to the terminal that is marked with the letter N.

The brown wire must be connected to the terminal that is marked with the letter L.

If the power lead is damaged, it must be replaced by a qualified electrician.

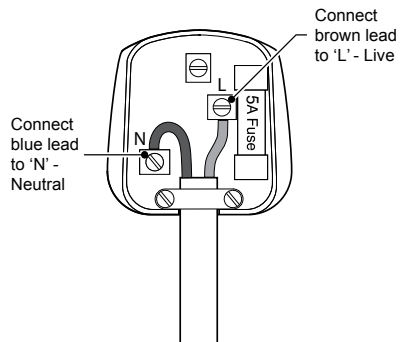

## SPECIFICATION

Panel Size	31.5 inch diagonally
Display Type	DLED
Panel Technology	TFT
Panel 60 Hz Vs. 120 Hz	60 Hz
Display Resolution	720P
Panel Resolution	1366 x 768
Aspect Ratio	16:9
Dynamic Contrast Ratio-Panel	3750~5000:1
Brightness (Centre Typ.) Cd/M <sup>2</sup>	200~250
Response Time (G To G)	7ms
Lamp Life (Typ. Hours)	30,000 hours
Horizontal Viewing Angle (At CR>10)	176
Vertical Viewing Angle (At CR>10)	176
Wall-mount(LxW-mm)	200*200(mm)

## DISPOSAL INFORMATION

### Instructions for waste disposal:

Packaging and packaging aids are recyclable and should principally be recycled. Packaging materials, such as foil bag, must be kept away from children.

The cold cathode fluorescent lamp in LCD PANEL contains a small amount of mercury; please follow the local laws or regulations for disposal.

### Information for Users on Disposal of old Equipment and Batteries (European Union only)

These symbols indicate that equipment with these symbols should not be disposed of as general household waste. If you want to dispose of the product or battery, please consider the collection systems or facilities for appropriate recycling.

**Notice:** The sign Pb below the symbol for batteries indicates that this battery contains lead.



Products



Battery

### Information for Users in European Union Countries

This symbol on the product or on its packaging means that your electrical and electronic device should be disposed of at the end of its service life separately from your household wastes. There are separate collection systems for recycling in EU.

For more information, please contact the local authority or the dealer where you purchased the product.



## SEIKI LED TV's LIMITED WARRANTY TO ORIGINAL CONSUMER

### 32 inches and Above Screen Size Models (the "Product")

This Product (including any accessories included in the original packaging) as supplied and distributed in new condition, is warranted by **SEIKI DIGITAL INC.** (SEIKI) to the original consumer purchaser against defects in material and workmanship ("Warranty") as follows:

**SHIPPING COSTS:** Notwithstanding the foregoing, the original consumer is responsible for any shipping charges incurred to ship the Product or part(s) to SEIKI or to an SEIKI authorized customer service provider, for diagnosis, repair or replacement. The consumer is responsible for securely packing the Product and utilizing a reliable carrier to transport to SEIKI authorized service provider.

**To obtain Warranty Service and Troubleshooting information call our toll free customer service line at:**

**0-845-658-8290**

**Please have your model and serial number available along with your date of purchase.**

**You can also visit us online and REGISTER your SEIKI product at:**

**[www.SEIKI.com](http://www.SEIKI.com)**

To receive Warranty service, the original consumer purchaser must contact SEIKI for problem determination and service procedures. **Proof of purchase in the form of a bill of sale or receipted invoice, evidencing that the Product is within the applicable Warranty period(s), MUST be presented to SEIKI, or an authorized customer service provider, in order to obtain the requested service.**

#### **Exclusions and Limitations**

This Warranty covers manufacturing defects in materials and workmanship encountered in the normal, non-commercial use of the Product, and does not cover (a) damage or failure caused by or attributable to abuse, misuse, failure to follow instructions, improper installation or maintenance, alteration, accident, or excess voltage or current; (b) improper or incorrectly performed repairs by non-authorized service facilities; (c) onsite consumer instruction or adjustments; (d) transportation, shipping, delivery, insurance, installation or set-up costs; (e) costs of product removal, transportation or reinstallation costs; (f) ordinary wear and tear, cosmetic damage or damage due to acts of nature, accident; (g) commercial use of the Product; (h) modification of, or to any part of the Product. In addition, this Warranty does not cover images "burnt" into the screen. This Warranty applies to the original consumer only and does not cover products sold AS IS or WITH ALL FAULTS, or consumables (e.g., fuses, batteries, bulbs etc.), and the Warranty is invalid if the factory-applied serial number has been altered or removed from the Product. This Warranty is valid only in the United States and Canada, and only applies to products purchased and serviced in the United States and Canada. All replaced parts and products, and products on which a refund is made, become the property of the Warrantor.

**NO WARRANTIES, WHETHER EXPRESS OR IMPLIED, INCLUDING, BUT NOT LIMITED TO, ANY IMPLIED WARRANTIES OF MERCHANTABILITY OR FITNESS FOR A PARTICULAR PURPOSE, OTHER THAN THOSE EXPRESSLY DESCRIBED ABOVE SHALL APPLY. THE WARRANTOR FURTHER DISCLAIMS ALL WARRANTIES AFTER THE EXPRESS WARRANTY PERIOD STATED ABOVE. NO OTHER EXPRESS WARRANTY OR GUARANTY GIVEN BY ANY PERSON, FIRM OR ENTITY WITH RESPECT TO THE PRODUCT SHALL BE BINDING ON THE WARRANTOR. REPAIR, REPLACEMENT, OR REFUND OF THE ORIGINAL PURCHASE PRICE - AT THE WARRANTOR'S SOLE DISCRETION - ARE THE EXCLUSIVE REMEDIES OF THE CONSUMER. THE WARRANTOR SHALL NOT BE LIABLE FOR ANY INCIDENTAL OR CONSEQUENTIAL DAMAGES CAUSED BY THE USE, MISUSE OR INABILITY TO USE THE PRODUCT. NOTWITHSTANDING THE FOREGOING, CONSUMER'S RECOVERY SHALL NOT EXCEED THE PURCHASE PRICE OF THE PRODUCT SOLD BY SEIKI. THIS WARRANTY SHALL NOT EXTEND TO ANYONE OTHER THAN THE ORIGINAL CONSUMER WHO PURCHASED THE PRODUCT AND IS NOT TRANSFERABLE.**

Some states do not allow the exclusion or limitation of incidental or consequential damages, or allow limitations on warranties, so the above limitations or exclusions may not apply to you. This Warranty gives you specific rights, and you may have other rights, which vary from state to state.

**PLEASE CONTACT CUSTOMER SERVICE TO OBTAIN SHIPPING ADDRESSES FOR SERVICE.**

Service Hotline:  
**0-845-658-8290**

[www.SEIKI.com](http://www.SEIKI.com)

IMPORTER ADDRESS:

**TONGFANG GLOBAL (UK) CO. LIMITED**  
RADNOR HOUSE GREENWOOD CLOSE  
CARDIFF GATE BUSINESS PARK  
CARDIFF  
UNITED KINGDOM  
CF23 8AA  
**Company No. 07230773**