

# CONTENTS

<b>Important Safety Instructions</b>	<b>2</b>
<b>Safety Information</b>	<b>3</b>
<b>Preparation</b>	<b>4</b>
What's Included	4
Front View	5
Rear View	6
Installing the Stand	7
Removing the Stand for Wall-Mounting	7
Remote Control	8
<b>Connecting External Devices</b>	<b>10</b>
<b>Customizing TV Settings</b>	<b>11</b>
Initial Setup	11
Navigating the Setup Settings	13
Streaming	13
Media	14
Viewing Photos	15
Listening to Music	15
Viewing Movies	16
My Text	17
Source	17
Setup	18
Settings	18
Audio	19
Picture	20
Channel	21
Time	25
Network	26
Lock	28
<b>Using the Features</b>	<b>29</b>
<b>Parental Control</b>	<b>35</b>
<b>Troubleshooting</b>	<b>36</b>
<b>Maintaining</b>	<b>37</b>
<b>Specification</b>	<b>38</b>
<b>Disposal Information</b>	<b>38</b>
<b>Limited Warranty</b>	<b>39</b>
<b>OTT APP Service</b>	<b>40</b>

## IMPORTANT SAFETY INSTRUCTIONS

- **Read these instructions** – All the safety and operating instructions should be read before this product is operated.
- **Keep these instructions** – The safety and operating instructions should be retained for future reference.
- **Heed all warnings** – All warnings on the appliance and in the operating instructions should be adhered to.
- **Follow all instructions** – All operating and use instructions should be followed.
- **Do not use this apparatus near water** – The appliance should not be used near water or moisture – for example, in a wet basement or near a swimming pool, and the like.
- Clean only with dry cloth.
- Do not block any ventilation openings. Install in accordance with the manufacture's instructions.
- Do not install near any heat sources such as radiators, heat registers, stoves, or other apparatus (including amplifiers) that produce heat.
- Do not defeat the safety purpose of the polarized or grounding-type plug. A polarized plug has two blades with one wider than the other. A grounding-type plug has two blades and a third grounding prong. The wide blade or the third prong are provided for your safety. If the provided plug does not fit into your outlet, consult an electrician for replacement of the obsolete outlet.
- Protect the power cord from being walked on or pinched particularly at plugs, convenience receptacles, and the point where they exit from the apparatus.
- Only use attachments/accessories specified by the manufacturer.
- Use only with the cart, stand, tripod, bracket, or table specified by the manufacturer, or sold with the apparatus. When a cart is used, use caution when moving the cart/apparatus combination to avoid injury from tip-over.
- Unplug this apparatus during lightning storms or when unused for long periods of time.
- Refer all servicing to qualified service personnel. Servicing is required when the apparatus has been damaged in any way, such as power-supply cord or plug is damaged, liquid has been spilled or objects have fallen into the apparatus, the apparatus has been exposed to rain or moisture, does not operate normally, or has been dropped.
- Please keep the unit in a well-ventilated environment.
- **WARNING:** To reduce the risk of fire or electric shock, do not expose this apparatus to rain or moisture. The apparatus shall not be exposed to dripping or splashing. Objects filled with liquids, such as vases should not be placed on apparatus.
- **WARNING:** The batteries shall not be exposed to excessive heat such as sunshine, fire or the like.
- **WARNING:** The mains plug is used as disconnect device, the disconnect device shall remain readily operable.
- **WARNING:** To reduce the risk of electric shock, do not remove cover (or back) as there are no user-serviceable parts inside. Refer servicing to qualified personnel.



This lightning flash with arrowhead symbol within an equilateral triangle is intended to alert the user to the presence of non-insulated "dangerous voltage" within the product's enclosure that may be of sufficient magnitude to constitute a risk of electric shock.



The exclamation point within an equilateral triangle is intended to alert the user to the presence of important operating and maintenance instructions in the literature accompanying the appliance.



This equipment is a Class II or double insulated electrical appliance. It has been designed in such a way that it does not require a safety connection to electrical earth.



**Warning:** To prevent the spread of fire, keep candles or other open flames away from this product at all times.

## SAFETY INFORMATION



This product contains electrical or electronic materials. The presence of these materials may, if not disposed of properly, have potential adverse effects on the environment and human health.

Presence of this label on the product means it should not be disposed of as unsorted waste and must be collected separately. As a consumer, you are responsible for ensuring that this product is disposed of properly.

**WARNING:** To prevent injury, this apparatus must be securely attached to the floor/wall in accordance with the installation instruction.

To ensure reliable and safe operation of this equipment, please carefully read all the instructions in this user guide, especially the safety information below.

### Electrical Safety

- The TV set should only be connected to a main power supply with voltage that matches the label at the rear of the product.
- To prevent overload, do not share the same power supply socket with too many other electronic components.
- Do not place any connecting wires where they may be stepped on or tripped over.
- Do not place heavy items on any connecting wire, which may damage the wire.
- Hold the main plug, not the wires, when removing from a socket.
- During a thunderstorm, or when not using the television for extended period of time, turn off the power switch on the back of the television.
- Do not allow water or moisture to enter the TV or power adapter. Do NOT use in wet, moist areas, such as bathrooms, steamy kitchens or near swimming pools.
- Pull the plug out immediately, and seek professional help if the main plug or cable is damaged, liquid is spilled onto the set, if the TV set accidentally exposed to water or moisture, if anything accidentally penetrates the ventilation slots or if the TV set does not work normally.
- Do not remove the safety covers. There are no user-serviceable parts inside. Trying to service the unit yourself is dangerous and may invalidate the product's warranty. Qualified personnel must only service this apparatus.
- To avoid a battery leakage, remove batteries from the remote control, when the remote is not use for long period, or when the batteries are exhausted.
- Do not break open or throw exhausted batteries into a fire.

### Physical Safety

- Do not block ventilation slots in the back cover. You may place the TV in a cabinet, but ensure at least 5cm (2") clearance all around.
- Do not tap or shake the TV screen, or you may damage the internal circuits. Take good care of the remote control.
- To clean the TV use a soft dry cloth. Do not use solvents or petroleum based fluids.
- Do not install near any heat sources such as radiators, heat registers, stoves or other apparatus (including amplifiers) that produce heat.
- Do not defeat the safety purpose of the polarized or grounding-type plug. A polarized plug has two blades with one wider than the other. A grounding plug has two blades and a third grounding prong. The wide blade, or the third prong is provided for your safety. If the provided plug does not fit into your outlet, consult an electrician for replacement of the obsolete outlet.
- Protect the power cord from being walked on or pinched particularly at plugs.
- Unplug the apparatus during lightning storms or when unused for long periods.
- Refer all servicing to a qualified service personnel. Servicing is required if the apparatus does not operate normally or if the apparatus, including the power supply cord or plug, has been damaged in any way.
- Servicing is also required if liquid has been spilled, or objects have fallen into the apparatus; when the apparatus has been exposed to rain or moisture; or if the apparatus has been dropped.
- Always connect your television to a power outlet with protective ground connection.

# PREPARATION

## What's Included

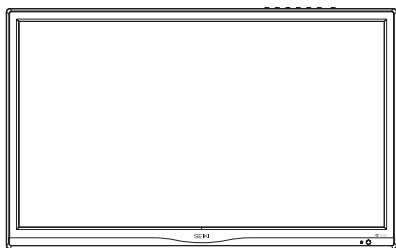

TV Set

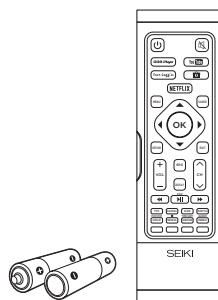

Remote Control with Batteries



Base Stand

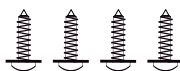

Screws x4

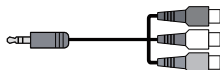

MINI AV cable

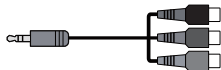

MINI YPBPR cable

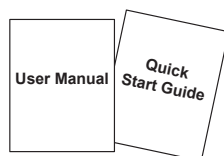

User Manual &  
Quick Start Guide

## Front View

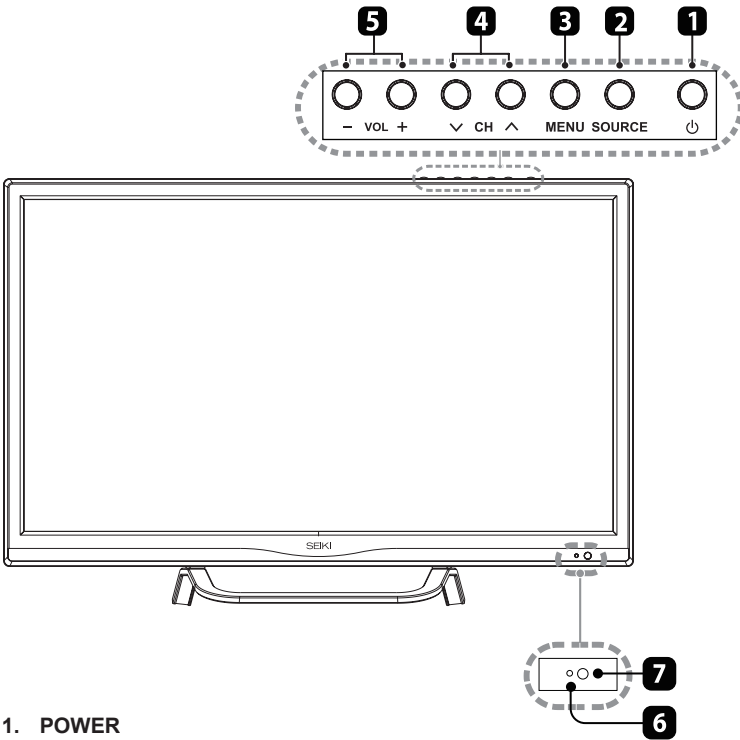

- 1. POWER**  
Switch the TV between On / Standby mode.
- 2. SOURCE**  
Press to select among different input signal sources.
- 3. MENU**  
Display the main menu.
- 4. CH ^/∨**  
Press to select a channel.
- 5. VOL +/-**  
Press to adjust the volume.
- 6. POWER Indicator**  
Illuminate blue when the TV is turned on. Illuminate red when the TV is in standby mode.
- 7. IR (Infrared Receiver)**  
Receive IR signals from the remote control.

## Rear View

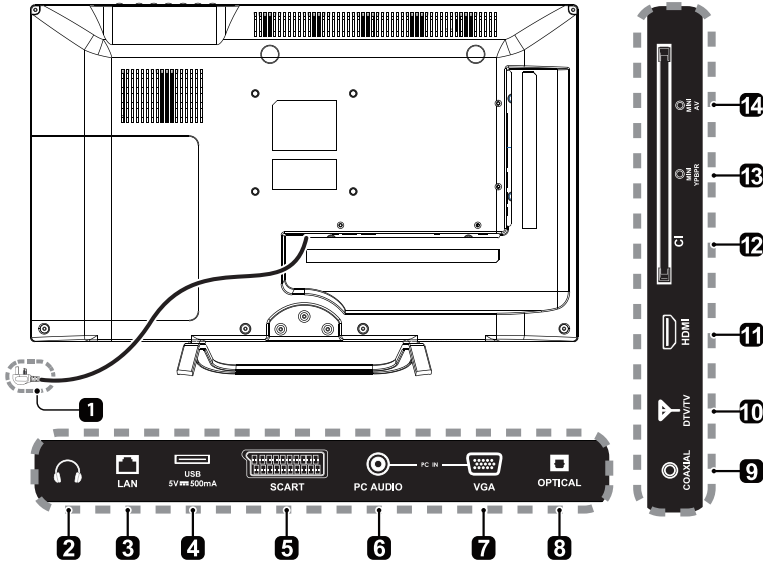

- 1. Power Cord**  
Connect to AC power outlet.
- 2. Headphone Socket**  
Connect to the composite VIDEO and AUDIO (L/R) output sockets on external video devices.
- 3. LAN**  
Network connection port.
- 4. USB Port**  
Connect to a USB storage device to play compatible video, audio, photo and text files. (USB mode)
- 5. SCART Socket**  
Connect to SCART cable between the SCART socket on the TV and the SCART socket on the external device (decoder, or DVD player).
- 6. PC AUDIO Input**  
Connect to a computer audio output.
- 7. VGA Input**  
Connect to a computer or other devices with a VGA interface.
- 8. OPTICAL**  
Connect a digital sound system to this jack.
- 9. COAXIAL Digital Audio Output**  
Connect to the audio socket on the digital audio system.
- 10. DTV/TV Input**  
Connect to the antenna (75Ω VHF/UHF) socket with the RF coaxial cable.
- 11. HDMI Input**  
Connect to a High-Definition (HD) signal output device.
- 12. CI Slot**  
Used to insert a CI card. A CI card allows you to view all the channels that you subscribe to.
- 13. MINI YPBPR**  
Connect to AV devices with component (Y/Pb/Pr) video and audio output sockets. COMPONENT&VIDEO share with AUDIO IN(L/R)subscribe to.
- 14. MINI AV**  
Connect to the composite VIDEO and AUDIO (L/R) output sockets on external video devices.

---

## Installing the Stand

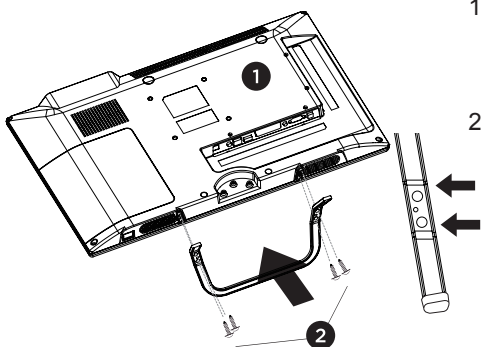

1. Lay the TV face down on a flat, cushioned surface to avoid damaging or scratching.
2. Fix the base to the TV using the 4 pcs provided screws. The 4 screws should be fixed into the holes directed by the arrow in the figure.

## Removing the Stand for Wall-Mounting

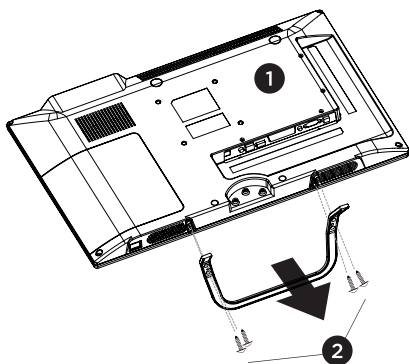

1. Lay the TV face down on a flat, cushioned surface to avoid damaging or scratching.
2. Untighten the 4 pcs screws holding the base assembly and remove them.
3. Attach the VESA wall-mount bracket to the TV using the mounting holes on the back of the TV. Mount this TV according to the instructions included in the VESA wall-mount bracket.

## Remote Control

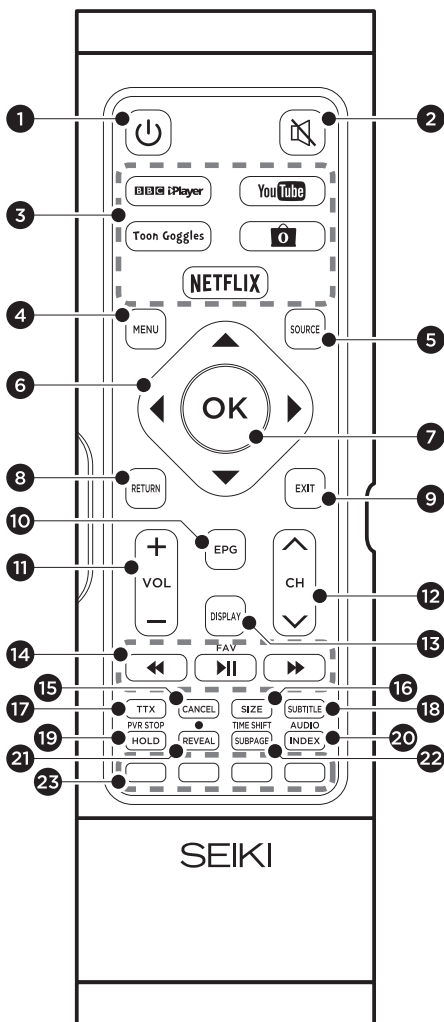

1. Switches the TV between on and standby mode.
2. Mute and restore sound.
3. Press to view the desired APP.
4. Display the main menu.
5. Select input source.
6. Navigate on screen display menu.
7. Confirm the selection.
8. Return to previous menu.
9. Exit the main menu.
10. Display the EPG (Electronic Program Guide)(DTV mode).
11. Adjust the volume.
12. Select a channel.
13. Display the present screen information such as the current channel and the input source.
14.
  - ◀◀ : Reverse playback rapidly.
  - || : Start playback or pause.
  - FAV : Display the Favourite Channel list. (ATV/DTV Mode)
  - ▶▶ : Reverse playback rapidly.
15. To exit the teletext mode.(ATV/DTV Mode)
16. To enlarge the picture on the TV in teletext.(ATV/DTV Mode)
17. Turn on and off the teletext function. (ATV/DTV Mode)
18. Display the subtitles broadcast with the program (DTV mode).
19.
  - **HOLD** : Freeze a multi-page passage on the screen in Teletext.(ATV/DTV Mode)
  - **PVR STOP** : Stop the PVR recording.
20.
  - **INDEX** : Press to select the page number of the INDEX from teletext. (ATV/DTV Mode)
  - **AUDIO** : Adjust the audio in VGA automatically.
21.
  - **REVEAL** : Hidden information such as the answer to a quiz in Teletext. (ATV/DTV Mode)
  - ● : Record the current programme. (DTV Mode)
22.
  - **SUBPAGE** : Displays the subpage on the teletext screen.(ATV/DTV Mode)
  - **TIME SHIFT** : Turn on and off the Timeshift function.(DTV Mode)
23. **COLOUR BUTTON** : Access to corresponding function in APP service.



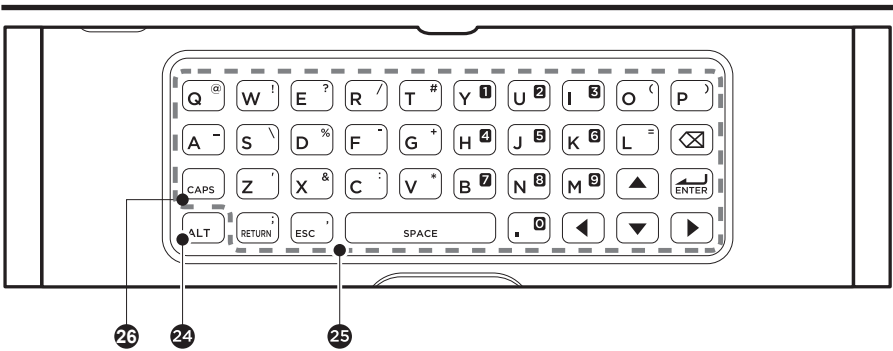

24. Use the ALT button to convert to the blue special symbols and numbers.
25. Use to control the letter keys and make the desired words.
26. Use to switch letter case.

### Remote Control Set Up

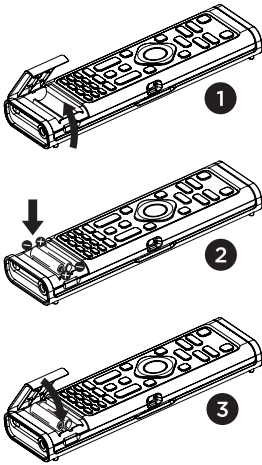

1. Remove the battery compartment cover.
2. Insert 2xAAA batteries with correct polarity (+/-) as indicated.
3. Replace the cover.

### Remote Control Set Up

Hold the remote control horizontally and push it out of the back shell, then turn it upside down.

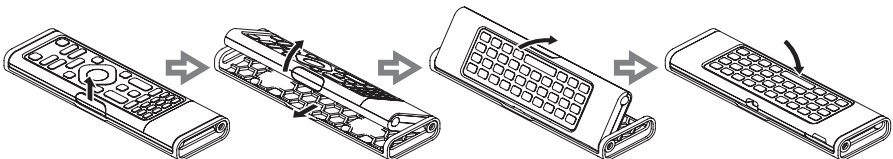

# CONNECTING EXTERNAL DEVICES

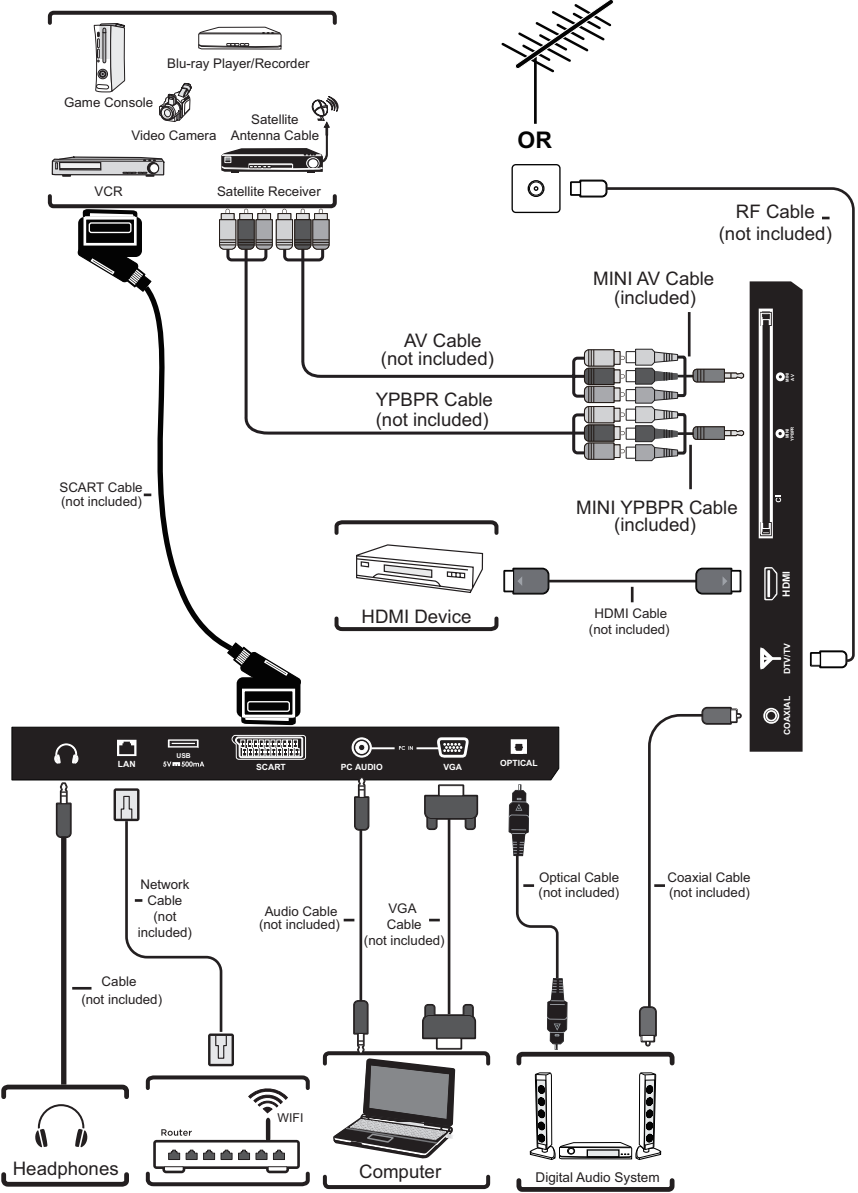

## CUSTOMIZING TV SETTINGS

### Initial Setup

- Connect the power cord to the power socket after you have completed all the physical connections. At this stage, the TV will enter Standby Mode and the red LED indicator will illuminate.
- In Standby Mode, press the **⏻** button on the main unit or on the remote control to turn the TV on. The red LED indicator will turn blue.
- The first time you turn your TV on it will go straight to the **WELCOME** screen.

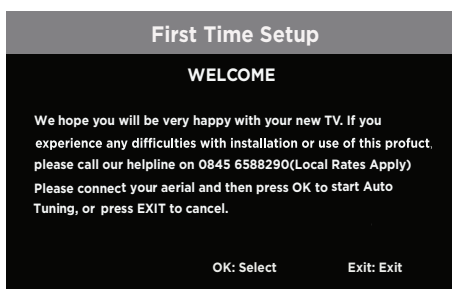

- After pressing the **OK** button you will go to the **First Time Setup** menu.

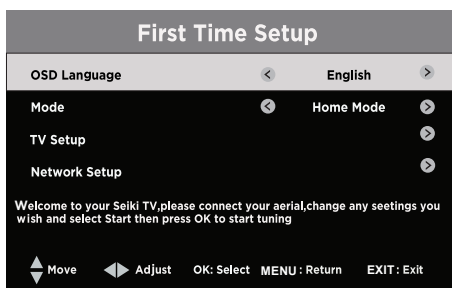

### OSD Language

- Use **▲/▼** buttons to select your desired language to be displayed on the menu , English/Francais/Español/Deutsch/Italiano/Portugue. The default on-screen menu language is set as English.

### Mode

- Use **▲/▼** buttons to select the desired mode: Home Mode/Store Mode

TV Setup

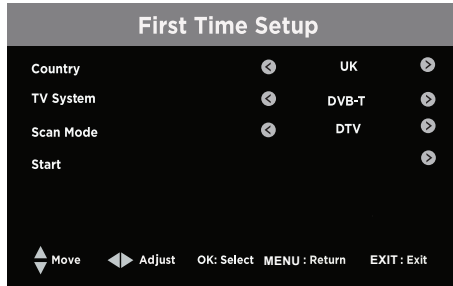

<b>Country</b>	Selects the country where you will operate the TV. The default country is set as UK.
<b>TV System</b>	Selects the desired TV system: DVB-T
<b>Scan Mode</b>	Scan and select the tune type: ATV+DTV/DTV/ATV.
<b>Start</b>	After finishing all the preliminary settings, press the <b>OK</b> button to start auto tuning. Channel Tuning will commence. This operation may take up to several minutes. The display will show the progress of the tuning and the number of channels found.

Network Setup

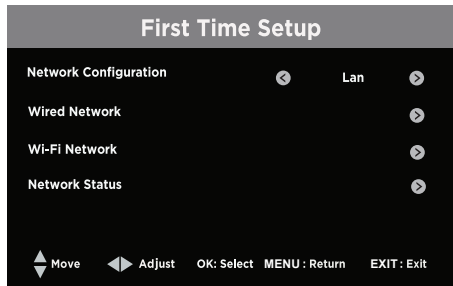

- Use ▲/▼ buttons to select your desired network type: Lan/Wireless, then connect to the network.

## ■ Navigating the Setup Settings

- Press the **MENU** button to display the main menu.
- Use **▲/▼** buttons to select **SETUP** menu and then press **◀/▶** buttons to navigate and select the available menu.



## ■ STREAMING

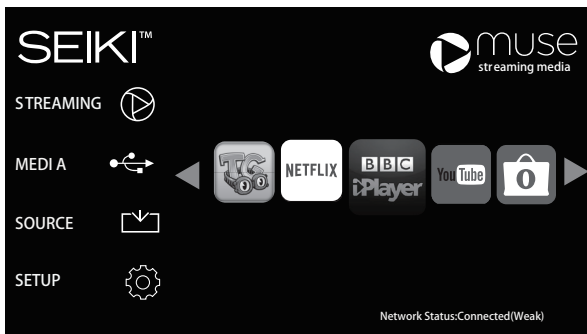

- Press the **MENU** button on the main unit or on the remote control to display the **STREAMING**. Then press **◀/▶** buttons to select the desired APP and press **OK** button to view what you want. Or press the hotkey on the remote control to enter the APP directly.

**Note:** After the TV connects to network, the status *Unconnected* will alter to *Connected(Weak/Strong)*.

## CUSTOMIZING TV SETTINGS

<b>Toongoggles</b>	A subscription video on-demand platform that offers animated, fun and educational cartoons, engaging games and songs from all over the world and in many different languages to children.
<b>NETFLIX</b>	Enjoys TV shows & movies streamed instantly over the Internet.
<b>BBC iPlayer</b>	Enjoy BBC iPlayer exclusives and your favourite BBC programmes from the last 30 days.
<b>YouTube</b>	YouTube your way on the best screen in your house.
<b>Opera TV Store</b>	Opera TV Store apps run from the cloud and suite any screen size or resolution. App categories span Video, Music, Social Networking, Games, News and Information, making it easier for users to discover and enjoy the extensive portfolio.
<b>BBC SPORT</b>	Watch exclusive live sporting events and catch-up on the latest video highlights, results and headlines.
<b>BBC NEWS</b>	Get the latest breaking news from the BBC and our global network of journalists.
<b>AccuWeather</b>	Displays the current weather conditions and the temperature anywhere in the world in centigrade or Fahrenheit.

## MEDIA



**NOTE:** Portable storage devices( USB disk or Hard disk) should be inserted.

- Press the **MENU** button on the main unit or on the remote control and then press **▲/▼** buttons to select the **MEDIA**, and then press **OK** button to enter.

## ■ Viewing Photos

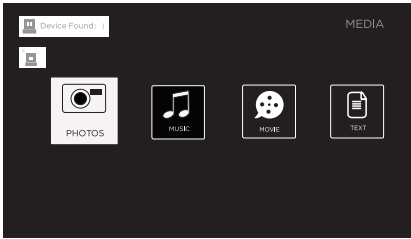

- After entering **MEDIA**, press **◀/▶** buttons to select **PHOTOS** and then select the desired disk type to enter. Then use **▲/▼ / ◀/▶** buttons to navigate in the picture folder and then press **OK** button enter. When selecting the desired picture, a thumbnail screen will pop up. Then press **▶||** button to display.

**Note:** File format supported: **JPEG/JPG**.

## ■ Listening to Music

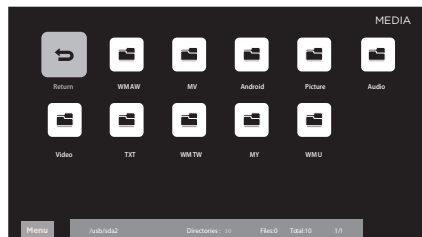
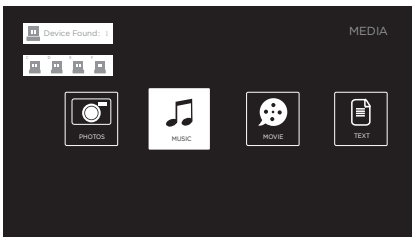

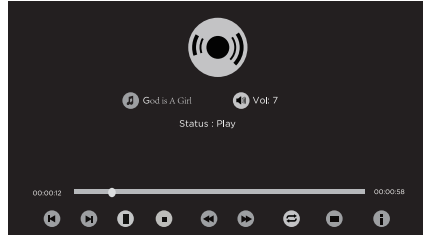

- After entering **MEDIA**, press ◀/▶ buttons to select **MUSIC** and then select the desired disk type to enter. Then use ▲/▼ / ◀/▶ buttons to navigate in the music folder and then press **OK** button enter. When selecting the desired music, a thumbnail screen will pop up. Then press ▶|| button to display.

**Note:** File format supported: **MP3**.

### ■ Viewing Movies

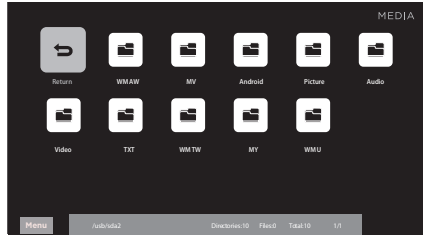
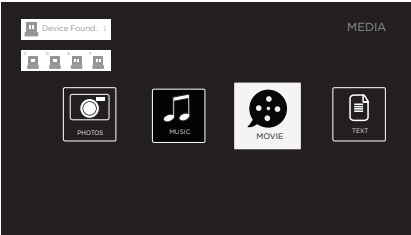

- After entering **MEDIA**, press ◀/▶ buttons to select **MOVIE** and then select the desired disk type to enter. Then use ▲/▼ / ◀/▶ buttons to navigate in the movie folder and then press **OK** button enter. When selecting the desired movie, a thumbnail screen will pop up. Then press ▶|| button to display.



## ■ My Text

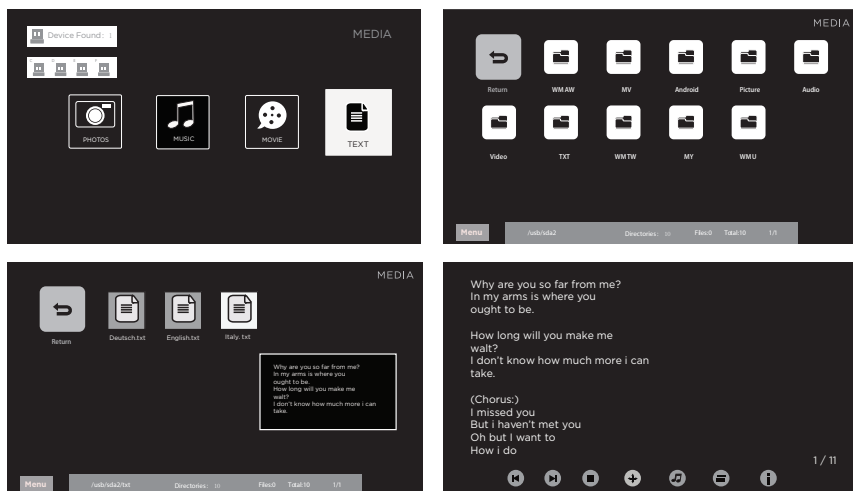

- After entering **MEDIA**, press ◀/▶ buttons to select **TEXT** and then select the desired disk type to enter. Then use ▲/▼ / ◀/▶ buttons to navigate in the text folder and then press **OK** button enter. When selecting the desired text, a thumbnail screen will pop up. Then press ▶|| button to display.

## ■ SOURCE

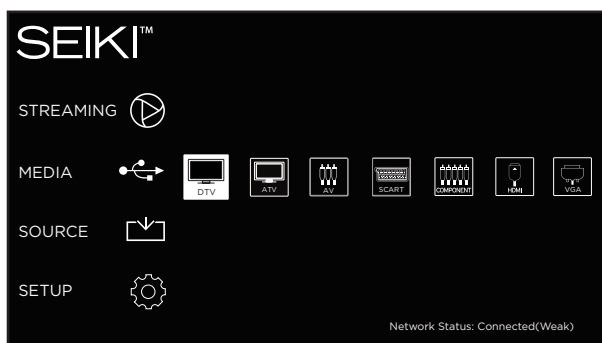

- Press the **MENU** button on the main unit or on the remote control and press ▲/▼ buttons to select the **SOURCE** menu. Then press ◀/▶ buttons to select different input sources among: **DTV/ATV/AV/SCART/COMPONENT/HDMI/VGA** and press **OK** button to confirm.

**SETUP**

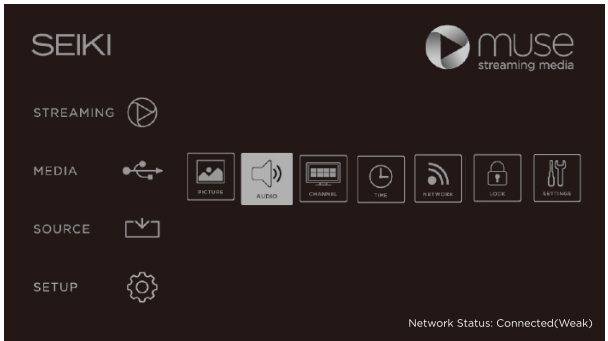

- Press the **MENU** button on the main unit or on the remote control to display the main interface. Then press **▲/▼** buttons to select **SETUP** menu and press **◀/▶** button to select the desired option.

**SETTINGS**

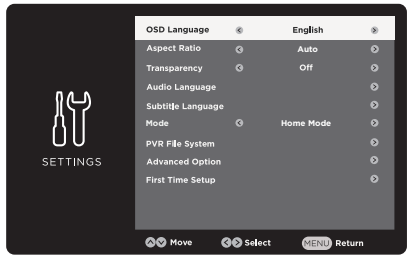

- Press **◀/▶** buttons to select **SETTINGS** menu and then press **OK** button to enter. Press **▲/▼** buttons to select the following setting options and then press **◀/▶** buttons to adjust each option's setting.

<b>OSD Language</b>	Select your desired OSD language among English/ Francés/Español/Deutsch/Italiano/Portugues.
<b>Aspect Ratio</b>	Choose to view the TV picture in various formats among Auto/4:3/16:9/Zoom2/Zoom1
<b>Transparency</b>	Select to turn On/Off transparency function.
<b>Audio Language</b>	Allows you to select your desired primary or secondary audio language. (Available for digital channels if multiple audio languages are broadcast.)
<b>Subtitle Language</b>	Allows you to select Subtitle, primary or secondary subtitle language, Hearing Impaired. (Available for digital channels if multiple subtitle languages are broadcast.)
<b>Mode</b>	Press <b>▲/▼</b> buttons to select Mode and then press the <b>◀/▶</b> buttons to select your desired mode: Home Mode/ Store Mode. <ul style="list-style-type: none"> <li>• Home Mode: Viewing at home.</li> <li>• Store Mode: For store demo, the brightness is higher than home mode.</li> </ul>

<b>PVR File System</b>	<p>Select to set the PVR File System settings.</p> <p><b>File Manager:</b> To manage the file.</p> <p><b>Select Disk:</b> Select the disk where you want to store your recorded content.</p> <p><b>Time Shift Size:</b> Select your desired file size: 512MB, 1GB, 2GB, 4GB.</p> <p><b>Format:</b> to start formatting.</p> <p><b>Speed:</b> This shows you the transfer rate of your USB storage device.</p>
<b>Advanced Option</b>	Adjust advanced option's setting:H-POS,V-POS,Clock, Phase or Auto.(VGA source mode only)
<b>First Time Setup</b>	Allows you to select the OSD language and the country where you will operate the TV the first time. Then it will search automatically for TV programmes.
<b>Reset</b>	Restore the TV to factory default settings.

■ AUDIO

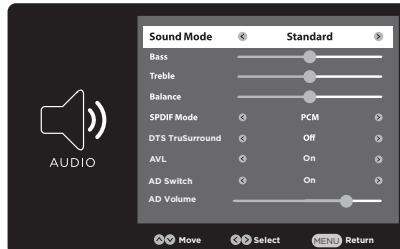

- Press ◀/▶ buttons to select **AUDIO** menu and then press **OK** button to enter. Press ▲/▼ buttons to select the following audio options and then press ◀/▶ buttons to adjust each option's setting.

<b>Sound Mode</b>	Allow the selection of an audio-enhancement technique: Standard/Music/Movie/User.
<b>Bass</b>	Control the relative intensity of lower-pitched sounds.
<b>Treble</b>	Control the relative intensity of higher-pitched sounds.
<b>Balance</b>	Adjust the relative volume of the speaker in a multiple speaker system.
<b>SPDIF Mode</b>	Select the digital audio output mode between Auto/PCM/off.
<b>DTS TruSurround</b>	Switches the virtual surround sound feature on or off. For DTS patents, see <a href="http://patents.dts.com">http://patents.dts.com</a> . Manufactured under license from DTS Licensing Limited.DTS,the Symbol, & DTS and the Symbol together are registered trademarks, and DTS TruSurround is a trademark of DTS,Inc. DTS,Inc.All RightsReserved.
<b>AVL</b>	Volume levels are automatically controlled to On or Off.
<b>AD Switch</b>	Audio Description is an auxiliary audio function that provides an additional audio track for visually challenged persons.

## CUSTOMIZING TV SETTINGS

<b>AD Switch</b>	<ul style="list-style-type: none"> <li>• set to "Off" for normal broadcasting sound coming out from speakers.</li> <li>• set to "On" to activate the description sound track if available.</li> </ul>
<b>AD Volume</b>	Set the volume of the description sound track: On/Off.

## PICTURE

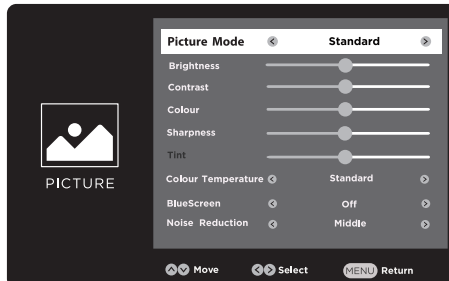

- Press ◀/▶ buttons to select **PICTURE** menu and then press **OK** button to enter. Press ▲/▼ buttons to select the following picture options and then press ◀/▶ buttons to adjust each option's setting.

<b>Picture Mode</b>	Cycle among picture mode: Standard/Dynamic/Movie/User/.
<b>Brightness</b>	Increase or decrease the amount of white in the picture.
<b>Contrast</b>	<i>Adjust the difference between light and dark levels in the pictures.</i>
<b>Colour</b>	<i>Control the colour intensity.</i>
<b>Sharpness</b>	<i>Adjust the level of crispness in the edges between light and dark areas of the picture.</i>
<b>Tint</b>	<i>Adjust the balance between red and green levels.</i>
<b>Colour Temperature</b>	Cycle among colour temperatures: Standard/Warm/Cool.
<b>BlueScreen</b>	Allow the blue background to turn On/Off during weak or no signal conditions.
<b>Noise Reduction</b>	Reduces the noise level of the connected device: Off/Weak/Middle/Strong.
<b>Dynamic Contrast</b>	Set dynamic contrast to On/Off.

■ CHANNEL

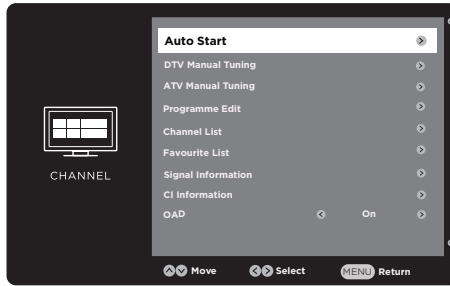

- Press ◀/▶ buttons to select **CHANNEL** menu and then press **OK** button to enter. Press ▲/▼ buttons to select the following channel options and then press ◀/▶ buttons to adjust each option's setting.

**Auto Start**

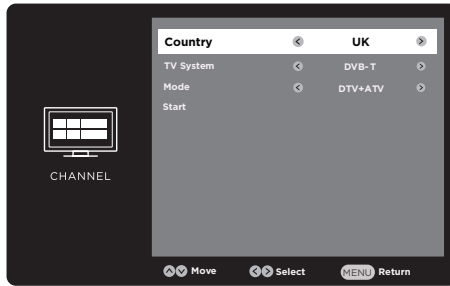

- Use ▲/▼ buttons to select the Auto Start submenu and press the **OK** button to enter. Then select the Country, TV system and Mode to start channel tuning.

**DTV Manual Tuning**

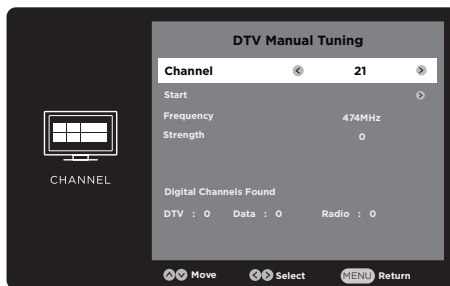

- Use ▲/▼ buttons to select DTV Manual Tuning and press **OK** on the remote control to enter. Then select the desired channel and start the DTV Manual Tuning.

**ATV Manual Tuning**

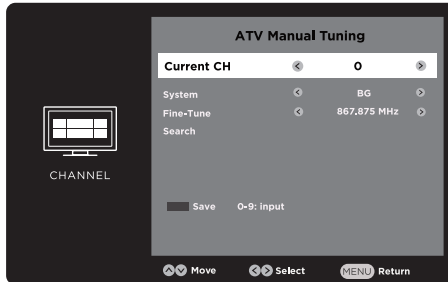

- Use ▲/▼ buttons to select ATV Manual Tuning and press **OK** on the remote control to enter. Then use ▲/▼/◀/▶ to select and adjust the desired option.

<b>Current CH</b>	Select the channel using the ◀/▶ buttons.
<b>System</b>	Select system among I / DK / L / BG.
<b>Fine-Tune</b>	Select Fine-Tune to do small adjustment to improve the signal using the buttons.
<b>Search</b>	Search through the different frequencies until you find the program you want.

**Programme Edit**



- Use ▲/▼ buttons to select Programme Edit and then press **OK** to enter.

- FAV: Use FAV button to select the desired channel and add to the favorite channel list.
- Delete: Use RED button to delete the programme from the EPG menu .
- Skip: Use BLUE button to skip the programme in the EPG menu.
- Move: Use YELLOW button to move the channel to the desired position.
- Rename: Use GREEN button to rename the programme.

## Channel List



- Use ▲/▼ buttons to select Channel List and press **OK** on the remote control to enter. Then Use ▲/▼ buttons to select the desired channel.

## Favorite List

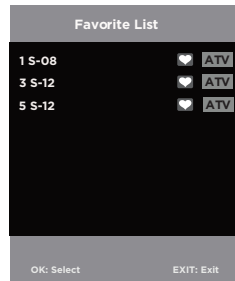

- Use ▲/▼ buttons to select Favorite List and press **OK** on the remote control to enter.

## Signal Information

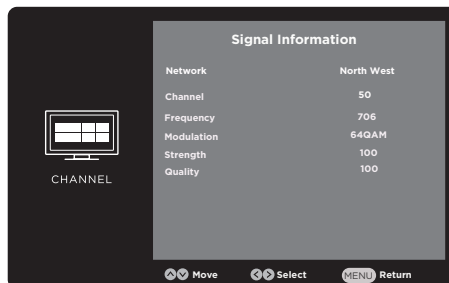

- Use ▲/▼ buttons to select Signal Information and press **OK** on the remote control to enter. This function allows you to view the signal strength of the selected channel TV signals.

### CI (Common Interface)(DTV mode)

NOTE: this function is available only when the Common Access Module is inserted to the CI slot.

This function allows you to view the common interface module information.

- Use the ▲/▼ buttons to select CI Information from the menu then press the OK button to enter.
- Press the ▲/▼ buttons to select the items and press the **OK** button to confirm.

The common interface allows the use of a Common Access Module to enable you to unscramble (pay to view) services. These services are provided by other service providers than free to view TV channels.

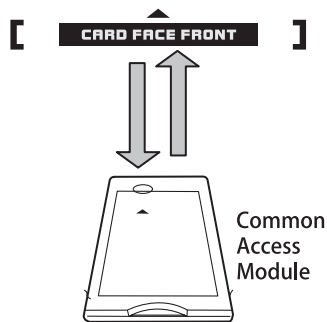

**Important:** Do not keep removing and refitting the Common Access Module as it could damage the interface and cause a malfunction.

#### Fitting the Common Access Module

**Note:** This feature is not available in all countries.

1. Before inserting the Common Access Module, please switch the TV off.
2. If you feel resistance when inserting the CAM, turn it over and try again.
3. Switch the TV on and you will be able to access the encrypted channels from the service provider.

#### Removing the Common Access Module

1. Before removing the CAM ensure the TV is switched off at the mains.
2. Pull the CAM out of the CI slot in the side of the TV.
3. Switch the TV back on at the mains.



### OAD (Software Update) (Over Air Download)

DTV mode

The TV auto detects the latest firmware update through the DTV signal and allows you to accept or refuse the firmware upgrade service.

- Press the **MENU** button to display the main menu and select **CHANNEL**. Use **▲/▼** buttons to select Software Update(OAD) to enter.
- During normal DTV viewing, if the TV detects firmware upgrade, the Over Air Download screen will appear. Use the **◀/▶** buttons to select either **Yes** or **No**.

**Note:** If you do not press any button within 1 minute, the Over Air Download screen will disappear. The Over Air Download screen will appear next time you switch to viewing a DTV channel.

### OAD Scan

- Use **▲/▼** buttons to select OAD Scan and press **OK** button to enter. To scan the Over Drive Download function.

### ■ TIME

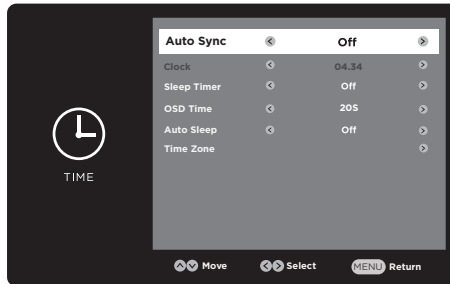

- Press **◀/▶** buttons to select **TIME** menu and then press **OK** button to enter. Press **▲/▼** buttons to select the following time options and then press **◀/▶** buttons to adjust each option's setting.

<b>Auto Sync</b>	Select to turn On or Off Auto Sync. When setting to Off, the Clock can be set. When setting to On, Time Zone can be enabled.
<b>Clock</b>	Use the <b>▲/▼</b> buttons to navigate through the menu and adjust clock settings: Date / Month / Year / Hour / Minute.
<b>Sleep Timer</b>	Select a period of time after which the TV automatically switches to standby mode: Off/10/20/30/60/90/120/180/240m in.
<b>OSD Time</b>	Displays time of the on-screen menu:10s/20s/30s/60s/Off.
<b>Auto Sleep</b>	The function will automatically switch to sleep mode when setting to On.
<b>Time Zone</b>	Select the desired local time zone.

■ NETWORK

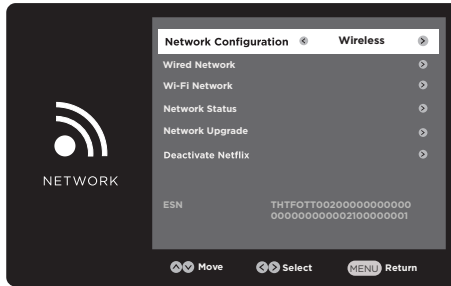

- Press ◀/▶ buttons to select **NETWORK** menu and then press **OK** button to enter. Press ▲/▼ buttons to select the following network options and then press ◀/▶ buttons to adjust each option's setting.

<b>Network Configuration</b>	Select two types of network: Wireless or Lan.
<b>Wired Network</b>	Connect the TV to wired Lan: Auto Get IP/Manual Get IP.
<b>Wi-Fi Network</b>	Connect the TV to the wireless network through searching the available Wifi.
<b>Network Status</b>	Display the current network status.
<b>Network Upgrade</b>	Upgrade the TV software through the network.
<b>Deactivate Netflix</b>	Clear the Netflix account information which you have logged in.
<b>ESN</b>	Electronic Serial Number

**Auto Upgrade**

- After the TV connects to network, the system will automatically detect software version.



- If there is a new version, it will be downloaded in the background. When you want to enter the app, a menu bar will pop up reminding you that upgrade software is downloading. Please try later...

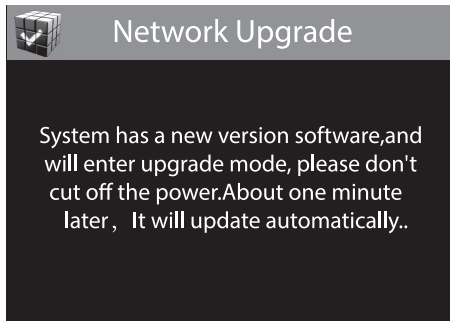

- After the download completed, it can upgrade automatically after users press the standby button.

**Note:** This procedure is fully automatic, and remember not to cut off the power.

### Manual Upgrade

- After the TV connects to network, users can detect whether there is a new version through network manual option.

### Reminder for Internet Connection:

- Below occasions are possible while your internet is connected to enjoy your OTT services.
  - 1. Please check your internet signal strength while internet is connected, signal strength below 50 may result bad connection and non-smooth picture.
  - 2. To enter OTT services, 30 second may be required for internet connection. Recommended 10Mb above internet speed.

■ LOCK

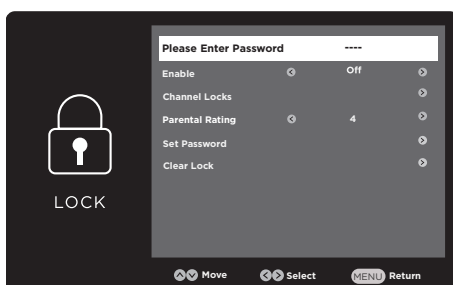

- Press ◀/▶ buttons to select **LOCK** menu and then press **OK** button to enter. Use the 0-9 buttons to input 4-digit password to enter the **LOCK** menu.
- Press ▲/▼ buttons to select the following lock options and then press ◀/▶ buttons to adjust each option's setting.

**Note:** the default password is "0000".

<b>Please Enter Password</b>	Input password before entering the lock setting.
<b>Enable</b>	When the Enable setting to On, Channel Locks can be set.
<b>Channel Locks</b>	Press green button on the remote control to lock the desired channel.
<b>Parental Rating</b>	This function allows you to set up blocking schemes to block specific channels and ratings. Press the buttons to select an age rating: Off, 4-18.
<b>Set Password</b>	Use 0-9 buttons to input the old password and then input the new 4-digit password. Re-enter new password for confirmation.
<b>Clear Lock</b>	Clear all lock settings.

## USING THE FEATURES

### Electronic Programme Guide(EPG)(DTV mode)

Your TV has an Electronic Programme Guide (EPG) to help you navigate through all your possible viewing options.

The EPG supplies information such as programme listings, start and end times for all available services. In addition, detailed information about the programme is often available in EPG (the availability and amount of programme information will vary, depending on the particular broadcast).

This function can only be used when the information is broadcast by the broadcasting companies.

The EPG displays the programme details for the next 7 days.

- Press the **EPG** button on the remote control to open the Electronic Programme Guide window.

PROGRAMME GUIDE							
16 Dec 2013	21:00-22:00	1Hour0Min	News/Current Affairs				
20:59:59 (The hour remaining, chnrs, sing for a place in the final at a celebration concert. Also in HD(4:3))							
16 Dec 2013	20:00	20:30	21:00	21:30			
1 BBC ONE	News	The Normalists are...		Ripper Street			
2 BBC TWO	Tom Kerridge Cooks ...		The chor sing While You Work				
3 BBC THREE	Snog Harry Auld?		New Don't Tell the Bride				
4 BBC FOUR	Only Connect		Shipwrecks/Britain's Sunkon History				
5 BBC Channel	This is CBBC!						
6 CBeebies	This is CBeebies!						
7 BBC NEWS	BBC News		BBC News at Nine				
8 BBC Parliament	Live House of Commons						
prev/next day				next day	schedule	remind	repeat
Prev				OK/Start	EPG/EPG	Exit/EPG	

- Use the **▲/▼** buttons to select the station you wish to watch or listen to, then press the **OK** button to tune to that station. Press the **EPG** button again to close the Electronic Programme Guide window.
- You can also look through all of the programmes available over the next 7 days by pressing the **▶** button to enter the programmes listings.

Use the **▲/▼/◀/▶** buttons to scroll through the programmes, a brief description will be shown in the window near the top of the window.

At the bottom of the window there are additional feature buttons you can use.

#### **RED button: Prev.**

Press the yellow button to scroll through the previous 7 days of programmes.

Note: This only works if the broadcaster supports this function.

#### **GREEN button: Next.**

Press the yellow button to scroll through the next 7 days of programmes.

Note: This only works if the broadcaster supports this function.

#### **YELLOW button: Schedule.**

Press the yellow button to schedule programmes.

**Note:** This only works if the broadcaster supports this function.

#### **BLUE button: Remind.**

Press this button to open the **Reminder Setting** window.

To set the reminder, scroll to the programme you want to set the reminder for on the EPG menu using the ▲/▼/◀/▶ buttons. Then press **OK** button to save the settings.

Your TV will now automatically turn its self on (if in standby mode) and tune to the programme when it starts.

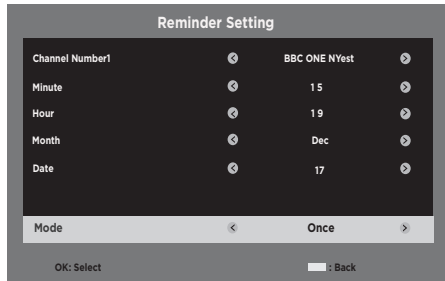

### ■ Time Shift Function(DTV mode)

This function allows you to quickly record the TV programme you are watching if you have to leave the room.

**NOTE:** You must have a USB storage device attached to your TV to use the Time Shift function.

**NOTE:** If the transfer rate of the attached USB storage device is too slow for the Time Shift function, a warning statement will be shown on the TV's screen. If this happens, please upgrade your USB storage device.

**NOTE:** Time Shift mode may not work if the station's signal strength is too weak.

**NOTE:** Always stop the Time Shift function by pressing the ■ button before switching to another input source.

### Using the Time Shift function

- To start Time Shift, press the **TIMESHIFT** button on the remote control to pause the programme you are watching. The Time Shift symbol will be displayed on screen showing that Time Shift is working.
- When you wish to resume watching the programme, press the **▶||** button on the remote control to show the PVR Time Shift progress bar.
- Use the **◀/▶** buttons to select the button on the progress bar then press the **OK** button to start watching the programme. **▶** will be displayed on screen showing you are watching a programme in Time Shift.
- Press the **■** button to stop the Time Shift recording and return to the live TV broadcast.

**Alternative:** You can press the ● (red dot) button on the remote control to display the PVR Time Shift progress bar and then use the ◀/▶ buttons to select ▶|| on the bar then press the **OK** button to start playback.

**Note:** There may be a slight delay with the video and the sound may be slightly out of sync for a few seconds when you start watching the recorded programme. This will soon disappear and the programme will play correctly.

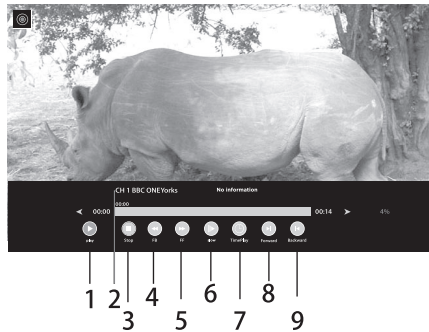

### The Time Shift progress bar

Use the ◀/▶ buttons to navigate through the progress bar. Once you have selected the feature you wish to use press the **OK** button.

- **1. PLAY:** Select to play your recording.
- **2.** Shows the channel and name of the recorded programme.
- **3. STOP:** Select to stop play back.
- **4. FB:** Select to rewind your recording at x2 / x4 / x8 / x16 / x32 speed.
- **5. FF:** Select to fast forward the recording at x2 / x4 / x8 / x16 / x32 speed.
- **6. Slow:** Select to view the recording in slow motion. Press the **OK** button multiple times choose between 2 / 4 / 8 / 16 / 32 playback speeds.
- **7. Time Play:** Select to enter a time you wish to view the recording from using the **0** to **9** buttons on the remote control.
- **8. Forward:** Select to move the recording forwards in 10% sections of the recording.
- **9. Backward:** Select to move the recording backwards in 10% sections of the recording.

### Using the remote control with Time Shift

You can use the buttons on the remote control to control playback in Time Shift.

▶|| Press to start and pause playback.

◀◀ Press repeatedly to rewind at x2 / x4 / x8 / x16 / x32 speed.

▶▶ Press repeatedly to fast forwards at x2 / x4 / x8 / x16 / x32 speed.

**Important:** To return to normal playback press the ▶|| button.

◀◀ Press to jump backwards approximately 10% of the recording time.

▶▶ Press to jump forwards approximately 10% of the recording time.

■ Press to stop the Time Shift recording.

### Recording DTV Programmes(DTV mode)

You can record digital TV programs onto a USB drive using either direct recording by pressing the red dot button or by using the program timer function.

**NOTE:** An USB disk must be inserted to the USB port on TV.

#### Instant recording

This option is used to record the program you are watching.

- Press ● record button on the remote control to record the programme you are currently watching.



The recording progress bar will be displayed, press the **EXIT** button to close recording progress bar. The recording symbol displays on the screen showing that the TV is still recording. If you want to view the recording progress bar again, press the ● button on the remote control.

- When the programme has finished and you want to stop the recording, simply press the ■ button.

**Note:** The recording will stop automatically once the USB drive is full.

**IMPORTANT:** If you want to switch off your TV during recording, press the power button on the remote control. A dialogue box will appear on the screen.



Use the ▲/▼ buttons to select either of the options:

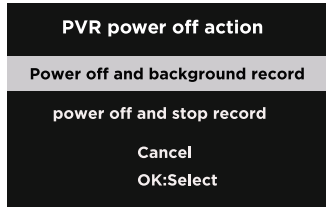

Power off and stop record: The recording will stop and the TV will go into standby mode.

Power off and background record: This option will switch the backlight light off but the recording will continue. The LED indicator will flash blue to show it is working. Press the OK button to confirm your choice or press the MENU button to cancel.

## Programme Timer(DTV mode)

The programme timer is used to schedule program recordings.

**Note:** There may be a small delay when the program starts recording. Always ensure a USB drive is inserted into the USB slot in the back of the TV. If not, a warning message will appear on the TV screen.

### Using the programme timer

This option is used to record the program you are watching.

- Press the **EPG** button on the remote control to open the Electronic Programme Guide menu.



- Use the ▲/▼ buttons to select the programme you want to record then press the ● (**Record**) button to open the Record menu.

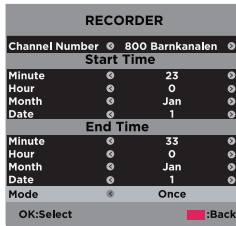

- Use the ▲/▼ buttons to select the desired option and then to start record.
- After making all of your adjustments press the OK button to confirm your settings. The Timer was saved Successfully screen will appear.

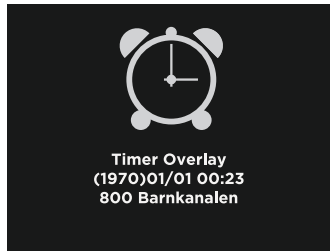

- The Schedule List will now appear at the bottom of the screen showing all of your scheduled recordings.



- You can use the colour buttons on the the remote control to change, organise and delete items in the schedule list. Press the **EXIT** button to close the menus.

**Note:** When the preset time is reached the TV will start recording automatically. If the recording starts when the TV is in standby mode the LED indicator on the front of the TV will flash blue.

### PARENTAL CONTROL

Press the **MENU** button on the main unit or on the remote control and then press ◀/▶ buttons to select **LOCK** menu. Use the **0-9** buttons to input the 4-digit password to enter the **LOCK** menu. If used, this option feature can "block" undesirable programming from appearing on the TV. Parental Control offers the user a wide variety of options and settings that restrict or "block" the programming that can appear on the TV. Parental Control allows the user to define which program rating they consider acceptable for younger more sensitive viewer. It can be preset and turned either on or off by the user who specifies the secret 4-number code, the password. The number of hours blocked are specified. General audiences and children blocks should be both programmed into the TV's memory. Separate different viewer ratings are specified for both TV and the motion picture Industry; both rating systems should be used and based on the ages of children.

#### Overview

To ensure complete coverage for all TV programs, (movies and regular TV shows) choose a rating for MPAA, from the selections below, as well as ratings from the TV Parental Guidelines Rating Systems below, using the Age Block option for General Audiences, and for children. In addition, you may wish to add additional restrictions from the content block menu, and submenus examples below.

#### Things to Consider before Setting up Parental Control

Determine which rating you consider acceptable to the viewer. (For example, if you choose TV-PG, more restrictive ratings will be automatically blocked; the viewer will not be able to see: TV-PG, TV-14, or TV-MA rated programming.) You may block the auxiliary video source entirely. (Blocks the signal sent by the equipment, such as VCR, connected to the TV Audio/Video Input Jacks) or remain unblocked, then choose acceptable ratings. Block program "Content" based on individual parameters such as: Strong Dialog, Bad Language, Sex Scenes, Violence Scenes or Fantasy. Violent Scenes; in Content Blk option. Select a secret password, in the Set Password option, using the numbers keys on the remote control. Save the password, it is the only way to access the Parental Control menu and change rating setting, or turn off Parental Control.

- You can set different Parental Control viewing restrictions for general audiences and for children, both can be active at the same time.
- Simply specifying one content block such as Sex Scenes, will not automatically restrict the programming that appears from the video sources.
- Even if you choose to leave the AUX Inputs unblocked, the ratings you specify will automatically restrict the programming that appears from the video sources.
- You cannot disable Parental Control by disconnecting the TV from power. Block hours will be automatically reset to the original block time setting specified if power is disconnected.

## TROUBLESHOOTING

If your TV does not operate normally or cannot be turned on, please check the following troubleshooting questions. Remember also to check any other connected electronic device, such as DVD or Blu-ray player to pinpoint the problem. If the TV still fails to operate normally, please contact technical support.

### The TV does not operate properly

The TV does not respond when pressing any buttons	<ul style="list-style-type: none"> <li>The TV may freeze up during use. Disconnect the power cord from the power socket for a few minutes. Reconnect the power cord and try to operate it again as usual.</li> </ul>
TV cannot be switched on	<ul style="list-style-type: none"> <li>Check that the TV is connected to the power supply.</li> <li>Make sure all connected AV devices are switched off before switching on your TV.</li> </ul>
The remote control does not work	<ul style="list-style-type: none"> <li>Check to see if there are any objects between the TV and the remote control causing an obstruction. Ensure that you are pointing the remote control directly at the TV.</li> <li>Ensure that the batteries are installed with the correct polarity (+ to +, - to -).</li> <li>Install new batteries.</li> </ul>
Power is suddenly turned off	<ul style="list-style-type: none"> <li>Check the power of the TV. The power supply maybe interrupted.</li> <li>Check if the sleep timer is set.</li> <li>Check whether the Auto Standby is activated.</li> </ul>

### The video function does not work

No picture & No Sound	<ul style="list-style-type: none"> <li>Check whether the TV is switched on.</li> <li>Try another channel. The problem may be caused by the broadcaster.</li> </ul>
Picture appears slowly after switching on	<ul style="list-style-type: none"> <li>This is normal; the image is muted during the TV startup process. Please contact your service centre if the picture has not appeared after five minutes.</li> </ul>
No or poor colour or poor picture	<ul style="list-style-type: none"> <li>Adjust the settings in the PICTURE menu.</li> <li>Try another channel. The problem may be caused by the broadcaster.</li> <li>Check if video cables are connected properly.</li> </ul>
Horizontal/Vertical bar or picture shaking	<ul style="list-style-type: none"> <li>Check for local interference such as an electrical appliance or power tool.</li> </ul>
Poor reception on some channels	<ul style="list-style-type: none"> <li>The station or cable channel may be experiencing problems; tune to another station.</li> <li>Station signal may be weak, reposition the antenna for better reception.</li> <li>Check for sources of possible interference.</li> </ul>
Lines or streaks in pictures	<ul style="list-style-type: none"> <li>Check antenna (change the position of the antenna.)</li> </ul>
No pictures when connecting HDMI	<ul style="list-style-type: none"> <li>Check if the input source is HDMI1/HDMI2/HDMI3.</li> </ul>
Pictures appear in wrong ratio	<ul style="list-style-type: none"> <li>Adjust the Aspect Ratio settings in the SETUP menu or press the ASPECT button on the remote control.</li> </ul>

## TROUBLESHOOTING

### The audio function does not work

Picture OK but no sound	<ul style="list-style-type: none"><li>• Press the VOL +/- buttons.</li><li>• Sound muted? Press the MUTE button.</li><li>• Try another channel. The problem may be caused by the broadcaster.</li></ul>
No output from one of the speakers	<ul style="list-style-type: none"><li>• Adjust the Balance settings in the AUDIO menu.</li></ul>
Unusual sound from inside the TV	<ul style="list-style-type: none"><li>• A change in ambient humidity or temperature may result in an unusual noise when the TV is switched on or off and does not indicate a fault with the TV.</li></ul>
No sound when connecting HDMI	<ul style="list-style-type: none"><li>• Check if the input source is HDMI1/HDMI2/HDMI3.</li></ul>
Audio noise	<ul style="list-style-type: none"><li>• Keep the RF coaxial cable away from the other connected cables.</li></ul>

### Password

Lost password	<ul style="list-style-type: none"><li>• Select the SET Password setting in the LOCK menu, then enter the following master password "8899". The master password clears your previous password and allows you to enter a new password.</li></ul>
---------------	--

### There is a problem in PC mode

The signal is out of range (invalid format)	<ul style="list-style-type: none"><li>• Adjust the resolution, horizontal frequency, or vertical frequency.</li></ul>
Vertical bar or stripe on background & Horizontal Noise & Incorrect position	<ul style="list-style-type: none"><li>• Use Auto configures or adjust clock, phase, or H/V position.</li></ul>
Screen colour is unstable or show a single colour	<ul style="list-style-type: none"><li>• Check the signal cable.</li><li>• Reinstall the PC video card.</li></ul>

## Maintaining

- Do not use your TV in areas that are too hot or too cold, because the cabinet may warp or the screen may malfunction. Your TV works best in temperatures that are comfortable to you.
- Storage temperatures are 32° to 122°F(0° to 50°C)
- Working temperatures are 32° to 95°F(0° to 35°C)
- Do not place your TV in direct sunlight or near a heat source

## SPECIFICATION

Panel Size	23.6 inch diagonally
Display Type	DLED
Panel Technology	TFT
Panel 60 Hz Vs. 120 Hz	60 Hz
Display Resolution	Up to 720P
HDMI Support	1080P
Panel Resolution	1366 x 768
Aspect Ratio	16:9
Dynamic Contrast Ratio-Panel	3000:1
Response Time (G To G)	8.5 ms
Lamp Life (Typ. Hours)	30,000 hours
Horizontal Viewing Angle (At CR>20)	176
Vertical Viewing Angle (At CR>20)	176
Wall-mount(LxW-mm)	100*100 (mm)VESA

Reserve the right to change the parameters without prior notice.

## DISPOSAL INFORMATION

## Instructions for waste disposal:

Packaging and packaging aids are recyclable and should principally be recycled. Packaging materials, such as foil bag, must be kept away from children.

The cold cathode fluorescent lamp in LCD PANEL contains a small amount of mercury; please follow the local laws or regulations for disposal.

## Information for Users on Disposal of old Equipment and Batteries (European Union only)

## Information for Users in European Union Countries

These symbols indicate that equipment with these symbols should not be disposed of as general household waste. If you want to dispose of the product or battery, please consider the collection systems or facilities for appropriate recycling.

This symbol on the product or on its packaging means that your electrical and electronic device should be disposed of at the end of its service life separately from your household wastes. There are separate collection systems for recycling in EU.

**Notice:** The sign Pb below the symbol for batteries indicates that this battery contains lead.



For more information, please contact the local authority or the dealer where you purchased the product.



## SEIKI LED TV's LIMITED WARRANTY TO ORIGINAL CONSUMER

### 52 inches and Under Screen Size Models (the "Product")

This Product (including any accessories included in the original packaging) as supplied and distributed in new condition, is warranted by Tongfang Global(UK) Co. Ltd. (SEIKI) to the original consumer purchaser against defects in material and workmanship ("Warranty") as follows:

- 1. REPLACEMENT** : For a period of one (1) year from date of original consumer purchase, if this Product or any part is determined by SEIKI, or a SEIKI authorized service provider, to be defective, SEIKI will replace the Product with new or re-certified product of similar or better specification, at SEIKI's option, at no charge to the original consumer. After the one (1) year Warranty period, you must pay for all cost of Product replacement charges.  
Once the Product is replaced, the warranty resume one (1) year period from the date of original consumer purchase; and will not be extended for the replacement process. Advanced Replacement option is available only with a valid United Kingdom credit card for guarantee purpose.
- 2. PARTS** : For a period of one (1) year from the date of original consumer purchase, SEIKI will supply, at no charge to the original consumer, new, rebuilt or refurbished replacement parts in exchange for defective parts. After the one (1) year Warranty period, you must pay for the costs of all parts.
- 3. SHIPPING COSTS** : Notwithstanding the foregoing, the original consumer is responsible for any shipping charges incurred to ship the Product or part(s) to SEIKI or to an SEIKI authorized customer service provider, for diagnosis, repair or replacement. The consumer is responsible for securely packing the Product and utilizing a reliable carrier to transport to SEIKI authorized service provider.

To obtain Warranty Service and Troubleshooting information call our toll free customer service line at:

**0-845-658-8290**

Please have your model and serial number available along with your date of purchase.

You can also visit us online and REGISTER your SEIKI product at:

**WWW.SEIKI.COM**

To receive Warranty service, the original consumer purchaser must contact SEIKI for problem determination and service procedures. **Proof of purchase in the form of a bill of sale or receipted invoice, evidencing that the Product is within the applicable Warranty period(s), MUST be presented to SEIKI, or an authorized customer service provider, in order to obtain the requested service.**

#### Exclusions and Limitations

This Warranty covers manufacturing defects in materials and workmanship encountered in the normal, non-commercial use of the Product, and does not cover (a) damage or failure caused by or attributable to abuse, misuse, failure to follow instructions, improper installation or maintenance, alteration, accident, or excess voltage or current; (b) improper or incorrectly performed repairs by non-authorized service facilities; (c) onsite consumer instruction or adjustments; (d) transportation, shipping, delivery, insurance, installation or set-up costs; (e) costs of product removal, transportation or reinstallation costs; (f) ordinary wear and tear, cosmetic damage or damage due to acts of nature, accident; (g) commercial use of the Product; (h) modification of, or to any part of the Product. In addition, this Warranty does not cover images "burnt" into the screen. This Warranty applies to the original consumer only and does not cover products sold AS IS or WITH ALL FAULTS, or consumables (e.g., fuses, batteries, bulbs etc.), and the Warranty is invalid if the factory-applied serial number has been altered or removed from the Product. This Warranty is valid only in the United Kingdom, and only applies to products purchased and serviced in the United Kingdom. All replaced parts and products, and products on which a refund is made, become the property of the Warrantor.

**NO WARRANTIES, WHETHER EXPRESS OR IMPLIED, INCLUDING, BUT NOT LIMITED TO, ANY IMPLIED WARRANTIES OF MERCHANTABILITY OR FITNESS FOR A PARTICULAR PURPOSE, OTHER THAN THOSE EXPRESSLY DESCRIBED ABOVE SHALL APPLY. THE WARRANTOR FURTHER DISCLAIMS ALL WARRANTIES AFTER THE EXPRESS WARRANTY PERIOD STATED ABOVE. NO OTHER EXPRESS WARRANTY OR GUARANTY GIVEN BY ANY PERSON, FIRM OR ENTITY WITH RESPECT TO THE PRODUCT SHALL BE BINDING ON THE WARRANTOR. REPAIR, REPLACEMENT, OR REFUND OF THE ORIGINAL PURCHASE PRICE - AT THE WARRANTOR'S SOLE DISCRETION - ARE THE EXCLUSIVE REMEDIES OF THE CONSUMER. THE WARRANTOR SHALL NOT BE LIABLE FOR ANY INCIDENTAL OR CONSEQUENTIAL DAMAGES CAUSED BY THE USE, MISUSE OR INABILITY TO USE THE PRODUCT. NOTWITHSTANDING THE FOREGOING, CONSUMER'S RECOVERY SHALL NOT EXCEED THE PURCHASE PRICE OF THE PRODUCT SOLD BY SEIKI. THIS WARRANTY SHALL NOT EXTEND TO ANYONE OTHER THAN THE ORIGINAL CONSUMER WHO PURCHASED THE PRODUCT AND IS NOT TRANSFERABLE.**

**DO NOT SHIP PRODUCT TO THIS ADDRESS. PLEASE CONTACT CUSTOMER SERVICE TO OBTAIN SHIPPING ADDRESSES FOR SERVICE.**

## OTT APP SERVICE

If you want to know about these APP information or get more service. Please refer to following content.

- TG



You can call the following telephone for more help: [888-874-5411](tel:888-874-5411)

- Netflix



You can call the following telephone for more help: [866-579-7172](tel:866-579-7172)

If your matter is regarding customer service, please refer to <https://contactus.netflix.com/help> for alternative contact information.

- BBC iPlayer



You can browse the following website for more help: <http://www.bbc.co.uk/contact#tv>

- YouTube



You can browse the following website for more help:

<https://productforums.google.com/forum/#!categories/youtube/smart-tvs>

- Opera TV Store



You can browse the following website for more help: <http://www.operasoftware.com/opera-tv>

- BBC Sports



You can browse the following website for more help : <http://www.bbc.com/sport/0/27047614>



## OTT APP SERVICE

- **BBC News**



You can browse the following website for more help: <http://www.bbc.com/news/help-17655000>

- **AccuWeather**



You can send E-mail to AccuWeather for more help: [CustomerService@AccuWeather.com](mailto:CustomerService@AccuWeather.com)