

CONTENTS

Important Safety Instructions	2	Using the DVD Features	33
Safety Information	3	Using the Built-in DVD Player	33
Preparation	4	Notes on DVD playback	33
What is Included	4	Basic DVD playback Function	34-35
Front View	5	Notes on DVD Playback	35
Rear View	6	Playing Multimedia Discs	36
Installing the Base Stand	7	Using the DVD setup page	36
Removing the Stand for Wall-Mounting	7	Basic DVD playback Functions	37
Remote Control	8	Using the DVD Screen	
		Setup page	38-39
Connecting External Devices	10	Parental Control	40
Getting Started	11	Digital Reception	41
How to watch a DVD	11	Supported file formats	41
Notes on DVD playback	11	Troubleshooting	42
DVD Controls	12	Plug Replacement-UK and Ireland only	43
Initial set up	13	Specifications	44
General operation	13	Disposal Information	44
Basic Features	14	Limited Warranty	45
How to Navigate menus-Selecting Source	14		
Electronic Programme Guide (EPG) (DTV Mode)	14		
Teletext (ATV Mode)	15		
Digital Teletext (DTV Mode)	16		
Time Shift Function (DTV Mode)	17		
Recording DTV Programme onto a USB Storage Device	17		
Timer Programming	18		
Play Recorded Programme	19		
Picture Management	19		
Sound Management	20		
Channel Management	21-24		
Lock System management	25		
Setup management	25-29		
Entertainment	30		
Viewing Photo	30		
Listening to Music	31		
Viewing Movies	31		
My Text	32		

IMPORTANT SAFETY INSTRUCTIONS

- **Read these instructions** – All the safety and operating instructions should be read before this product is operated.
- **Keep these instructions** – The safety and operating instructions should be retained for future reference.
- **Heed all warnings** – All warnings on the appliance and in the operating instructions should be adhered to.
- **Follow all instructions** – All operating and use instructions should be followed.
- **Do not use this apparatus near water** – The appliance should not be used near water or moisture – for example, in a wet basement or near a swimming pool, and the like.
- Clean only with dry cloth.
- Do not block any ventilation openings. Install in accordance with the manufacture's instructions.
- Do not install near any heat sources such as radiators, heat registers, stoves, or other apparatus (including amplifiers) that produce heat.
- Do not defeat the safety purpose of the polarized or grounding-type plug. A polarized plug has two blades with one wider than the other. A grounding-type plug has two blades and a third grounding prong. The wide blade or the third prong are provided for your safety. If the provided plug does not fit into your outlet, consult an electrician for replacement of the obsolete outlet.
- Protect the power cord from being walked on or pinched particularly at plugs, convenience receptacles, and the point where they exit from the apparatus.
- Only use attachments/accessories specified by the manufacturer.
- Use only with the cart, stand, tripod, bracket, or table specified by the manufacturer, or sold with the apparatus. When a cart is used, use caution when moving the cart/apparatus combination to avoid injury from tip-over.
- Unplug this apparatus during lightning storms or when unused for long periods of time.
- Refer all servicing to qualified service personnel. Servicing is required when the apparatus has been damaged in any way, such as power-supply cord or plug is damaged, liquid has been spilled or objects have fallen into the apparatus, the apparatus has been exposed to rain or moisture, does not operate normally, or has been dropped.
- Please keep the unit in a well-ventilated environment.
- **WARNING:** To reduce the risk of fire or electric shock, do not expose this apparatus to rain or moisture. The apparatus shall not be exposed to dripping or splashing. Objects filled with liquids, such as vases should not be placed on apparatus.
- **WARNING:** The batteries shall not be exposed to excessive heat such as sunshine, fire or the like.
- **WARNING:** The mains plug is used as disconnect device, the disconnect device shall remain readily operable.
- **WARNING:** To reduce the risk of electric shock, do not remove cover (or back) as there are no user-serviceable parts inside. Refer servicing to qualified personnel.



This lightning flash with arrowhead symbol within an equilateral triangle is intended to alert the user to the presence of non-insulated "dangerous voltage" within the product's enclosure that may be of sufficient magnitude to constitute a risk of electric shock.



The exclamation point within an equilateral triangle is intended to alert the user to the presence of important operating and maintenance instructions in the literature accompanying the appliance.



This equipment is a Class II or double insulated electrical appliance. It has been designed in such a way that it does not require a safety connection to electrical earth.



Warning: To prevent the spread of fire, keep candles or other open flames away from this product at all times.

SAFETY INFORMATION



This product contains electrical or electronic materials. The presence of these materials may, if not disposed of properly, have potential adverse effects on the environment and human health. Presence of this label on the product means it should not be disposed of as unsorted waste and must be collected separately. As a consumer, you are responsible for ensuring that this product is disposed of properly.



Class 1 Laser Product. This unit utilizes a laser. Use of controls adjustments or performance of procedures other than those specified herein may result in hazardous radiation exposure.

WARNING: To prevent injury, this apparatus must be securely attached to the floor/wall in accordance with the installation instruction.

To ensure reliable and safe operation of this equipment, please carefully read all the instructions in this user guide, especially the safety information below.

Electrical Safety

- The TV set should only be connected to a main power supply with voltage that matches the label at the rear of the product.
- To prevent overload, do not share the same power supply socket with too many other electronic components.
- Do not place any connecting wires where they may be stepped on or tripped over.
- Do not place heavy items on any connecting wire, which may damage the wire.
- Hold the main plug, not the wires, when removing from a socket.
- During a thunderstorm, or when not using the television for extended period of time, turn off the power switch on the back of the television.
- Do not allow water or moisture to enter the TV or power adapter. Do NOT use in wet, moist areas, such as bathrooms, steamy kitchens or near swimming pools.
- Pull the plug out immediately, and seek professional help if the main plug or cable is damaged, liquid is spilled onto the set, if the TV set accidentally exposed to water or moisture, if anything accidentally penetrates the ventilation slots or if the TV set does not work normally.
- Do not remove the safety covers. There are no user-serviceable parts inside. Trying to service the unit yourself is dangerous and may invalidate the product's warranty. Qualified personnel must only service this apparatus.
- To avoid a battery leakage, remove batteries from the remote control, when the remote is not use for long period, or when the batteries are exhausted.
- Do not break open or throw exhausted batteries into a fire.

Physical Safety

- Do not block ventilation slots in the back cover. You may place the TV in a cabinet, but ensure at least 5cm (2") clearance all around.
- Do not tap or shake the TV screen, or you may damage the internal circuits. Take good care of the remote control.
- To clean the TV use a soft dry cloth. Do not use solvents or petroleum based fluids.
- Do not install near any heat sources such as radiators, heat registers, stoves or other apparatus (including amplifiers) that produce heat.
- Do not defeat the safety purpose of the polarized or grounding-type plug. A polarized plug has two blades with one wider than the other. A grounding plug has two blades and a third grounding prong. The wide blade, or the third prong is provided for your safety. If the provided plug does not fit into your outlet, consult an electrician for replacement of the obsolete outlet.
- Protect the power cord from being walked on or pinched particularly at plugs.
- Unplug the apparatus during lightning storms or when unused for long periods.
- Refer all servicing to a qualified service personnel. Servicing is required if the apparatus does not operate normally or if the apparatus, including the power supply cord or plug, has been damaged in any way.
- Servicing is also required if liquid has been spilled, or objects have fallen into the apparatus; when the apparatus has been exposed to rain or moisture; or if the apparatus has been dropped.
- Always connect your television to a power outlet with protective ground connection.

PREPARATION

What is Included

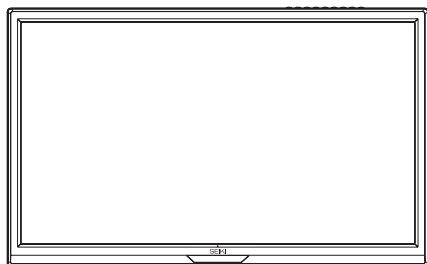

TV Set

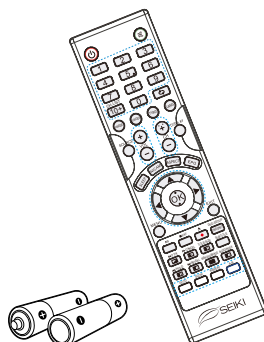

Remote Control with Batteries

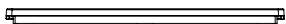

Base Stand



Stand Support

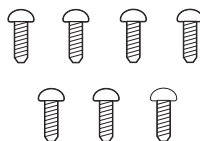

Seven Screws

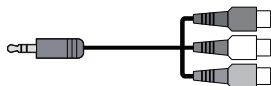

MINI AV cable

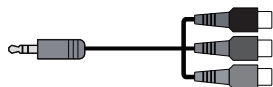

MINI YPBPR cable

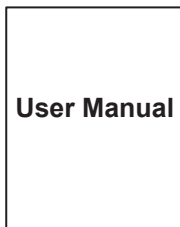

User Manual

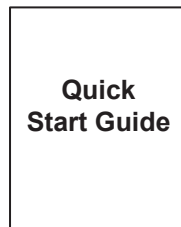

Quick Start Guide

Front View

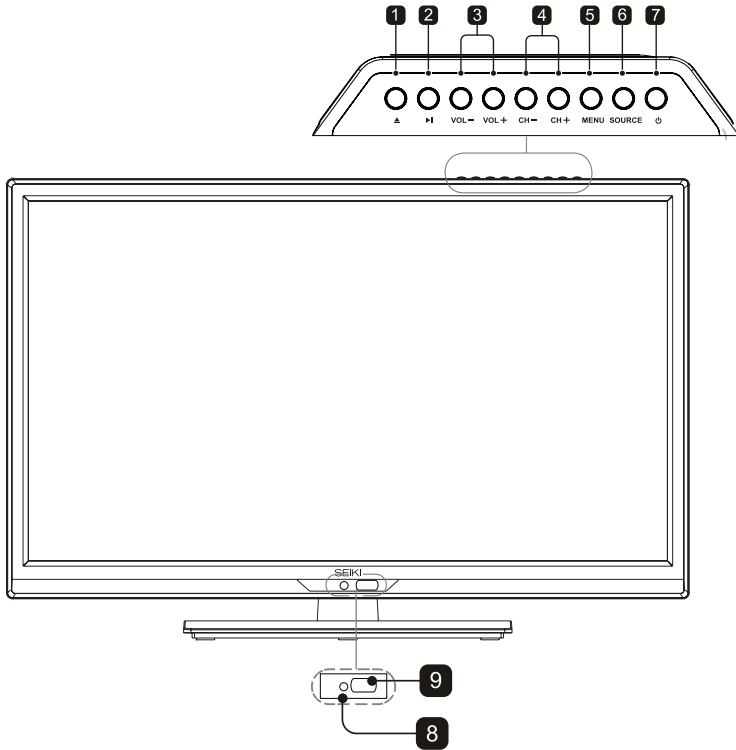

1. **▲**
Press to eject disc. (DVD mode)
2. **▶||**
Press to start playback or pause.(DVD mode)
3. **VOL -/+ button**
Decreases the volume.
Increases the volume.
4. **CH-/+ button**
Moves down a channel.
Moves up a channel.
5. **Menu button**
Displays the OSD (on screen display) menu.
6. **SOURCE button**
Press to select among different input signal sources: DTV / ATV / AV / SCART / YPbPr / DVD / HDMI / PC / USB/DVD.Confirmed the selection on OSD menu.
7. **⏻ button**
Turns the TV on when in standby mode or turns the TV off into standby mode.
8. **POWER Indicator**
Illuminate blue when the TV is turned on. Illuminate red when the TV is in standby mode.
9. **Infrared Receiver**
Receive the IR signals from the remote control.

Rear View

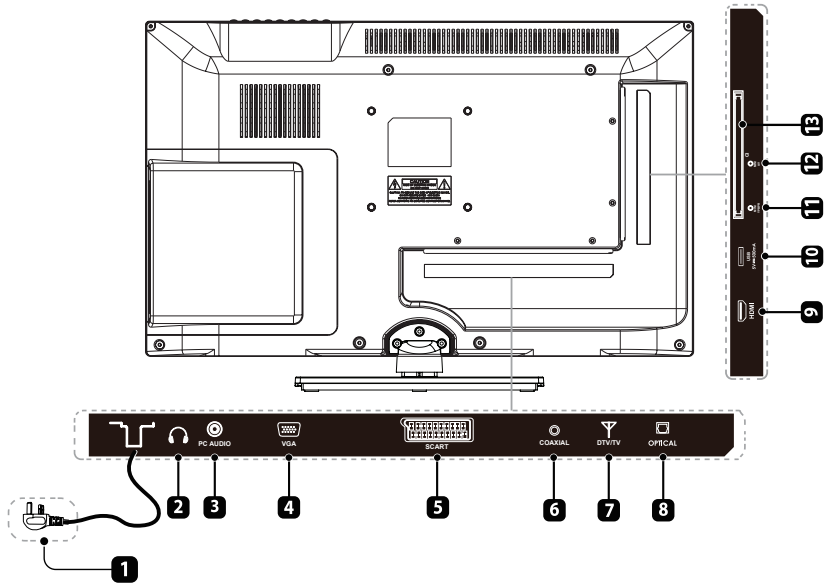

1. **Power Cord**
Connect to AC power outlet.
2. **Headphone Socket**
Connect to the composite VIDEO and AUDIO (L/R) output sockets on external video devices.
3. **PC AUDIO Input**
Connect to a computer audio output.
4. **VGA Input**
Connect to a computer or other devices with a VGA interface.
5. **SCART Socket**
Connect to SCART cable between the SCART socket on the TV and the SCART socket on the external device (decoder, or DVD player).
6. **COAXIAL Digital Audio Output**
Connect to the antenna (75Ω VHF/UHF) socket with the RF coaxial cable.
7. **DTV/TV Input**
Connect to the antenna (75Ω VHF/UHF) socket with the RF coaxial cable.
8. **OPTICAL Output**
Connect a digital sound system to this jack.
9. **HDMI Input**
Connect to a High-Defintion (HD) signal output device.
10. **USB Port**
Connect to a USB storage device to play compatible audio and photo files. (USB mode).
11. **MINI YPBPR**
Connect to AV devices with component (Y/Pb/Pr) video and audio output sockets. COMPONENT&VIDEO share with AUDIO IN(L/R)subscribe to.
12. **MINI AV**
Connect to the composite VIDEO and AUDIO (L/R) output sockets on external video devices.
13. **CI Slot**
Used to insert a CI card.A CI card allows you to view all the channels that you subscribe to.For more information,see "Conditional Access" section.

Installing the Base Stand

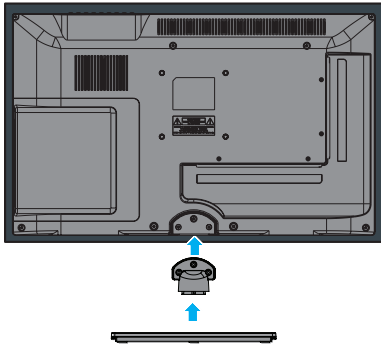

1. Lay the TV face-down on a flat, cushioned surface to avoid damaging or scratching.
2. Fix the stand support to the TV using the 3 pcs provided screws.
3. Fix the base stand to the TV using the 4 pcs provided screws.

Removing the Stand for Wall-Mounting

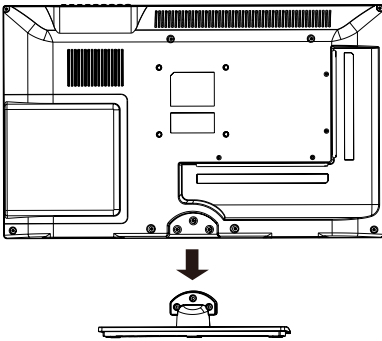

1. Lay the TV face-down on a flat, cushioned surface to avoid damaging or scratching.
2. Untighten the 3 pcs screws holding the stand assembly and remove them.
3. Attach the wall-mount bracket to the TV using the mounting holes on the back of the TV. Mount this TV according to the instructions included in the wall-mount bracket.





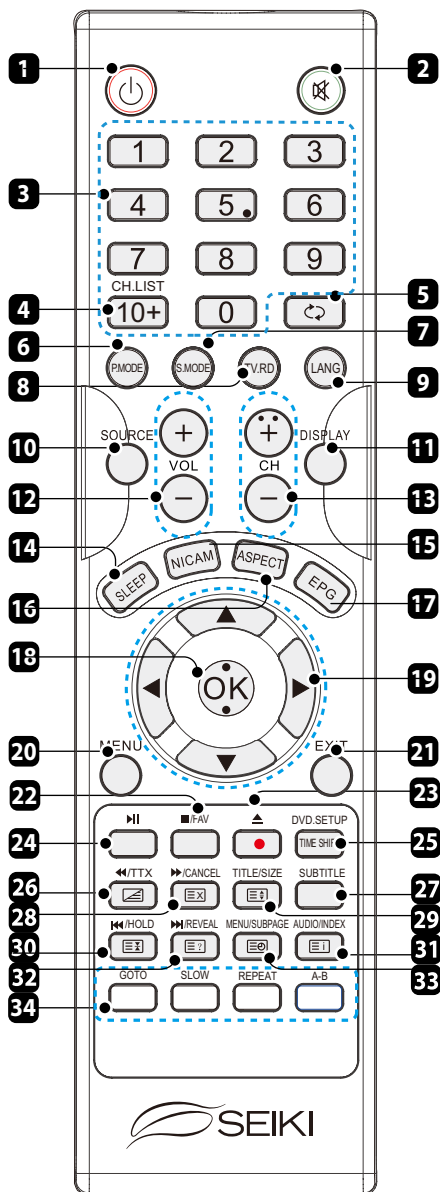





WARNING: This apparatus is intended to be supported by UL Listed wall mount bracket.

Remote Control



1. **⏻**: Switch the TV between on and standby mode.
2. **🔇**: Mute and restore your TV sound.
3. **0~10**: Select a program. (ATV/DTV mode)
4. **CH.LIST**: Display channel list.(ATV/DTV mode)
5. **↶**: Return to previous viewing channel.
6. **P.MODE**: Select picture mode: standard/mild/personal/dynamic.
7. **S.MODE**: Select sound mode: standard/music/movie/personal.
8. **TV.RD**: Select TV program or Radi o program.(DTV mode).
9. **LANG**: Select DTV audio language.(DTV mode)
10. **SOURCE**: Select among the different t input signal sources: DTV/ATV/SCART/AV/YPbPr/DVD/HDMI/PC/USB.
11. **DISPLAY**: Display the present screen information such as the current channel and the input source.
12. **VOL+/-**: Adjust the volume.
13. **CH+/-**: Select a channel.
14. **SLEEP**: Set the TV sleep timer.
15. **NICAM**: Switch between different audio channels(only applicable when the TV programme has this feature).
16. **ASPECT**: Select from the following mode settings: 16:9/Zoom1/Zoom2/Auto/4:3.
17. **EPG**: Display the EPG(Electronic Program Guide).(DTV mode)
18. **OK**: Confirm the selection in the OSD 'on screen display' menus.
19. **◀▶▲▼**: Allows you to navigate the OSD menus and adjust the system settings to your preference.
20. **MENU**: Display the OSD (On Screen Display) menu.
21. **EXIT**: Exit the OSD (On Screen Display) menu.
22. **■**: Press once to stop. (USB / DVD mode)
23. **●**: Record the current programme. (DTV mode)
24. **▶**: Ejects a disc. (DVD mode)
25. **⏮**: To start the timeshift playback. (DTV mode)
26. **⏸**: To start playback or pause. (USB / DVD mode)

Remote Control

25. **TIMESHIFT**: Start the time-shift function.(DTV mode)
DVD.SETUP: Displays the DVD OSD menu. (DVD mode)
26.  **TTX**: Turn on and off the Teletext function.(ATV/DTV mode)
: To reverse playback rapidly. (USB / DVD mode)
27. **SUBTITLE**: Display the subtitle which is broadcast with the program.(DTV mode)
28.  **CANCEL**: To exit the teletext mode. (ATV / DTV mode)
: To advance playback rapidly. (USB / DVD mode)
29.  **SIZE**: To enlarge the picture on the TV in teletext.(ATV/DTV mode)
TITLE: Display disc menu (if available). (DVD mode)
30.  **HOLD**: Freezes a multi-page passage on screen in teletext.(ATV/DTV mode)
: To skip to the beginning of the previous chapter / track / photo. (USB / DVD mode)
31.  **INDEX**: To select the page number of the index from teletext.(ATV/DTV mode)
AUDIO: Press repeatedly to switch among audio option (if available). (DVD mode)
32.  **REVEAL**: Reveals hidden information such as the answer to a quiz in teletext.
(ATV/DTV mode)
: To skip to the beginning of the next chapter / track / photo. (USB / DVD mode)
33.  **SUBPAGE**: Display the subpage on the teletext screen.(ATV/DTV mode)
MENU: Return to the main menu of a loaded DVD (if available). (DVD Mode)
34. **Coloured buttons**: Accesses the TELETEXT items or channel edit when using Digital / Freeview TV Channels. (ATV / DTV mode)
GOTO (RED): Skips to a specific location on a DVD / CD. (DVD mode)
SLOW (GREEN): Plays video slow. (DVD mode)
REPEAT (YELLOW): Selects between different repeat modes. (DVD mode)
A-B (BLUE): Repeats a segment between A and B. (DVD mode)

CONNECTING EXTERNAL DEVICES

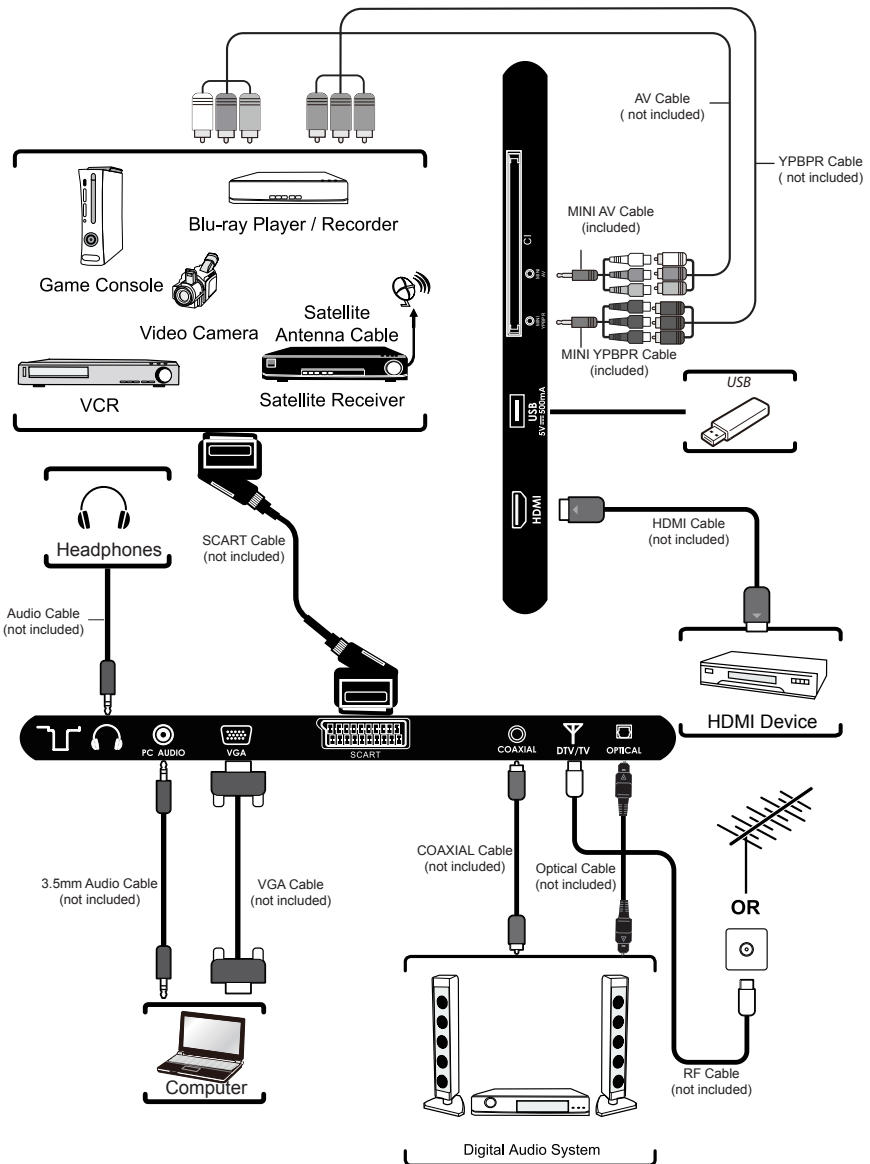

GETTING STARTED

How to watch a DVD

1. Press the "⏻" button on the TV or remote control.
2. Switch to DVD source using the "SOURCE" button on the remote control.
3. Insert a disc into the loader. The label side of the disc MUST be facing you when looking at the TV screen.

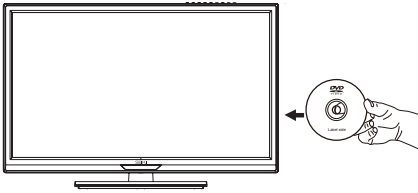

Most discs will be automatically loaded and play will start automatically if the disc does not have any menus recorded on it. If play does not start automatically, press the "▶" button on the remote control, or the "▶" button at the bottom right of the TV.

A menu may appear on the TV screen after a few moments or the film may start immediately after the Film/TV Company introduction. This will depend on the disc content and may differ on each disc.



Steps 4 and 5 are only available when a menu is recorded on the disc.

4. Press the navigation buttons "◀", "▶", "▲" or "▼" or the number buttons to select the required title.
5. Press the OK button. The selected item starts to play.

Notes on DVD playback

- No sound will be heard during Rapid advance or Rapid reverse.
- No sound will be heard during Slow motion play.
- Reverse Slow motion play is not available.
- In some cases, the subtitle language will not be changed immediately to the selected one.
- When the preferred language will not select, even after pressing the button several times, it means the language is not available on the disc.
- When the DVD player is restarted or the disc is changed, the subtitle selection is automatically changed back to the initial settings.
- If a language is selected that is not supported by the disc, the subtitle language will automatically be set to the disc's priority (default) language.
- Usually a 'circulation' will happen while switching to another language, this means you can cancel the subtitle by pressing the same button a number of times until "Subtitle Off" appears on the screen.
- When the power is turned on or the disc is removed, the language heard will be the one selected at the initial settings.
- Some DVDs may not contain root and/or title menus.
- Reverse stepping is not available.
- For reference: If you attempt to enter a number greater than the total time of the current title, the time search box disappears and "Input Invalid" message appears on top-left corner of screen.
- The slide show is disabled when the ZOOM mode is on.

GETTING STARTED

DVD Controls

You can operate DVD, movie CD, music or picture CD's content by using the correct buttons on your remote control. Below are main functions of commonly used remote control buttons.

Buttons on Remote Control	DVD Playback	Movie Playback	Picture Playback	Music Playback
▶	Play/Pause	Play/Pause	Play/Pause	Play/Pause
■/FAV	Stop	Stop	Return to the picture list	Stop
▲	Open or close the discs tray	Open or close the discs tray	Open or close the discs tray	Open or close the discs tray
DVD.SETUP	Displays the DVD OSD menu	Displays the DVD OSD menu	Displays the DVD OSD menu	Displays the DVD OSD menu
⏮/HOLD	Skip backward	Skip backward	Skip backward	Skip backward
⏪/TXX	Rapid reverse	Rapid reverse	XR	Rapid reverse
TITLE/SIZE	Display disc menu (if available)	Display disc menu (if available)	XX	
SUBTITLE	Subtitle on-off. Press repeatedly to switch between subtitle option	Subtitle on-off. Press repeatedly to switch between subtitle option	XX	
⏭/REVEAL	Skip forward	Skip forward	Skip forward	Skip forward
⏩/CANCEL	Rapid advance	Rapid advance	XR	Rapid advance
MENU/SUBPAGE	Return to the main menu of a loaded DVD (if available)	Return to the main menu of a loaded DVD (if available)	Return to the main menu of a loaded DVD (if available)	X
AUDIO/INDEX	Press repeatedly to switch among audio options (if available)	Press repeatedly to switch among audio options (if available)	X	Press repeatedly to switch among audio options (if available)
GOTO	Go to a specified track or time on a loaded disc	Go to a specified track or time on a loaded disc	XX	
SLOW	Slow down playback speed	Slow down playback speed	XX	
REPEAT	Displays repeat options	Displays repeat options	Displays repeat options	Displays repeat options
A-B	Repeat a selected section	Repeat a selected section	XR	Repeat a selected section

GETTING STARTED

Initial Setup

1. Connect one end of the RF coaxial cable to the aerial socket on the wall and the other end of the cable to the RF (75Ω) socket at the rear left side of your TV.
2. Connect the mains cable to the mains socket after you have completed all the connections.
3. Connect AC power cable. At this stage, the TV switches to standby mode. The red LED indicator will illuminate on the front panel of the TV.
4. In standby mode, press the **⏻** button at the top of the TV or the **⏻** button on the remote control to turn the TV on. The red LED indicator will turn blue.
5. The first time you turn the TV on, it will go straight into **First Time Setup** menu. Press the **◀▶▲▼** buttons to navigate the menu and change the settings.

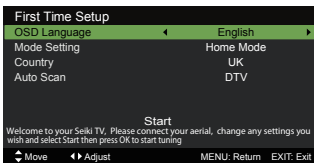

OSD Language

Selects your desired language to be displayed on the menu. The default on-screen menu language is set as English.

Mode Setting

Selects your desired mode setting.

- Home Mode: Viewing at home.
- Store Mode: For store demo, the brightness is higher than home mode.

Country

Selects the country where you will operate the TV. The default country is set as UK.

Auto Scan

Selects the auto scan type: DTV+ATV / DTV /ATV.

Start

Press the **OK** button to start auto tuning. Auto Scan will commence. The display will show the progress of the tuning and the number of channels found.

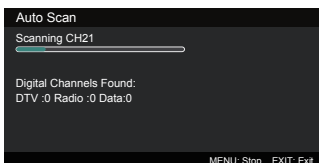

6. If you want to skip the DTV tuning, press the **MENU** button to interrupt the tuning half way.

General Operation

Press the **SOURCE** button on the remote control and select DTV to switch the TV to Digital Terrestrial Television Broadcasting.

Information Banner

Whenever you change channel using the **CH+ / CH-** buttons or the number buttons, the TV displays the broadcast picture along with an information banner on the top left of the screen (available only in DTV/ATV mode).

The information banner can be displayed at any time while watching TV by pressing the **DISPLAY** button on the remote control.

BASIC FEATURES

How to Navigate Menus- Selecting Source

1. Press the **SOURCE** button at the top of the TV or the **SOURCE** button on the remote control to display the Input source list.
2. Press the **▲▼** buttons to select the input source that you want: DTV / ATV / SCART / AV / YPbPr /DVD/ HDMI/ PC / USB.
3. Press **OK** button to confirm your selection.

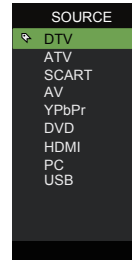

Electronic Programme Guide (EPG) (DTV Mode)

This system has an Electronic Programme Guide (EPG) to help you navigate through all the possible viewing options.

The EPG supplies information such as programme listings, start and end times for all available services. In addition, detailed information about the programme is often available in the EPG (the availability and amount of programme information will vary, depending on the particular broadcaster).

This function can be used only when the EPG information is broadcast by broadcasting companies.

The EPG displays the programme details for the next 7 days.

1. Press the **EPG** button to switch on EPG.



2. Press **EPG** button or **EXIT** button again to switch off EPG and return to normal TV viewing.

Info bar commands:

RED (Prev. Date)

Press the **RED** button to view the schedule of the previous day.

GREEN (Next Date)

Press the **GREEN** button to view the schedule of the next day.

YELLOW (Schedule)

Press the **YELLOW** button to view the preset reminders in the schedule list. Press the **YELLOW** button to return to the EPG.

BLUE (Reminder)

Press the **BLUE** button while on the selected programme, the Reminder setting menu will be displayed.

Press the **▲▼◀▶** buttons to adjust the settings and then press the Save button to confirm the settings. After confirmation, the EPG Schedule List will then be displayed with your preset reminders shown. Press the **YELLOW** button to return to the EPG. The TV will automatically tune to the selected programme when it starts.

REC

Timer Programming.

OK

Press to display detailed information of the selected programme (if available).

Teletext (ATV Mode)

Teletext is a free service broadcast by some TV stations which gives up-to-the-minute information on news, weather, television programmes, share prices and many other topics. Using the Teletext control buttons you can view pages of information that are listed in the teletext index.

To Turn on Teletext Function



Make sure the TV channel you are watching transmits teletext.
"No Teletext" sign will show on the screen if teletext is not available.

In ATV mode, press the **TTX** button to enter Teletext mode. Press the **INDEX** button to display the index page.

Press the **TTX** button once to exit and the TV will return to the channel you were watching.

To select a page of text

Find the number of the page in the index and enter it using the **0-9** buttons. The number of the page will appear on the top left corner of the screen.

The page counter will search for your page. When it finds it, the page will be displayed.

To move to the next page of text, press the **▲** button.

To move to the previous page, press the **▼** button.

To return to the index page, enter the **"100"** by using the **0-9** buttons or press the **INDEX** button.

Mix

To view a page of text while watching a TV programme, press the **TTX** button twice. The text will be superimposed over the TV programme.

Double height text

If you have difficulty reading the text on the TV you can double the height of the text.

Press the **SIZE** button. The top half of the page will be displayed in double height text.

Press the **SIZE** button again. The bottom half of the page will be displayed in double height text.

Press the **SIZE** button again to return to the full page.

Page HOLD

If the page of text you have selected contains subpages, these subpages will automatically be displayed in order with a delay to allow you to have enough time to read the page.

To stop the movie to the next sub page, press the **HOLD** button.

To continue moving through the sub pages, press the **HOLD** button again.

*Alternative: Press the **SUBPAGE** button, and then use the 0-9 buttons to enter a 4-digit page number.*

To Reveal Information

Press the **REVEAL** button to reveal concealed information (quiz answers etc.).

Press the **REVEAL** button again to conceal the information again.

Fasttext

At the bottom of the teletext screen is a row of subject headings in red, green, yellow and blue.

The remote control has a row of colour buttons corresponding to the row of coloured subjects on the screen.

Pressing one of the colour buttons will take you directly to the page corresponding to the subject heading.

Digital Teletext (DTV Mode)

Digital teletext can access special digital teletext services and specific services which broadcast digital teletext. You will need to turn off Subtitle Function before using teletext.

1. In DTV mode, press the **TTX** button to display the teletext page.



2. Press the **0-9** buttons to select a page number.
3. Follow the instructions on digital teletext and move onto the next step by pressing **OK**, **▲**, **◀▶**, **RED**, **GREEN**, **YELLOW**, **BLUE** or **0-9** buttons etc.
4. To change digital teletext service, select a different service by pressing the **0-9** buttons or the **▲▼** buttons.

*Alternative: You may press the **RED** button to the **TTX** button to display the teletext information when you see a **●** red logo displayed on the screen (e.g. BBC).*

5. Press the **TTX** button to exit.

Time Shift Function (DTV Mode)

This function allows the TV to virtually record the live viewing broadcast programme.

Note: If the transfer rate of the USB storage device is too slow for recording or time shift function, a warning statement will be shown on the screen. If this happens, please upgrade your USB storage device.



- Time Shift Mode and Recording functions may not work if the signal strength is weak.
- Stop the time-shift function before switching to another input source.

During normal TV viewing, you may press the **TIMESHIFT** button to virtually pause the live viewing broadcast programme if you want to go out for a while (e.g. going to the bathroom / kitchen). "||" will show on the screen.

When you have returned, press the **▶▶** button to display the PVR Time Shift progress bar and then press the **◀▶** buttons to select "▶" on the bar. Press the **OK** button to play the missed broadcast programme. "▶" will show on the screen.

The video and sound may have a little bit of delay or be out-of-sync for a few seconds when the unit starts to playback the missed broadcast

programme. It will soon turn to normal.



The 'PVR Time Shift Progress Bar'

- 1 Indicates the status of the currently displayed video (▶ / || / ◀▶ / ▶▶)
- 2 Indicates the time lagging behind the live broadcast (PVR reviewing)
- 3 Indicates the available recording time on your USB storage device

Time Shift Function (DTV Mode)

Using the Remote Control

You can shift playback to any point of the virtually recorded programme. Press the **TIMESHIFT** button to display the PVR Time Shift progress bar again.

TIMESHIFT

During playback, press the **TIMESHIFT** button to display a still screen.

◀◀ or ▶▶

When playing,

- Press the ◀◀ button repeatedly to speed up ◀◀ x 2 / x 4 / x 8 / x 16.
- Press the ▶▶ button repeatedly to speed up ▶▶ x 2 / x 4 / x 8 / x 16.
- During fast forward / fast backward state, press the ▶|| button to return to normal playback.

◀◀ or ▶▶

- Press the ▶▶ button to jump about 10% forward.
- Press the ◀◀ button to jump about 10% back.

▶||

- During playback, press the ▶|| button to display a still screen and then press the ▶|| button again to resume playback.
- During fast forward / fast backward state, press the ▶|| button to return to normal playback.

OK / ■

If you want to exit the PVR Time Shift progress bar and return to the current live broadcast, press the **OK / ■** button and then press the ◀ button to confirm.

Recording DTV Programme onto a USB Storage Device

Use this function to record the DTV programme you are watching on the main screen and save it for future viewing. The recording from timer programme or direct recording may have a little bit of delay when it starts to record the broadcast programme.

Please make sure the USB device is inserted. If not, a warning message will pop up.

1. Press the ● **REC** button to record the programme that you are currently watching.



To display the recording information, press the ● **REC** button.

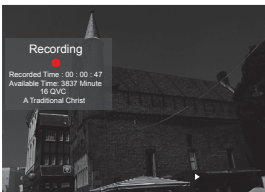

2. Press the ■ **Stop** button to stop recording.



Recording will stop automatically when the disk is full.



- If a hard disk is used, make sure its mains adapter is connected to the mains supply.
- If a USB hub is used, make sure its mains adapter is connected to the mains supply as the total current consumption may exceed 500mA.
- The maximum supported storage space of the hard disk is 1 TB.
- The file system only supports FAT32 format.
- If you want to store the video streaming of a DTV programme, the transfer rate of the USB storage device must not be less than 5MB/s, otherwise the picture and sound of the programme will be affected and a warning statement will be shown on the screen. If this happens, please upgrade your USB storage device.
- The TV screen will be blank temporarily as it will take time to start up and stabilise the connected hard disk. This is normal and the starting time may vary depending on the brand and the memory size of the connected hard disk.
- Disconnect the USB storage device if it is not in use.

Timer Programming

This function is used for scheduled recording.

The recording from timer programme or direct recording may have a little bit of delay when it starts to record the broadcast programme.

Please make sure the USB device is inserted. If not, a warning message will pop up.

1. Press the **EPG** button on the remote control. The **EPG** menu will appear.

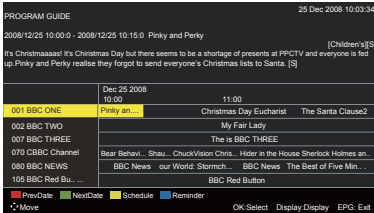

2. Press the **(REC)** button on the remote control while on the selected programme, the **Scheduled Record** menu will be displayed. Press the **▲▼◀▶** buttons to select the settings in the **RECORD** menu for the Frequency, Channel, Start time, and End time.

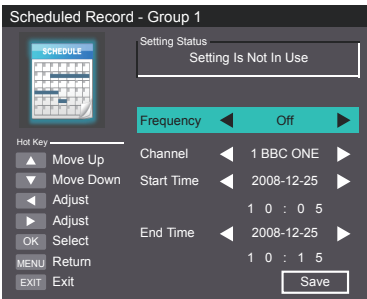

Frequency

Press the **◀▶** buttons to select the frequency (Off/Once / Daily / Weekly / Weekday).

Channel

Press the **OK** button and then press the **▲▼** buttons to select the channel that you want to record.

Start time (for Mode Once, Daily, Weekly, Weekday) Press the **▲▼◀▶** buttons to adjust the start time.

End time (for Mode Once, Daily, Weekly, Weekday) Press the **▲▼◀▶** buttons to adjust the end time.

3. After finishing all the recorder adjustments, press the **Save** button to confirm your settings.

4. The **Scheduled Record Setting List** will then be displayed with your preset reminders shown.

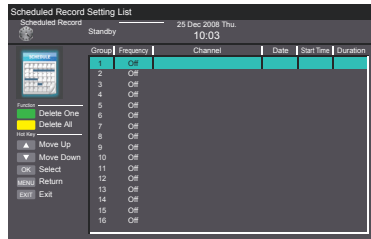

5. Press the **EXIT** button to exit EPG.



- When the preset time is reached, the TV will start recording automatically.
- If a programme recording starts when the TV is in standby mode, the LED indicator will alternatively flash red and blue.

Play Recorded Programme

You can play a recorded programme from the recorded programme list or from a USB Storage Device.

1. Press the **SOURCE** button on the top of the TV or the **SOURCE** button on the remote control then press the **▲▼** buttons to select the **USB** mode and then press the **OK** button.
2. Press the **◀▶** buttons to select **MOVIE** and then press the **OK** button.

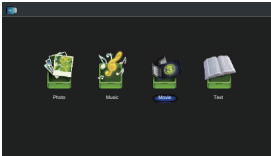

3. Press the **▲▼** buttons to select your storage device and then press the **OK** button.

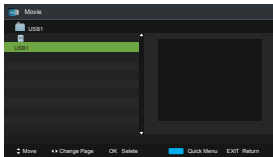

4. Press the **▲▼** buttons to select the “**usbrecord**” folder and then press the **OK** button.

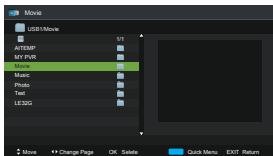

5. Press the **▲▼** buttons to select your recorded programme and then press the **▶▶** button to view.

Play Recorded Programme

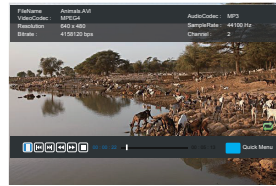

6. Press the **OK** button or the **DISPLAY** button to display the function bar. Press the **◀▶** buttons and then press the **OK** button to select the function: Pause / Prev. / Next / FB / FF / Stop / Quick Menu (Repeat / Encode Type).
7. Press the **EXIT** button to return to the previous menu.

Picture Management (ATV / DTV Mode)

1. Press the **MENU** button to display the main menu. Press the **◀▶** buttons to select **Picture** in the main menu, then press the **▼** or **OK** button, it will highlight the first option.
2. Press the **▲▼** buttons to select the option you want to adjust in Picture menu.
3. Press the **◀▶▲▼** buttons to change the following settings.

TIPS:

- You can change the value of brightness, contrast, sharpness and saturation when the picture is in Personal mode.
- You can press **P.MODE** button on the remote control to change the Picture Mode directly.

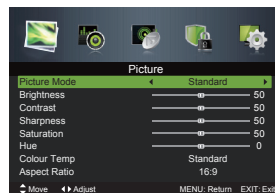

Picture Management

Picture Mode

Allows the selection of a picture-enhancement technical from among the following options: Dynamic / Standard / Mild / Personal.

Brightness

This item can adjust the optical fiber output of the entire picture; it will affect the dark region of the picture.

Contrast

This item can adjust the highlight intensity of the picture, but the shadow of the picture is invariable.

Sharpness

This item can adjust the peaking in the detail of the picture.

Saturation

This item can adjust the saturation of the colour based on your own like.

Hue

This item may use in compensating colour changed with the transmission in the NTSC code.

Colour Temp

This item can increase or reduce warm colour of the picture personally (red), and the cold colour (blue) according to your like. The choice of Cold, that means it will increase the blue tone for the white. But choosing the Warm, it will increase the red colour for the white.

Aspect Ratio

Allows you to watch the screen in various picture formats: Auto / 4:3 / 16:9 / Zoom1 / Zoom2.

Advanced Settings

- Noise Reduction: Reduces the noise level of the connected device (Medium / Strong / Off / Weak).
 - Dynamic Contrast: Adjusts the dynamic contrast (Medium / Strong / Off / Weak).
4. Press the **EXIT** button to exit menu.

Sound Management

1. Press the **MENU** button to display the main menu. Press the **◀▶** buttons to select **Sound** in the main menu, then press the **▼** or **OK** button, it will highlight the first option.
2. Press the **▲▼** buttons to select the option you want to adjust in Sound menu.
3. Press the **◀▶▲▼** buttons to change the following settings.

TIPS:

- You can change the value of treble and bass when the sound is in Personal mode.
- You can press the **S.MODE** button on the remote control to change the Sound Mode directly.

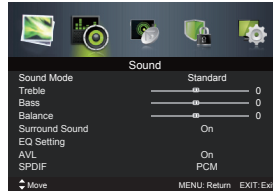

Sound Mode:

Allows the selection of an audio-enhancement technical from among the following options: Standard, Music, Movie and Personal. You can change the value of Treble and Bass when the sound is in Personal mode.

Treble

Controls the relative intensity of higher-pitched sounds.

Bass

Controls the relative intensity of lower-pitched sounds.

Balance

Adjusts the relative volume of the speakers in a multiple speaker system.

Surround Sound

Selects to turn On/Off Surround Sound.

Sound Management (ATV / DTV Mode)

EQ Setting

Allows the selection of an equalizer mode: Off / Rock/ Pop / Jazz / User. You can change the EQ value under User mode.

AVL

Selects to turn On/ Off Audio Volume Leveler.

SPDIF

Select the digital audio output mode: Auto / Off / PCM

Audio Description

Selects to turn On/Off Audio Description.

Stereo / Dual Sound Reception (ATV Mode)

When a programme is selected, press the NICAM button to display the sound information for the selected station.

Broadcast	On Screen Display
Mono	Mono
Stereo	STEREO
Dual	DUAL I, DUAL II, DUAL I+II

Mono sound selection

If the stereo signal is weak in stereo reception, you can switch to mono by pressing the **NICAM** button. In mono reception, the clarity of sound is improved. To switch back to stereo, press the **NICAM** button again.

Language selection for dual language broadcast

If a programme can be received in two languages(dual language), you can switch to DUAL I, DUAL II, DUAL I+II or Mono by pressing the **NICAM** button repeatedly.

DAUL I	Sends the primary broadcast language to the loudspeakers
DAUL II	Sends the secondary broadcast language to the loudspeakers
DAUL I+II	Sends the primary and secondary broadcast languages to the loudspeakers

Channel Management (ATV / DTV Mode)

Auto Scan

Use this to automatically find and store all available channels. This is normally recommended if some channels have been added or removed by the broadcaster or you have moved house.

1. Press the **MENU** button to display the main menu. Press the ◀▶ buttons to select **Channel** in the main menu, then press the ▼ or **OK** button, it will highlight the first option.

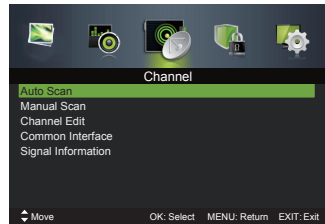

2. Press the ▲▼ buttons to select Auto Scan and then press the **OK** button to enter sub-menu.

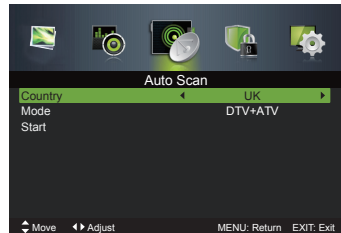

3. Press the ◀▶▲▼ buttons to navigate the menu and change the settings.

Country

Selects the country where you will operate the TV.

Mode

Selects the auto scan mode: DTV+ATV/DTV/ATV.

Start

Press the **OK** button to start auto tuning.

Channel Management (ATV / DTV Mode)

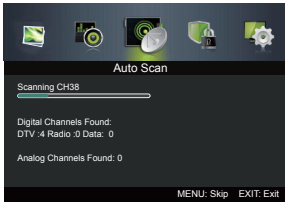

! If you stop the tuning before it has finished, the TV will report a no signal error. This is normal because all previous channel memory has been cleared before tuning is carried out.

Manual Scan (DTV Mode)

Allows you to make manual fine tuning adjustments to the channel under DTV mode.

1. Press the **MENU** button to display the main menu. Press the **◀▶** buttons to select **Channel** in the main menu, then press the **▼** or **OK** button, it will highlight the first option.

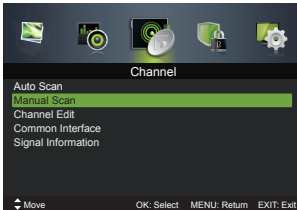

2. Press the **▲▼** buttons to select **Manual Scan** and then press the **OK** button. On the sub-menu, select Digital Manual Scan and then press the **OK** button.

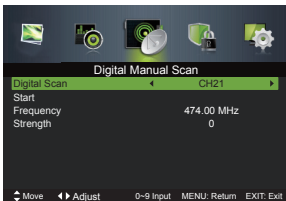

Digital Scan

Press the **◀▶** buttons to select the desired channel.

Start

Press the **▲▼** buttons to select Start and then press the **OK** button to start tuning.

Manual Scan (ATV Mode)

Allows you to make manual fine tuning adjustments if the channel reception is poor under ATV mode.

1. Press the **MENU** button to display the main menu. Press the **◀▶** buttons to select **Channel** in the main menu, then press the **▼** or **OK** button, it will highlight the first option.

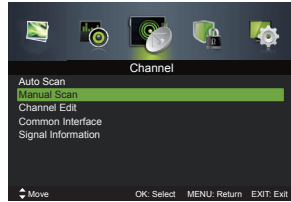

2. Press the **▲▼** buttons to select **Manual Scan** and then press the **OK** button. On the sub-menu, select Analog Manual Scan and then press the **OK** button.

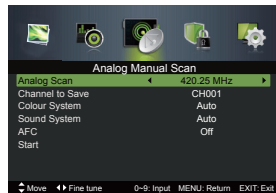

Analog Scan

Displays the current frequency, press the **◀▶** buttons to change the frequency.

Channel to Save

Press the **▲▼** buttons to select Channel to Save, press the **◀▶** buttons to select channel number you want to store.

Colour System

Press the **▲▼** buttons to select Colour System, press the **◀▶** buttons to select: Auto / PAL/ SECAM.

Sound System

Press the **▲▼** buttons to select Sound System, press the **◀▶** buttons to select: DK/I / BG.

AFC

Press the **▲▼** buttons to select AFC, press the **◀▶** buttons to select On or Off.

Start

Press the **▲▼** buttons to select Start, press the **◀▶** buttons to start tuning.

Channel Management (ATV / DTV Mode)

Channel Edit (DTV mode)

1. Press the **MENU** button to display the main menu. Press the **◀▶** buttons to select **Channel** in the main menu, then press the **▼** or **OK** button, it will highlight the first option.

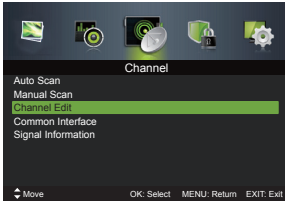

2. Press the **▲▼** buttons to select **Channel Edit** and then press the **OK** button to enter sub-menu.

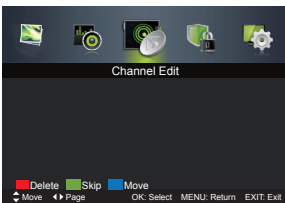

Delete

Press the **RED** button to delete the selected channel.

Skip

Press the **GREEN** button to select the channels that you want to skip when you are selecting channels. Press the **GREEN** button again to undo it.

Move

Press the **BLUE** button and then press the **▲▼** buttons to move to the selected channel. Press the **BLUE** or the **OK** button to confirm.

Channel Edit (ATV mode)

1. Press the **MENU** button to display the main menu. Press the **◀▶** buttons to select **Channel** in the main menu, then press the **▼** or **OK** button, it will highlight the first option.

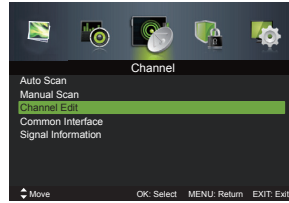

2. Press the **▲▼** buttons to select **Channel Edit** and then press the **OK** button to enter sub-menu.

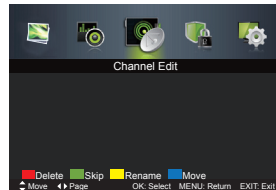

Delete

Press the **RED** button to delete the selected channel.

Skip

Press the **GREEN** button to select the channels that you want to skip when you are selecting channels. Press the **GREEN** button again to undo it.

Rename

Press the **YELLOW** button to rename the selected channel. Press the **▲▼** buttons to select the characters to represent the station name. Press the **◀▶** buttons to move to the next character and then press the **OK** button again to confirm the new name.

Move

Press the **BLUE** button and then press the **▲▼** buttons to move to the selected channel. Press the **BLUE** or the **OK** button to confirm. Press the **◀▶** buttons to select: Auto / PAL.

Favorite List

Press the **FAV** button to display the Favorite List, press the **GREEN** button to set the channel that you are currently watching as one of the favorite programmes. Press the **RED** button to delete the selected channel.

Channel Management (ATV / DTV Mode)

Common Interface (DTV mode)

To view the module information.

1. Press the **MENU** button to display the main menu. Press the **◀▶** buttons to select **Channel** in the main menu, then press the **▼** or **OK** button.
2. Press the **▲▼** buttons to select **Common Interface** and then press the **OK** button.

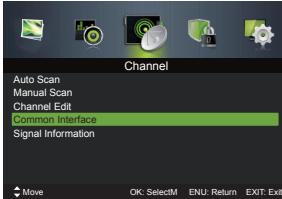

3. A Common Interface main menu will pop up. Press the **▲▼** buttons to select the items and press the **OK** button to confirm.

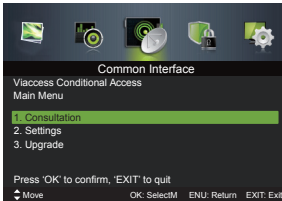

4. Press the **EXIT** button to exit the menu.

The common interface allows the use of a Common Access Module to enable you to view scrambled (pay to view) services. These services are provided by TopUp TV (UK only) and others. The Common Access Module and viewing card can be obtained from the service provider.

 Do not repeatedly insert or remove the Common Access Module as this may damage the interface and cause a malfunction.

This feature is not available in all country.

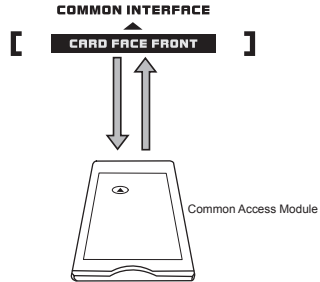
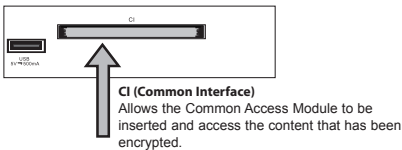

To insert the Common Access Module

1. Before you insert the Common Access Module, ensure that the TV is switched off and the viewing card is inserted **in accordance with the Service Provider's instructions**.
2. Insert the Common Access Module into the slot. Flip the Common Access Module to another side and try again if you feel resistance.
3. Switch the TV on.

To remove the Common Access Module

1. Before you remove the Common Access Module, ensure that the TV is switched off.
2. Pull the Common Access Module from the slot.
3. Switch the TV on.

Signal Information (DTV mode)

1. Press the **MENU** button to display the main menu. Press the **◀▶** buttons to select **Channel** in the main menu, then press the **▼** or **OK** button.
2. Press the **▲▼** buttons to select **Signal Information** and then press the **OK** button to view the Signal Information.

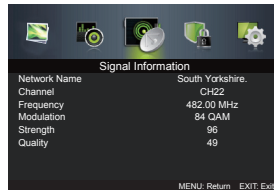

3. Press the **EXIT** button to exit the menu.

Lock System Management

1. Press the **MENU** button to display the main menu. Press the ◀▶ buttons to select **Lock System** in the main menu, then press the ▼ or the **OK** button, it will highlight the first option.
2. Use the **0-9** buttons to input a 4-digit password to enter the Lock System menu.
3. Press the ▲▼ buttons to select the option you want to adjust in Lock System menu.
4. Press the ▲▼◀▶ buttons to change the following settings.

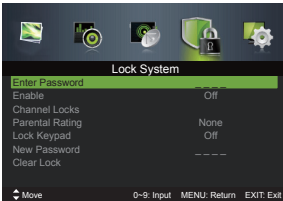

Default password "0000".

If you change the password, be sure to remember the new password! If you forget the new password, press the master password "8899".

Enter Password

To access the Lock System menu, you must enter the password. Enter the default password "0000" for the first time use.

Enable

The lock system is designed to prevent accidental returning of the TV/losing channels and prevent children watching unsuitable programme.

The Lock System must be set to On for this function to operate. If the Lock System is set to On, a valid password must be entered when you access Auto Scan / Manual Scan / Channel Edit /First Time Setup.

Channel Locks

Channel Locks is designed to prevent children watching unsuitable programmes. When a channel is blocked, a valid password must be entered.

Parental Rating

This function allows you to set up blocking schemes to block specific channels and ratings. Press the ◀▶ buttons to select an age rating: None, 4-18.

Lock System Management

Lock Keypad

Key Lock is designed to prevent children from pressing the buttons on the TV. The Lock System must be set On for this function to operate.

New Password

Use the **0-9** buttons to input the old password and then input the new 4-digit password. Re-enter new password for confirmation.

Clear Lock

Reset all the lock settings to the factory defaults.

5. Press the **EXIT** button to exit the menu.

Setup Management

OSD Language

1. Press the **MENU** button to display the main menu. Press the ◀▶ buttons to select **Setup** in the main menu, then press the ▼ or the **OK** button, it will highlight the first option.
2. Press the ▲▼ buttons to select **OSD Language** and then press the ◀▶ buttons to select your desired on-screen display language.

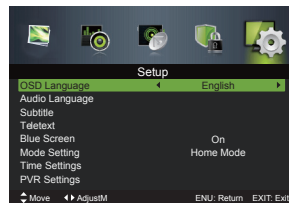

3. Press the **EXIT** button to exit the menu.

Setup Management

Audio Languages (DTV Mode)

1. Press the **MENU** button to display the main menu. Press the **◀▶** buttons to select **Setup** in the main menu, then press the **▼** or the **OK** button, it will highlight the first option.
2. Press the **▲▼** buttons to select **Audio Languages** and then press the **OK** button.

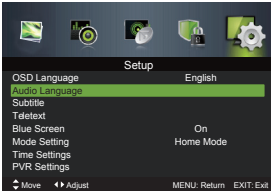

3. Press the **◀▶** buttons to select your desired Audio Primary Language. Press the **▼** button and then press the **◀▶** buttons to select your desired Audio Secondary Language.

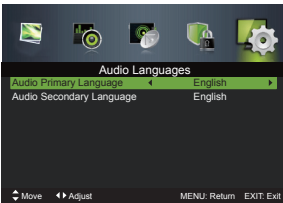

4. Press the **EXIT** button to exit the menu.

Subtitle (DTV Mode)

1. Press the **MENU** button to display the main menu. Press the **◀▶** buttons to select **Setup** in the main menu, then press the **▼** or the **OK** button, it will highlight the first option.
2. Press the **▲▼** buttons to select **Subtitle** and then press the **OK** button to enter sub-menu.

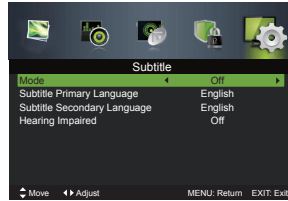
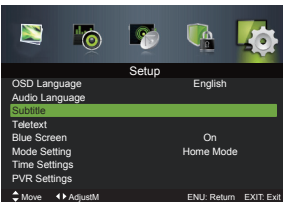

Mode:

Selects to turn On/Off subtitle language.

Subtitle Primary Language

Press the **◀▶** buttons to select your desired subtitle primary language.

Subtitle Secondary Language

Press the **◀▶** buttons to select your desired subtitle secondary language.

Hearing Impaired

Press the **◀▶** buttons to turn On/Off hearing impaired.

3. Press the **EXIT** button to exit the menu.

Teletext

1. Press the **MENU** button to display the main menu. Press the **◀▶** buttons to select **Setup** in the main menu, then press the **▼** or the **OK** button, it will highlight the first option.
2. Press the **▲▼** buttons to select **Teletext** and then press the **OK** button.

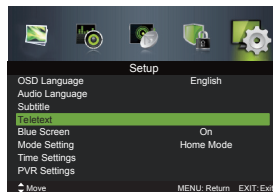

3. Press the **◀▶** buttons to select your desired Digital Teletext Language. Press the **▼** button and then press the **◀▶** buttons to select your desired Decoding Page Language.
4. Press the **EXIT** button to exit the menu.

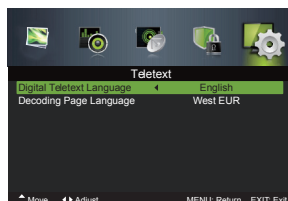

Setup Management

Blue Screen

1. Press the **MENU** button to display the main menu. Press the **◀▶** buttons to select **Setup** in the main menu, then press the **▼** or the **OK** button, it will highlight the first option.
2. Press the **▲▼** buttons to select **Blue Screen** and then press the **◀▶** buttons to select On /Off.

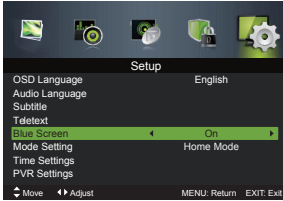

3. Press the **EXIT** button to exit the menu.

Mode Setting

1. Press the **MENU** button to display the main menu. Press the **◀▶** buttons to select **Setup** in the main menu, then press the **▼** or the **OK** button, it will highlight the first option.
2. Press the **▲▼** buttons to select **Mode Setting** and then press the **◀▶** buttons to select your desired mode: Home Mode/Store Mode.
 - Home Mode: Viewing at home.
 - Store Mode: For store demo, the brightness is higher than home mode.

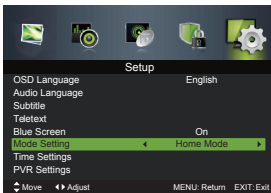

3. Press the **EXIT** button to exit the menu.

Time Settings

1. Press the **MENU** button to display the main menu. Press the **◀▶** buttons to select **Setup** in the main menu, then press the **▼** or the **OK** button, it will highlight the first option.
2. Press the **▲▼** buttons to select **Time Settings** and then press the **OK** button.

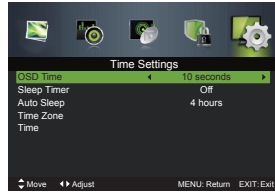

OSD Time

Displays time of the on-screen menu: 10s/20s/30s/60s/Off.

Sleep Timer

Press the **◀▶** buttons to select a period of time after which the TV automatically switches to standby mode: Off/5/15/.../120/240mins.

Auto Sleep

The unit will automatically switch to standby mode 3/4/5 hours after the last time the remote control was used. If you want to operate the TV for a long period of time, turn off the auto standby function.

Time Zone

Selects your desired Time Zone city.



Setup Management

Time

1. The clock is set automatically when receiving a digital signal or you can set it manually.

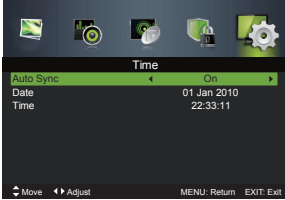

3. Press the EXIT button to exit the menu.

PVR Settings

NOTE: Please make sure the USB device is inserted. If not, a warning message will pop up.

1. Press the MENU button to display the main menu. Press the ◀▶ buttons to select Setup in the main menu, then press the ▼ or the OK button, it will highlight the first option.
2. Press the ▲▼ buttons to select PVR Settings and then press the OK button.



3. Press the ◀▶ buttons to select the following PVR File System options and then press the OK button.

File Manager

Select File Manager to display the recorded programme list, press the ▲▼ buttons to select the recorded programme and then press the OK or ▶▶ button to view.

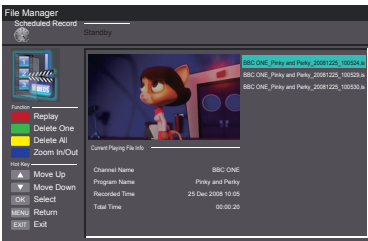

Device List

Select Device List to check the information of the connected USB storage device for PVR. Press the RED button to format the selected USB device.

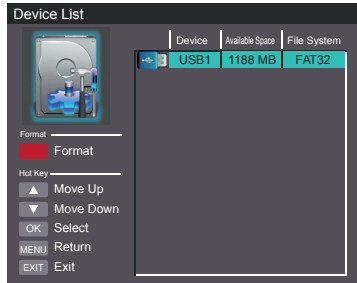

Scheduled Record

Select Scheduled Record to view the scheduled recordings list.

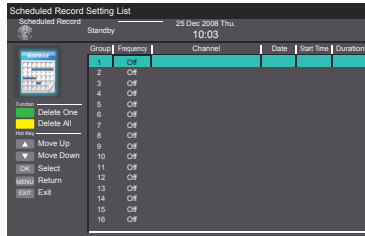

4. Press the EXIT button to exit the menu.

Setup Management

First Time Setup

1. Press the **MENU** button to display the main menu. Press the **◀▶** buttons to select **Setup** in the main menu, then press the **▼** or the **OK** button, it will highlight the first option.
2. Press the **▲▼** buttons to select **First Time Setup** and then press the **OK** button.

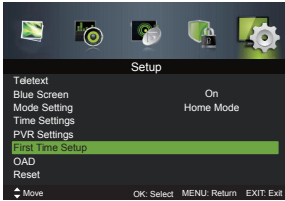

3. Press the **▲▼◀▶** buttons to navigate the menu and change the settings. Then it will search automatically for analogue and digital TV programmes.
4. Press the **EXIT** button to exit the menu.

OAD (Over Air Download)

1. Press the **MENU** button to display the main menu. Press the **◀▶** buttons to select **Setup** in the main menu, then press the **▼** or the **OK** button, it will highlight the first option.
2. Press the **▲▼** buttons to select **OAD** and then press the **OK** button.

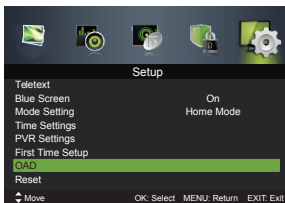

3. Press the **▲▼** buttons to select the over air download type.

Manual OAD Download

The TV auto detects the latest firmware through the DTV signal and allows you to accept or refuse the firmware upgrade service.

Auto Download

The TV auto detects the latest firmware through the DTV signal and upgrades the firmware automatically. Selects to turn On/Off auto OAD download.

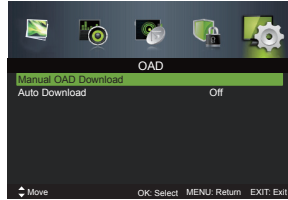

4. Press the **EXIT** button to exit the menu.

Reset

1. Press the **MENU** button to display the main menu. Press the **◀▶** buttons to select **Setup** in the main menu, then press the **▼** or the **OK** button, it will highlight the first option.
2. Press the **▲▼** buttons to select **Reset** and then press the **OK** button.

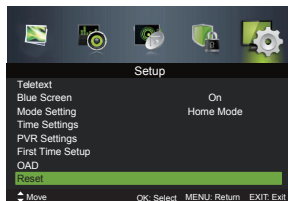

3. Press the **▲▼** buttons to select Yes or No on the screen. All settings will be reset to factory defaults and the Setup menu will disappear.

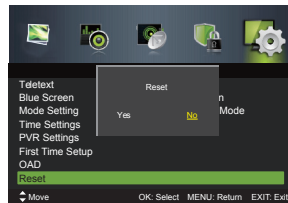

ENTERTAINMENT

Entertainment

Using the Features via USB Port

1. Switch off the TV before connecting any USB storage device.
2. Connect your USB storage device to the USB port of your TV.
3. Press the **⏻** button at the top of the TV or the **⏻** button on the remote control to turn on your TV and your USB storage device.
4. Press the **SOURCE** button at the top of the TV or the **SOURCE** button on the remote control to display the Source List. Use the **▲** **▼** buttons to select USB and then press the **OK** button to confirm.

Attention:

- Some versions of portable hard disk may require more power than the TV USB socket can provide. To ensure correct operation please use power adapter for that device.
- If a USB hub is used make sure its mains adapter is connected to the mains supply as the total current consumption exceed 500mA.
- The maximum supported storage space of the hard disk is 1 TB.
- The file system only support FAT32 format.
- If you want to store the video streaming of a DTV programme, the transfer rate of the USB storage device must not be less than 5MB/s, otherwise the picture and sound of the programme will be affected and a warning statement will be shown on the screen. If this happens, please upgrade your USB storage device.
- The TV screen will be blank temporarily as it will take time to start up and stabilize the connected hard disk. This is normal and the starting time may vary depending on the brand and the memory size of the connected hard disk.
- Disconnect the USB storage device if it is not in use.

Viewing Photo

1. Press the **SOURCE** button at the top of the TV or the **SOURCE** button on the remote control then press the **▲** **▼** buttons to select the USB mode and then press the **OK** button.
2. Press the **◀** **▶** buttons to select **Photo** and then press the **OK** button.

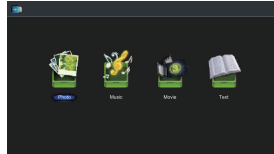

3. Press the **◀** **▶** buttons to select your storage device and then press the **OK** button.

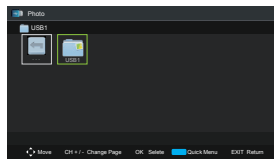

4. Press the **▲** **▼** **▶** **◀** buttons to navigate in the picture folder and then press the **OK** button. If you want to select the specified photos, press the **▲** **▼** **▶** **◀** buttons to select the picture file and then press the **OK** button.

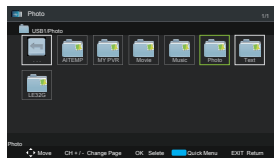
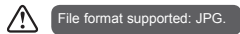

5. Press the **▶** or **OK** button to view.



Entertainment

6. Press the **OK** button or the **DISPLAY** button to display the function bar: Play / Pause / Previous / Next / Rotate Back / Quick Menu (Interval Time / Repeat / Slideshow Effect / Background Music).

 If this folder also contains music files, you can select a music track to play at the same time you view your photos.

7. Press the **EXIT** button to return to the previous menu.

Listening to Music

1. Press the **SOURCE** button at the top of the TV or the **SOURCE** button on the remote control then press the **▲▼** buttons to select the USB mode and then press the **OK** button.
2. Press the **◀▶** buttons to select **Music** and then press the **OK** button.

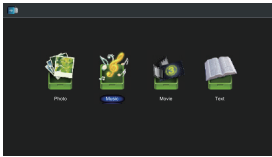

3. Press the **▲▼** buttons to select your storage device and then press the **OK** button.

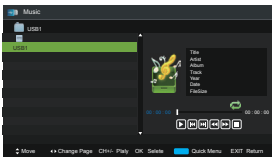

4. Press the **▲▼** buttons to navigate in the music folder and then press the **OK** button. If you want to select the specified music, press the **▲▼** buttons to select the music file and then press the **OK** button.

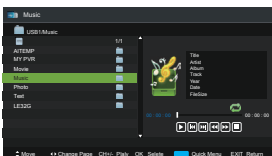

 Some audio file formats will not be supported. Supported File format: MP3.

5. Press the **▶||** or **OK** button to start to play.

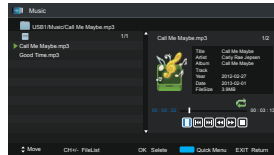

6. Press the **◀▶** buttons and then press the **OK** button to select the function: Play / Previous / Next / FB / FF / Stop / Quick Menu (Repeat / Background Music).
7. Press the **EXIT** button to return to the previous menu.

Viewing Movies

1. Press the **SOURCE** button at the top of the TV or the **SOURCE** button on the remote control then press the **▲▼** buttons to select the USB mode and then press the **OK** button.
2. Press the **◀▶** buttons to select **Movie** and then press the **OK** button.

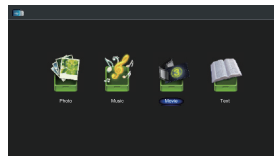

3. Press the **▲▼** buttons to select your storage device and then press the **OK** button.

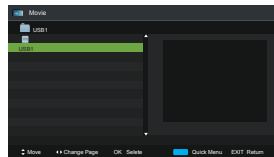

4. Press the **▲▼** buttons to navigate in the movie folder and then press the **OK** button. If you want to select the specified movie, press the **▲▼** buttons to select the movie file and then press the **OK** button.

 Some audio file formats will not be supported. Supported File format: MPEG 1/2.

Entertainment

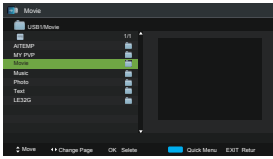

5. Press the **▶||** or **OK** button to view.

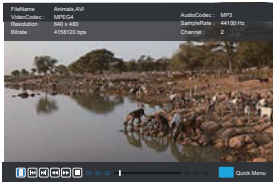

6. Press the **OK** button or the **DISPLAY** button to display the function bar. Press the **◀▶** buttons and then press the **OK** button to select the function: Pause / Previous / Next / FB / FF / Stop / Quick Menu (Repeat / Encode Type).

7. Press the **EXIT** button to return to the previous menu.

My Text

1. Press the **SOURCE** button at the top of the TV or the **SOURCE** button on the remote control then press the **▲▼** buttons to select the USB mode and then press the **OK** button.
2. Press the **◀▶** buttons to select **Text** and then press the **OK** button.

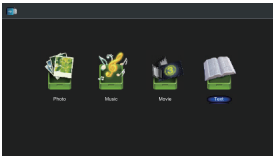

3. Press the **◀▶** buttons to select your storage device and then press the **OK** button.

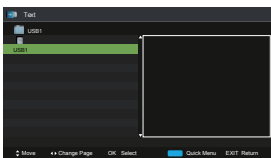

4. Press the **▲▼** buttons to navigate in the text folder and then press the **OK** button. If you want to select the specified text file, press the **▲▼** buttons to select the text file and then press the **OK** button.

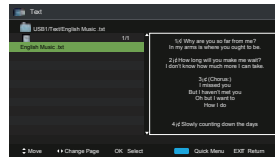
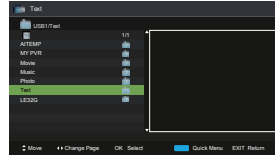

5. Press the **◀▶** or **OK** button to view.

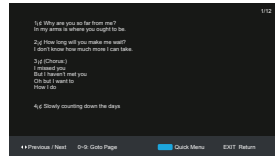

6. Press the **OK** button or the **DISPLAY** button to display the function bar. Press the **▲▼** buttons and then press the **OK** button to select the function: Previous / Next / Goto Page / Quick Menu (Repeat / Background Music / Encode Type).



If this folder also contains music files, you can select a music track to play at the same time you view your texts.

7. Press the **EXIT** button to return to the previous menu.

Using the DVD Features

Using the Built-in DVD Player

1. Insert a disc with the content side facing towards your TV. (CD-R, CD-RW, DVD-R, DVD-RW, CD, DVD+R, or DVD+RW) Allow 10 seconds for the player to load the disc. If you insert the disc wrongly, an error message will be displayed.

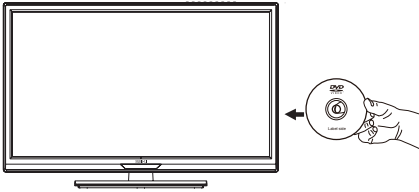

2. After the disc is inserted, the TV will change the input source to DVD automatically and Smart NAVI will show the content of the disc automatically.
3. If the DVD player does not automatically play the disc, press the SOURCE button at the rear right of the TV or the SOURCE button on the remote control to display the Source List. Use the ▲▼ buttons to select DVD and then press the OK button to confirm. Press the ► button on the unit or the ► button on the remote control to start playing.

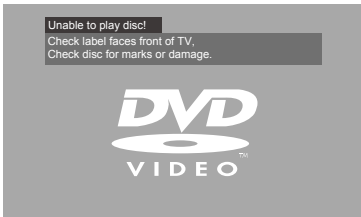

4. Press the ▲ button if you want to remove the disc.



- Only insert 12cm discs. Do not insert or play 8cm discs; they will get stuck.
- Ensure disc is fully ejected before removing it, or else you risk damaging the DVD player.

Notes on DVD playback

Disc Types	Disc LogoR	Recorded Content
DVD-VIDEO (Digital Versatile Disc)		AUDIO + VIDEO
DVD±RW (Audio/Video format or JPEG files)		AUDIO + VIDEO + JPEG
DVD±R (DVD Recordable - Audio/Video format or JPEG files)		AUDIO + VIDEO + JPEG
CD-R (CD Recordable - Audio/Video format or JPEG files)		AUDIO + VIDEO + JPEG
CD-RW (CD-Rewritable - Audio/Video format or JPEG files)		AUDIO + VIDEO + JPEG
AUDIO-CD (Compact Disc Digital Audio)		AUDIO

Supported Formats

JPEG

- The file extensions has to be .jpg and not jpeg.
- Pictures encoding must comply with JPEG/ISO format.
- This DVD player can only display DCF standard still pictures or JPEG pictures such as TIFF.

Region Code

Both the DVD player and the discs are coded by region. These regional codes must match in order to play the disc. If the codes do not match, the disc will not play.

The Region Number for this DVD player is described on the rear panel of the TV.

Disc Types	DVD-VIDEO
Region code	

Using the DVD Features

Basic DVD Playback Functions

Playing the DVD

Depending on the disc, a menu may appear on the TV screen once the disc has loaded. When playing the disc, you may use the **▶||** button to toggle between Play and Pause mode. This product also supports Menu / Title / Sequential / Programme Playback.

Menu Playback (for DVD)

- For DVD discs, the screen will display the DVD Disc Menu (Root Menu).
- Press the **▶||** button or the OK button to start from the highlighted content.
- Press the DVD MENU/SUBPAGE button to return to the Root Menu when playing the disc.
- For some DVD discs you may need to press the DVD MENU /SUBPAGE button or the TITLE button to display the Disc Menu.
- Press the **■** button once to stop. Press the **▶||** button to resume from where you stopped.
- Press the button twice to stop. Press **▶||** the button to start from the beginning.
- In order to protect the disc, press the **■** button twice and then press the **▲** button to eject the disc. When the disc is ejected, hold the disc edge slightly and remove it from the disc slot.
- When not using the DVD function (in standby mode or using others modes for a long period of time), please take out the disc to protect the DVD loader and the disc.

Previous / Next (for DVD / CD / Multimedia discs)

- Press the **◀◀** button to play the last Title / Chapter / Track.
- Press the **▶▶** button to play the next Title / Chapter / Track.

If the current track is the first one, pressing the **◀◀** button will restart the disc from the beginning.

If the current track is the last one, pressing the **▶▶** button will stop the playback.

- For DVD discs, the above functions may vary due to different DVD disc's structure.

Forward / Backward (for DVD / CD / Multimedia discs)

- There are 4 speeds for forward. Press the button to toggle between the different

forward options in sequence. (FORWARD x 2 / FORWARD x 4 / FORWARD x 8 / FORWARD x 16 / FORWARD x 32 / Play).

- Press the **▶||** button to return to normal speed playback.
- For DVD discs, when selecting backward to first title / chapter, the disc will start from the beginning.



There will be no sound during forward or backward.

Pause (for DVD / CD / Multimedia discs)

- For CD / JPEG discs, press the **▶||** button to pause; press the **▶||** button again to resume playback.
- For DVD discs, press the button to pause; press the button again to resume playback.

Repeat (for DVD / CD / Multimedia discs)

Press the REPEAT button once to display the current repeat mode.

- For CD discs, while playing in sequence, you may use the repeat playback. There are 4 repeat modes, press the REPEAT button to toggle between the different repeat modes in sequence. (Repeat Off / Repeat One / All / Single).

Repeat

- For DVD discs, you may setup the repeat playback mode. There are 4 repeat modes, press the REPEAT button to toggle between the different repeat modes in sequence. (Repeat: Off / Repeat: Chapter / Repeat: Title/ Repeat:All).

Info (for DVD / CD / Multimedia discs)

Press the DISPLAY button to activate the on screen roll-down menu for the current Title, Chapter, Time and other information.

For DVD discs, press the button once to display the first page as shown below:

- For DVD discs, press the DISPLAY button once to display the first page as shown below:

Title Elapsed
TT: 01/08 CH:01/01
0:00:09

Using the DVD Features

Basic DVD Playback Functions

- Press the **DISPLAY** button twice to display the second page as shown below:

Title Remain

TT: 01/08 CH:01/01

0:04:47

- Press the **DISPLAY** button three times to display the three page as shown below:

Chapter Elapsed

TT: 01/08 CH:01/01

0:00:16

- Press the **DISPLAY** button four times to display the four page as shown below:

Chapter Remain

TT: 01/08 CH:01/01

0:04:41

- Press the **DISPLAY** button five times to display the four page as shown below:

Display off

Aspect

Allows you to select the video size of programme stream.

- Press the Aspect button to select the size you want.

Notes on DVD playback

Goto (for DVD / CD / Multimedia discs)

This function allows you to play your favourite Title / Chapter / Time. Press the GOTO button to activate the on screen scroll-down menu for selecting. Input your Title / Chapter / Time by pressing the 0-9 buttons or input the playback time. After editing, press the OK button to start. If the input is invalid, it will not function.



For some discs, only **Time** can be selected in the **GOTO** function

Audio (for DVD / CD)

Press the AUDIO button to toggle between different audio modes in sequence.

- For CD discs: Mono Left/Mono Right/Mix-Monno /Stereo



Some discs may contain multiple languages which can be selected by pressing the AUDIO button.

A-B (for DVD / CD)

When playing DVD, CD disc, press the A-B button to repeat certain content. Press the A-B button on the start point (A) and the end point (B) to select the repeat part. Press the A-B button a third time to cancel the A-B button function and return to normal playback.

Using the DVD Features

Playing Multimedia Discs

After loading the multimedia disc, the disc/contents will automatically be displayed and= sorted by different file formats into Music / Picture / Video / folders..

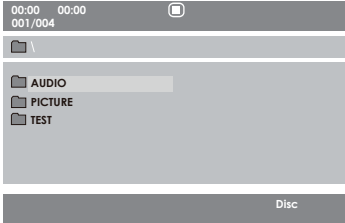

1. Press the **▲◀▶▼** buttons to navigate through the folders and files.
2. Press the **0-9** buttons to select the contents directly
3. When playing or pausing with picture playback, you may use **▲◀▶▼** the buttons to flip / rotate the picture.

Using the DVD Language Setup Page

In the DVD mode, press the **SETUP** button on the remote control. Press **▲▼** the buttons to select the Language Setup menu, and then press the **◀▶** buttons to select the menu options. Press the Setup button to exit the menu.



In Setup mode, the disc playback function will not be available.

OSD

Set the OSD language to your language of choice.



Using the DVD Language Setup Page

Menu

DISC MENU: Select the Disc Menu language.



The default language is English.

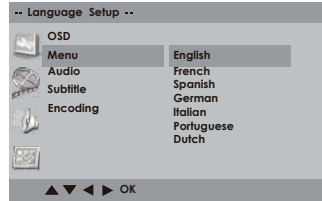

Audio

Set the Audio language to your language of choice.



Not all DVD discs support multiple audio languages.



Subtitle

Select the Subtitle language.



Not all DVD discs support multiple audio languages.



Using the DVD Features

Basic DVD Playback Functions

Encoding

Select the encoding of subtitle Western European or Central European.

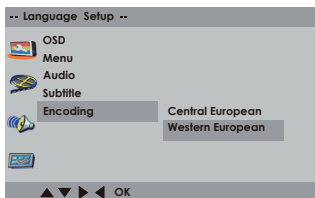

- 16:9
Widescreen picture shown in the full screen.

Using the DVD Screen Setup Page

In the DVD mode, press the **SETUP** button on the remote control. Press the **▲▼** buttons to select the Screen Setup menu, and then press the **◀▶** buttons to select the menu options. Press the Setup button to exit the menu.



In Setup mode, the disc playback function will not be available.

TV Display

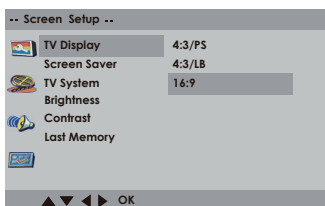

- 4:3 Pan Scan
Widescreen picture shown in the full screen with some part cut.



- 4:3 Letter box
Widescreen picture shown in the full screen with black bars on the top and bottom of the screen.



Screen Saver

When the player stops or the picture becomes motionless for a couple of minutes, there will a screen saver to prevent damage to the display screen.

- ON: To activate screen saver.
- OFF: To disable screen saver.

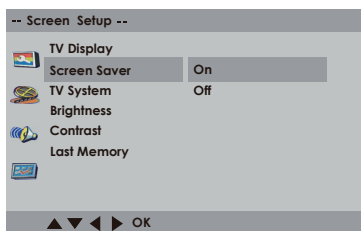

TV System

In order for the disc to play, the colour system of the DVD player, disc and TV should match.

- NTSC
This format is used by some other countries, e.g. USA.
- PAL
This is the format used in UK.
- AUTO
This format can be used if your TV / DVD is capable of both PAL and NTSC formats and this is the default setting.

Using the DVD Features

Using the DVD Screen Setup Page



PAL format is generally used for TV's in the UK. If NTSC is selected with a non-compatible television, you may experience interference or picture scrolling.

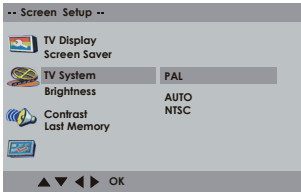

Brightness

Select the Brightness of screen in DVD mode.

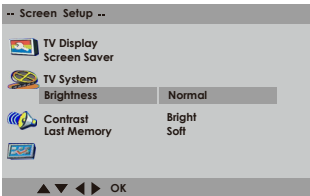

Contrast

Select the Contrast of screen in DVD mode.



Last Memory

- On: Continue playing from last stop every time.
- Off: Close the memory function and play from DVD start every time

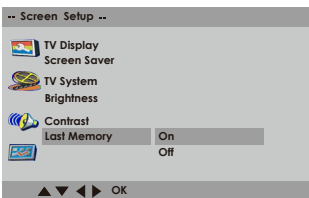

Using the DVD Language Setup Page

In the DVD mode, press the **SETUP** button on the remote control. Press the **▲▼** buttons to select the **Audio Setup** menu, and then press the **◀▶** buttons to select the menu options. Press the **Setup** button to exit the menu.



In Setup mode, the disc playback function will not be available.

Downmix

- Lo/Ro: Mixed stereo surround output.
- Lt/Rt: Mixed stereo Lt/Rt output.



Using the DVD Custom Setup Page

In the DVD mode, press the **SETUP** button on the remote control. Press the **▲▼** buttons to select the **Custom Setup** menu, and then press the **◀▶** buttons to select the menu options. Press the **Setup** button to exit the menu.



In Setup mode, the disc playback function will not be available.

PARENTAL CTRL

Allows the user to set a maximum rating level for a movie that can be played (e.g. PG rating). Movies rated higher than the level set will not be played. The parental lock can only be changed after inputting the correct password.



This function is available only when the discs have ratings encoded on them.

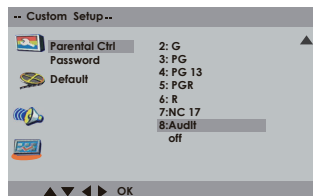

Using the DVD Features

Using the DVD Custom Setup Page

Password

To change the password, you need to:
Press OK once, Change turns green and press
once again enter setup.

1. Input old password. (for initial use, please enter factory default password "8899")
2. Input a new 4 digit password and then press the OK button to



If you forget your DVD password, please enter the master password "8899".

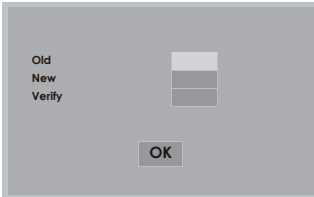
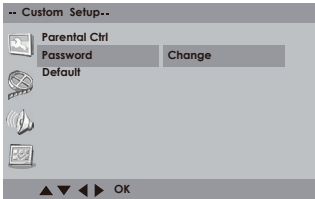

Default

To restore all setup parameters to the factory settings **EXCEPT** the password.
This function is available in stop state or when the tray is opened.

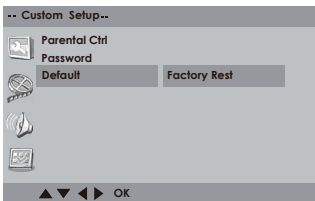

PARENTAL CONTROL

Press the **MENU** button on the unit or the remote control and then press ◀ / ▶ buttons to select LOCK menu. LOCK menu. Use the **0-9** buttons to input the 4-digit passwords to enter the **LOCK** menu. If used, this option feature can “block” undesirable programming from appearing on the TV.

Parental Control offers the user a wide variety of options and settings that restrict or “block” the programming that can appear on the TV. Parental Control allows the user to define which program rating the consider acceptable for the younger more sensitive viewer. It can be preset and turned either on or off by the the user who specifies the secret 4-number password. Geberal audiences and children blocks shoud be both programmed into the the TV'S memory. Separate different viewer ratings are specified for both TV and the motion prcture Industry; both rating systems should be used and based on the ages if children.

Key Lock:

If the key locked is set on, all buttons on the TV will be locked. All TV operations can be controlled by the remote control only. Press the ◀ / ▶ buttons to select On or Off.

Notice:

The default password is “0000”. If you change the password, be sure to remember the new password! If you forget your password, press the master password “8899” on the remote control.

DIGITAL RECEPTION

MHEG-5 ENGINE compliant with ISO/IEC 13522-5 UK engine Profile 1 - for UK
Object carousel support compliant with ISO/IEC 135818-6 and UK DTT profile - for UK
Frequency range: 474-850 MHz for UK models
170-862 MHz for EU models
Transmission standard: DVB-T. MPEG-2
Demodulation: COFDM with 2K/8K FFT mode
FEC: all DVB modes
Video: MP@ML, PAL, 4:3/16:9
Audio: MPEG Layer I&II 32/44.148kHz.

We apologise for any inconvenience caused by any minor inconsistencies in these instructions, which may occur as a result of product improvements and development.

SUPPORTED FILE FORMATS

Media	File Extension	Format		Supported (Maximum resolution/Bit rate etc.)
		Video	Audio	
Movie	.mpg/.dat/.vob	MPEG-1	MPEG-1 Layer 2/3	
		MPEG-2	MPEG-2 Layer3	
Music	.mp3	-	MPEG-1 Layer3 MPEG-2 Layer3	Bit Rate: up to 320Kbps Sample Rate: 32KHz, 44.1KHz, 48KHz
Photo	.jpg	Baseline Mode		72x72<Baseline resolution<7680x4320 Progressive Mode Size<=1280x1024 File Size<=10MB
		Progressive Mode		

TROUBLESHOOTING

If your TV does not operate normally or cannot be turned on, please check the following troubleshooting questions. Remember also to check any other connected electronic device, such as DVD or Blu-ray player to pinpoint the problem. If the TV still fails to operate normally, please contact technical support.

The TV does not operate properly

The TV does not respond when pressing any buttons	<ul style="list-style-type: none"> The TV may freeze up during use. Disconnect the power cord from the power socket for a few minutes. Reconnect the power cord and try to operate it again as usual.
TV cannot be switched on	<ul style="list-style-type: none"> Check that the TV is connected to the power supply. Make sure all connected AV devices are switched off before switching on your TV.
The remote control does not work	<ul style="list-style-type: none"> Check to see if there are any objects between the TV and the remote control causing an obstruction. Ensure that you are pointing the remote control directly at the TV. Ensure that the batteries are installed with the correct polarity (+ to +, - to -). Install new batteries.
Power is suddenly turned off	<ul style="list-style-type: none"> Check the power of the TV. The power supply maybe interrupted. Check if the sleep timer is set. Check whether the Auto Standby is activated.

The video function does not work

No picture & No Sound	<ul style="list-style-type: none"> Check whether the TV is switched on. Try another channel. The problem may be caused by the broadcaster.
Picture appears slowly after switching on	<ul style="list-style-type: none"> This is normal; the image is muted during the TV startup process. Please contact your service centre if the picture has not appeared after five minutes.
No or poor colour or poor picture	<ul style="list-style-type: none"> Adjust the settings in the PICTURE menu. Try another channel. The problem may be caused by the broadcaster. Check if video cables are connected properly.
Horizontal/Vertical bar or picture shaking	<ul style="list-style-type: none"> Check for local interference such as an electrical appliance or power tool.
Poor reception on some channels	<ul style="list-style-type: none"> The station or cable channel may be experiencing problems; tune to another station. Station signal may be weak, reposition the antenna for better reception. Check for sources of possible interference.
Lines or streaks in pictures	<ul style="list-style-type: none"> Check antenna (change the position of the antenna.)
No pictures when connecting HDMI	<ul style="list-style-type: none"> Check if the input source is HDMI.
Pictures appear in wrong ratio	<ul style="list-style-type: none"> Adjust the Aspect Ratio settings in the SETUP menu or press the ASPECT button on the remote control.

The audio function does not work

Picture OK but no sound	<ul style="list-style-type: none"> • Press the VOL +/- buttons. • Sound muted? Press the MUTE button. • Try another channel. The problem may be caused by the broadcaster.
No output from one of the speakers	<ul style="list-style-type: none"> • Adjust the Balance settings in the AUDIO menu.
Unusual sound from inside the TV	<ul style="list-style-type: none"> • A change in ambient humidity or temperature may result in an unusual noise when the TV is switched on or off and does not indicate a fault with the TV.
No sound when connecting HDMI	<ul style="list-style-type: none"> • Check if the input source is HDMI.
Audio noise	<ul style="list-style-type: none"> • Keep the RF coaxial cable away from the other connected cables.

Password

Lost password	<ul style="list-style-type: none"> • Select the SET Password setting in the LOCK menu, then enter the following master password "8899". The master password clears your previous password and allows you to enter a new password.
---------------	--

There is a problem in PC mode

The signal is out of range (invalid format)	<ul style="list-style-type: none"> • Adjust the resolution, horizontal frequency, or vertical frequency.
Vertical bar or stripe on background and Horizontal Noise and Incorrect position	<ul style="list-style-type: none"> • Use Auto configures or adjust clock, phase, or H/V position.
Screen colour is unstable or show a single colour	<ul style="list-style-type: none"> • Check the signal cable. • Reinstall the PC video card.

Plug replacement - UK and Ireland only

Should you need to replace the plug; the wires in the power cable are coloured in the following way:

Blue – Neutral 'N'

Brown – Live 'L'

As the colours of the wires in the power cable may not correspond with the coloured markings identifying the terminals in your plug, and proceed as follows:

The blue wire must be connected to the terminal that is marked with the letter N.

The brown wire must be connected to the terminal that is marked with the letter L.

If the power lead is damaged, it must be replaced by a qualified electrician.

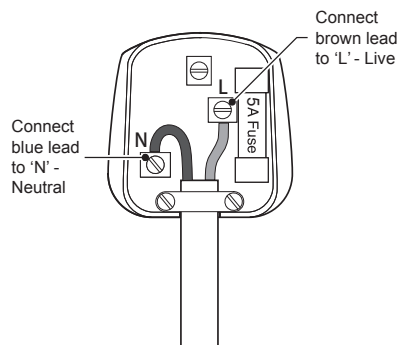

SPECIFICATION

Panel Size	23.5 inch diagonally
Display Type	LED
Panel Technology	TFT
Panel 60 Hz Vs. 120 Hz	60 Hz
Display Resolution	1080P
Panel Resolution	1920 x 1080
Aspect Ratio	16:9
Dynamic Contrast Ratio-Panel	5000:1
Brightness (Centre Typ.) Cd/M ²	100~150
Response Time (G To G)	4 ms
Lamp Life (Typ. Hours)	30,000 hours
Horizontal Viewing Angle (At CR>10)	176
Vertical Viewing Angle (At CR>10)	176
Wall-mount(LxW-mm)	100*100(mm)

DISPOSAL INFORMATION

Instructions for waste disposal:

Packaging and packaging aids are recyclable and should principally be recycled. Packaging materials, such as foil bag, must be kept away from children.

The cold cathode fluorescent lamp in LCD PANEL contains a small amount of mercury; please follow the local laws or regulations for disposal.

Information for Users on Disposal of old Equipment and Batteries (European Union only)

These symbols indicate that equipment with these symbols should not be disposed of as general household waste. If you want to dispose of the product or battery, please consider the collection systems or facilities for appropriate recycling.

Notice: The sign Pb below the symbol for batteries indicates that this battery contains lead.

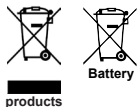

Information for Users in European Union Countries

This symbol on the product or on its packaging means that your electrical and electronic device should be disposed of at the end of its service life separately from your household wastes. There are separate collection systems for recycling in EU.

For more information, please contact the local authority or the dealer where you purchased the product.



SEIKI LED TV's LIMITED WARRANTY TO ORIGINAL CONSUMER

52 inches and Under Screen Size Models (the "Product")

This Product (including any accessories included in the original packaging) as supplied and distributed in new condition, is warranted by Tongfang Global(UK) Co. Ltd (SEIKI) to the original consumer purchaser against defects in material and workmanship ("Warranty") as follows:

- 1. REPLACEMENT** : For a period of one (1) year from date of original consumer purchase, if this Product or any part is determined by SEIKI, or a SEIKI authorized service provider, to be defective, SEIKI will replace the Product with new or re-certified product of similar or better specification, at SEIKI's option, at no charge to the original consumer. After the one (1) year Warranty period, you must pay for all cost of Product replacement charges.
- 2. PARTS** : For a period of one (1) year from the date of original consumer purchase, SEIKI will supply, at no charge to the original consumer, new, rebuilt or refurbished replacement parts in exchange for defective parts. After the one (1) year Warranty period, you must pay for the costs of all parts.
- 3. SHIPPING COSTS** : Notwithstanding the foregoing, the original consumer is responsible for any shipping charges incurred to ship the Product or part(s) to SEIKI or to an SEIKI authorized customer service provider, for diagnosis, repair or replacement. The consumer is responsible for securely packing the Product and utilizing a reliable carrier to transport to SEIKI authorized service provider.

To obtain Warranty Service and Troubleshooting information call our toll free customer service line at:

0-845-658-8290

Please have your model and serial number available along with your date of purchase.

You can also visit us online and REGISTER your SEIKI product at:

www.SEIKI.com/UK

To receive Warranty service, the original consumer purchaser must contact SEIKI for problem determination and service procedures. **Proof of purchase in the form of a bill of sale or receipted invoice, evidencing that the Product is within the applicable Warranty period(s), MUST be presented to SEIKI, or an authorized customer service provider, in order to obtain the requested service.**

Exclusions and Limitations

This Warranty covers manufacturing defects in materials and workmanship encountered in the normal, non-commercial use of the Product, and does not cover (a) damage or failure caused by or attributable to abuse, misuse, failure to follow instructions, improper installation or maintenance, alteration, accident, or excess voltage or current; (b) improper or incorrectly performed repairs by non-authorized service facilities; (c) onsite consumer instruction or adjustments; (d) transportation, shipping, delivery, insurance, installation or set-up costs; (e) costs of product removal, transportation or reinstallation costs; (f) ordinary wear and tear, cosmetic damage or damage due to acts of nature, accident; (g) commercial use of the Product; (h) modification of, or to any part of the Product. In addition, this Warranty does not cover images "burnt" into the screen. This Warranty applies to the original consumer only and does not cover products sold AS IS or WITH ALL FAULTS, or consumables (e.g., fuses, batteries, bulbs etc.), and the Warranty is invalid if the factory-applied serial number has been altered or removed from the Product. This Warranty is valid only in the United States and Canada, and only applies to products purchased and serviced in the United States and Canada. All replaced parts and products, and products on which a refund is made, become the property of the Warrantor.

NO WARRANTIES, WHETHER EXPRESS OR IMPLIED, INCLUDING, BUT NOT LIMITED TO, ANY IMPLIED WARRANTIES OF MERCHANTABILITY OR FITNESS FOR A PARTICULAR PURPOSE, OTHER THAN THOSE EXPRESSLY DESCRIBED ABOVE SHALL APPLY. THE WARRANTOR FURTHER DISCLAIMS ALL WARRANTIES AFTER THE EXPRESS WARRANTY PERIOD STATED ABOVE. NO OTHER EXPRESS WARRANTY OR GUARANTY GIVEN BY ANY PERSON, FIRM OR ENTITY WITH RESPECT TO THE PRODUCT SHALL BE BINDING ON THE WARRANTOR. REPAIR, REPLACEMENT, OR REFUND OF THE ORIGINAL PURCHASE PRICE - AT THE WARRANTOR'S SOLE DISCRETION - ARE THE EXCLUSIVE REMEDIES OF THE CONSUMER. THE WARRANTOR SHALL NOT BE LIABLE FOR ANY INCIDENTAL OR CONSEQUENTIAL DAMAGES CAUSED BY THE USE, MISUSE OR INABILITY TO USE THE PRODUCT. NOTWITHSTANDING THE FOREGOING, CONSUMER'S RECOVERY SHALL NOT EXCEED THE PURCHASE PRICE OF THE PRODUCT SOLD BY SEIKI. THIS WARRANTY SHALL NOT EXTEND TO ANYONE OTHER THAN THE ORIGINAL CONSUMER WHO PURCHASED THE PRODUCT AND IS NOT TRANSFERABLE.

Some states do not allow the exclusion or limitation of incidental or consequential damages, or allow limitations on warranties, so the above limitations or exclusions may not apply to you. This Warranty gives you specific rights, and you may have other rights, which vary from state to state.

DO NOT SHIP PRODUCT TO THIS ADDRESS. PLEASE CONTACT CUSTOMER SERVICE TO OBTAIN SHIPPING ADDRESSES FOR SERVICE.