

ROBERTS

Sound for Generations

MP-SOUND 43

CD/DAB/FM Digital Sound System with dock for iPod



DAB

Digital Audio Broadcasting

Please read this manual before use

iPod is a trademark of Apple Inc., registered in the U.S. and other countries.

"Made for iPod" means that an electrical accessory has been designed to connect specifically to iPod and has been certified by the developer to meet Apple performance standards.

Apple is not responsible for the operation of the device or its compliance with safety and regulatory standards.

Contents

<i>About this instruction manual</i>	2	<i>CD track programming</i>	27
Introduction	3	<i>MP3 / WMA CD mode</i>	28
<i>MP-43 Sound System features</i>	3	<i>MP3 / WMA file and folder selection</i>	29-30
<i>Controls and connections</i>	4-5	iPod Docking	31
<i>Remote control</i>	6-7	<i>Navigating your iPod</i>	32
<i>Using the touch panel</i>	8	<i>Playing a file on your iPod</i>	32-33
<i>Remote control functions</i>	8	Clock and Alarms	34
<i>Display icons</i>	8	<i>Alarms</i>	34-35
<i>Using the sound system for the first time</i>	9	<i>Cancelling alarms</i>	36
DAB radio	10	<i>Snooze</i>	36
<i>Operating your sound system - DAB</i>	10	<i>Sleep function</i>	36
<i>Selecting a station - DAB</i>	11	<i>Setting the clock manually</i>	37-38
<i>Secondary services - DAB</i>	11	<i>Standby brightness control</i>	39
<i>Display modes - DAB</i>	12-13	Audio and Setup	40
<i>Finding new stations - DAB</i>	13	<i>Equaliser function</i>	40
<i>Manual tuning - DAB</i>	14	<i>Bass and treble settings</i>	40-41
<i>Station order setup - DAB</i>	15-16	<i>Mute function</i>	41
<i>Software version - DAB</i>	17	<i>Auxiliary input socket</i>	42
<i>Dynamic range control - DAB</i>	18	<i>Line output socket</i>	42
FM radio	19	<i>Headphone socket</i>	43
<i>Operating your radio - search tuning FM</i>	19	<i>Aerial removal</i>	43
<i>Manual tuning - FM</i>	20	<i>Touch panel sensitivity control</i>	44
<i>FM stereo / mono</i>	20	<i>System reset</i>	45
<i>Display modes - FM</i>	21	Information	46
<i>Presetting stations</i>	22	<i>Cautions</i>	46
CD / MP3 / WMA	23	<i>Specifications</i>	46
<i>Compact discs</i>	23	<i>Mains supply</i>	47
<i>Playing a CD</i>	24-25	<i>Guarantee</i>	49
<i>CD search and repeat</i>	26		

About this instruction manual

This instruction manual is split into sections for each of the different operating modes of your Roberts MP-43 Digital Sound System. The introduction describes the features and controls of the product.

There are six sections covering the main features in detail - DAB radio, FM radio, CD / MP3 / WMA playback, iPod docking, Clock and Alarm, and Audio and Setup. Each section is clearly identified by the shaded heading in the top right hand corner of each pair of pages.

The two sections for **DAB Radio** and **FM Radio** describe how to use the sound system to listen to radio broadcasts.

The section for **CD / MP3 / WMA player** describes how to play digital audio CDs or MP3 / WMA files which have previously been recorded to CD-R or CD-RW.

The section for **iPod docking** describes how to use your MP-43 to play audio files or video soundtracks directly from your iPod.

The section titled **Clock and Alarms** describes setting the clock, as well as explaining the use of the alarms, snooze and sleep timer features.

The **Audio and Setup** section describes how to use the audio equaliser and tone controls, how to connect other audio equipment, how to adjust the sensitivity of the touch panel and how to reset the sound system.

Lastly, the **Information** section includes safety, specifications and warranty information.

Introduction

(page 3)

DAB Radio

(page 10)

FM Radio

(page 19)

CD / MP3 / WMA

(page 23)

iPod Docking

(page 31)

Clock and Alarms

(page 34)

Audio and Setup

(page 40)

Information

(page 46)

MP-43 Sound System features

The Roberts MP-43 Digital Sound System provides the following range of features in an attractive compact unit:-

- Radio for DAB and FM (with RDS) broadcasts.
- Audio CD player with track search and programming facility (can also play CD-R, CD-RW discs).
- Playback of MP3 and WMA files which have been recorded to CD-R or CD-RW.
- 20 radio station presets (10 for DAB and 10 for FM).
- iPod docking connector to play your music collection or video soundtracks from your iPod.
- Easy to use, wipe clean, touch sensitive control panel.
- Clock display with time and date when in standby.
- Two alarm timers with snooze feature to wake you to either buzzer, radio, CD or iPod (with humane wake system on buzzer alarm).
- Adjustable sleep timer which can be set to turn the sound system off after between 15 and 120 minutes.
- Easy-to-read 2 line text display with large clock display.
- A 3.5mm stereo Auxiliary Input socket for playing audio from MP3 players, iPod devices which cannot use the dock connector, or other audio equipment.
- A standard 3.5mm Line Output socket for connecting the audio signal to an external amplifier or recorder.
- A standard 3.5mm headphone socket for private listening.
- High quality, full range, stereo speakers (2 x 7W).
- An acoustically tuned, hand finished cabinet that includes bass ports and internal bracing for optimal sound reproduction.
- Low power consumption when in standby mode.

Controls and connections

(Front)

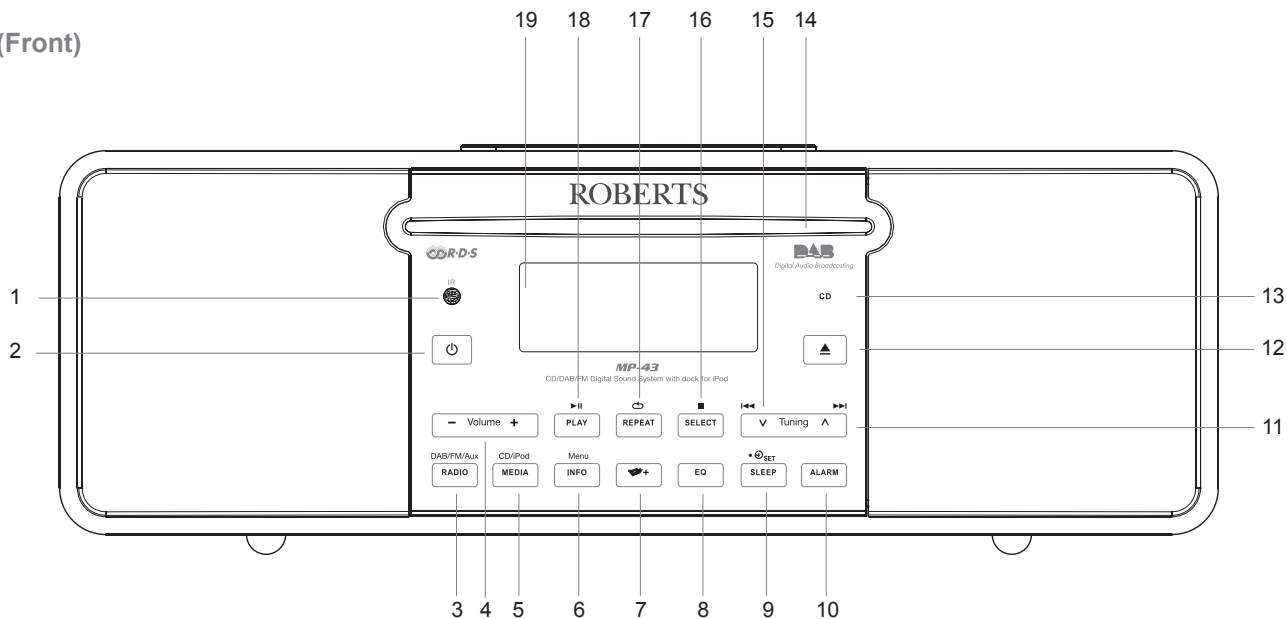

1. Infra-red sensor
2. On / Standby button
3. Radio button
4. Volume Up and Down buttons
5. Media button
6. Info / Menu button
7. Folder button

8. Equaliser button
9. Sleep / Clock set button
10. Alarm button
11. Tuning Up / Fast-forward button
12. CD eject button
13. CD in indicator
14. CD slot

15. Tuning down / Rewind button
16. Select / Stop button
17. Repeat button
18. Play / Pause button
19. LCD display

(Rear)

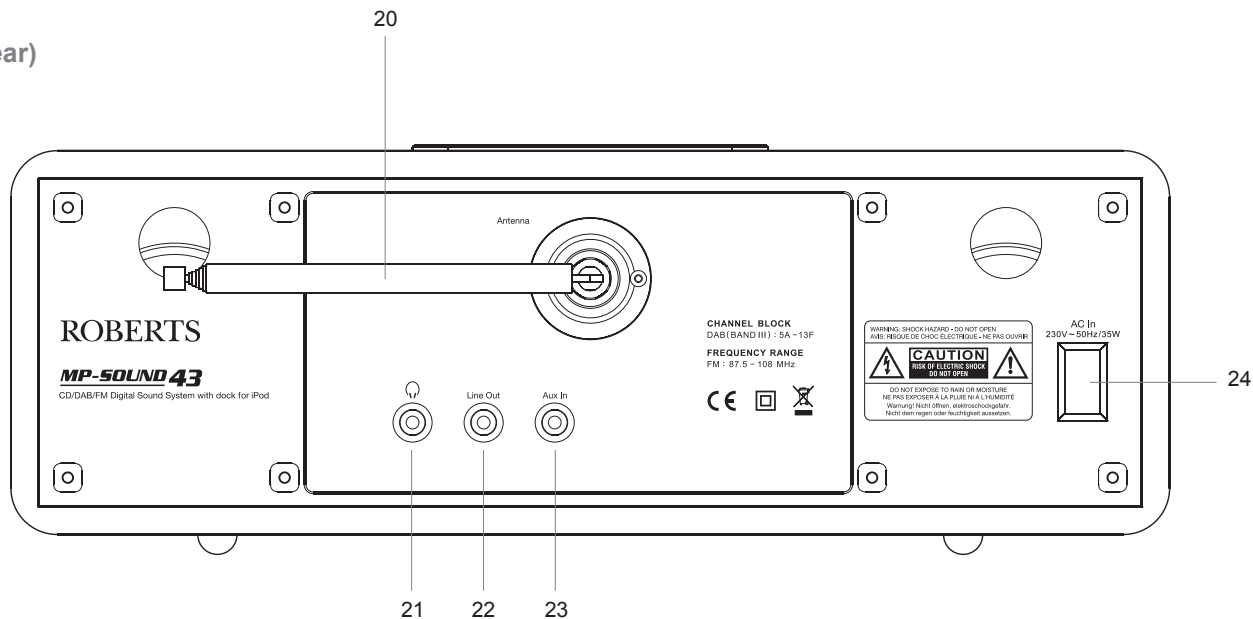

- 20. Telescopic aerial
- 21. Headphone socket
- 22. Line output socket

- 23. Auxiliary input socket
- 24. Mains input socket

Remote control

1. On / Standby button
2. Mute button
3. Key pad buttons 1-10/0
4. Folder Up button
5. Tuning Down / Rewind button
6. Menu button
7. Repeat button
8. Media button
9. Sleep / Clock set button
10. Equaliser button
11. Alarm button
12. Radio button
13. Auto-tune button
14. Random button
15. Play / Pause button
16. Folder down button
17. Tuning / Fast-forward button
18. Select / Stop button
19. Info button
20. Volume Up / Down buttons
21. CD eject button

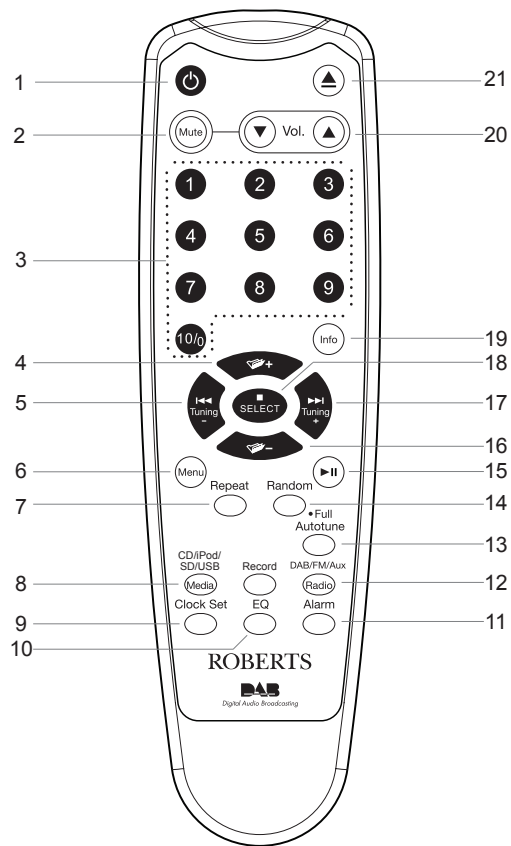

Note:

The button marked Record is not used with the MP-43. It is intended for use with another Roberts product.

Button 8, marked CD/iPod/SD/USB, only provides access to CD and iPod functionality. The SD/USB markings are for another Roberts product.

Remote control battery replacement

1. Remove the battery cover on the rear of your remote control by applying pressure to the catch in the direction shown by the arrow in the diagram, and then lifting the cover.
2. Insert 2 x AAA size batteries into the compartment. Make sure the (+) and the (-) ends of the batteries are positioned as shown inside the compartment.
3. Close the battery cover by inserting the retaining lugs first, then apply pressure to the free end such that the catch latches the cover securely.
4. If the remote is not to be used for an extended period of time it is recommended that the batteries are removed.

IMPORTANT: The batteries should not be exposed to excessive heat such as sunshine, fire or the like. After use, disposable batteries should if possible be taken to a suitable recycling centre. On no account should batteries be disposed of by incineration.

1. Battery compartment
2. Latch
3. Retaining lugs (inside)

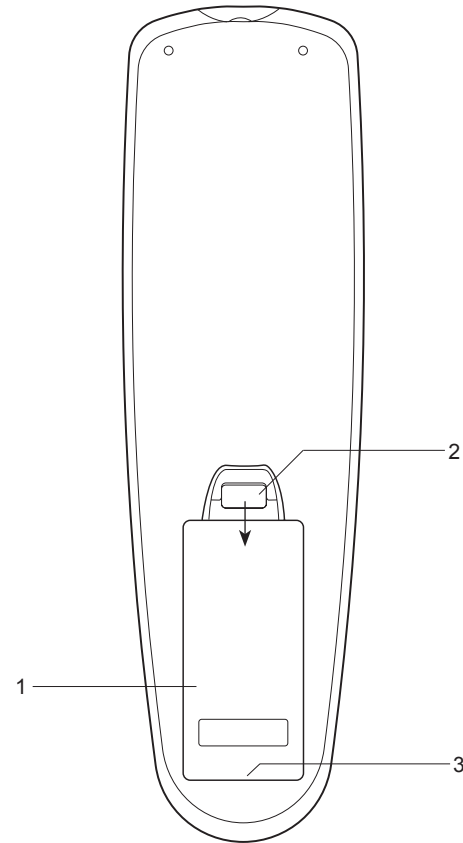

Using the touch panel

The MP-43 sound system has a stylish touch panel instead of conventional buttons.

To operate the buttons simply touch the button area with the tip of a finger for about half a second. The clock set and system menu functions marked with a dot (●) are accessed by means of a long touch (2-3 seconds) on the appropriate button until the display on the sound system shows that the command has been accepted.

You may find that at first, the sound system does not always detect that you have touched a button. If so, try touching with a little more pressure, or for slightly longer. You will soon find the optimum touch needed to control your sound system. (See also Touch Panel Sensitivity Control on page 44.)

The panel may be cleaned using a dry cloth. Do not use abrasives, cleaning fluids or solvents.

Remote control functions

Most of the functions of the MP-43 sound system can be controlled using either the touch panel or the remote control. However, there are a few functions which are only accessible using the remote control. These are:

DAB / FM radio station presets	DAB / FM auto-tune
DAB menu function	CD track access by numbers
CD / iPod random track control	Audio mute

As with the front panel, some operations require a longer operation of the button (explained in the relevant sections). In this case simply keep your finger held on the remote control button for 2-3 seconds until the display on the sound system shows that the command has been accepted.

Display icons

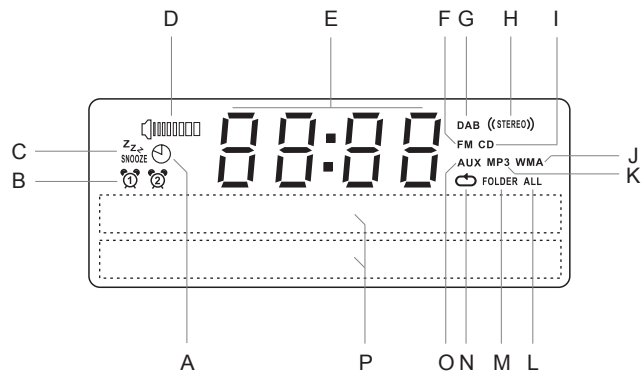

- | | |
|-----------------------------|---------------------------------|
| A. Sleep indicator | I. CD indicator |
| B. Alarm 1 and 2 indicators | J. WMA indicator |
| C. Snooze indicator | K. MP3 indicator |
| D. Speaker indicator | L. Repeat all files indicator |
| E. Clock digits | M. Repeat folder indicator |
| F. FM indicator | N. Repeat single file indicator |
| G. DAB indicator | O. Aux input indicator |
| H. Stereo indicator | P. Two line text display |

Using the sound system for the first time

1. Place your sound system on a flat surface.
2. Fully extend the telescopic aerial. The aerial should be fully extended and positioned vertically for optimum reception.
3. Plug the mains lead into the mains socket located on the back of your sound system ensuring that the plug is pushed fully into the socket.
4. Plug the other end of the mains lead into the wall socket and switch on the wall socket.

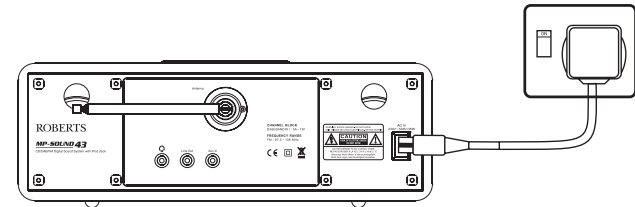

- IMPORTANT:** The mains plug is used as the means of connecting the sound system to the mains supply. The mains socket used for the sound system must remain accessible during normal use. In order to disconnect the sound system from the mains completely, the mains plug should be removed from the mains socket outlet completely.
5. When your sound system is first switched on the clock display will show 12:00 and the unit will enter standby mode. It will then scan for DAB radio stations and when stations have been found the clock and date should be set automatically. Note that the display will not show any scanning message for this first scan.
 6. If no stations have been found then the clock will not set. You may need to relocate your sound system to a position giving better reception. You should then carry out an auto-tune to find DAB stations. See DAB Operation on page 10 and also Finding New Stations on page 13. The clock will then be set from a DAB broadcast.

Operating your sound system - DAB

1. Fully extend the telescopic aerial.
2. If your sound system is in standby mode, press the **On / Standby button** to switch it on.
3. Press and release the **Radio button** to select DAB mode. The display will show "DAB" for a few seconds.
4. If this is the first time the sound system is used a quick scan of UK Band III DAB channels may be carried out (depending on whether scanning was already completed in standby mode). If the radio has been used before, the last used station will be selected.
5. When first switched on, the first station in the list of stations found will be played. The display will show the station name on the upper line of the text display and broadcast information on the lower line.
6. If the station list is still empty after the scan operation or if the selected station cannot be received your radio will display "Station not available".
7. If no signals are found it may be necessary to relocate your sound system to a position giving better reception, and then repeat the scan using the Auto-tune facility (see Finding New Stations on page 13).



DAB/FM/Aux

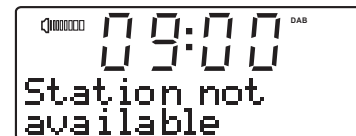
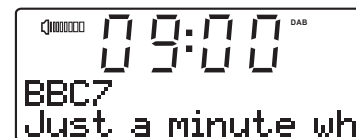

Note that radio station name and frequency displays shown in this user guide may differ from those that you see on your radio. Broadcasters may change radio station names that are transmitted, and the frequencies used for DAB and FM radio stations may not be the same in all parts of the country.

Selecting a station - DAB

1. When the unit is in DAB mode the upper line of the text display normally shows the name of the station currently tuned.
2. Repeatedly press the **Tuning Up** or **Down buttons** to scroll through the list of available stations on the lower line of the text display. Stop pressing the **Tuning buttons** when you find the station that you wish to hear. If you keep pressing one of the tuning buttons then the unit will rapidly scroll through the list of available stations.
3. Press and release the **Select button** to cause the radio to tune to the chosen station. The display may show "Now tuning" while your radio finds the new station.
The use of memory presets is described on page 22.
4. Adjust the **Volume** to the required setting.

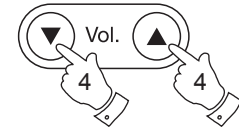

If after selecting a station the display shows "Station not available" it may be necessary to relocate your radio to a position giving better reception.

Secondary services - DAB

1. Certain radio stations have one or more secondary services associated with them. If a station has a secondary service associated with it the display will show ">>" next to the station name on the station list. The secondary service will then appear immediately after the primary service as you press the **Tuning Up button**.
2. Press and release the **Select button** to select the station.



If you need any further advice, please call our Technical Helpline on :-
020 8758 0338 (Mon-Fri)

Display modes - DAB

When in DAB mode your radio has seven display options.



1. Press the **Info button** to cycle through the various modes.



a. Scrolling text Displays scrolling text messages such as artist/track name, phone in number, etc.

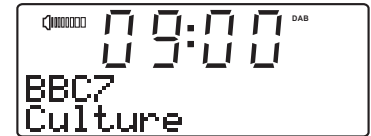

b. Programme type Displays the type of station being listened to e.g. Pop, Classic, News, etc.

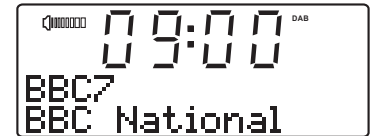

c. Multiplex Name Displays the name of the multiplex to which the current station belongs.

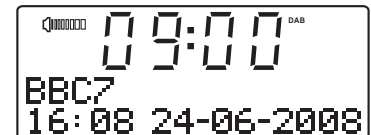

d. Time and date Displays the current time and date.

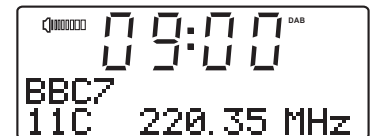

e. Channel & frequency Displays the channel number and frequency for the current DAB radio station.

Display modes - DAB cont.

f. Bit rate/audio type Displays the digital bit rate and audio type for the current DAB radio station.



g. Signal strength Displays signal strength for the station being listened to. The clear rectangle shows the minimum required signal strength for clear DAB reception.



Finding new stations - DAB

As time passes new stations may become available. To find new stations proceed as follows:-

1. With the unit in DAB mode (see page 10) press and release the **Auto-tune button**. The display will then show "Fast scanning". The radio will perform a scan of the UK DAB frequencies. As new stations are found the station counter on the right-hand side of the display will increase and stations will be added to the list.
2. To carry out a full scan of the entire DAB Band III frequencies press and hold the **Auto-tune button** for more than 2 seconds and then release. The display will show "Full scanning". As new stations are found the station counter on the right-hand side of the display will increase and stations will be added to the list.

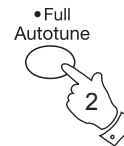
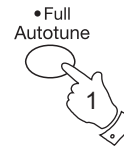

Manual Tuning - DAB

Manual tuning allows you to tune directly to the various DAB Band III channels. UK DAB stations are located in the range 11B to 12D.

1. Press and release the **Menu button** so that the display shows "Station order".
2. Press the **Tuning Up** or **Down buttons** until "Manual tune" appears on the display. Press and release the **Select button**.
3. Press the **Tuning Up** or **Down buttons** to select the required DAB channel.
4. Press and release the **Select button** to select the channel. A signal strength display will appear. The clear rectangle shows the minimum required signal strength for clear DAB reception.
5. Any new stations that are found are automatically added to the stored list of stations.
6. Press and release the **Select button** to return to normal tuning mode.

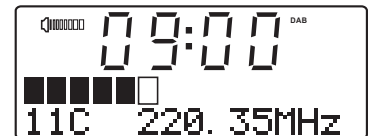
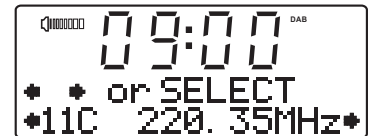
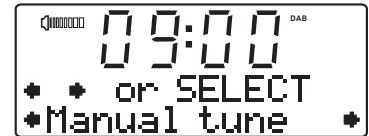
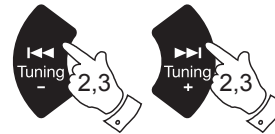
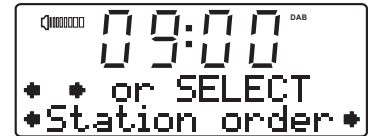

Station order setup - DAB

Your radio has 3 station order settings from which you can choose. The station order settings are, favourite station, alphanumeric and active station.

Note: The default station order setting is alphanumeric.

1. Press and release the **Menu button** so that "Station order" appears on the display. Press the **Select button** to enter the station order selection menu.
2. Press the **Tuning Up or Down buttons** to choose between favourite station, alphanumeric and active station.

Favourite stations

When this setting is selected, after a period of time the most listened to DAB stations will move to the top of the station list and will be marked with the heart symbol ♥.

Alphanumeric

Press the **Tuning Up or Down buttons** until "Alphanumeric" appears on the display. This option will cause DAB stations to be listed in alphanumeric order 0....9 A....Z.

continued on the next page...



Station order setup - DAB - cont.

Active station

Press the **Tuning Up** or **Down buttons** until "Active station" appears on the display. The display will show only those DAB stations for which a signal can be found.

3. Press and release the **Select button** to select the station order setting required.



Prune stations - DAB only

Over time, some DAB services may stop broadcasting, or you may change location and then not be able to receive a station. In order to remove such stations from the DAB station list, the Prune stations function will delete the DAB stations from your station list that can no longer be received.

1. Press and release the **Menu button** so that "Station order" appears on the display. Press and release the **Select button**.
2. Press the **Tuning Up** or **Down buttons** until "Prune stations" appears on the display.
3. Press and release the **Select button** to cause the stations list to be pruned, eliminating unavailable stations.



Software version - DAB only

The software version display cannot be altered and is provided for reference only.

1. To view the DAB software version installed in your sound system, press and release the **Menu button** so that "Station order" appears on display.
2. Press the **Tuning Up** or **Down buttons** until "Software version" appears on the display. The software version will appear on the display.

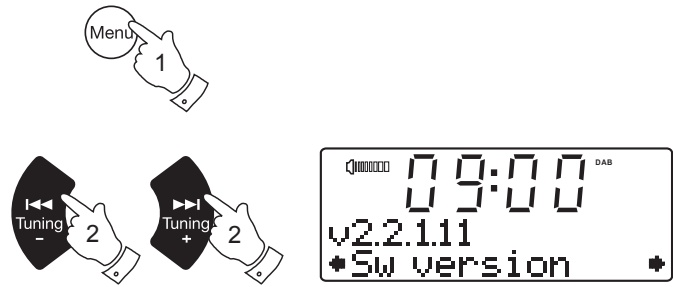

Dynamic Range Control (DRC) settings - DAB only

DRC can make quieter sounds easier to hear when your radio is used in a noisy environment. This function is only for the DAB waveband.

1. Press the **On / Standby button** to switch on your sound system.
2. Press and release the **Menu button** so that "Station order" appears on the display.
3. Press and release the **Tuning Up** or **Down buttons** until the display shows "DRC value".
4. Press and release the **Select button** to enter the DRC adjustment mode.
5. Press and release the **Tuning Up** or **Down buttons** to select the required DRC setting (the default is 0) .
 - DRC 0 DRC is switched off, Broadcast DRC will be ignored.
 - DRC 1/2 DRC level is set to 1/2 that sent by broadcaster.
 - DRC 1 DRC is set as sent by broadcaster.
6. Press and release the **Select button** to confirm the setting. The display will then return to the previous radio display mode.

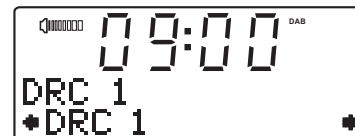
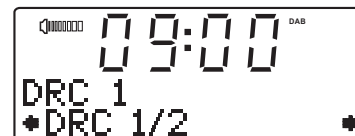
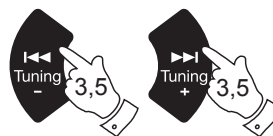
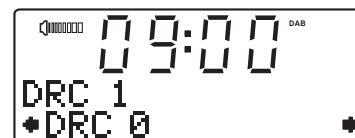
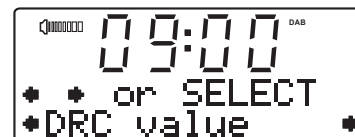

Note: Not all DAB broadcasts are able to use the DRC function. If the broadcast does not support DRC, then the DRC setting in the radio will have no effect.

Operating your radio - Search tuning FM

1. Fully extend the telescopic aerial.
2. Press the **On / Standby button** to switch on your sound system.
3. Press and release the **Radio button** until the FM band is selected.
4. Press and release the **Auto-tune button** to cause your radio to scan in the direction previously scanned and stop automatically when it finds a station of sufficient strength.
5. After a few seconds the display will update. The display will show the frequency of the signal found. If the signal is strong enough and there is RDS data present then the radio will display the station name.
6. To find additional stations press and release the **Auto-tune button** as before.
7. To scan the FM band in a opposite direction press and release either the **Up Tuning button** (to scan low frequency to high frequency) or the **Down Tuning button** (to scan high frequency to low frequency) and then press the **Auto-tune button** again.
8. When the end of the waveband is reached your radio will recommence tuning from the opposite end.
9. Adjust the **Volume** to the required setting.
10. To switch off your radio press the **On / Standby button**.

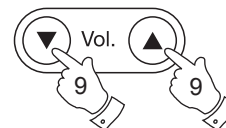
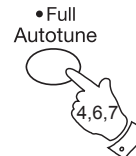

Manual tuning - FM

1. Press the **On / Standby button** to switch on your sound system.
2. Press and release the **Radio button** to select the FM band and fully extend the **Telescopic aerial** for optimal FM reception.
3. Press the **Tuning Up** or **Down buttons** to tune to a station. The frequency will change in steps of 50kHz. Pressing and holding one of the buttons will advance the frequency selection several times each second.
4. When the end of the waveband is reached the radio will recommence tuning from the opposite end.
5. Set the **Volume** to the desired setting.
6. To switch off your sound system press the **On / Standby button**.

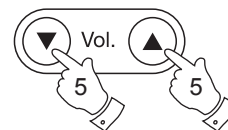
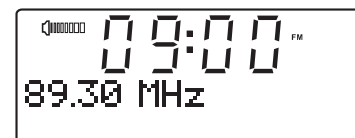

FM stereo / mono

1. If an FM station is received with a weak signal some hiss may be audible. To reduce the hiss press and release the **Select button** so that the Stereo indicator on the display is cancelled. Your radio will switch to mono mode.
2. To return to stereo mode press and release the **Select button** so that Stereo indicator on the display is visible. The radio will switch to stereo mode.



Display modes - FM

Your sound system has four display options for FM radio mode. In addition to the audio content of the programme, data is broadcast using the Radio Data System (RDS). RDS is a system in which inaudible digital information is added to the normal FM radio transmission.

In FM mode the lower line of the text display can be set to any of the following options. If RDS data is received, the upper line of the text display is used to show the radio station name as well as a stereo and RDS indicator ("St" and "RDS")



1. Press the **Info button** to cycle through the various modes.

- | | |
|-------------------|--|
| a. Radio Text | Displays radio text messages such as news items etc. |
| b. Programme Type | Displays the type of station being listened to e.g. Pop, Classic, News, etc. |
| c. Time and date | Displays the current time and date. |
| d. Frequency | Displays the frequency of the station being listened to. |

Note: When tuned to the FM band, information display is only available when the radio is able to receive RDS information from the broadcaster.

2. If there is no RDS data available (or if the signal is too weak) then the radio will display only the FM frequency and the optional Stereo indicator.

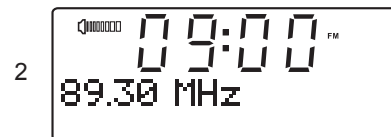
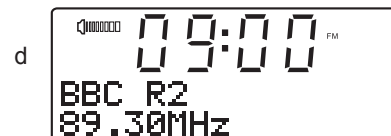
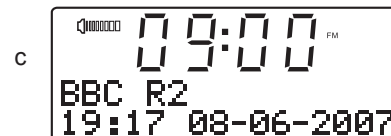
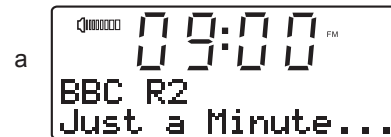

Presetting stations

You may store your preferred DAB and FM radio stations to the preset station memories (1 to 10). The procedure for setting presets and using them to tune stations is the same for FM and DAB modes, and is described below. Note that the radio stores FM and DAB presets separately and so there are ten of each. Presets are preserved in the event of a power failure.

1. Press the **On / Standby button** to switch on your sound system.
2. Tune to the required station as previously described.
3. Press and hold down the required **Preset button** (1 to 10) until the display shows for example "Preset 1 saved". The station will be stored using the chosen preset number. Repeat this procedure for the remaining presets as you wish.
4. Preset memories which have already been stored may be overwritten by following the above procedure if required.

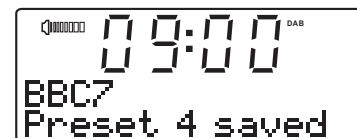
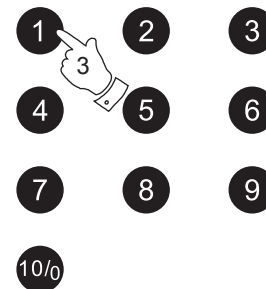

Recalling a preset station

1. Press the **On / Standby button** to switch on your sound system.
2. Select the required waveband by pressing the **Radio** button.
3. Momentarily press the required **Preset button** (1-10) to cause your radio to tune to the station stored in preset memory.

DAB/FM/Aux

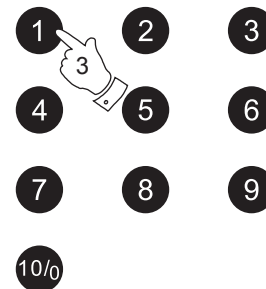

Note: If you have not previously stored a preset station and the preset button is pressed "Empty preset" will be displayed.

Compact discs

Use only Digital Audio CDs which have the  symbol.

Use only full size CDs (12cm diameter) with the sound system. Mini CDs (8cm diameter) are not compatible with the player and may jam the CD mechanism.

Never write on a CD or attach any sticker to the CD. Always hold the CD at the edge and store it in its box after use with the label facing up.

To remove dust and dirt, breathe on the CD and wipe it with a soft, lint free cloth in a straight line from the centre towards the edge.

Cleaning agents may damage the CD.

Do not expose the CD to rain, moisture, sand or to excessive heat. (e.g. from heating equipment or in motor cars parked in the sun).

CD-R / CD-RW discs

Your MP-43 can playback CD-DA format audio CD-R/CD-RW discs that have been finalised* upon completion of recording.

Your MP-43 may fail to play some CD-R/CD-RW discs due to poor recording and wide variation in quality of the CD-R/CD-RW disc.

*Finalising enables a CD-R/CD-RW disc to playback on audio players such as your MP-43. A disc which has not been finalised may have information added to it using a computer but may not always be playable.

*If you need any further advice, please call our Technical Helpline on :-
020 8758 0338 (Mon-Fri)*

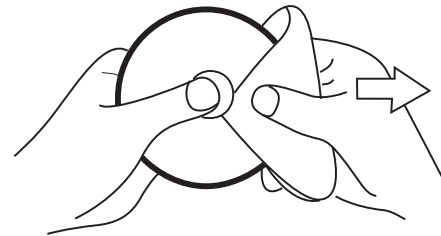

Inserting a CD

Ensure the CD player is empty before inserting a disc. If there is a disc in the player then the CD indicator will be lit. If you cannot insert a disc, press the **CD Eject button** to remove the CD currently in the player.

1. Press the **On / Standby button** to switch on your sound system.
2. To select the CD mode press the **Media button** until "CD" shows on the upper line of the display.
3. To eject a CD press and release the **CD Eject button**. To reload a CD that has just been ejected, press the **Eject button** a second time.
4. Insert a disc with printed side facing up into the CD slot. The disc will be loaded automatically. The unit will check the CD type and load its track list. The display will show "LOADING" and then "READING" as the information is read.
5. If you load a disc containing MP3 or WMA files your sound system will enter the MP3 / WMA mode (see page 28).

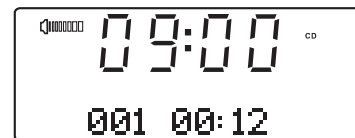

Playing a CD

1. Press the **Play / Pause button** to start playing the disc. The display will show the first track number.
2. Adjust the **Volume** to the required setting.
3. To pause playing press the **Play / Pause button**. To resume press the **Play / Pause button** again.

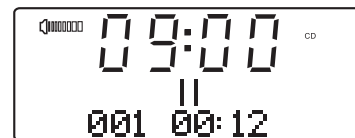
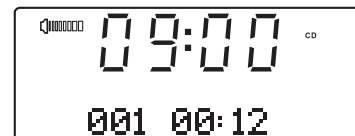

- To stop play, press the **Stop button**. The total number of CD tracks and the stop symbol (■) will be displayed.

If you put the unit into standby mode without pressing the Stop button, then the next time the unit is switched on it will return to the previously played track.



- To take out the CD, press the **CD Eject button**. The display will show "EJECT". In order to protect the disc if it is not removed, the unit will reload the CD after 10 seconds and then enter standby mode.

Selecting a track

- While the CD is playing, press either the **Fast-forward** or **Rewind buttons** to change to the desired track. The updated track number is shown in the display.

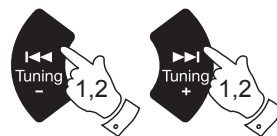

- You can also skip tracks when the player is paused or stopped. Skip to the desired track using the **Fast-forward** or **Rewind buttons**, release the button when the desired track is displayed.

- Press the **Play / Pause button** to play the selected track.

Select a desired track

- For track numbers 1-9 simply press the corresponding digit button. For track numbers ten and above press the required digits using the 10/0 button to enter the digit zero.
- If the track number entered exceeds the number of tracks on the CD, then the last track on the CD will be played.

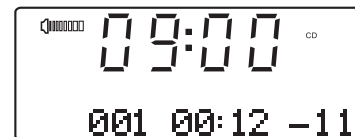
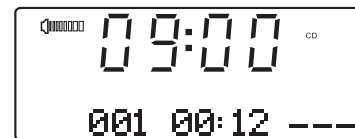
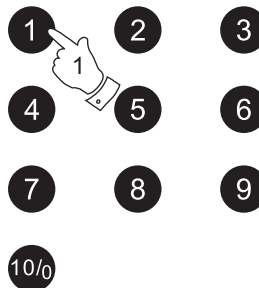

Search function

1. While the CD is playing, press and hold the **Fast-forward** or **Rewind buttons**. Release the button when the desired part of the track is reached.



Repeat a single track

2. While the CD is playing, press the **Repeat button** until the repeat single track symbol (↺) appears in the display. The current track will be repeated.

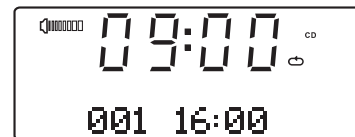
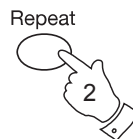

Repeat all tracks

3. While the CD is playing, press the **Repeat button** until the repeat all tracks symbol (ALL) appears in the display. All of the tracks on the CD will be played repeatedly.

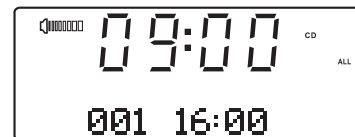
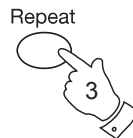

Play tracks introduction

4. While the CD is playing, press the **Repeat button** until the track introduction symbol (INT) appears in the display. The first 10 seconds of each track will be played. When the desired track is reached, press the **Repeat button** once more to revert to normal play mode.

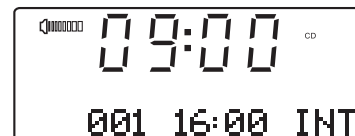

Play tracks in random order

5. While the CD is playing, press the **Random button** until the random symbol (RAN) appears in the display. The tracks will be played in random order. To cancel the random playback function, press the **Random button** a second time.

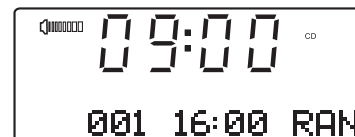

CD track programming

In addition to playing of complete CDs, selected tracks, or a random selection, the CD player allows you to programme a sequence of up to 20 tracks to be played in whatever order you choose.

1. With the unit in CD mode and with a CD inserted, make sure that the CD is stopped (press the **Stop / Select button**).
2. To enter programming mode, press the **Menu button**.
3. Choose the first track using the **Fast-forward** or **Rewind buttons**.
4. Press the **Menu button** to enter the selected track into the programme.
5. Choose another track using the **Fast-forward** or **Rewind buttons**, and enter it into the programme using the **Menu button** (track 6 in example shown).
6. Repeat step 5 to store as many as 20 tracks in the programme.
7. When the programme is complete, press the **Play / Pause button** to start playing. The tracks will then be played in the order that you have just programmed.
8. Pressing the **Stop / Select button**, or switching to another operating mode will erase the programme.

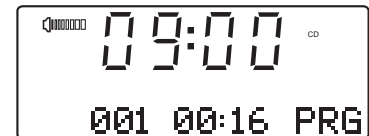
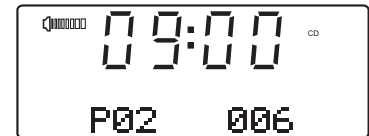
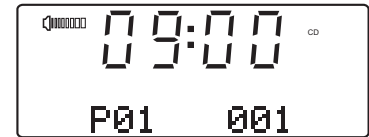

Note: If you are programming the tracks using a CD with MP3 or WMA files in folders (see the following pages), you can also use the **Up** or **Down Folder buttons** to specify the folder in steps 3 and 5 above.

If you need any further advice, please call our Technical Helpline on :-
020 8758 0338 (Mon-Fri)

MP3 / WMA CD Mode

The MP-43 is able to play CD-R and CD-RW discs containing MP3 and WMA files. It is assumed in this section that a file is equivalent to a CD track.

An MP3 / WMA CD may not contain more than 511 files and not more than 99 folders. MP3 and WMA files should be created with an audio sample rate of 44.1kHz (this is normal for files created from CD audio content). MP3 and WMA data rates up to 320 kilobits per second are supported. WMA Lossless files are not supported. The unit will not play files which include digital rights management (DRM) protection.

When burning CD-R and CD-RW discs with audio files, various problems may arise which could lead to problems with playback. Typically such problems are caused by poor CD writing or audio encoding software, or by the hardware settings of the PC's CD writer, or by the CD being used. Should such problems arise, contact the customer services of your CD writer or software manufacturer or look in their product documentation for relevant information. When you are making audio CDs, take care to observe all legal guidelines and ensure that the copyright of third parties is not infringed.

1. To select the CD mode press the **Media button** until "CD" shows on the display, or insert a suitably prepared CD-R or CD-RW disc.
2. Insert a CD with printed side facing up into the CD slot. The disc will be loaded automatically. The unit will check the CD type and load its track list. The display will show "loading" and then "reading" as the information is read.

If there are many files or folders on the CD then it may take some tens of seconds to read all of the file and folder names and to identify those which are playable (with .mp3 or .wma filename extension).

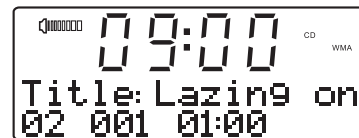

Playing an MP3 / WMA CD

1. Press the **Play / Pause button** to start playing from the CD. The display will show the first folder and file numbers - "01" and "001".
2. To pause playing press the **Play / Pause button**. To resume playing press the **Play / Pause button** again.
3. To stop play, press the **Stop button**. The total number of files on the disc and "STOP" will be displayed.
If you put the unit into standby mode without pressing the Stop button, then the next time the unit is switched on it will return to the previously played file.
4. To take out the CD, press the **CD Eject button**. The display will show "EJECT". In order to protect the disc if it is not removed, the unit will reload the disc after 10 seconds and then enter standby mode. To reload a CD that has just been ejected, press the **Eject button** a second time.

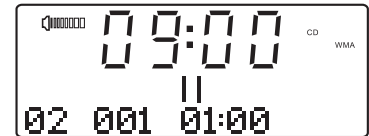

Selecting a file

1. While the CD is playing, press either the **Fast-forward** or **Rewind buttons** to change to the desired file, the file number is updated in the display. If there is more than one folder, when all files in the current folder have been played the next folder will be played.
2. You can also skip files when the player is in stop mode. Skip to the desired file using the **Fast-forward** or **Rewind buttons** and release the button when the desired file number is displayed.
3. Press the **Play / Pause button** to play the selected file.



If you need any further advice, please call our Technical Helpline on :-
020 8758 0338 (Mon-Fri)

Select a specific file

1. For file numbers 1-9 simply press the corresponding digit button. For file numbers ten and above press the required digits using the 10/0 button to enter the digit zero.
3. If the file number entered exceeds the number of playable files on the CD, then the last file will be played.

File numbers up to 511 may be entered. The numbers of files in folders are added together. So, for example, if the first two folders each contain 10 files, then entering 15 will play the fifth file in the second folder.

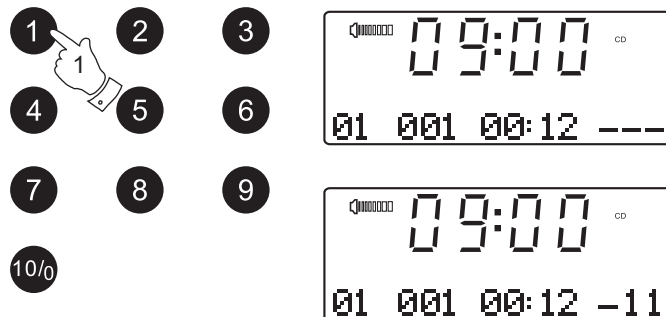

Search function

1. While the MP3 / WMA CD is playing, press and hold the **Fast-forward** or **Rewind buttons**. Release the button when the desired part of the current file is reached.

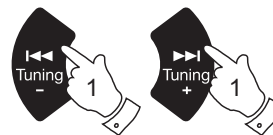

To skip to another folder

1. With the MP3 / WMA CD in stop or play mode, press and release either the **Up** or **Down Folder button**. The first file of the next or previous folder will be played.

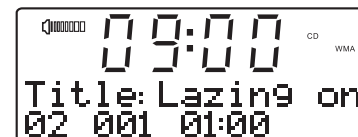
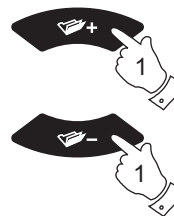

Repeat, Intro, Random and Programmed play

The MP-43 allows you to use the same playback options for files as can be used for conventional audio CDs (see pages 26-27). In addition to Repeat Once and Repeat All options, there is also a Repeat Folder facility.

Your MP-43 sound system has an iPod dock facility which allows you to play digital audio files and video soundtracks held on your iPod directly.

The MP-43 uses the Universal Dock Connector developed for use with iPods. Recent models of iPod are supplied with adaptor inserts which ensure correct alignment of the iPod with the electrical connector. Earlier models of iPod were not supplied with the necessary inserts, and so your MP-43 is supplied with insert types 1 - 7. Should you require a later insert to use your iPod with the MP-43, then please contact an iPod accessories supplier.

1. Ensure that the sound system is in standby. Carefully remove the iPod dock connector cover from the top of your sound system.
2. Place the iPod docking adaptor (types 1 - 7 supplied with the MP-43) into the iPod docking recess so that it is securely seated.
3. Carefully place your iPod on the universal iPod dock connector then press the **On / Standby button** to switch on the sound system. **To avoid possible damage to either device, not use your iPod without the correct adaptor fitted in the dock connector.**
4. To select the iPod mode press the **Media button** until "iPod" shows on the display. If it was previously playing, your iPod will switch on and continue playing from where it was previously stopped.

Note: The MP-43 sound system is able to recharge your iPod's internal battery. Recharging does not take place while your MP-43 is using DAB or FM radio.

Your iPod will use its backlight settings as configured. If these need changing, use the iPod's *Settings* menu.

If you need any further advice, please call our Technical Helpline on :-
020 8758 0338 (Mon-Fri)

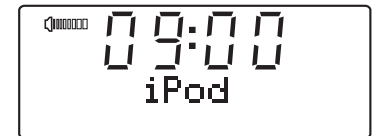
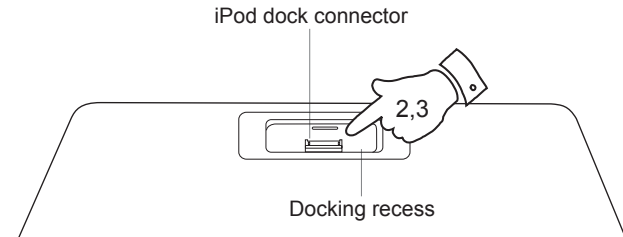

Navigating your iPod

1. Use the **Menu button** on the remote control to navigate to higher level menus on your iPod.
2. Use the **Folder Up** or **Down buttons** on the remote control as required to move up and down a menu screen on your iPod.
3. Press the **Select button** to choose the highlighted on screen menu item. If this item is a lower level menu item, you may then navigate further using the **Folder Up** or **Down** and **Select buttons**.

Playing a file on your iPod

1. When you have found the required item use the **Select button** to start the iPod playing (or the **Play / Pause button** - but see note below).
2. Adjust the volume to the required setting using the **Volume Up** and **Down buttons** on your sound system.
3. To pause playback press the **Play/Pause button**. To resume playback press the **Play / Pause button** again.
4. iPod's do not have a Stop button (they use the Pause function). To play an alternative selection, use the iPod menus to make the selection using the **Play / Pause button** to stop playing the current item if needed.

Note: iPods vary in how they respond to the **Play/Pause button** dependent upon the iPod model and software revision. Play / Pause may pause and resume the current selection, or it may pause the current selection and then start playing a new selection. The use of the **Select button** to start playing an item avoids this inconsistency.

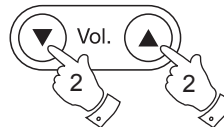

Search function

1. While the iPod is playing, press and hold the **Fast-forward** or **Rewind buttons**.
2. Release the button when the desired part of the item is reached.



Repeat a single file

1. While the iPod is playing, press the **Repeat button** until the repeat single file symbol appears in the iPod display. The currently playing item will be repeated.

Repeat



Repeat all

2. While the iPod is playing, press the **Repeat button** until the repeat all files symbol appears in the iPod display. All files in the current album or playlist will be repeated.

Repeat cancel

3. While the iPod is playing, press the **Repeat button** until the repeat symbol is removed from the iPod display. Remaining files in the current album or playlist will be played.

Shuffle

4. While the iPod is playing, press the **Random button** to control the shuffle symbol in the iPod display. The tracks in the current album or playlist will be played in random when shuffle is enabled.

Random



Alarms

Your MP-43 sound system has two alarms which can each be set to wake you to DAB, FM radio, CD, iPod or buzzer alarm. The alarms may be set while the unit is in standby mode or while playing.

1. Before setting an alarm ensure that the clock time is set (see page 37). Press and release the **Alarm button**. "Alarm 1" will show on the display.
2. Press the **Tuning Up** or **Down buttons** to select the required alarm, 1 or 2. Press and release the **Select button** to cause "Alarm setting" to show on the display.
3. Press and release the **Select button** to choose alarm setting. "Alarm: On/Off" will show on the upper line of the text display.
4. Press the **Tuning Up** or **Down buttons** to choose whether to set the alarm to On or Off.
5. Press and release the **Select button**. If the previous selection was to switch on the alarm, then "Alarm: Time" will show on the upper line of the text display and the Alarm hour digits will flash. If Off was selected, the unit will exit the alarm menu.
6. Press the **Tuning Up** or **Down buttons** to choose the alarm hour and then press and release the **Select button** to enter the hour setting. The Alarm minute digits will then flash on the display.
7. Press the **Tuning Up** or **Down buttons** to choose the alarm minute and then press and release the **Select button** to enter the minute setting. "Alarm: Mode" will show on the upper line of the text display.

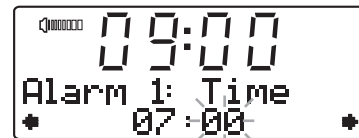
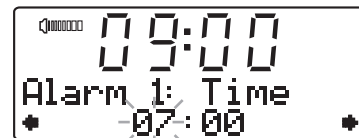
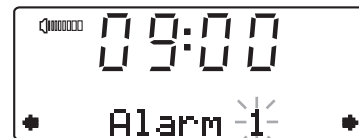
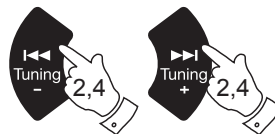

8. Press the **Tuning Up or Down buttons** to choose the required alarm mode and then press the **Select button** to confirm the setting.

Each alarm can be set to any of the following modes:

BUZZER	- will wake you with a buzzer alarm
DAB	- will wake you with DAB radio
FM	- will wake you with FM radio
CD	- will wake you playing a CD
iPod	- will wake you playing your iPod

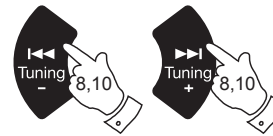

9. Press and release the **Select button** to select the alarm mode. "Alarm: Day" will show on the upper line of the text display.



10. Press the **Tuning Up or Down buttons** to select the required day option and then press the **Select button** to confirm the setting.

Your alarm can be set to the following options:

Once	- will sound once in the next 24 hours only
Daily	- will sound everyday
Weekdays	- will sound only on weekdays
Weekends	- will sound only on weekends

11. The alarm has now been set and the unit will revert to the previous display. The alarm indicator (alarm 1 or 2) will show on the display.

To view an alarm setting, select "View" instead of "Setting" at steps 2 and 3. Successive presses of the **Select button** will display the alarm details.

Note: When the alarm is set to wake by DAB or FM radio, the last used DAB or FM station will be used and the alarm volume will be the volume previously listened to.

When the buzzer alarm activates, the alarm will start softly and gradually increase in level.

The alarm will sound for 60 minutes unless cancelled.

If you need any further advice, please call our Technical Helpline on :-
020 8758 0338 (Mon-Fri)

Cancelling alarms

1. While an alarm is sounding it can be cancelled by pressing the **On / Standby button**.
2. To cancel an alarm at any other time, enter the alarm setup menu and set the alarm On/Off option to "Off". See steps 1 - 5 on page 34.



Snooze

1. When the alarm sounds, pressing **any button** other than the Standby button will silence the alarm for five minutes. The snooze symbol () will appear in the display.

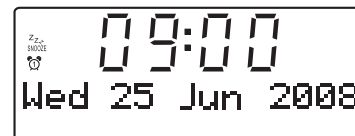

Sleep function

Your sound system can be set to turn off after a preset time has elapsed. The sleep setting can be adjusted between 15 and 120 minutes.

1. To use the sleep timer, press and release the **Sleep / Clock set button** to enter the sleep setup. "Sleep off" will appear on the display.
2. Repeatedly press and release the **Sleep / Clock set button** to select the desired sleep time. The options are 15, 30, 60, 90 or 120 minutes. Use the OFF option to cancel the sleep function.
3. Your radio will switch off after the preset sleep time has elapsed.
4. To cancel the sleep function before the preset time has elapsed, either set the sleep timer to off (step 2) or press the **On / Standby button**.

Clock Set

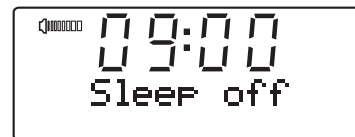

Setting the clock manually

The MP-43 will automatically set its clock when tuned to a DAB radio station or to an FM station which is broadcasting the time via RDS.

If the clock cannot be set using DAB or FM radio then you will need to set the clock manually before the alarm function can be used. The clock may be set while the unit is in standby mode or while playing. The clock display is always in 24 hour format.

If it becomes necessary to set the clock manually, please follow these steps:

1. Press and hold the **Clock Set button**. The hour digits on the display will flash.
2. Press the **Tuning Up** or **Down buttons** to change the hour digits as needed. Keep the button pressed to cause the digits to change more quickly.
3. Press and release the **Select button** to confirm the hour setting. The minute digits on the display will flash.
4. Press the **Tuning Up** or **Down buttons** to change the minute digits as needed. Keep the button pressed to cause the digits to change more quickly.
5. Press and release the **Select button** to confirm the minutes setting. The year digits on the display will flash.

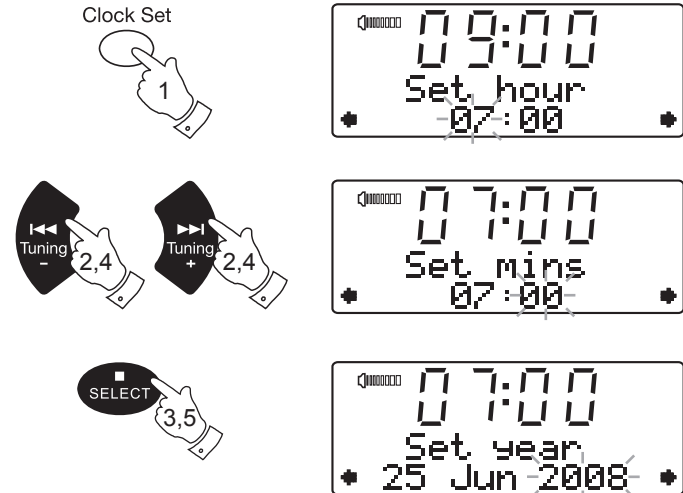

6. Press the **Tuning Up** or **Down buttons** until the desired year is set. Keep the button pressed to cause the digits to change more quickly.
7. Press and release the **Select button** to confirm the year setting. The month will flash on the display.
8. Press the **Tuning Up** or **Down buttons** until the desired month is set. Keep the button pressed to cause the month to change more quickly.
9. Press and release the **Select button** to confirm the month setting. The day number will flash on the display.
10. Press the **Tuning Up** or **Down buttons** until the desired day is set. Keep the button pressed to cause the digits to change more quickly.
11. Press and release the **Select button** to confirm the day and to complete the clock and date setting. The display will revert to the display for the previous operating mode.

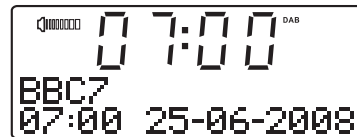
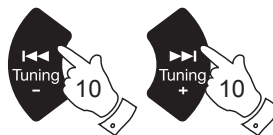

Standby brightness control

The brightness of the display when the unit is in standby mode may be adjusted. If you use the unit in the bedroom, you may prefer a lower standby brightness level than the standard setting.

1. Press and hold the **Menu button** so that the display shows "Set Brightness" on the lower line of the text display
2. Press and release the **Select button** to show the current setting.
3. Press and release the **Tuning Up** or **Down buttons** to change the standby brightness level. The backlight level will change at the same time so that you can see the effect of the change.
4. Press and release the **Select button** to save the new setting.

The default setting after a system reset is 5. Possible brightness values range from 1 - 7.

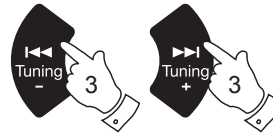

Clock and Alarms



Equalizer function

The sound on your sound system can be adjusted to suit your personal taste for the material that you are listening to. The MP-43 has six preset equalizer modes. Alternatively, you may set the treble and bass levels to your own preferences.

1. Press the **Equalizer button** to cycle through the various modes.
 - a. Flat - no tone modification is applied
 - b. Jazz
 - c. Rock
 - d. Classic
 - e. Pop
 - f. News
 - g. Treble - tone setting may be adjusted
 - h. Bass - tone setting may be adjusted

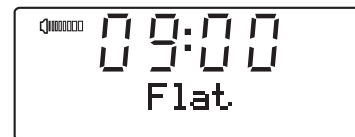

Treble control

2. Press the **Equalizer button** to cycle through the modes until "Treble" appears on the upper line of the text display. The current treble setting will be shown on the lower line.
3. To adjust the treble setting press and release the **Tuning Up or Down buttons** until the desired level is displayed.
4. If you wish also to adjust the bass, then press the **Equalizer button** once more as described in step 5. Alternatively press the **Select button** to revert to the play mode display.

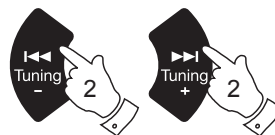
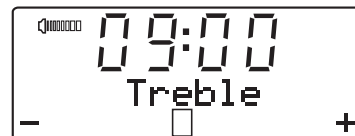

Bass control

5. Press the **Equalizer button** to cycle through the modes until "Bass" appears on the upper line of the text display. The current bass setting will be shown on the lower line.
 6. To adjust the bass setting press and release the **Tuning Up or Down buttons** until the desired level is displayed.
 7. Press the **Select button** to revert to the play mode display.
- To quickly cancel the effect of the treble or bass settings press the **Equaliser button** until "Flat" appears on the upper line of the display. The treble and bass settings will be remembered for the next time that you wish to adjust them.

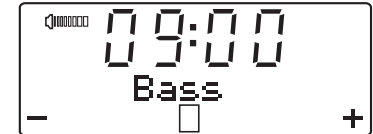
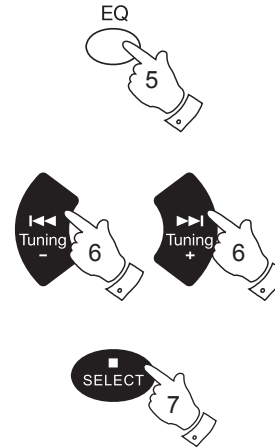

Mute function

Pressing the Mute button will mute the output from the loudspeakers.

1. Press the **Mute button** to mute the sound output. The speaker volume symbol on the display will disappear.
2. Press the **Mute button** again or one of the **Volume buttons** to un-mute the sound output.

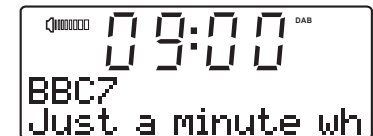
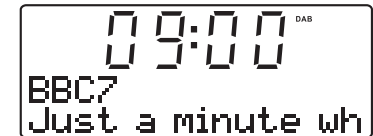

Auxiliary input socket

A 3.5mm stereo **Auxiliary Input socket** is provided on the rear of your sound system to permit an audio signal to be fed into the unit from an external audio device such as iPod, MP3 or CD player.

1. Repeatedly press and release the **Radio button** until "AUX IN" is displayed.
2. Connect an external audio source (for example, iPod, MP3 or CD player) to the **Auxiliary input socket**.
3. Adjust the volume setting on your iPod, MP3 or CD player if necessary to ensure an adequate signal level, and then use the **Volume Up** or **Down buttons** on the sound system as needed for comfortable listening.

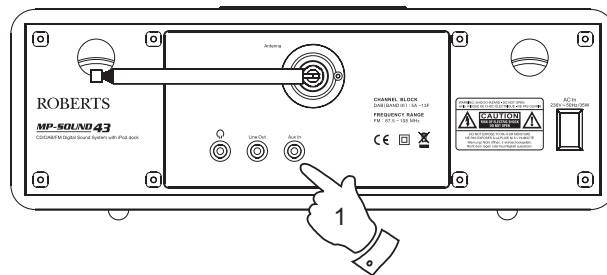

DAB/FM/Aux



Line Out socket

A 3.5mm stereo **Line Out socket** is provided on the rear of your sound system to permit the audio signal to be fed to an external amplifier or other audio device.

Inserting an audio cable into this socket will not mute the internal loudspeaker. Set the volume control to a low level if desired (minimum level = 1). Setting the volume to MIN may cause the line output to be muted.

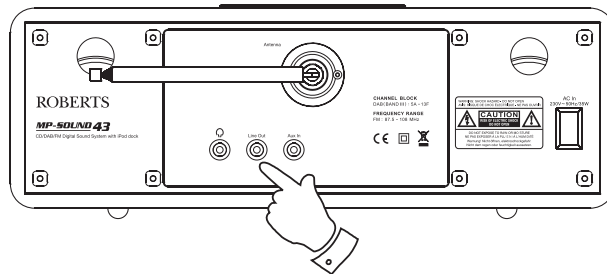

Headphone socket

A 3.5mm stereo **Headphone Socket** is provided on the rear of your sound system for use with headphones. Inserting a plug automatically mutes the internal loudspeakers.

IMPORTANT: Excessive sound pressure from earphones and headphones can cause hearing loss.

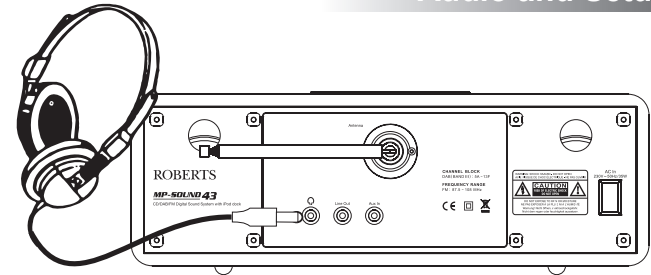

Aerial removal

The fitted telescopic aerial is suitable for most applications. In some locations if reception conditions are poor, an external antenna may be more suitable. For this purpose the telescopic aerial may be removed to allow connection to an external aerial using a coaxial cable.

First remove the two small screws holding the antenna connector cover in place using a small cross-head screw driver. Then using a suitable spanner (11mm across the flats), remove the telescopic aerial by rotating in an anti-clockwise direction when viewed from the rear of the product.

This will expose an F-type connector to which a coaxial cable may then be connected.

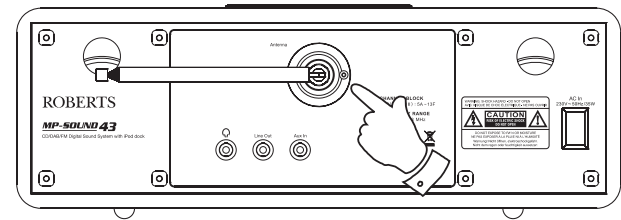

Touch panel sensitivity control

The sensitivity of the touch panel may be adjusted. The default setting will normally be found to provide satisfactory operation, however, the touch panel system may respond differently depending upon the moisture of the skin. The touch panel sensitivity may be reduced or increased relative to the standard setting.

1. Press and hold the **Menu button** so that the display shows "Set Brightness" on the lower line of the text display
2. Press and release the **Tuning Up** or **Down buttons** until the display shows "Touch Pad Set".
3. Press and release the **Select button** to show the current setting.
4. Press and release the **Tuning Up** or **Down buttons** to change the touch panel sensitivity level.
5. Press and release the **Select button** to save the new setting.

The default setting after a system reset is Normal.

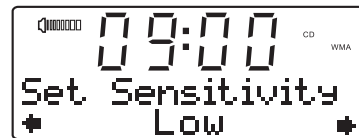
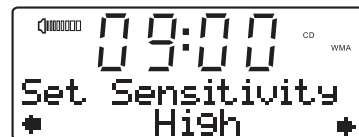

System reset

If your radio fails to operate correctly, or some digits on the display are missing or incomplete carry out the following procedure.

1. Press and hold the **Menu button** so that the display shows "Set Brightness" on the lower line of the text display.
2. Press and release the **Tuning Up** or **Down buttons** until the display shows "System reset".
3. Press and release the **Select button**. The display will show "Press SELECT to reset".
4. Press and release the **Select button** again to confirm the reset operation.
5. After a system reset, all radio station presets will be set to empty. Alarms will be cancelled, audio equaliser, display brightness and touch panel settings will have been set to their default values. The clock will be reset and the unit will behave as when first switched on (see page 9).

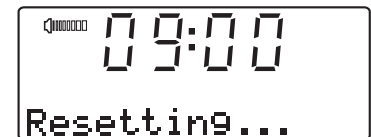
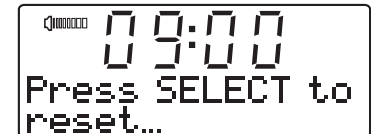
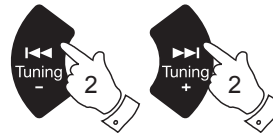
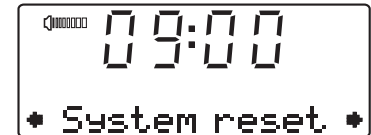

In case of malfunction due to electrostatic discharge, reset the product using the above procedure. In some circumstances it may be necessary to disconnect and then reconnect the mains power in order to resume normal operation.

If a problem persists our technical staff would be pleased to help offer any assistance on operating the radio. Our technical helpline number is 020 8758 0338.

Cautions

Do not allow this sound system to be exposed to water, steam or sand. Do not leave your sound system where excessive heat could cause damage.

It is recommended that the DAB band is used for radio listening where possible since this may result in better sound quality and freedom from interference than will often be obtained on the FM band.

The name plate is located on the rear of your sound system.

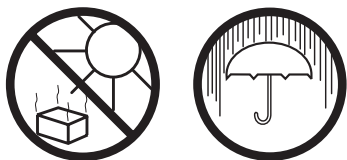

- The sound system shall not be exposed to dripping or splashing and that no objects filled with liquids, such as vases, shall be placed on the sound system.
- It is recommended to operate the product such that there is a minimum distance (10cm recommended) to adjacent objects in order to ensure good ventilation.
- The ventilation of the product should not be restricted by covering it or its ventilation openings with items such as newspapers, tablecloths, curtains etc.
- No naked flame sources such as lighted candles should be placed on the product.
- It is recommended to avoid using or storing the product at extremes of temperature. Avoid leaving the unit in cars, on window sills, in direct sunlight etc.

Specifications

Power Requirements

Mains	AC 230 volts, 50Hz ~ only
Battery (Remote control)	2 x AAA

Frequency Coverage

FM	87.5-108MHz
DAB	174.928 - 239.200MHz

Circuit features

Output Power	2 x 7 watts	
Headphone socket	3.5mm dia	
Auxiliary in socket	3.5mm dia	
Line Out socket	3.5mm dia	
Aerial System	FM	Telescopic aerial
	DAB	Telescopic aerial

The Company reserves the right to amend the specification without notice.

Mains supply

The MP-43 will operate from a supply of AC 230 volts, 50Hz  only.

DO NOT cut off the mains plug from this equipment. If the plug fitted is not suitable for the power points in your home or the cable is too short to reach a power point, then obtain an appropriate safety approved extension lead or adaptor. If in doubt consult your dealer.

If nonetheless the mains plug is cut off, remove the fuse and dispose of the plug immediately to avoid a possible shock hazard by inadvertent connection to the mains supply.

If this product is not supplied with a mains plug, or one has to be fitted, then follow the instructions given below:

IMPORTANT. DO NOT make any connection to the larger terminal which is marked with the letter E or by the safety earth symbol  or coloured Green or Green-and-yellow.

The wires in the mains lead are coloured in accordance with the following codes :-

BLUE - NEUTRAL

BROWN - LIVE

The wire coloured BLUE must be connected to the terminal marked N or coloured BLACK.

The wire coloured BROWN must be connected to the terminal marked L or coloured RED.

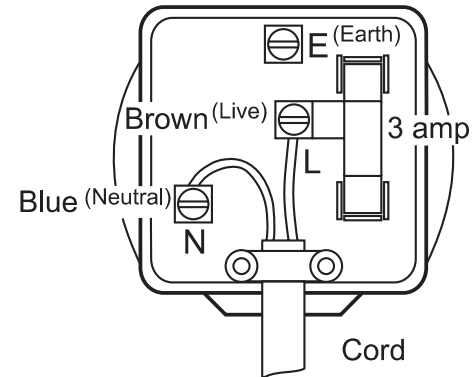

Fuse

When replacing the fuse only a 3A AASTA approved to BS1362 type should be used and be sure to re-fit the fuse cover.

IF IN DOUBT - CONSULT A QUALIFIED ELECTRICIAN.

Replacement fuse holders are available from Roberts Radio Technical Services at the address shown on the rear of this manual.

Notes

A series of horizontal dotted lines for writing notes, spanning the width of the page.

This instrument is guaranteed for twelve months from the date of delivery to the original owner against failure due to faulty workmanship or component breakdown, subject to the procedure stated below. Should any component or part fail during this guarantee period it will be repaired or replaced free of charge.

The guarantee does not cover:

1. Damage resulting from incorrect use.
2. Consequential damage.
3. Receivers with removed or defaced serial numbers.

N.B. Damaged or broken telescopic aerials will not be replaced under guarantee.

Procedure:

Any claim under this guarantee should be made through the dealer from whom the instrument was purchased. It is likely that your Roberts' dealer will be able to attend to any defect quickly and efficiently but should it be necessary the dealer will return the instrument to the Company's service department for attention. In the event that it is not possible to return the instrument to the Roberts' dealer from whom it was purchased, please contact Roberts Radio Technical Services at the address shown overleaf.

These statements do not affect the statutory rights of a consumer.

ROBERTS RADIO TECHNICAL SERVICES

97-99 Worton Road

Isleworth

Middlesex

TW7 6EG

Technical Helpline :- 020 8758 0338 (Mon-Fri during office hours)

Website: <http://www.robertsradio.co.uk>

