

Operating Instructions

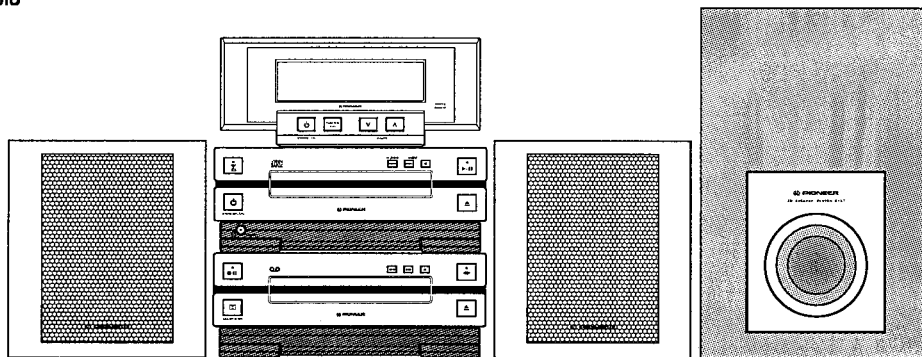

STEREO CD RECEIVER **XC-L7 (DU-L7)** STEREO CASSETTE DECK **CT-L7** SPEAKER SYSTEM **S-L7, S-L7-A**



Thank you for buying this PIONEER product. Please read through these operating instructions so you will know how to operate your model properly. After you have finished reading the instructions, put them away in a safe place for future reference. In some countries or regions, the shape of the power plug and power outlet may sometimes differ from that shown in the explanatory drawings. However, the method of connecting and operating the unit is the same.

WARNING: TO PREVENT FIRE OR SHOCK HAZARD, DO NOT EXPOSE THIS APPLIANCE TO RAIN OR MOISTURE.

THE POWER SWITCH IS SECONDARY CONNECTED AND THEREFORE DOES NOT SEPARATE THE UNIT FROM MAINS POWER IN THE STANDBY POSITION.

This product complies with the Low Voltage Directive (73/23/EEC), EMC Directives (89/336/EEC, 92/31/EEC) and CE Marking Directive (93/68/EEC).

IMPORTANT 1



The lightning flash with arrowhead symbol, within an equilateral triangle, is intended to alert the user to the presence of uninsulated 'dangerous voltage' within the product's enclosure that may be of sufficient magnitude to constitute a risk of electric shock to persons.

CAUTION
RISK OF ELECTRIC SHOCK
DO NOT OPEN

CAUTION:
TO PREVENT THE RISK OF ELECTRIC SHOCK, DO NOT REMOVE COVER (OR BACK). NO USER-SERVICEABLE PARTS INSIDE. REFER SERVICING TO QUALIFIED SERVICE PERSONNEL.



The exclamation point within an equilateral triangle is intended to alert the user to the presence of important operating and maintenance (servicing) instructions in the literature accompanying the appliance.

IMPORTANT FOR USE IN THE UNITED KINGDOM

The wires in this mains lead are coloured in accordance with the following code:

Blue : Neutral
Brown : Live

If the plug provided is unsuitable for your socket outlets, the plug must be cut off and a suitable plug fitted.

The cut-off plug should be disposed of and must not be inserted into any 13 amp socket as this can result in electric shock. The plug or adaptor of the distribution panel should be provided with a 5 amp fuse. As the colours of the wires in the mains lead of this appliance may not correspond with coloured markings identifying the terminals in your plug, proceed as follows:
The wire which is coloured blue must be connected to the terminal which is marked with the letter N or coloured black.
The wire which is coloured brown must be connected to the terminal which is marked with the letter L or coloured red.

Do not connect either wire to the earth terminal of a three-pin plug.

NOTE

After replacing or changing a fuse, the fuse cover in the plug must be replaced with a fuse cover which corresponds to the colour of the insert in the base of the plug or the word that is embossed on the base of the plug, and the appliance must not be used without a fuse cover. If lost, replacement fuse covers can be obtained from your dealer. Only 5 A fuses approved by B.S.I. or A.S.T.A. to B.S. 1362 should be used.



CAUTION
RISK OF ELECTRIC SHOCK
DO NOT OPEN

ATTENTION
DANGER D'ELECTROCUTION
NE PAS OUVRIR

These labels can be found on the unit's bottom panel.

[For Stereo CD Receiver XC-L7]

CAUTION

This product contains a laser diode of higher class than 1. To ensure continued safety, do not remove any covers or attempt to gain access to the inside of the product. Refer all servicing to qualified personnel.

The following caution label appears on your unit.

Location: Bottom of the unit.

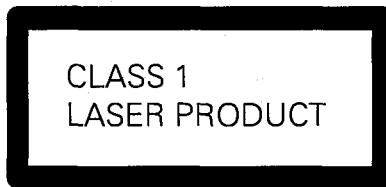

WARNING!

Lithium batteries. Danger of explosion. Replacement must be done by qualified personnel and only by following the instructions given in the service manual.

INFRINGEMENT TO COPYRIGHT

Recording and playback of copyrighted material may require consent. See the Copyright Act 1956 and the Performers' Protection Acts 1958 and 1972.

CAUTIONS REGARDING HANDLING

LOCATION

Install the unit in a well-ventilated location where it will not be exposed to high temperatures or humidity.

Do not install the unit in a location which is exposed to direct rays of the sun, or near hot appliances or radiators. Excessive heat can adversely affect the cabinet and internal components. Installation of the unit in a damp or dusty environment may also result in a malfunction or an accident. (Avoid installation near cookers etc., where the unit may be exposed to oily smoke, steam or heat.)

Do not install the unit on a tottered stand, nor on an unstable or inclined surface.

CONDENSATION

When this unit is brought into a warm room from previously cold surroundings or when the room temperature rises sharply, condensation may form inside, and the unit may not be able to attain its full performance. To prevent this, allow the unit to stand for about an hour before switching it on, or raise the room temperature gradually.

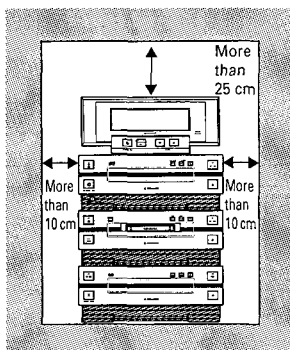

PRECAUTIONS REGARDING INSTALLATION

- Placing and using the unit for long periods on heat-generating sources will affect performance. Avoid placing the unit on heat-generating sources.
- Install this unit as far away as possible from TV sets. A unit installed in close proximity to such equipment may cause noise or degradation of the picture.
- Such noise may be particularly noticeable when an indoor antenna is used. In such a case, make use of an outdoor antenna, or turn off power to the unit.
- **Please place this unit on a level surface.**

VENTILATION

There is a cooling fan in the rear of this unit. If the exhaust vent is blocked, heat will build up inside, interfering with performance or causing malfunctions. Therefore, make sure to leave space between the unit and walls and other equipment to improve heat radiation (at least 25 cm at top 15 cm at rear 10 cm at left side, and 10 cm on right side (looking from the front)).

- Do not place on a thick carpet, bed, sofa, or fabric having a thick pile. Do not cover with fabric or other covering. Anything that blocks ventilation will cause internal temperature to rise, which may lead to breakdown or fire hazard.

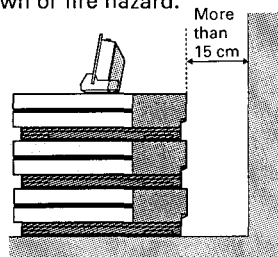

CONTENTS

CAUTIONS REGARDING HANDLING	2	RDS (Radio Data System)	
CONFIRM SUPPLIED ACCESSORIES	3	BROADCAST RECEPTION	27
INSERTING AND REMOVING THE REMOTE CONTROL UNIT HOLDER	4	RDS SELECTION AND DISPLAY	29
INSERTING A BATTERY INTO THE REMOTE CONTROL UNIT	4	SEARCHING FOR A DESIRED PROGRAM BY PROGRAM TYPE (Program Type Search)	30
REMOTE CONTROL OPERATIONS	4	CONVENIENT CD FUNCTIONS	31
INSTALLATION	5	REPEAT PLAY	31
CONNECTIONS	6	PROGRAMMED PLAY	32
PANEL FACILITIES	10	RANDOM PLAY	34
TURNING ON THE POWER	14	TO CHANGE DISPLAY MODES (WITH CD FUNCTION MODE)	34
DIRECT POWER ON	14	CONVENIENT TAPE FUNCTIONS	35
SETTING THE CLOCK	15	SYNCHRO RECORDING (CD→TAPE)	35
LISTENING TO A RADIO BROADCAST	16	SYNCHRO RECORDING (MD→TAPE)	37
LISTENING TO A COMPACT DISC	17	PARALLEL SYNCHRO RECORDING (CD→MD & TAPE)	38
TO PLAY A COMPACT DISC	17	TO CHANGE DISPLAY MODES (WITH TAPE FUNCTION MODE)	39
PLAYING A CASSETTE TAPE	18	USING THE TIMER	40
BASIC OPERATIONS	18	WAKE-UP TIMER	40
TO RESET THE TAPE COUNTER TO 0000	19	UNACCOMPANIED RECORDING (TIMER RECORDING)	42
TO SEARCH FOR A PARTICULAR TRACK (MUSIC SEARCH)	20	SLEEP TIMER	45
CAUTIONS REGARDING COMPACT DISC HANDLING	21	ADJUSTING TONE AND BALANCE	46
HOW TO HANDLE CASSETTE TAPES	21	ADJUSTING HIGH AND LOW FREQUENCY RANGES (TONE CONTROL)	46
RECORDING ON A CASSETTE TAPE	22	TO ADJUST THE RIGHT-LEFT BALANCE	46
BASIC OPERATIONS	22	TO ADJUST THE WOOFER LEVEL	47
STATION MEMORY (RADIO BROADCAST)	23	MAINTENANCE	47
TO RECORD A STATION NAME (STATION NAME FUNCTION)	24	TROUBLESHOOTING	48
STATION CALL	26	SPECIFICATIONS	50
TO CHANGE DISPLAY MODES (WITH TUNER FUNCTION MODE)	26		

CONFIRM SUPPLIED ACCESSORIES

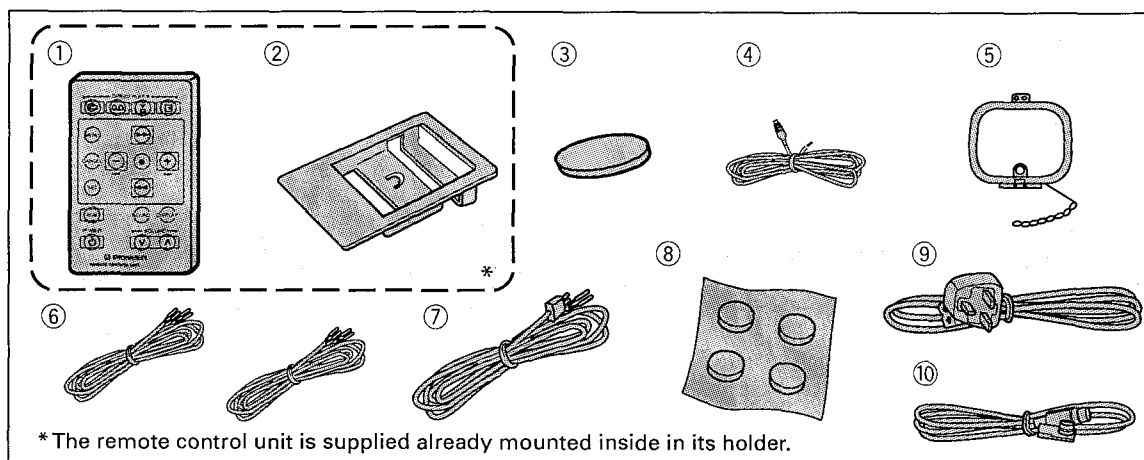

- ① Remote control unit x 1
- ② Remote control unit holder x 1
- ③ Lithium battery (CR2025) x 1
- ④ FM antenna x 1
- ⑤ AM loop antenna (shown assembled) x 1
- ⑥ Satellite speaker cords (included with speaker system) x 2
- ⑦ Subwoofer speaker cord (included with speaker system) x 1
- ⑧ Subwoofer's non skid pads (included with speaker system) x 4
- ⑨ Power cord x 1
- ⑩ Display unit cord (10p mini-DIN cable) x 1
- Operating instructions x 1
- Warranty card x 1

INSERTING AND REMOVING THE REMOTE CONTROL UNIT HOLDER

- Be sure to first remove the remote control unit from its holder and load batteries (see accompanying illustration).

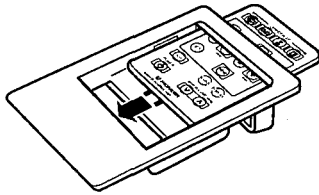

(To insert)

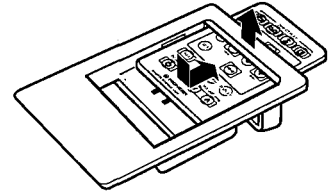
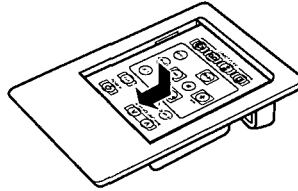

(To remove)

INSERTING A BATTERY INTO THE REMOTE CONTROL UNIT

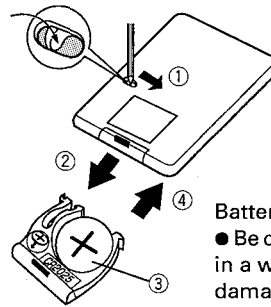

Battery holder Caution

- Be careful never to insert the battery holder in a wrong orientation, for this will result in damage.

- ① Insert a pencil or other similar pointed object into the place marked → and slide to the right, leaving in that position.
- ② Pull out the battery holder.
- ③ Insert the lithium battery (CR2025), aligning the ⊕ and ⊖ polarities correctly.
- ④ Reinsert the battery holder.

Incorrect use of battery may cause leakage or rupture. Always be sure to follow this guideline:

- A. Always insert the battery into the battery compartment correctly matching the positive ⊕ and negative ⊖ polarities, as shown by the display inside the compartment.
- B. Keep the lithium battery out of reach of children.
- C. If somebody swallows the lithium battery, immediately call your doctor.
- D. Do not attempt to open, recharge, heat, solder or short the battery or dispose it in fire.

REMOTE CONTROL OPERATIONS

The remote control unit can be used within a range of approx. 7 meters from the remote sensor, and within angles of up to approx. 30 degrees.

- If the remote control sensor window is in a position where it receives strong light such as sunlight or fluorescent light, control may not be possible.

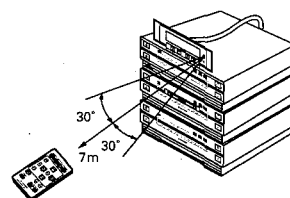

INSTALLATION

In order to obtain optimum performance from your system, it should be installed as shown in the accompanying illustration. When a MD recorder is included as part of the system, place it between the CD receiver and the cassette deck, as shown.

This product has been treated with a glossy finish. As a result, if the components are allowed to remain stacked for long periods of time, the feet of a unit above may leave imprints on the top of the unit below.

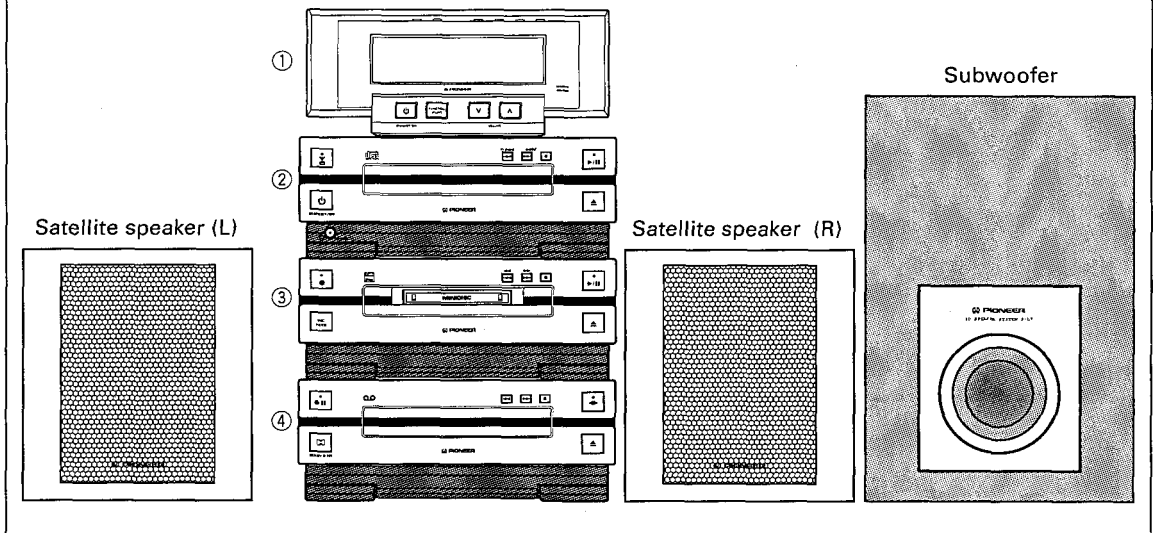

- ① Display Unit DU-L7
- ② Stereo CD Receiver XC-L7
- ③ MiniDisc Recorder MJ-L7 (sold separately)
- ④ Stereo Cassette Deck CT-L7 (sold separately)

■ Precautions regarding speaker placement

- Avoid installing speakers in places exposed to direct sunlight or near heating appliances, since the speaker cabinets may become deformed or discolored, or the speakers may be otherwise damaged.
- Never install speakers in unstable locations, since they may fall and cause personal injuries or other damage.

■ About the Subwoofer's non skid Pads

The speaker system's outer package contains non skid pads for the subwoofer. Apply these pads to the four corners of the subwoofer's bottom surface. It is particularly important to attach these pads when mounting the subwoofer on a hard floor or other slick surface.

CONNECTIONS

Before making or changing the connections, switch off the power and disconnect the power cord from the AC outlet.

- Be sure to connect an antenna. If you do not, broadcast signal reception will not be possible.

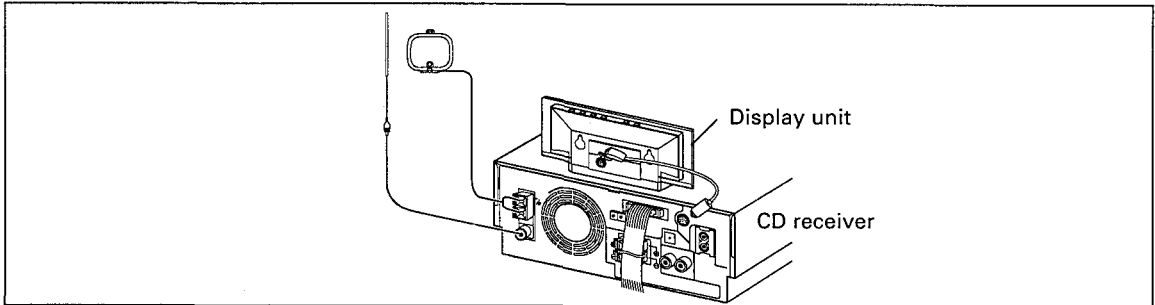

1 ANTENNA CONNECTIONS

① Connecting the AM and FM antennas.

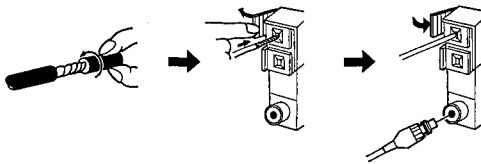

② Setting up the AM antenna.

There are three ways of setting the AM antenna. (See illustrations a, b and c)

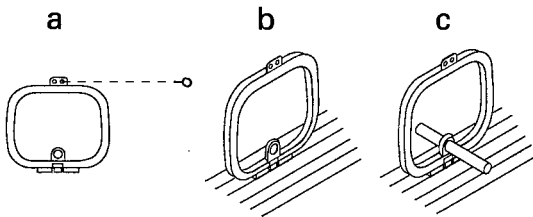

- Place the AM antenna on a flat surface and point it in the direction which yields the best reception.
- To prevent the generation of unwanted noise, locate the antenna at a distance from the system components and display unit, in a place where it does not come into contact with metal objects. Place it as far away from a personal computer, TV set, etc. as possible. Otherwise, noise may result.
- When the antenna is to be mounted on a wall, determine exactly where it should be positioned by finding the direction in which the best reception is yielded.

③ Mounting the FM antenna.

- Extend the FM antenna so that it is stretched out tautly. Do not allow it to hang loose or leave it coiled up.
- The FM antenna serves as a simple and convenient means of receiving FM stations. For better reception, use a dedicated FM antenna.

When reception quality is insufficient with the supplied antennas

- Purchase and connect outdoor AM and FM antennas (available commercially).

Connecting an external AM antenna

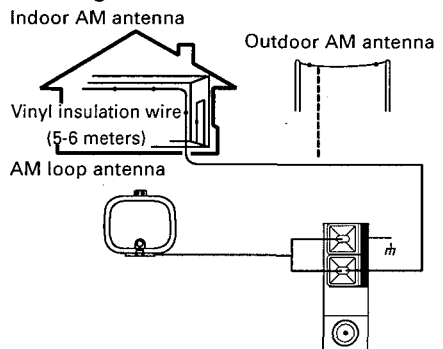

Do not disconnect the AM loop antenna, even when a separate AM antenna is connected.

Connecting an outdoor FM antenna

Connect as shown.

Using a coaxial cable

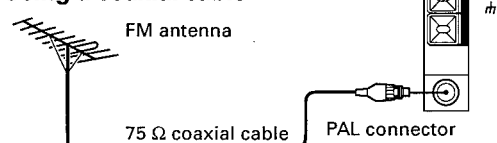

NOTE:

A signal earth (⊕) is designed to reduce noise that occurs when an antenna is connected. It is not a safety earth.

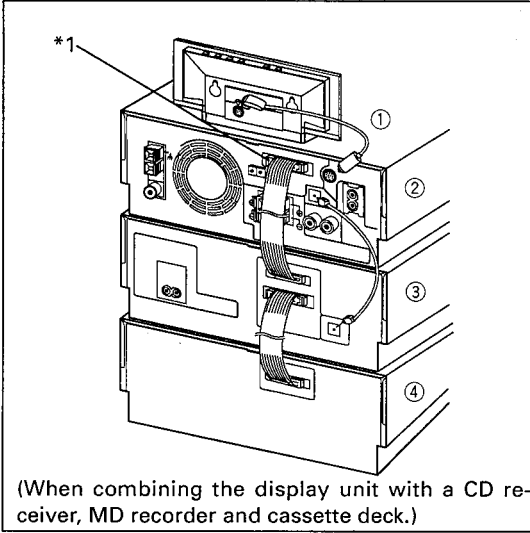

*1: This MUST be connected to the CD receiver.

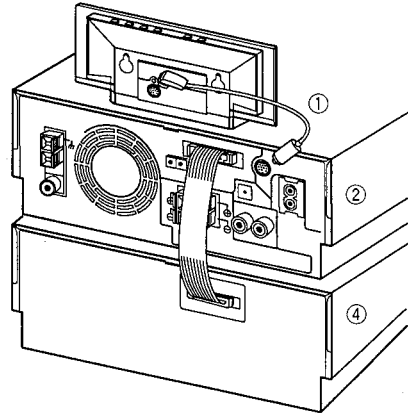

2 CONNECTING THE SYSTEM CABLES AND DISPLAY UNIT CORD

④ Connecting the system cables.

- ① Display Unit DU-L7
- ② Stereo CD Receiver XC-L7
- ③ Optional MiniDisc Recorder MJ-L7
- ④ Optional Stereo Cassette Deck CT-L7

To insert

Hold the connector, then press in firmly until a click is heard.

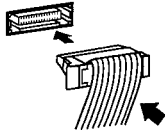

To remove

Hold the connector securely on both sides and pull out.

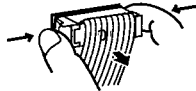

NOTE:

Do NOT connect or disconnect the system cables while the power plug is still connected to a power outlet. Failure to heed this warning may result in a breakdown.

Connect the inputs and outputs of the system cables so that the components are connected like beads on a string.

- The components may be connected in any order.

[Connections for the CD receiver, MD recorder and cassette deck]

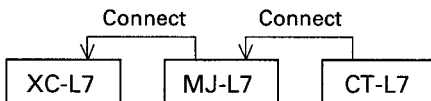

[Connections for the CD receiver and cassette deck]

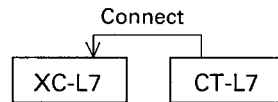

⑤ Connecting the display unit cord

Use the display unit cord to connect the display unit to the CD receiver's DU-L7 connector.

- The rear panel of the display unit is provided with two hook holes, allowing the unit to be mounted on a wall or other secure vertical surface.

NOTES:

- When using the display unit in a wall-mounted location, take full precautions to prevent the unit from accidentally falling.
- Screws and other fixtures for use in wall mounting are not included.

Pioneer bears no responsibility for accidents resulting from faulty assembly or installation, insufficient mounting strength of walls or other building fixtures, misuse or natural disasters.

The L-type connector is attached to the display unit.

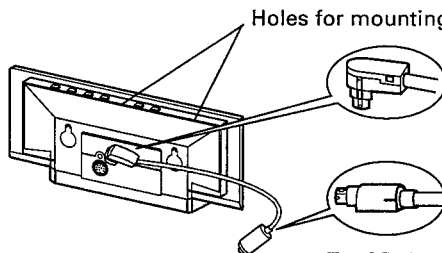

To CD Receiver XC-L7's dedicated DU-L7 connector.

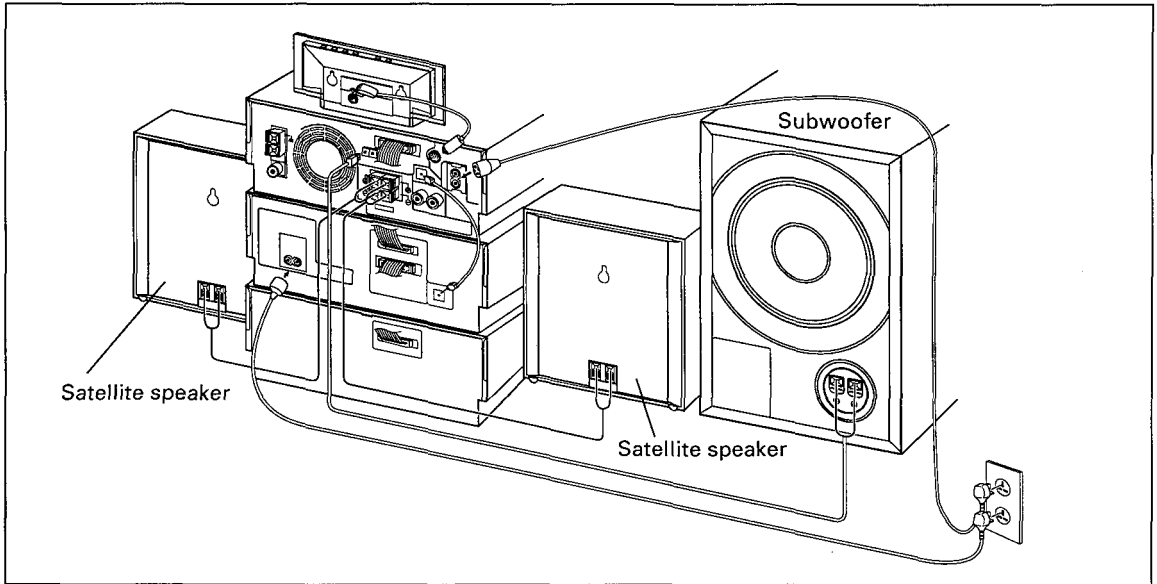

3 CONNECTING THE SPEAKERS AND POWER CORDS

⑥ Connect the speaker cords to the SPEAKER terminals. (Satellite Speaker S-L7-LR/S-L7-A-LR)

Connect the white cords (with gray line) to the “+” (red) terminals and the black cords to the “-” (black) terminals.

Connect the cords to the speakers in nearly the same way.

- ① **Twist the wire strands.**
- ② **Push away the tab and insert the cord into the terminal.**
- ③ **Pull back the tab. Be sure to tighten the cords firmly.**

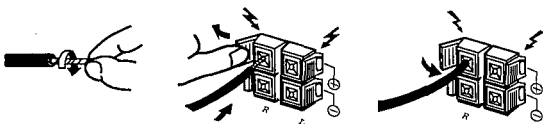

NOTE:

Do not allow the conductors of the cords to project out of the terminals or to come into contact with other conductors. A breakdown or failure may occur when conductors touch.

Speaker impedance

Connect speaker systems with a nominal impedance ranging from 6 Ω to 16 Ω (4 Ω in the case of sub-woofers).

Precautions for the S-L7-LR/S-L7-A-LR and S-L7-W/S-L7-A-W

- Do not connect to any amplifier other than the one supplied with this system. Connection to any other amplifier may in rare cases result in smoke or fire.
- Be careful not to block the port opening on the front panel of the speaker.

- Be very careful when connecting speaker cords! If one of the satellite speakers is mistakenly connected to the subwoofer’s speaker cord and connector, the satellite speaker may be damaged.
- This speaker system is not magnetically shielded, and may cause color noise or distortion when placed very near a television. If this occurs, place the speakers farther away from the television set.

⑦ Connect the speaker cords to the speaker terminals (SUBWOOFER S-L7-W/S-L7-A-W)

- ① Align the cord’s socket properly with the terminal and insert into the receptacle. To release the socket, pinch the top and bottom halves and pull out.
- ② On the end of the cord not provided with a socket, twist the insulation tips and pull off, exposing the wire.
- ③ Press down the tabs and insert the cords’ wire tips fully into the connectors.
- ④ Press up on the connector tabs, returning them to their original positions, and confirm that the cords are firmly fixed in place.

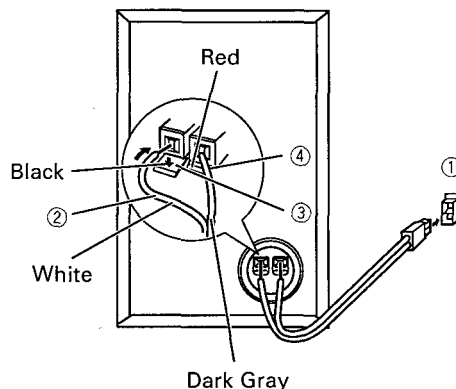

⑧ **Connecting the power cord.**

(When not using the optional MD recorder)

Insert the connector plug on the accessory power cord into the CD receiver's power inlet, and the other end into a household power outlet.

(When using the optional MD recorder)

① Insert the connector plug on the accessory power cord (furnished with the MD recorder) into the power inlet on the MD recorder, and the other end into an AC wall socket.

② Using the accessory power cord furnished with the CD receiver, insert the connector plug into the CD receiver's power inlet, and the other end into an AC wall socket.

NOTE:

The power plug on the CD receiver **MUST** be connected to an AC wall socket.

Satellite Speaker Placement

- The ideal listening position is at the apex, or slightly behind the apex, of an equilateral triangle whose base is formed by the line between the two satellite speakers.

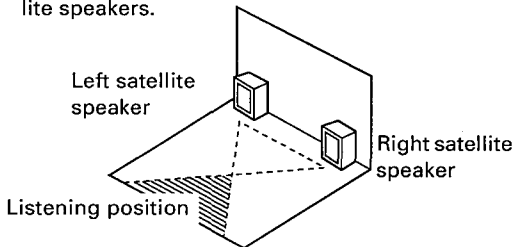

The satellite speakers can be mounted on a wall if desired.

- When using the satellite speakers in a wall-mounted installation, be very careful to avoid accidents resulting from falling speakers.
 - Check the wall before mounting and confirm that the wall or other surface is able to safely support the weight of the speakers. Pioneer bears no responsibility for accidents resulting from falling speakers due to insufficient wall strength or faulty installation.
- * Screws and other mounting fixtures for wall installation are not included.

Pioneer bears no responsibility for accidents resulting from faulty assembly or installation, insufficient mounting strength of walls or other building fixtures, misuse, or natural disasters.

Subwoofer Placement

- The subwoofer's 3D sound dispersion design allows a relatively high degree of freedom in placement.
- After placing the speaker, try playing some music and adjust the volume level as desired (see P. 47).
- A speaker is attached on the rear side of the subwoofer system. When installing or moving the subwoofer, take care not to touch this speaker unit, since sound distortion or speaker damage could result.

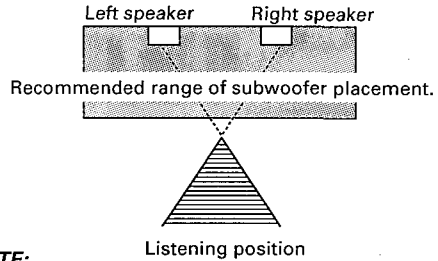

NOTE:

- If the speakers are placed too far apart, the desired sound effect will not be achieved (out of the adjustment range.)
- When installing the subwoofer, the rear surface of the speaker should be located no closer than 5cm from a wall. Mounting the subwoofer flush against a wall will impair speaker performance and could result in distorted sound.

CONNECTING AN ADDITIONAL EXTERNAL COMPONENT

(such as a VCR or DAT recorder other than the component in this system)

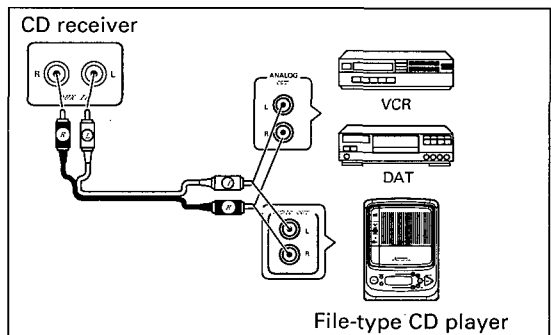

- Connect the output connectors of the additional component to the input (AUX) connectors of the CD receiver. (Use a commercially available pin-plug connection cord.)
- To listen to the component connected to the input (AUX) connectors, use the display unit's function button (or the AUX button on the remote control unit) to select AUX, then operate the component to begin playback.
- For details of operation, consult the operating instructions furnished with the component used.
- When using a Pioneer file-type CD player: This CD receiver is not equipped with a control cord connector. As a result, a file-type CD player cannot be operated by pointing its remote control unit at the display unit's remote sensor.

When adding the optional MiniDisc Recorder (MJ-L7) to the system, be sure to connect the digital (fiber-optic) cable furnished with the MD recorder. Connect the cable between the CD receiver's digital output connector and the MD recorder's digital input connector. If this cable is not connected, the MD recorder will be unable to enter the recording pause mode, thus making parallel synchro recording impossible (see P. 38).

PANEL FACILITIES

STEREO CD RECEIVER XC-L7

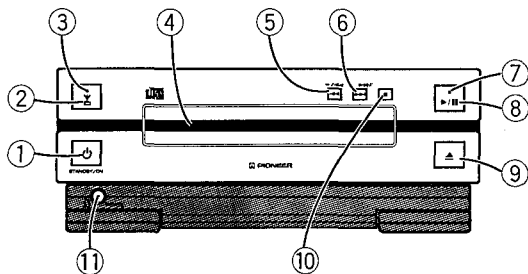

STEREO CASSETTE DECK CT-L7

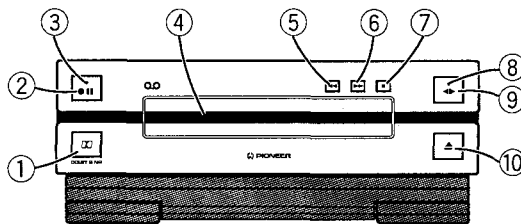

STEREO CD RECEIVER XC-L7

- ① POWER, STANDBY/ON switch (☞ P. 14)
- ② FM/AM/station button (☞ P. 16, P. 24)
- ③ Tuner indicator
- ④ CD tray
- ⑤ button (☞ P. 15, P. 16)
- ⑥ button (☞ P. 15, P. 16)
- Roles of common operation buttons vary depending on the input function currently selected, as follows:

During Tuner Operation

- : Frequency and station - (down) button.
- : Frequency and station + (up) button.

During CD Operation

- : Fast reverse/track search button.
- : Fast forward/track search button.

- ⑦ Playback indicator
- ⑧ CD Play/Pause button
- ⑨ CD tray Open/Close button (▲)
- ⑩ CD stop button (■).
- ⑪ PHONES jack

For use with headphones equipped with a stereo miniplug. When headphones are connected, sound to the speakers is disabled.

STEREO CASSETTE DECK CT-L7

- ① DOLBY * B NR (Dolby B-type NR ON/OFF) button (☞ P. 18)
- ② Recording pause button (● II) (☞ P. 22)
- ③ Rec indicator
- ④ Cassette tray
- ⑤ Rewind button (◀◀)
- ⑥ Fast forward button (▶▶)
- ⑦ Stop button (■)
- ⑧ Playback indicator
- ⑨ Play/Direction select button (☞ P. 19)
- ⑩ Cassette tray Open/Close button (▲)

*

- Dolby noise reduction manufactured under license from Dolby Laboratories Licensing Corporation.
- "DOLBY" and the double-D symbol are trademarks of Dolby Laboratories Licensing Corporation.

DISPLAY UNIT DU-L7

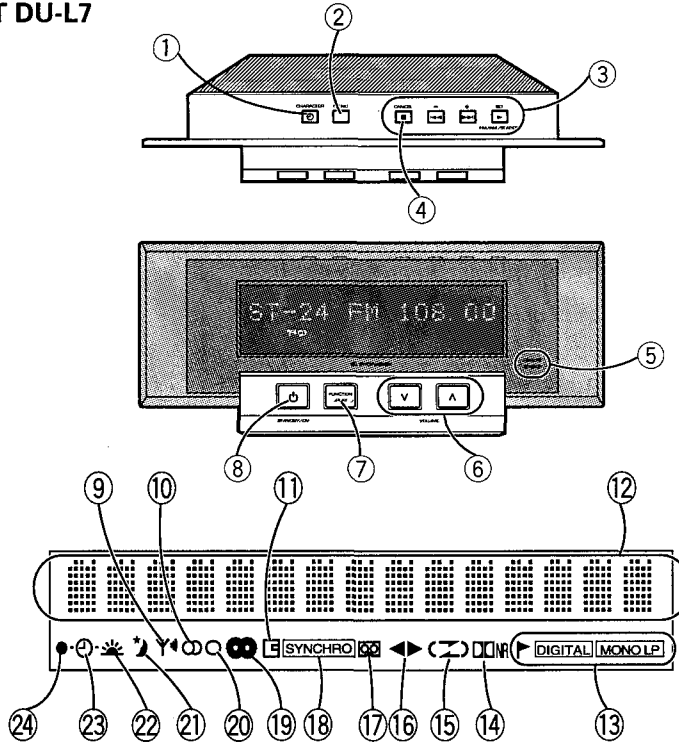

DISPLAY UNIT DU-L7

- ① CHARACTER/Timer button (☞ P. 24, P. 40)
- ② MENU button (☞ P. 16, P. 18)
- ③ buttons
FM/AM/STATION
- Roles of common operation buttons vary depending on the input function currently selected, ☞ P. 12.
- ④ CANCEL/Stop button
- ⑤ REMOTE SENSOR
- ⑥ VOLUME ^ (UP), v (DOWN) buttons
- ⑦ FUNCTION button (☞ P. 18)
- ⑧ POWER STANDBY/ON switch (☞ P. 14)

[DISPLAY SECTION]

- ⑨ Lights when station is tuned.
- ⑩ Lights when receiving a stereo broadcast.
- ⑪ Lights during MD recording; flashes during recording pause mode.
- ⑫ Shows station frequencies and main operating conditions.

- ⑬ These indicators are used when the optional MiniDisc Recorder MJ-L7 is added as part of the system. For details, consult the Operating Instructions accompanying the MJ-L7.
- ⑭ Lights when Dolby *NR is ON.
- ⑮ Indicates reverse mode.
- ⑯ Indicates direction of tape travel on cassette deck.
- ⑰ Lights during tape recording (flashes during recording pause mode).
- ⑱ Lights during synchro-recording standby and operation modes.
- ⑲ The RDS indicator will light in the RDS mode
- ⑳ Lights during monaural mode.
- ㉑ Lights during setting and operation of the sleep timer.
- ㉒ Lights during wake-up timer setting mode; flashes during operation.
- ㉓ Lights during setting and operation of the recording timer and wake-up timer.
- ㉔ Lights during recording timer setting mode; flashes during operation.

PANEL FACILITIES

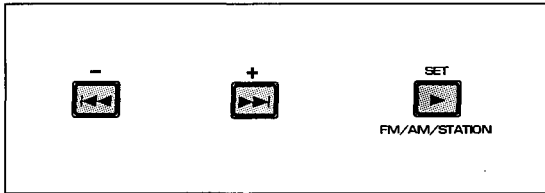

DISPLAY UNIT DU-L7: Roles of common operation buttons vary depending on the input function currently selected, as follows:

During Tuner Operation

- : Frequency and station - (down) button.
- : Frequency and station + (up) button.
- : FM/AM/STATION button.

During CD Operation

- : Reverse track search button.
- : Forward track search button.
- : Play/Pause button.

During Tape Operation

- : Rewind/Reverse music search button.
- : Fast forward/Forward music search button.
- : Play/Direction button.

During MD Operation

- : Reverse track search button.
- : Forward track search button.
- : Play/Pause button.

During MENU/timer operation mode

- : Minus button.
- : Plus button.
- : SET button.

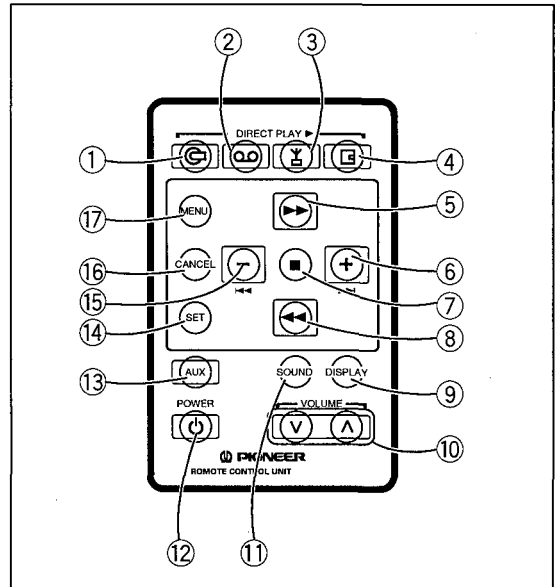

REMOTE CONTROL UNIT

- ① CD Play/Pause button
- ② Tape Play/Direction button
- ③ FM/AM/Station button
- ④ MD Play/Pause button
- ⑤ button
- ⑥ button
- ⑦ button
- ⑧ button
- ⑨ DISPLAY button (see P. 26, P. 34, P. 39)
- ⑩ VOLUME \wedge (UP), \vee (DOWN) buttons
- ⑪ SOUND button (see P. 46, P. 47)
Each time this button is pressed, the sound mode changes in the following sequence:
- ⑫ POWER button (POWER STANDBY/ON)
- ⑬ AUX function button
- ⑭ SET button (see P. 15, P. 18)

⑮  button

⑯ CANCEL button (see P. 18)

⑰ MENU button (see P. 16, P. 18)

- Roles of buttons ⑤, ⑥, ⑦, ⑧, and ⑮ vary depending on the input function currently selected, as follows:

During Tuner Operation

 : Station + (up) button

 : Station - (down) button

 : Frequency up button

 : Frequency down button

During CD Operation

 : Forward track search button

 : Reverse track search button

 : Stop button

 : Fast forward (manual search) button

 : Fast reverse (manual search) button

During Tape Operation

 : Fast forward button

 : Rewind button

 : Stop button

 : Forward music search button

 : Reverse music search button

During MENU mode Operation

 : Plus button

 : Minus button

 : Cursor movement (during character input)

 : Cursor movement (during character input)

During MD Operation

 : Forward track search button

 : Reverse track search button

 : Stop button

 : Fast forward (manual search) button

 : Fast reverse (manual search) button

TURNING ON THE POWER

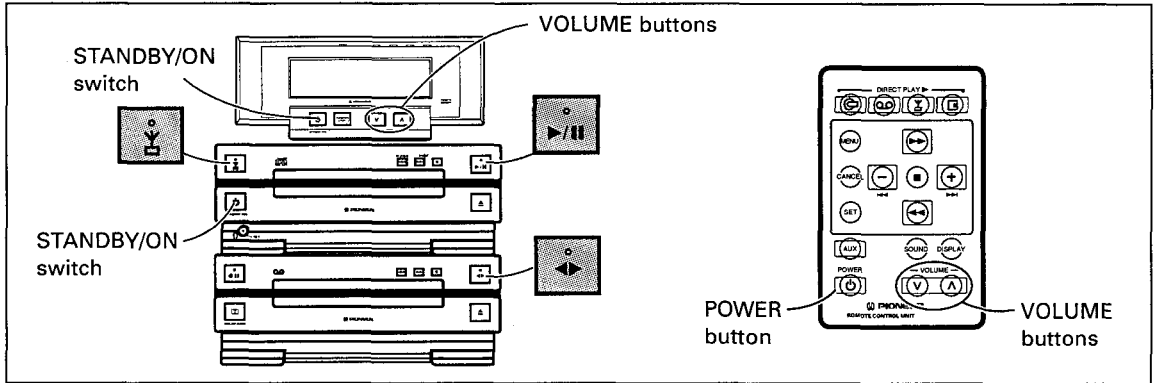

Operations indicated by the () mark are performed with the remote control unit.

- Before turning on the power, please review the "CONNECTIONS" section and confirm that the speakers, antenna, and other components have been connected properly.
- When the power plug is connected into an AC wall outlet, the unit enters the demonstration mode. Press the STANDBY/ON switch to cancel the demonstration mode.

1. Press the **STANDBY/ON switch (or POWER button on the remote control unit)**.
The volume level is displayed.

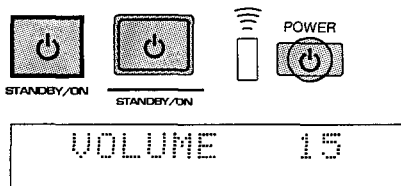

- To turn the power off:
Press the CD receiver's STANDBY/ON switch or Display unit's STANDBY/ON switch again.



The display will change to the current time, and the dimmer function will operate, causing the display to be dimmed (if the clock time has not been set, the display will flash).

Auto Play MD Loading















If a playback-only MD is inserted into the slot when power is turned off, power will be turned on and playback will begin automatically.

Power-Off CD/Tape Eject

If the CD tray open/close button or cassette tray open/close button is pressed when the power is turned off, the power will turn on and the CD tray will open (in the case of the CD receiver) or the cassette tray will open (in the case of the cassette deck).

DIRECT POWER ON

Power can also be turned on by pressing one of the following buttons.

Tuner:				Power turns on, radio turns on and play begins.
CD:				If a CD is loaded, power turns on and play begins.
TAPE:				If a cassette tape is loaded, power turns on and playback begins.
MD:				If an MD is loaded, power turns on and play begins.
AUX:				If the component connected to the external input connectors (AUX) is operating, the sound from that component will be heard.

- When an MD recorder is connected, changes alternately between AUX (digital) and AUX.

Function AutoPlay

When the CD, Tape, or MD function is selected on the display unit, playback will begin automatically (assuming that the appropriate playback disc or tape has been loaded in the respective component; also, playback will not begin if the tape deck or MD recorder is set to the recording pause mode).





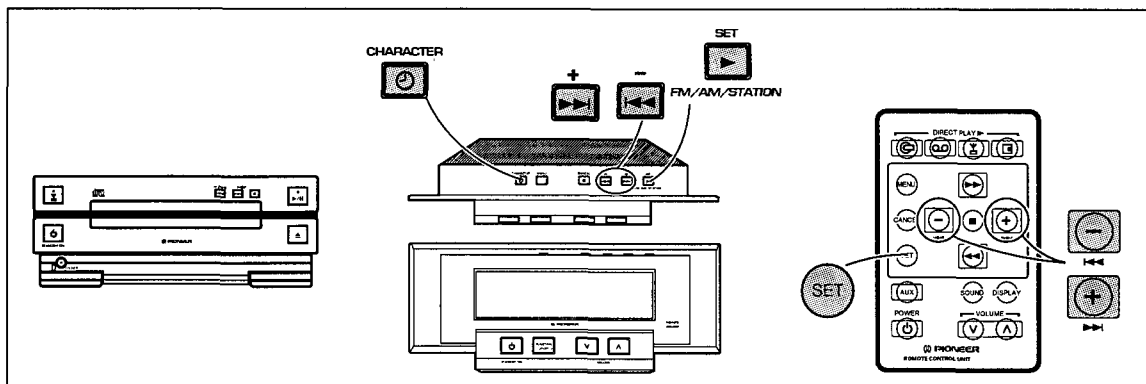

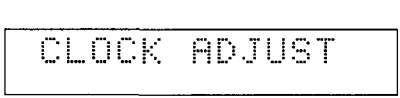
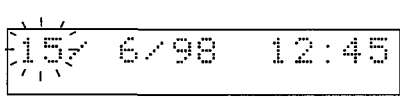
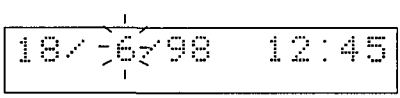
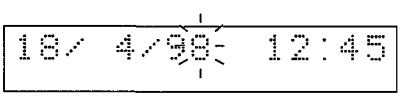
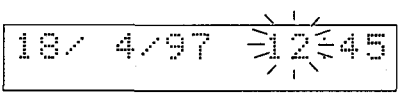
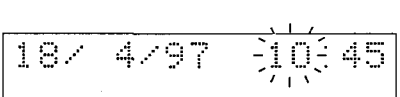
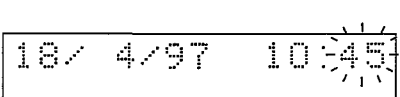
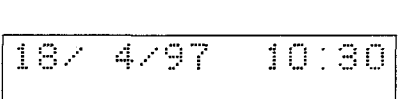







SETTING THE CLOCK



1	
2	
3	
5	
7	
9	
10	
11	
13	

- This clock provides a 24-hour display.
- The remote control unit cannot be used to set the clock.

Example: To set the clock to 10:30 (A.M.), April 18, 1997.

1. Press the **CHARACTER/Timer** button.
2. Use the  and  buttons to select "CLOCK ADJUST".
3. Press the **SET** button.
4. Use the  and  buttons to set the day to "18."
5. Press the **SET** button.
6. Use the  and  buttons to set the month to "4."
7. Press the **SET** button.
8. Use the  and  buttons to set the year to "97."
9. Press the **SET** button.
10. Use the  and  buttons to set the hour to "10."
11. Press the **SET** button.
12. Use the  and  buttons to set the minutes to "30."
13. To start the clock operation, press the **SET** button.

- To set the clock most accurately, it is recommended to use your local telephone service's time signal.

NOTES:

- The timer functions will not operate if the clock has not been set properly to the current time.
- If the power source is disconnected or interrupted, the clock display will flash, to indicate that the correct time is no longer set. In this event, reset the clock to the correct current time.
- While playing components using the various functions, the remote control unit's **DISPLAY** button can be pressed to display the current clock time.
- The year can be set within the range 1997-2030.

LISTENING TO A RADIO BROADCAST

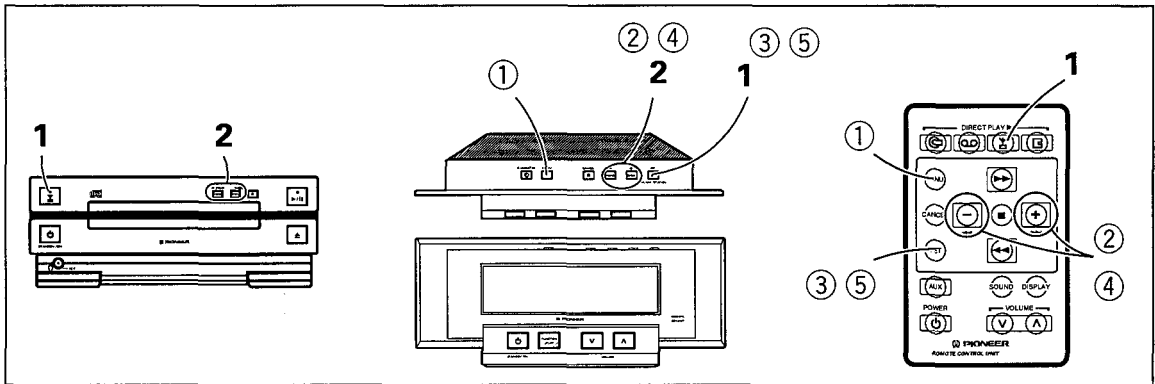

BROADCAST RECEPTION

- Do not place the AM antenna on a metallic case including the CD receiver cabinet or near a CD player, LD player, DAT recorder, personal computer or TV set. Any of these installations will cause noise in reception.
- Broadcast reception is not possible unless an antenna is connected, so be sure to connect one.

1. Press the FM/AM/STATION button to select either the FM or AM band.

Alternates when pressed FM → AM
STATION ←



2. Press the or button for lower or higher frequencies.

[Manual tuning]

Press the or button and release quickly. The tuning frequency will change by one step each time the button is pressed. Press as many times as necessary to tune in the desired station. The TUNED indicator () lights on the display unit when the station is turned in best.

[Auto tuning]

Press the or button until the frequency starts to change, then release it. The tuner will automatically search for a broadcasting station, stops when one is found and the TUNED indicator () lights on the display unit. To search for another station, press again.

- To interrupt auto tuning, press the or button again.

[High-speed manual tuning]

Press and hold the or button.

→ The frequency will change continuously and stop when you remove your finger from the button.

When a stereo broadcast is received, the stereo indicator () will light.

When the MONO indicator () lights, it means the currently received broadcast is being heard in monaural sound.

MONO Reception

If a stereo broadcast exhibits high levels of noise, use the following procedure to set to monaural reception. The sound from the speakers will no longer be heard in stereo, but the level of noise should be reduced.

① Press the MENU button.



② Use the buttons to select "FM AUTO/MONO."

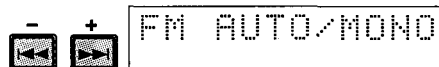

③ Press the SET button.



④ Use the buttons to select "MONO".

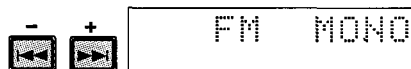

⑤ Press the SET button.

The MONO indicator () will light on the display unit.



NOTE:

Once the MONO mode has been set, it will remain set until manually changed. When you have finished listening to a broadcast with MONO set to ON, it is recommended to reset the reception mode to AUTO to allow stereo reception of subsequent broadcasts.

LISTENING TO A COMPACT DISC

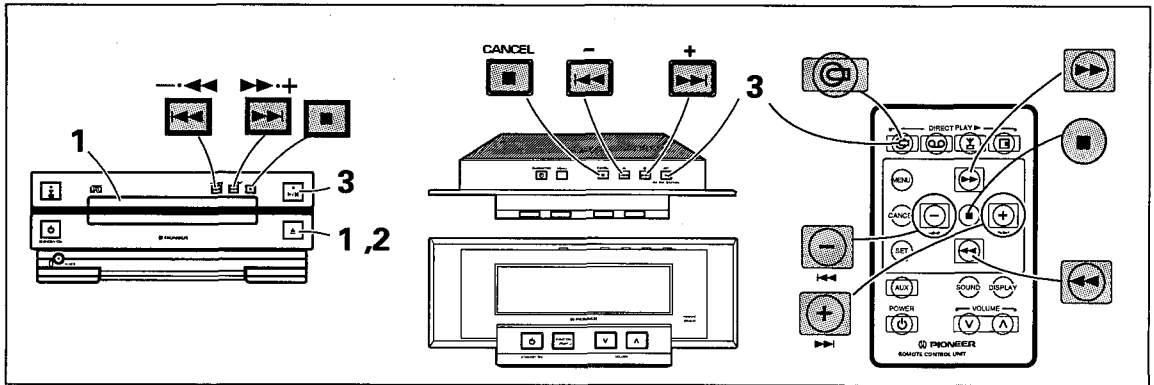

TO PLAY A COMPACT DISC

1. Press the open/close button and place a disc on the tray with its label surface facing up.

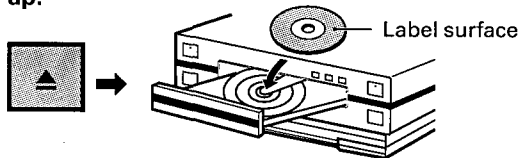

2. Press the open/close button to close the tray.
3. Press the CD play/pause button (or SET button on the display unit).



- Playback will start from the first track.
- The player will stop automatically when all tracks have been played.

■ To Stop Playback ■

Operation	Press this Button
Cancel playback	
Pause playback	Flashes
Resume playback from pause	Lights

■ To Play a Specific Track ■

Operation	Press this Button
To search for a track	 Press and release. ● If the button is pressed during the pause mode, playback will move to the selected track and remain paused there; to resume play, press the Play/Pause button (step 3).
Fast Forward / Fast Reverse	 Hold depressed.

NOTES:

- During fast forward/fast reverse, the sound will be attenuated, then return to its previous level when the operation ends.
- When loading 8cm discs, do not use an 8cm CD single adapter.
- Never attempt to load a 12cm disc simultaneously with an 8cm disc, since disc damage or other malfunctions may result. Always load only one disc at a time.

PLAYING A CASSETTE TAPE

(Are the heads clean? P. 47)

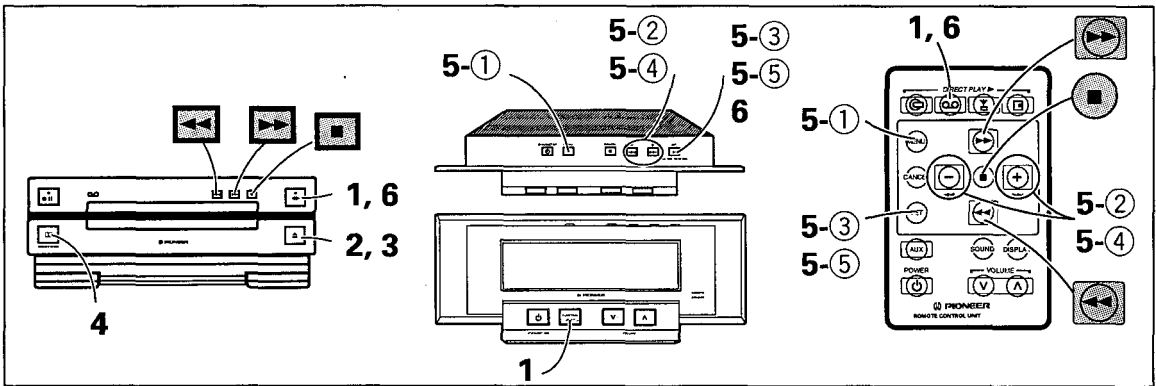

BASIC OPERATIONS

1. Press the play/direction button (or the display unit's FUNCTION button) and select "TAPE."



2. Press the open/close button (▲) and load a recorded tape.

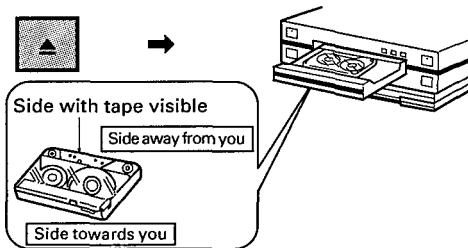

Be sure to insert the cassette in the direction shown. Inserting the cassette backwards will cause a malfunction or damage.

3. Press the open/close button to close the tray.



4. Set the Dolby NR to the same position used for recording.

Tapes recorded using Dolby noise reduction should always be played back with the noise reduction system turned ON. The NR system is turned ON and OFF alternately with each press of the button as shown.

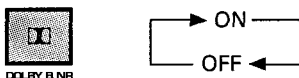

5. Select the reverse mode.

- ① Press the MENU button on the remote control unit or display unit.



- ② Use the -/+ buttons to select "REVERSE MODE."

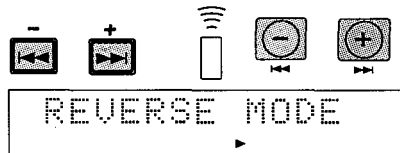

- ③ Press the SET button.



- ④ Use the -/+ buttons to select one of the three available reverse modes.

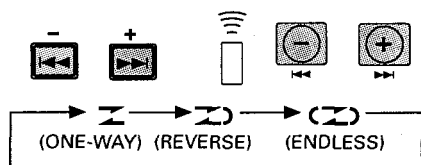

- ⑤ Press the SET button.



If you make a mistake, press the CANCEL button and start over.

- ☰: Single side play (playback stops after one side)
- ☷: Playback stops after completion of playback in the ◀ direction.
- ⌘: Continuous repeat playback of both sides, up to a maximum of 16 tape sides, after which the cassette deck stops automatically.

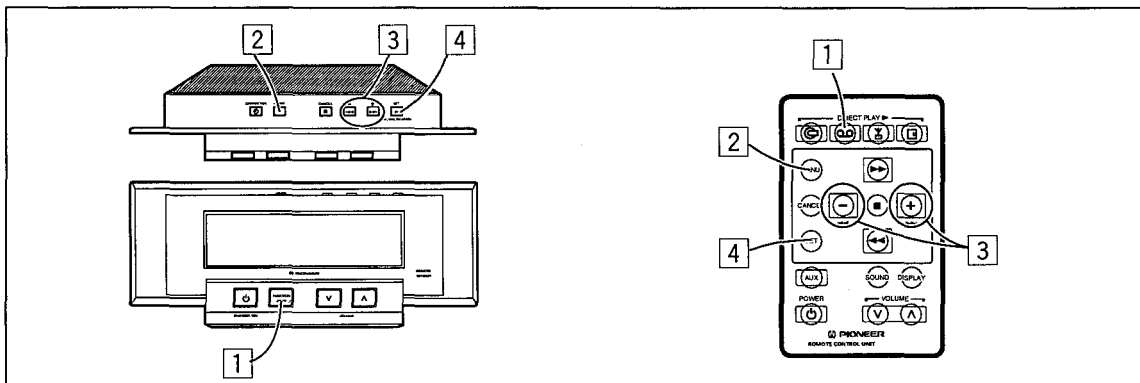

6. Press the play/direction button (or SET button on the display unit).



- The direction of tape travel will be displayed on the display unit; select the desired direction of travel by pressing the button.
- Each time the button is pressed, the direction of travel changes alternately to side A and side B as shown below:

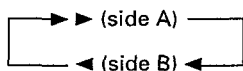

- When loading the cassette tape in the cassette tray, if the cassette is set with side A facing UP, the "forward" direction (▶) will correspond to side A and the "reverse" direction (◀) will correspond to side B.

Operation	Button to Press
To stop playback	
To fast forward or rewind the tape • Press when the tape is stopped.	

TO RESET THE TAPE COUNTER TO 0000

- 1 Set the unit to tape function mode.
- 2 Press the MENU button.



- 3 Use the and buttons to select "COUNTER RESET."

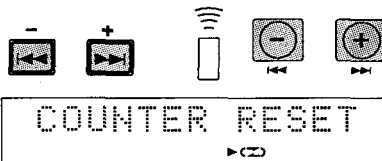

- 4 Press the SET button.



- The tape counter can also be reset by opening/closing the cassette tray.

PLAYING A CASSETTE TAPE

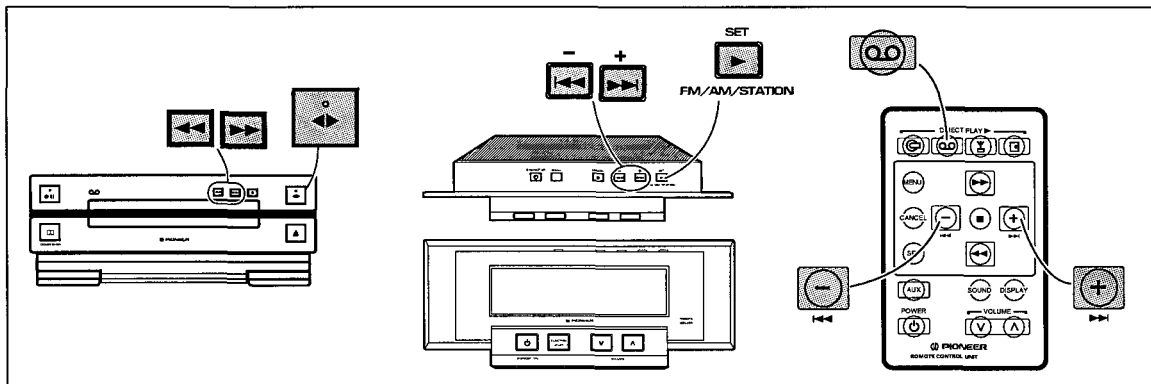

TO SEARCH FOR A PARTICULAR TRACK (MUSIC SEARCH)

While the cassette deck is in the playback mode, press either the fast forward or the rewind button.

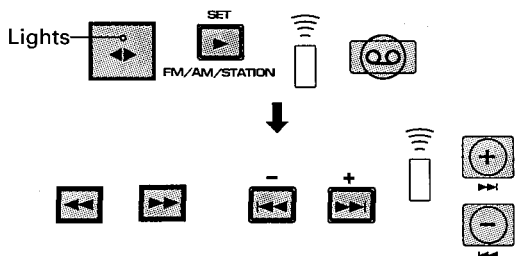

- When the remote control unit is used, music search can also be performed from the stop mode.
- Pressing ◀ will return the tape to the beginning of the currently playing track.
- Pressing ▶ will advance the tape to the beginning of the next track.

Pressing the buttons multiple times will advance or return the tape to tracks located farther away from the current track position (up to a maximum of 15 tracks in either direction from the current position).

Example: While playing track 3 in the ▶ direction:

If the ▶ button is pressed two times, the tape will advance to the beginning of track 5.



If the ◀ button is pressed two times, the tape will return to the beginning of track 2.

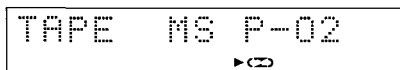

NOTE:

The music search function may not work correctly when the following tapes are being played back.

- Tapes that do not have unrecorded portions of 4 seconds or more between songs.
- Tapes containing music with long intervals of low sound such as classical music.
- Tapes with interruption of sound, such as meetings and language study tapes.
- Tapes containing noise in the unrecorded portions.

Auto Tape Selector

This function uses the tape-type detection holes located on the edge of the cassette to determine the type of tape used, and adjust the player automatically to the appropriate bias and equalization settings.

- (a) Erasure-prevention tabs
- (b) Tape-type detection holes

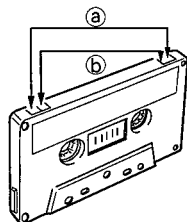

TYPE II (CrO₂/HIGH)

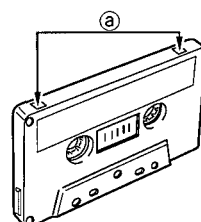

TYPE I (Normal)

NOTE:

When affixing labels to cassette tapes, do not superimpose one label on top of another. Apply only one label.

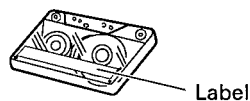

Label

CAUTIONS REGARDING COMPACT DISC HANDLING/ HOW TO HANDLE CASSETTE TAPES

CARE OF DISCS

- With this player, use discs which display the mark shown below. (Optical audio digital discs.)
- When holding discs, do not touch their signal surfaces. Hold by the edges, or by one edge and the center hole.
- Do not affix gummed labels or tape to the label surfaces. Also, do not scratch or damage the disc.
- Discs rotate at high speed inside the player. Do not use damaged (cracked or warped) discs.

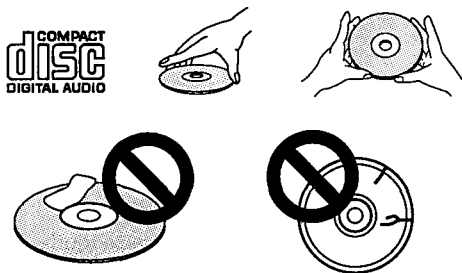

CLEANING DISCS

- Fingerprints or smudges on the surface of a disc will not directly affect the recorded signals, but depending on the degree of contamination, the brightness of the light reflected from the signal surfaces may be reduced, causing degradation of sound quality. Always keep your discs clean by wiping them gently with a soft cloth from the inner edge toward the outer periphery.
- If a disc becomes very dirty, dip a soft cloth in water, and after wringing it out well, wipe the dirt away gently. Remove any water drops with another soft, dry cloth.
- Do not use record cleaning sprays or anti-static agents on discs. Never clean discs with benzene, thinner, or other volatile solvents, since damage to the disc surface may result.



STORING DISCS

- Discs are made of the same kinds of plastic used for conventional analog audio records. Be careful not to allow discs to warp; always store discs in their cases vertically, avoiding locations with high heat or humidity, or extremely low temperatures. Avoid leaving discs in cars, since the seat of a car in direct sunlight can become extremely hot.
- Always read and abide by the precautionary notes listed on disc labels.

Is the tape loose, or is some of the tape sticking out of the cassette?

This will damage the tape itself. To remove the slack, insert a pencil into the spool and gently wind it.

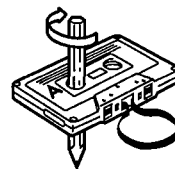

Safekeeping

Put the cassette tape back into its case and store it in a location not exposed to magnetic fields, humidity, dust, or oil.

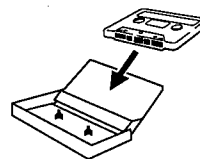

Tips on using cassette tapes

- Leader tape (which does not allow sound to be recorded over it) is provided at the beginning of a cassette tape. Start recording after allowing the tape to run for approx. 5 seconds so that the leader tape clears the recording head.
- Forwarding or reversing the cassette tapes before recording prevents damage to the unit caused by tape slack.

Do not use tapes longer than 90 minutes.

Since tapes longer than 90 minutes are so thin, they easily jam in the pinch roller and capstan, and they are susceptible to other trouble such as irregular winding. Try not to use them with this unit.

How can you prevent accidental erasure?

When the tab on the cassette shell is broken out with the tip of a screwdriver, it will not be possible to activate the recording function even by pressing the REC PAUSE button, so valuable recordings will not be erased in error.

When you want to record again on a cassette with bro-

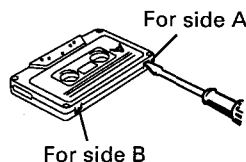

ken erasure prevention tabs, cover the hole with a double layer of adhesive tape.

With TYPE II (HIGH/CrO₂) tapes, be sure not to cover the tape-type detection holes.

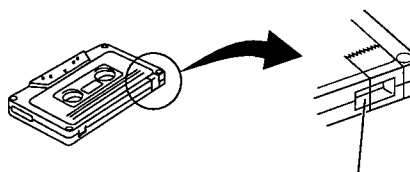

Be sure not to cover the tape-type detection holes.

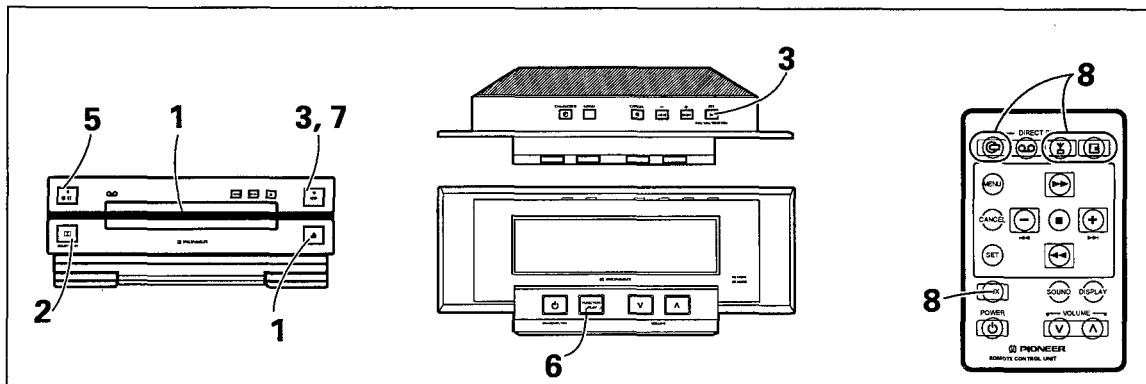

BASIC OPERATIONS

1. Insert a cassette tape.

- Forward the tape past its leader section to expose the tape's magnetic surface ([P. 21](#)).
- Recording cannot be performed if the cassette's erasure-prevention tabs have been broken.
- Use a Type I (normal) or Type II (High/CrO₂) tape. Type IV (Metal) tapes cannot be used.

2. Press the DOLBY B NR button to set the Dolby B noise reduction function to ON or OFF.

The noise reduction system is turned ON and OFF alternately with each press of the button as shown.

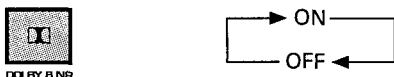

3. Press the play/direction button corresponding to the direction you wish to record.

The indicator in the display unit shows the direction.



Press the stop button (■) after selecting the recording direction.

- If the reverse direction (◀) is selected, recording will stop after completion of the recording of the cassette tape's reverse side.

4. Select the reverse mode.

For more details, [P. 18](#).

- ⏏: Recording stops after one side.
- ⏏, (▶): If recording is started from side A (▶ direction), recording continues to side B (◀ direction).

If recording is started from side B (◀ direction), recording stops after completion of recording on side B only.

5. Press the recording pause button.



The unit enters the recording pause mode.

6. Use the display unit to select the source function you wish to record.



When recording a radio broadcast from the tuner, tune in the desired station.

7. Press the play/direction button.

Recording begins, and the rec indicator lights steadily.

8. Press the SET button then begin playing the source component.



Stop recording:



Pause:

(During recording)



Recommence recording (after the recording pause button has been pressed):

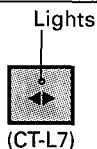

NOTES:

- The function setting cannot be changed during recording (it can be changed, however, during the recording pause mode).
- The setting of the tone control ([P. 46, 47](#)) has no effect on the recording.
- The recording level is automatically set by the unit's ALC (Auto Level Control) function.

STATION MEMORY (RADIO BROADCAST)

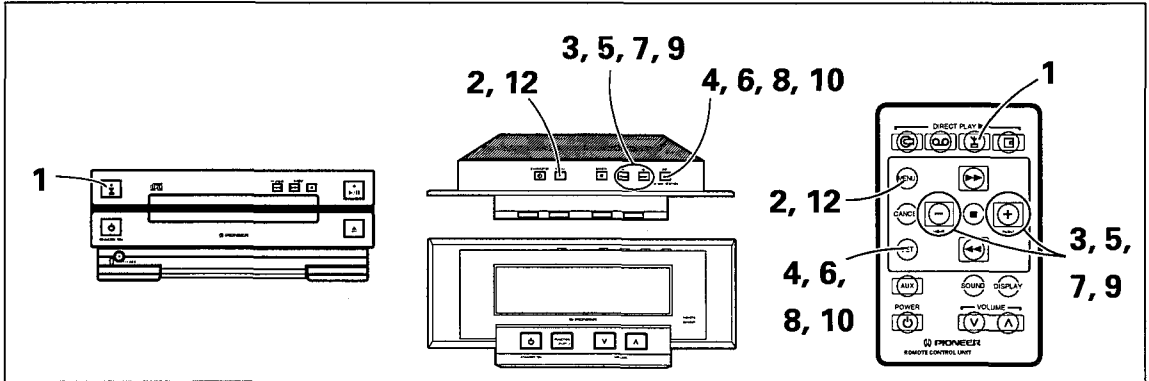

A total of 24 FM and AM stations can be stored in the unit's memory to allow convenient tuning of your favorite stations.

Example: To store a station broadcasting at 87.5 MHz in station memory 3.

1. Set the function to tuner.

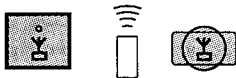

2. Press the MENU button.



3. Use the and buttons to select "STATION MEMORY."

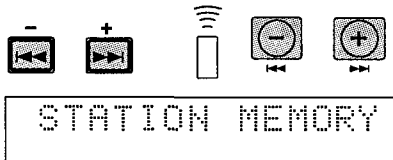

4. Press the SET button.



5. Use the and buttons to select the desired station memory position.

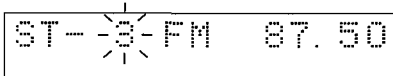

6. Press the SET button.



7. Use the and buttons to select AM or FM.

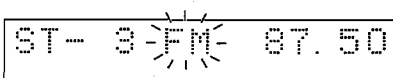

8. Press the SET button.



9. Use the and buttons to select the desired station frequency.

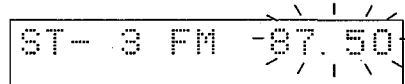

10. Press the SET button.



The display will flash two times to indicate completion of the memory process.

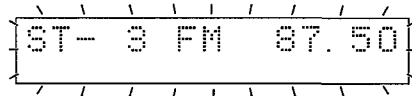

11. To store additional stations in memory, repeat steps 5 to 10.

12. Press the MENU button to leave the station input mode.



If you wish to cancel the setting operation midway, press the MENU button again.

NOTE:

If a radio station is stored in a memory position containing previously stored station information, the previous station's data will be overwritten by the new station data.

TO RECORD A STATION NAME (STATION NAME FUNCTION)

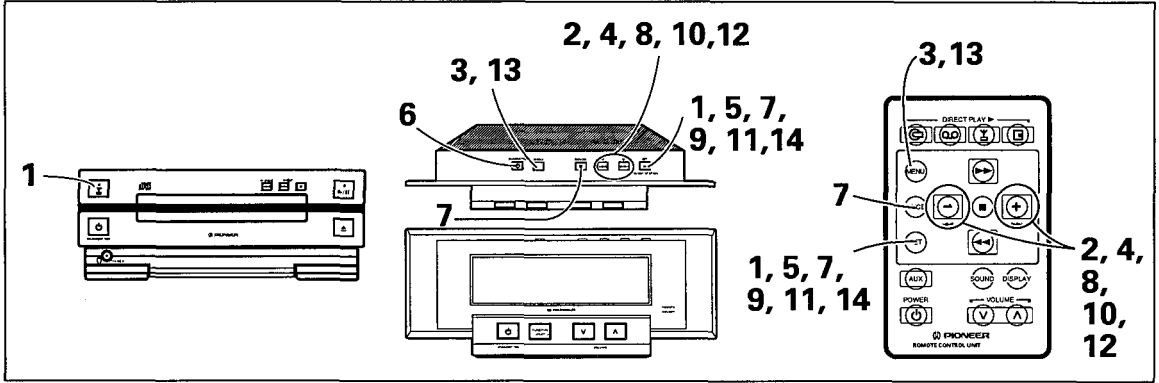

- Station numbers recorded in the station memory can be given names using up to 9 characters. Example: To record the name "BBC" for the station recorded in memory position 24.

1. Press the FM/AM/Station button to select the station display.

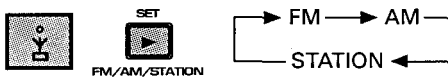

2. Use the and buttons to select the station position you wish to name.

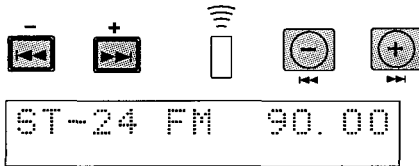

3. Press the MENU button.



4. Use the and buttons to select "STATION NAME".

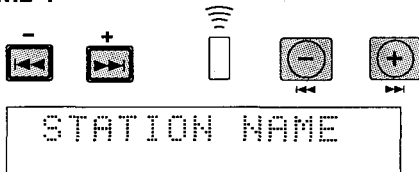

5. Press the SET button.

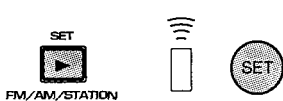

6. Press the CHARACTER button to select the type of character (each time the button is pressed, the character mode changes in the sequence shown):

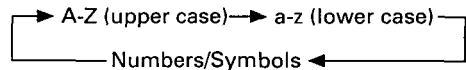

Types of characters that can be used with the Station Name function:

- Alphabet (upper case): ABCDEFGHIJKLMNOPQRSTUVWXYZ. , / □ (space)
- Alphabet (lower case): abcdefghijklmnopqrstuvwxyz. , / □ (space)
- Numbers/symbols: 0123456789!"#\$%&'()*+,-./:;<=>?@_`□ (space)

7. Use the CANCEL and SET buttons to move the cursor to the desired character position.

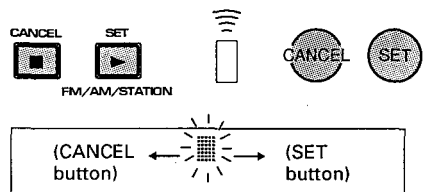

- When the CANCEL button is pressed, the cursor moves to the left.
- When the SET button is pressed, the cursor moves to the right.

8. Use the and buttons to select character "B."

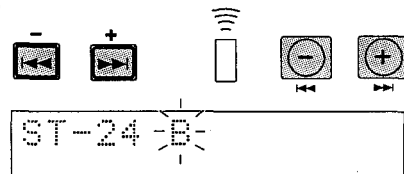

TO RECORD A STATION NAME (STATION NAME FUNCTION)

9. Press the SET button (cursor moves to the second character position).

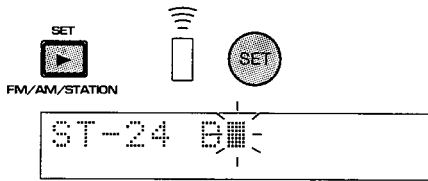

10. Use the ,  buttons to select character "B".

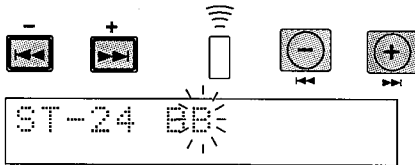

11. Press the SET button (cursor moves to the third character position).

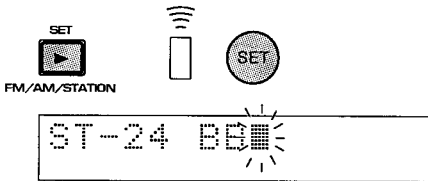

12. Use the ,  buttons to select character "C".

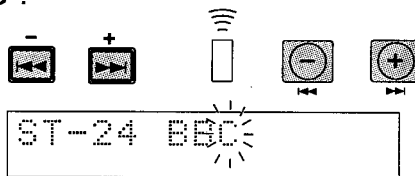

13. Press the MENU button.

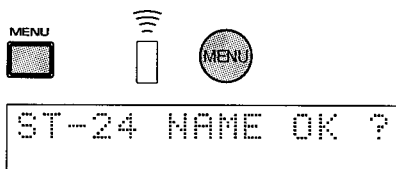

14. Press the SET button.

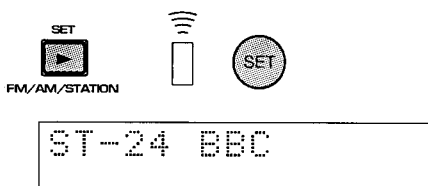

- To cancel the setting operation midway through, first press the MENU button, followed by the CANCEL button.

NOTES:

- If you do not wish to enter a character in a position, press the SET button to move the cursor to the next position.
- To return to a previous character position, press the CANCEL button to move backwards.
- To erase a character you have input, move the cursor to the character position, then enter a space  in the position.
- The space character is located at the end of each character list (in the alphabet lists, following the "/").
- To change the character type midway through the setting operation, press the CHARACTER button.
- To change a recorded name, use the CANCEL and SET buttons to move the cursor to the position you wish to change, then enter the new characters.

STATION CALL (Direct Tuning of Stations Stored in the Station Memory)

TO CHANGE DISPLAY MODES

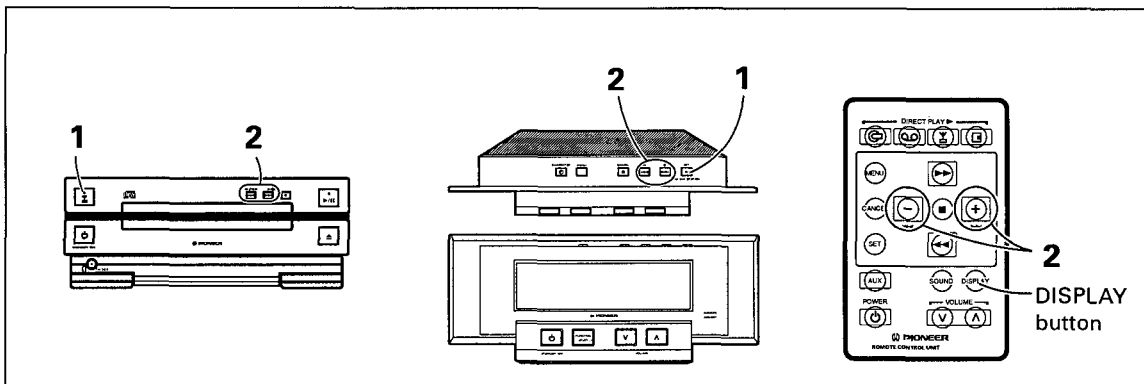

1. Press the FM/AM/STATION button to select the station display.



Each time the button is pressed, the mode changes in the sequence shown.

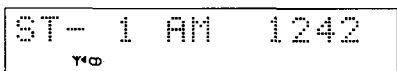
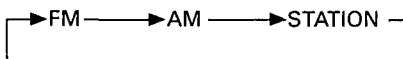

2. Use the \leftarrow and \rightarrow buttons to select the station you wish to receive.

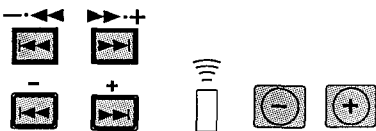

- When the " \rightarrow " button is pressed, station numbers change in ascending order, beginning with ST-1.
- When the " \leftarrow " button is pressed, station numbers change in descending order, beginning with ST-24.

NOTES:

- **What is Station Call?**
Station call means to receive (tune in) stations which have been preset in the station memory.
- **What is a station?**
A station refers to a radio broadcasting station that has been previously recorded in the station memory. When a station name has been entered in memory, the station name will be displayed following the station number.

When using the tuner function:

- Use the remote control unit's DISPLAY button to change the mode. Each time the button is pressed, the mode changes in the sequence shown:

During Broadcast Reception

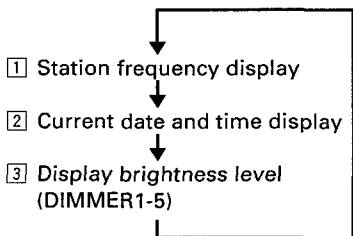

From Tuner to MD (display during recording)

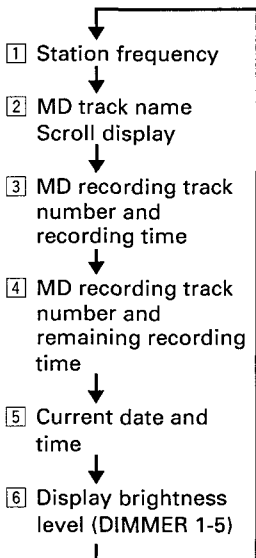

From Tuner to Tape (display during recording)

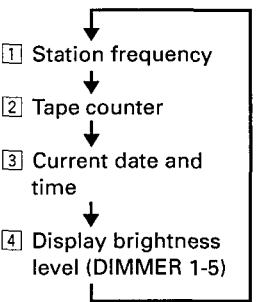

- To set the display brightness level (DIMMER 1-5), see P. 39.

RDS (Radio Data System) BROADCAST RECEPTION

What is RDS (Radio Data System)

In the RDS system, FM broadcast stations transmit such information as station name and programme type in addition to audio signals. This unit receives and displays the following three kinds of data.

RT (Radio Text) data

A message transmitted from the broadcast station using a maximum of 64 characters.

PS (Program Service Name) data

This refers to the broadcast station name transmitted by an FM broadcast station.

PTY (Program Type) data

During reception of an FM program, this data indicates the type of program.

The following are the 31 PTY data titles transmitted.

PTY NEWS	News	<ul style="list-style-type: none"> ● Short accounts of facts, events and publicly expressed views, reportage and actuality.
PTY AFFAIRS	Current affairs	<ul style="list-style-type: none"> ● Topical programme expanding or enlarging upon the news, generally in a different presentation style or concept, including debate, or analysis.
PTY INFO	Information	<ul style="list-style-type: none"> ● Programme whose purpose of which is to impart advice in the widest sense.
PTY SPORT	Sport	<ul style="list-style-type: none"> ● Programme concerned with any aspect of Sport.
PTY EDUCATE	Education	<ul style="list-style-type: none"> ● Programme intended primarily to educate, of which the formal element is fundamental.
PTY DRAMA	Drama	<ul style="list-style-type: none"> ● All radio plays and serials.
PTY CULTURE	Culture	<ul style="list-style-type: none"> ● Programmes concerned with any aspect of national or regional culture, including language, theatre, etc.
PTY SCIENCE	Science	<ul style="list-style-type: none"> ● Programmes about Natural Science and Technology.
PTY VARIED	Varied	<ul style="list-style-type: none"> ● Used for mainly speech-based programmes usually of light-entertainment nature, not covered by other categories. Examples include: quizzes, panel games and personality interviews.
PTY POP M	Pop	<ul style="list-style-type: none"> ● Commercial music, which would generally be considered to be of current popular appeal, often featuring current or recent record sales charts.
PTY ROCK M	Rock	<ul style="list-style-type: none"> ● Contemporary modern music, usually written and performed by young musicians.
PTY M. O. R. M	M.O.R.	<ul style="list-style-type: none"> ● (Middle of the Road Music). Common term to describe music considered to be "easy-listening", as opposed to Pop, Rock or Classical. Music in this category is often but not always, vocal, and usually of short duration.
PTY LIGHT M	Light classics	<ul style="list-style-type: none"> ● Classical Musical for general, rather than specialist appreciation. Examples of music in this category are instrumental music, and vocal or choral works.
PTY CLASSICS	Serious classics	<ul style="list-style-type: none"> ● Performances of major orchestral works, symphonies, chamber music etc., and including Grand Opera.
PTY OTHER M	Other music	<ul style="list-style-type: none"> ● Musical styles not fitting into any of the other categories. Particularly used for specialist music of which Rhythm & Blues and Reggae are examples.
PTY WEATHER	Weather	<ul style="list-style-type: none"> ● Weather reports and forecasts and Meteorological information.
PTY FINANCE	Finance	<ul style="list-style-type: none"> ● Stock market reports, commerce, trading, etc.

RDS (Radio Data system) BROADCAST RECEPTION

PTY CHILDREN	Children's programmes	<ul style="list-style-type: none">● For programmes targeted at a young audience, primarily for entertainment and interest, rather than where the objective is to educate.
PTY SOCIAL M	Social Affairs	<ul style="list-style-type: none">● Programmes about people and things that influence them individually or in groups. Includes: sociology, history, geography, psychology and society.
PTY RELIGION	Religion	<ul style="list-style-type: none">● Any aspect of beliefs and faiths, involving a God or Gods, the nature of existence and ethics.
PTY PHONE IN	Phone In	<ul style="list-style-type: none">● Involving members of the public expressing their views either by phone or at a public forum.
PTY TRAVEL	Travel	<ul style="list-style-type: none">● Features and programmes concerned with travel to near and far destinations, package tours and travel ideas and opportunities. Not for use for Announcements about problems, delays, or roadworks affecting immediate travel where TP/TA should be used.
PTY LEISURE	Leisure	<ul style="list-style-type: none">● Programmes concerned with recreational activities in which the listener might participate. Examples include, Gardening, Fishing, Antique collecting, Cooking, Food & Wine etc.
PTY JAZZ	Jazz Music	<ul style="list-style-type: none">● Polyphonic, syncopated music characterised by improvisation.
PTY COUNTRY	Country Music	<ul style="list-style-type: none">● Songs which originate from, or continue the musical tradition of the American Southern States. Characterised by a straightforward melody and narrative story line.
PTY NATION M	National Music	<ul style="list-style-type: none">● Current Popular Music of the Nation or Region in that country's language, as opposed to International 'Pop' which is usually US or U.K. inspired and in English.
PTY OLDIES	Oldies Music	<ul style="list-style-type: none">● Music from the so-called "golden age" of popular music.
PTY FOLK M	Folk Music	<ul style="list-style-type: none">● Music which has its roots in the musical culture of a particular nation, usually played on acoustic instruments. The narrative or story may be based on historical events or people.
PTY DOCUMENT	Documentary	<ul style="list-style-type: none">● Programme concerned with factual matters, presented in an investigative style.
PTY TEST	Alarm Test	<ul style="list-style-type: none">● Not to be used for searching - only used in a receiver for dynamic switching.
PTY ALARM!	Alarm	<ul style="list-style-type: none">● Emergency announcement made under exceptional circumstances to give warning of events causing danger of a general nature. Not to be used for searching - only used in a receiver for dynamic switching.

Note: These definitions can slightly differ between various language versions.

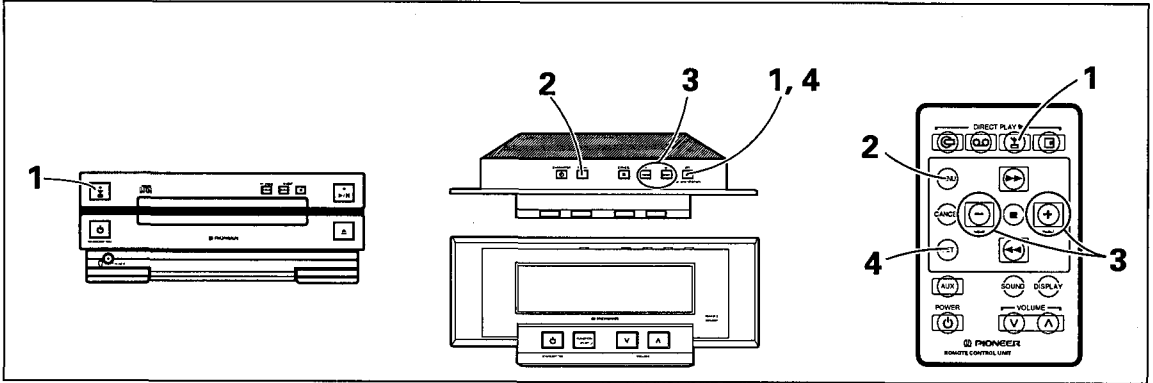

RDS SELECTION AND DISPLAY

1. Use the FM/AM/STATION button to select "FM."



2. Press the MENU button.



3. Use the +/- buttons to select one of the following: "RT," "PS," "PTY," or "PTY SEARCH."



RT mode	R T
PS mode	P S
PTY mode	PTY
PTY SEARCH mode	PTY SEARCH

When "RT," "PS," or "PTY" is selected, the SET button does not need to be pressed in step 4; about 3 seconds after the selection, the display will change automatically to display the selected data.

Each time the +/- buttons are pressed, the mode changes in the sequence shown.

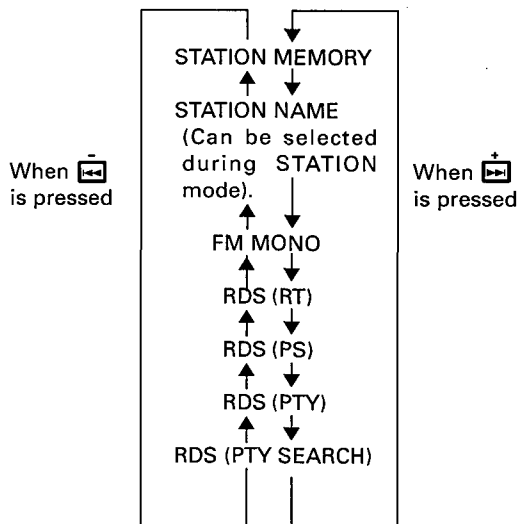

4. Press the SET button.

NOTES:

- The RDS indicator will light in the RDS mode.
- The mode is automatically indicated in the bottom of the display.
- If no RDS signal can be received, the "NO DATA" message will be displayed.
- If there is noise during the RT scroll display when in the RT mode, some characters may temporarily be incorrectly displayed.
- In the RT mode, when no RT data is transmitted, "NO RADIO TEXT DATA" is displayed.
- During RDS broadcast reception in the PTY mode, "NO TYPE" data may be displayed. In this case, it will automatically switch to PS mode after a few seconds.
- Depending on the broadcast station, numerous program station names (PS) may be transmitted in succession. In this case, when you switch to the RT mode, only some of the PS data will be displayed, so switch to the PS mode.

RDS (Radio Data system) BROADCAST RECEPTION

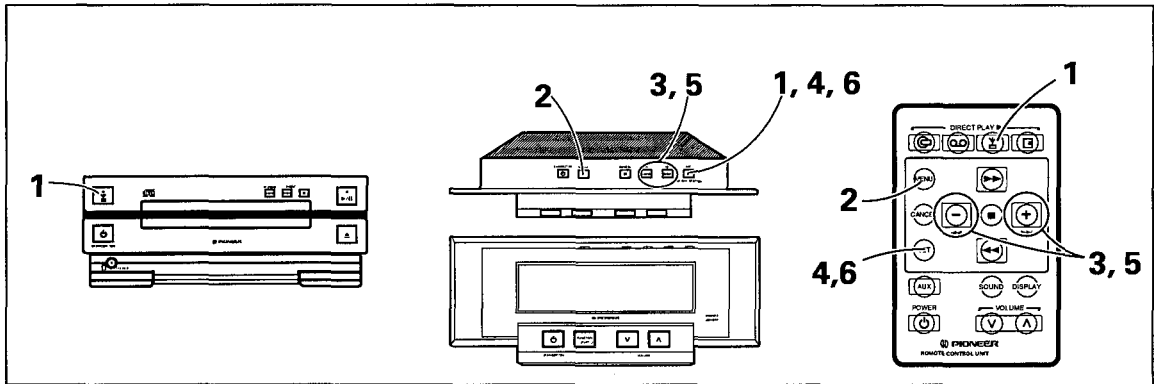

SEARCHING FOR A DESIRED PROGRAM BY PROGRAM TYPE (Program Type Search)

You can search for an FM broadcast of a desired program type (PTY).

1. Select FM with the FM/AM/STATION button.



2. Press the MENU button.



3. Use the and buttons to select "PTY SEARCH."

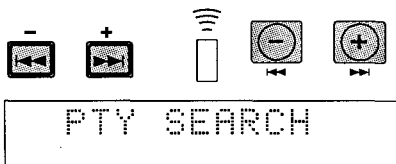

4. Press the SET button.

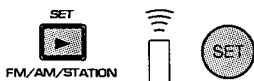

5. Use the and buttons to select the desired program type.



Example: When "NEWS" is selected.

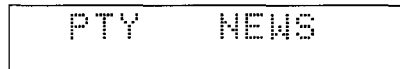

6. When your desired program type is displayed, press the SET button.



The search function begins from the station following the currently selected one, and broadcast stations conforming to the input program type are automatically received. If more than one station of the same program type is found, they are received one after the other for 6 seconds each, starting with any presets. When the station you want is received, press the SET button. Search stops, and reception of that station continues.

NOTES:

- When a broadcast of the selected program type cannot be found, search continues until the SET button is pressed.
- When an AM frequency is recorded among the memorized station positions, that frequency will be skipped and the search will continue.

CONVENIENT CD FUNCTIONS

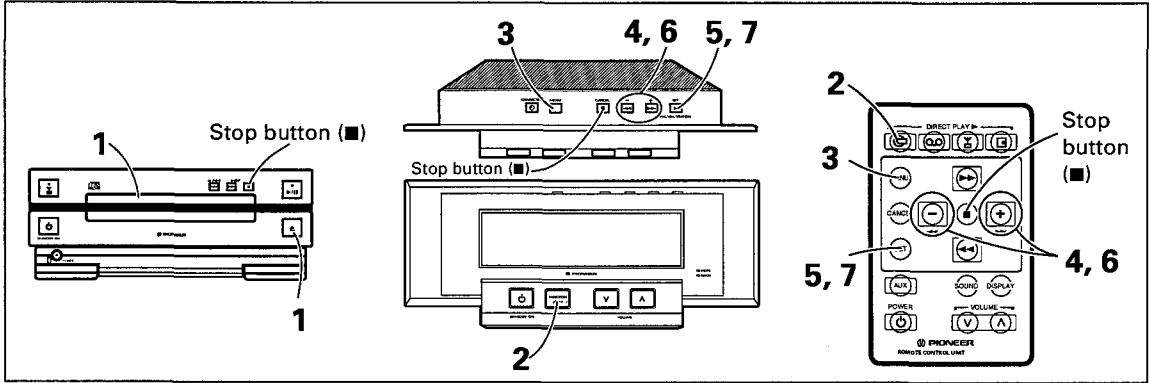

REPEAT PLAY

This function allows repeated play of a single track, or all the tracks on a disc.

1. Load a CD.

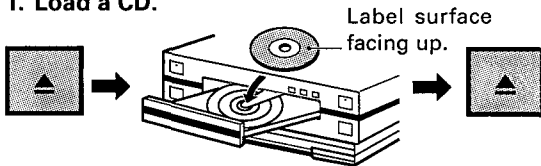

2. Use the **FUNCTION** button to select "CD."



3. Press the **MENU** button.

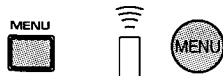

4. Use the \leftarrow , \rightarrow buttons to select "REPEAT MODE."

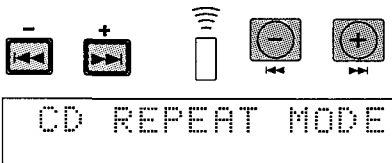

5. Press the **SET** button.

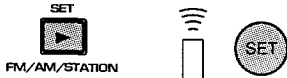

6. Use the \leftarrow , \rightarrow buttons to select either "1-track repeat" or "all-track repeat".



CD REPEAT TR.?

CD REPEAT ALL?

CD REPEAT OFF?

The repeat mode changes in the sequence shown.



7. Press the **SET** button.



1-track repeat

RPT1 4 3:21

All-track repeat

RPT 8 5:43

■ To cancel repeat play:

- Perform the operation above, but in step 6, select "OFF."
- Press the stop button (■) to interrupt play.

NOTE:

When a track has begun playing in the 1-track repeat mode, if manual search (\leftarrow , \rightarrow) or track search (\leftarrow , \rightarrow) is used to select a new track, the newly selected track will be played in 1-track repeat mode.

CONVENIENT CD FUNCTIONS

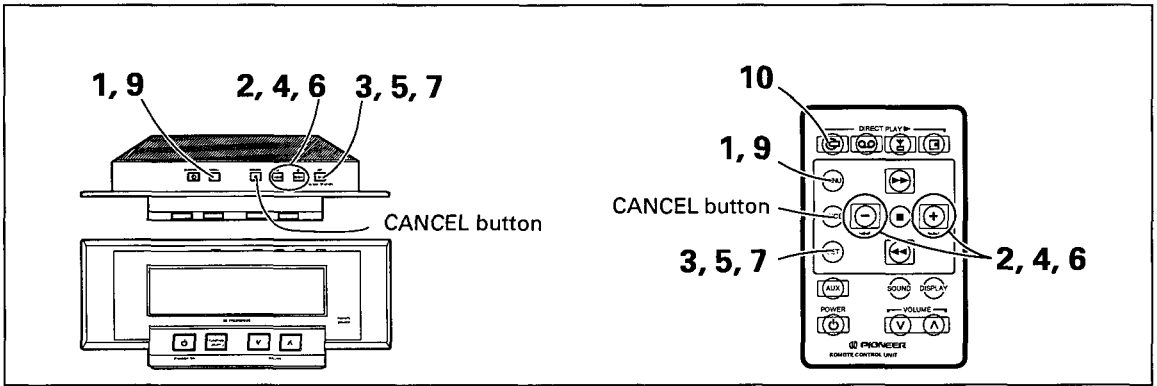

PROGRAMMED PLAY: To program playback of tracks in a desired order.

(This operation can be performed on the display unit or remote control unit)

- Up to 24 steps can be programmed.

Example: To program tracks 7 and 12 respectively.
When the function selector is set to CD:

1. Be sure that CD play is stopped, then press the MENU button.



2. Use the and buttons to select "PROGRAM."

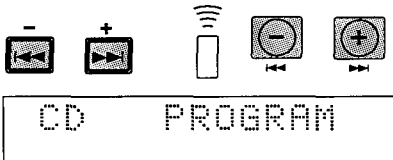

3. Press the SET button.

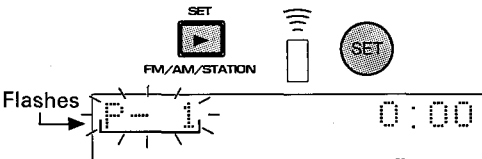

4. Use the and buttons to designate the first desired track (7th track).

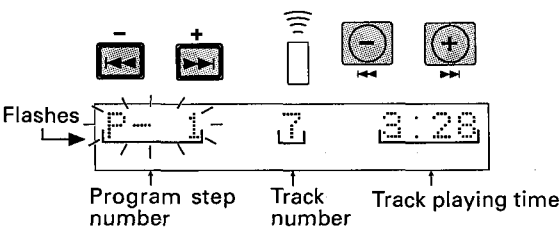

5. Press the SET button.

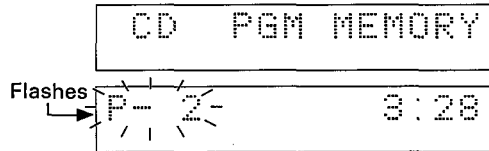

6. Use the and buttons to designate the next desired track (12th track).

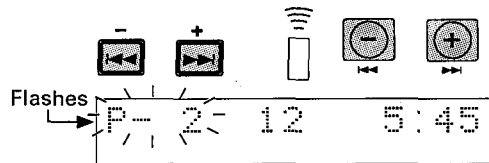

7. Press the SET button.

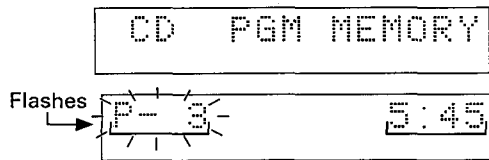

Program step number Total program playing time

8. To memorize additional tracks in the program, repeat steps 6-7.

- If an attempt is made to record more than 24 steps in a program, the display will show "PGM FULL."

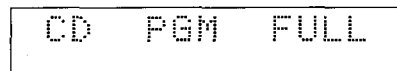

■ **If you enter the wrong track numbers:**
 Press the CANCEL button. Each time the button is pressed, one track will be cancelled from the program, beginning from the most recently programmed track and working backwards.

9. Press the MENU button.

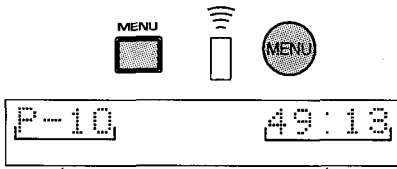

Example: Display when 10 tracks have been programmed.
 Example of total playing time when 10 tracks have been programmed.

10. Press the play/pause button to begin playing the selected tracks in programmed order.



■ **To cancel the program, perform one of the following:**

- During playback, press the stop button 2 times.
- During stop mode, press the stop button 1 time (during the stop mode, the total playing time is displayed).

■ **To confirm program contents**

- During stop mode, press the buttons to display the programmed contents, one step at a time.

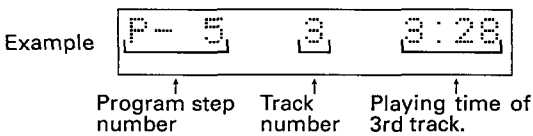

- Press the stop button to return to the display of the total playing time.

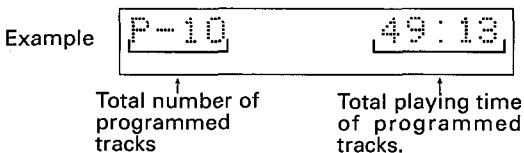

NOTES:

- A pause cannot be programmed.
- The memorized programmed contents will be cancelled if the disc is removed or if the power is turned off.

- If repeat play is selected during programmed play, the following display will appear.

1-track repeat



All-track repeat

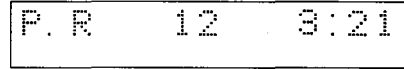

CONVENIENT CD FUNCTIONS

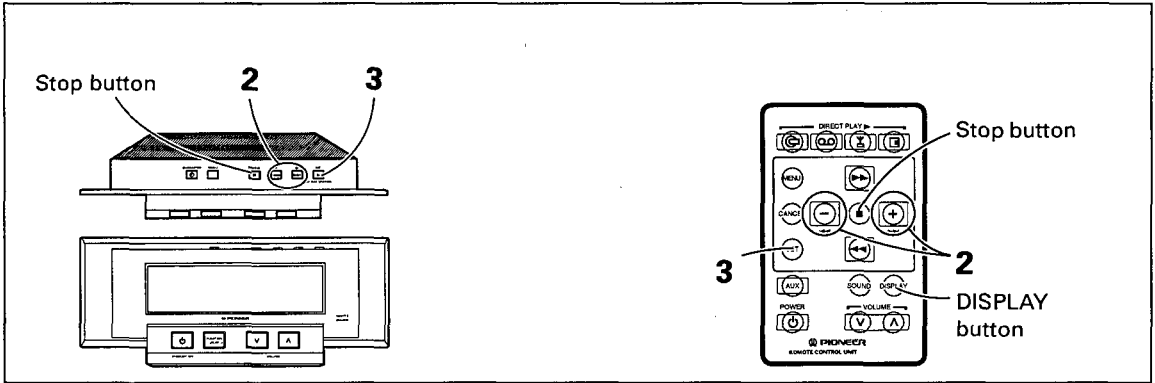

RANDOM PLAY

(This operation can be performed on the display unit or remote control unit)

This function plays all tracks of a disc in random order.

1. Perform steps 1-3 for repeat play (see P. 31).
2. Use the , buttons to select "RANDOM PLAY."

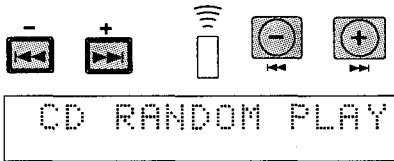

3. Press the SET button.

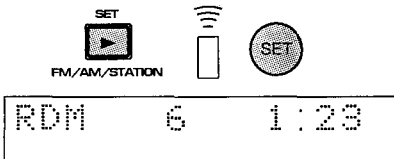

■ To cancel random play

Press the stop button () to interrupt play.

NOTES:

- During random play, pressing the (button) will cause the currently playing track to stop playing, and playback will change to another randomly selected track.
- During random play, selecting all-track repeat (see P. 31) will cause random playback to be repeated (random repeat).

Display example:

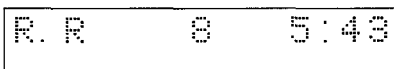

TO CHANGE DISPLAY MODES

When the CD function has been selected:

- Use the remote control unit's DISPLAY button. Each time the button is pressed the function changes in the following sequence:

When CD is stopped

To change the brightness level of the display (DIMMER 1-5), see P. 39.

- 1 Total tracks, total playing time
- 2 Current date and time
- 3 Display brightness level (DIMMER 1 - DIMMER 5)

Display during CD playback

- 1 Elapsed playing time
- 2 Remaining playing time of current track
- 3 Total remaining playing time
- 4 Total tracks and total playing time
- 5 Current date and time
- 6 Display brightness (DIMMER 1-5)

Display when recording from CD to MD:

- Name of MD track (scrolling display)
- MD recording track number and recording time
- MD recording track number and remaining recording time

Display when recording from CD to tape:

- Tape counter

- During CD to MD or CD to tape two recording, the respective data shown are added between display steps 4 and 5 of the CD playback data display.

During random play, display 3 is not shown.

CONVENIENT TAPE FUNCTIONS

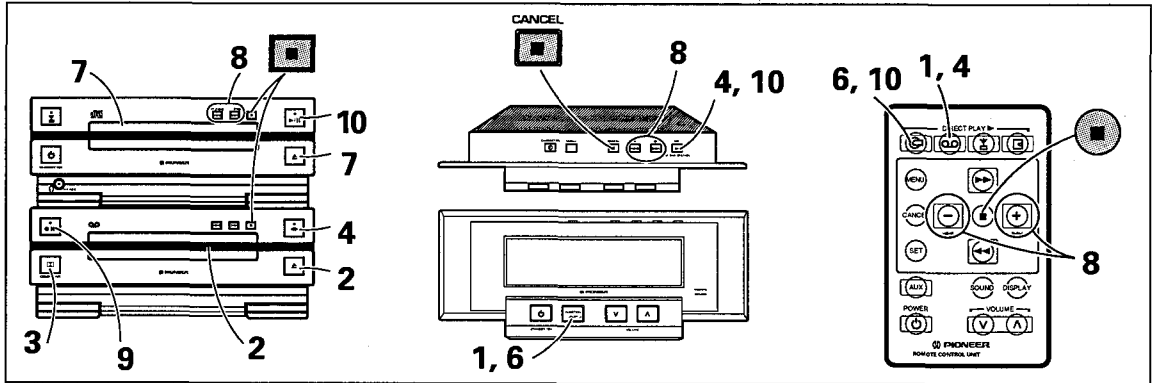

SYNCHRO RECORDING (CD→TAPE)

1. Use the display unit or remote control unit to select the TAPE function.



2. Insert the cassette tape onto which you wish to record.

(For more details, see P. 18, 22).

3. Press the DOLBY B NR button to set the Dolby noise reduction function ON or OFF as desired.

Each time the button is pressed, the function turns alternately ON and OFF as shown.

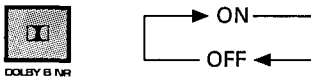

4. Press the play/direction button corresponding to the tape direction in which you wish to record.

The display unit's indicator will show the direction.



The tape travel direction changes alternately each time the button is pressed.

Press the stop button (■) after selecting the recording direction.

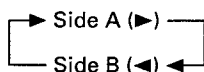

5. Select the desired reverse mode.

(For more details, see P. 18.)



Recording stops after one side.

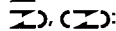

If recording is started from side A (▶ direction), recording continues to side B (◀ direction). If recording is started from side B (◀ direction), recording stops after completion of recording on side B only.

6. Use the display unit or remote control unit to select the CD function.



7. Load the CD from which you wish to record. Label side facing up.

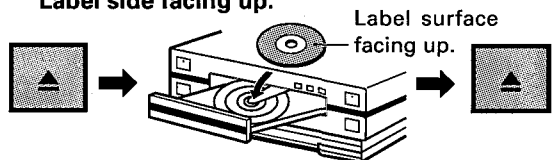

8. Use the [◀], [▶] buttons to select the track you wish to record (1-track synchro recording).

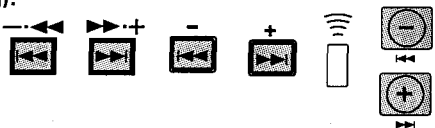

- When a track is designated in this way, 1-track synchro recording will be automatically selected.
- To record all tracks on the disc, omit the above step (do not designate any specific track) and with the CD stopped, confirm that the display is showing the total track display. If the total track display is not showing, press the CD stop button (■).

CONVENIENT TAPE FUNCTIONS

9. Press the recording pause button.



The unit enters the recording pause mode.

10. Press the CD play/pause button or SET button on the display unit.

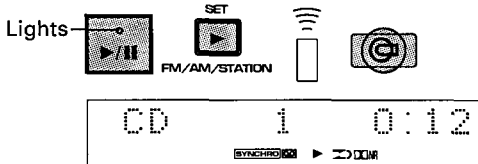

- The disc will begin playback, and the cassette tape deck will begin recording simultaneously.
- When the selected disc or track completes playback, the cassette tape will also stop.

■ To manually stop recording

Press the stop button (■) on the CD receiver or cassette deck.



NOTES:

- When the tape cassette comes to the end of side A and recording switches to side B, if CD playback is in the middle of a track, that entire track will be recorded anew on side B.
- If the CD has been programmed for playback in a specific track order, or for repeat playback, synchro recording will be performed of the respective mode.
- To perform synchro recording of a single track (1-track synchro), use step 8 to designate the desired track before beginning recording in step 9.

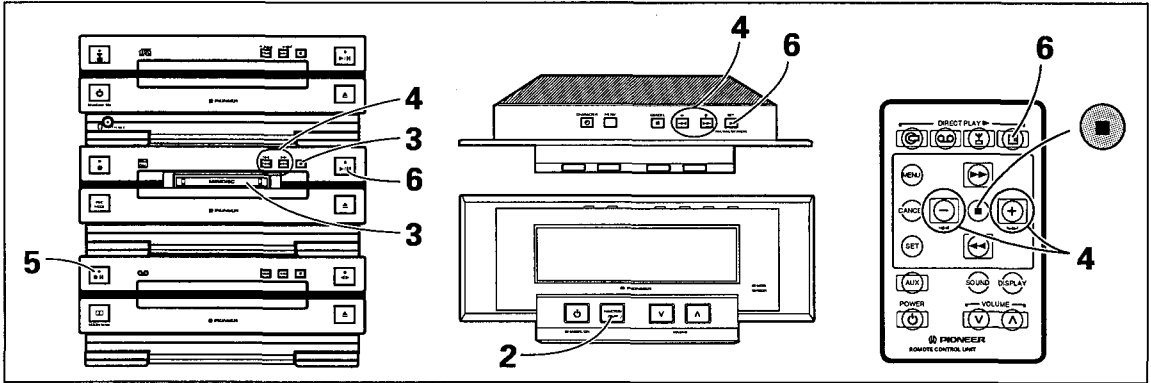

SYNCHRO RECORDING (MD → TAPE)

(Applicable only when the optional MiniDisc Recorder MJ-L7 is purchased)

1. Perform steps 1-5 for CD → tape synchro recording (P. 35).
2. Use the display unit or remote control unit to select the MD function.



3. Load the MiniDisc whose contents you wish to record.

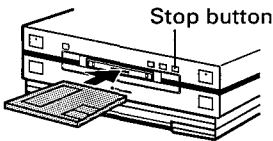

- If a playback-only disc is loaded, playback will automatically begin from track 1. Press the stop button to stop playback.

4. Use the and buttons to select the track you wish to record (for 1-track synchro recording).

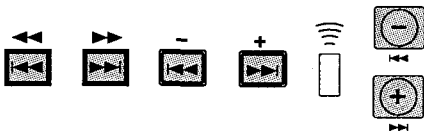

- When a specific track is selected in the above way, 1-track synchro recording will automatically be selected.
- To record all tracks on the MiniDisc, omit the above step (do not designate any specific track) and with the MD recorder in stop mode, confirm that the display shows the total tracks.
- If the display does not show the total tracks, press the MD recorder's stop button (■).

5. Press the recording pause button.



The unit enters the recording pause mode.

6. Press the MD play/pause button or SET button on the display unit.



- The MiniDisc will begin playback and the cassette deck will simultaneously begin recording.
- When the MiniDisc completes playback, the cassette tape will also stop.

To manually stop recording

Press the stop button (■) on the MD recorder or cassette deck.



NOTES:

- When the tape cassette comes to the end of side A and recording switches to side B, if MD playback is in the middle of a track, that entire track will be recorded anew on side B.
- If the MD has been programmed for playback in a specific track order, or for repeat playback, synchro recording will be performed of the respective mode.
- To perform synchro recording of a single track (1-track synchro), use step 8 to designate the desired track before beginning recording in step 9.

CONVENIENT TAPE FUNCTIONS

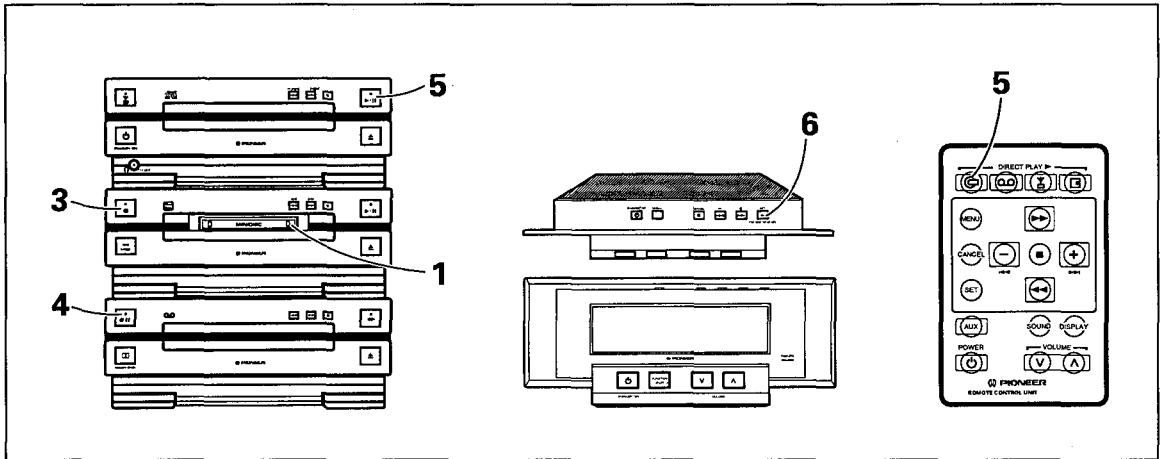

PARALLEL SYNCHRO RECORDING (CD → MD & TAPE)

(Applicable only when the optional MiniDisc Recorder MJ-L7 is purchased)

1. Load the MiniDisc onto which you wish to record.

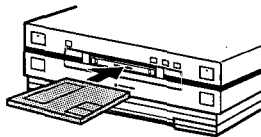

2. Perform steps 1-8 for CD → tape synchro recording (P. 35).

3. Press the MD recorder's recording button.
The MD recorder enters the recording-pause mode.



Lights



Flashes

(Recording button) (Play/pause button)

● If the CD receiver and MD recorder are not connected with the digital optical fiber cable, the MD recorder will be unable to enter the recording pause mode, thus making it impossible to perform parallel synchro recording.

4. Press the cassette tape deck's recording-pause button.

Lights



Flashes



The cassette tape deck enters the recording-pause mode.



Flashes

5. Press the CD receiver's play/pause button (or SET button on the display unit).

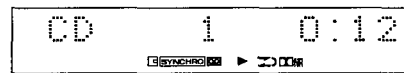

- The CD will begin playback, and recording will begin simultaneously on the MiniDisc and cassette tape.
- When the CD completes playback, recording will also stop on the MiniDisc and cassette tape.

■ To manually stop recording:

Press the stop button (■) on the CD receiver, cassette deck, or MD recorder.



NOTES:

- When the tape cassette comes to the end of side A and recording switches to side B, if CD playback is in the middle of a track, that entire track will be recorded anew on side B.
- If the CD has been programmed for playback in a specific track order, or for repeat playback, synchro recording will be performed of the respective mode.
- To perform synchro recording of a single track (1-track synchro), use step 8 (P. 35) to designate the desired track before proceeding to the next step to begin recording.

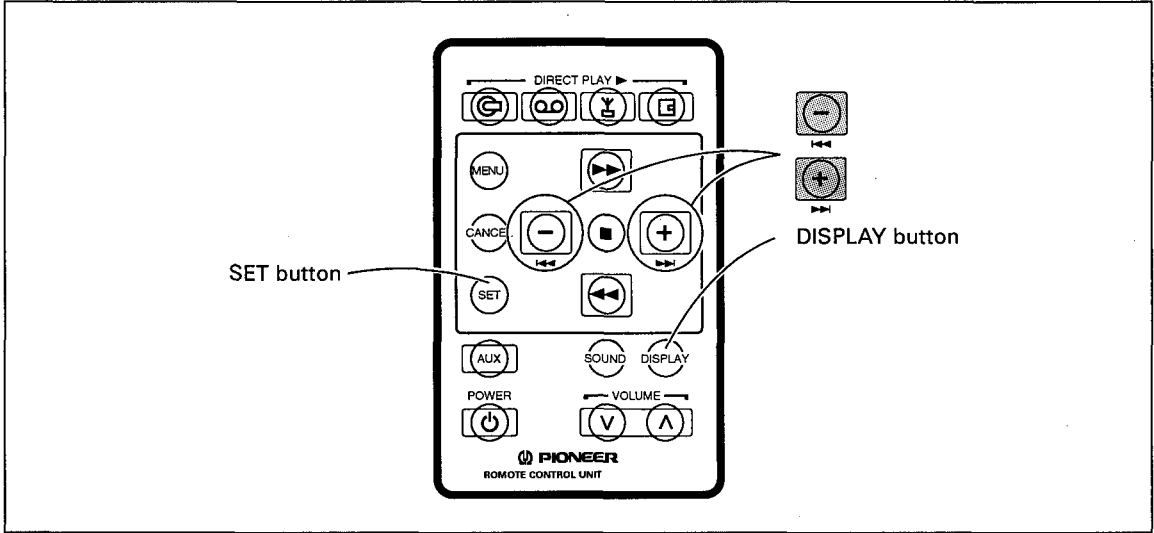

TO CHANGE DISPLAY MODES

- Perform this operation by pressing the remote control unit's DISPLAY button.

Press the DISPLAY button.

- Each time the button is pressed, the mode changes in the sequence shown:

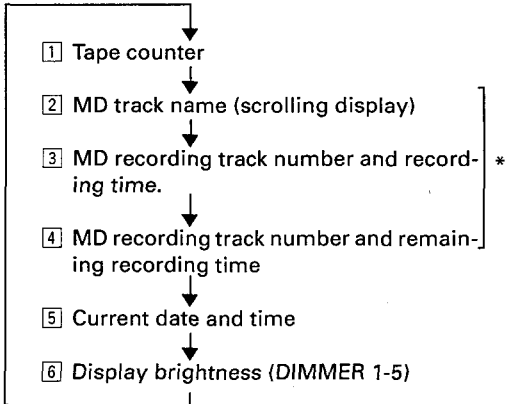

* Can be selected only when recording from tape to MD.

■ To change the display brightness (DIMMER)

1. Press the DISPLAY button to select "DIMMER" (brightness level).



2. Press the SET button.



3. Use the - and + buttons to select one of the dimmer settings (1 to 5).



4. Press the SET button.



USING THE TIMER

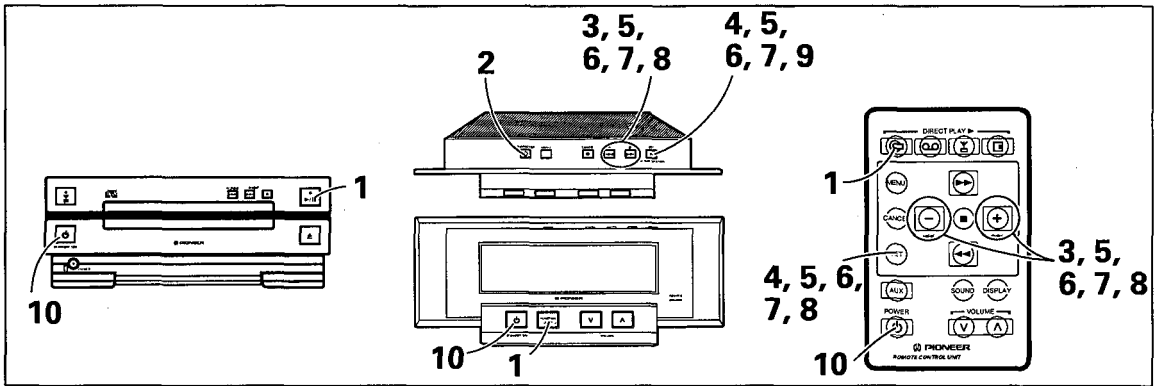

Timer functions cannot be used if the current time has not been properly set on the clock. (see P. 15)

WAKE-UP TIMER

First of all . . .

Prepare the source you wish to play.

- CD: Load the desired disc.
- Tuner: Tune the receiver to the desired broadcast station. The station received when the timer is set will be turned on by the timer.
- Tape: Load the desired playback cassette tape.
- MD: Load the desired disc.

Adjust the volume as desired

This will be the volume used when the timer turns the component on.

Example: Using the timer to play back a CD from 6:30 to 8:00 A.M.

1. Select the CD function.



2. Press the CHARACTER/timer button on the display unit.



3. Use the \leftarrow , \rightarrow buttons to select "WAKE-UP."

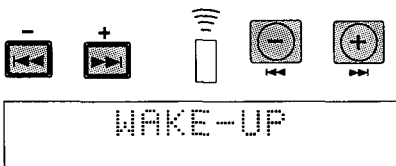

4. Press the SET button.



5. Set the timer start time (hour).

Use the \leftarrow , \rightarrow buttons to set the desired hour, then press the SET button.

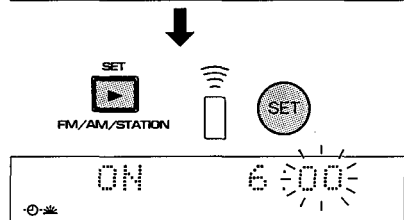
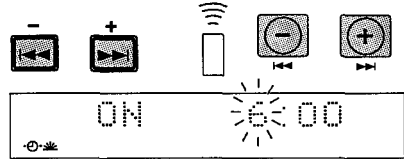

6. Set the timer start time (minutes).

Use the \leftarrow , \rightarrow buttons to set the desired minutes, then press the SET button.

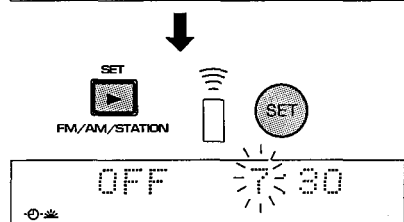
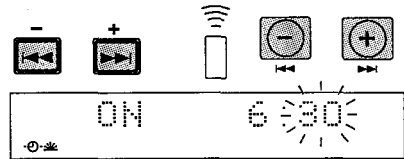

The display will automatically change to show the time one hour after the set starting time.

7. Set the timer off time (hour).

Use the , buttons to set the desired hour, then press the SET button.

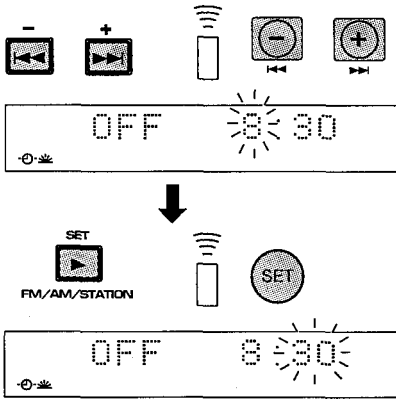

■ **To change the timer settings:**

Repeat the setting procedure from the first step. If one of the setting contents is the same, however, merely press the SET button and go on to the next setting.

■ **To turn off the timer function:**

- ① Press the CHARACTER/timer button.
- ② Use the , buttons to select the "WAKE-UP" mode.
- ③ Press the SET button.
The display unit's timer indicator () will turn off.

NOTE:

Once set, the wake-up timer will operate at the same time each day until reset or turned off.

8. Set the timer off time (minutes).

Use the , buttons to set the desired minutes.

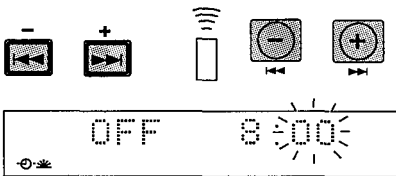

9. Press the SET button and the selected time will be automatically confirmed.

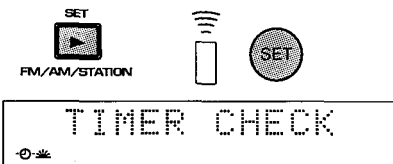

After a few seconds, the timer check is completed.

10. Turn off the unit power.

The system will enter the standby mode.



The display will show the current date and time.

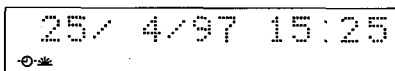

■ **To cancel the setting procedure midway through:**

Press the CHARACTER/timer button.



USING THE TIMER

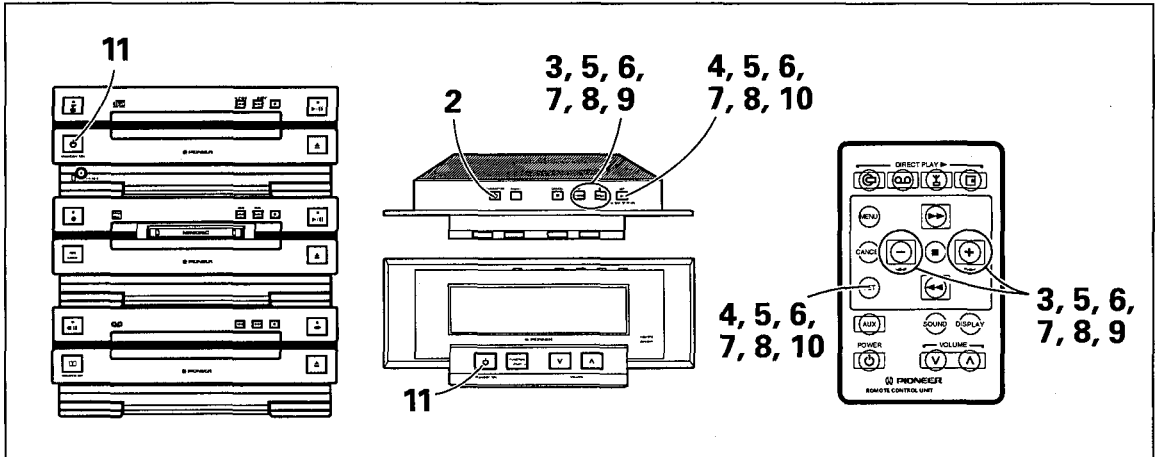

UNACCOMPANIED RECORDING (TIMER RECORDING)

First of all . . .

- Unaccompanied (timer) recording can be performed only from the tuner, or a source component connected to the AUX jacks. When selecting AUX, be sure to set the connected component to start playing at the time the timer turns it on.
- When selecting tuner, set the tuner to the station you wish to record. The station selected during the timer setting process will be the one turned on by the timer.
- **When recording to MD:**
Load a recordable MD in the MD recorder, and set the unit to the proper condition for recording.
- **When recording to cassette tape:**
 - ① Use the play button to select the initial recording direction (◀ or ▶).
 - ② Insert a tape for recording.
 - ③ Set Dolby NR and reverse mode as desired.

Example: To record a radio broadcast on cassette tape from 9:30 A.M. to 11:00 A.M.

1. Tune in the radio station you wish to record.
(For details regarding tuning, see P. 16, 26)
2. Press the CHARACTER/timer button.



3. Use the ◀, ▶ buttons to select "TIMER REC".



4. Press the SET button.

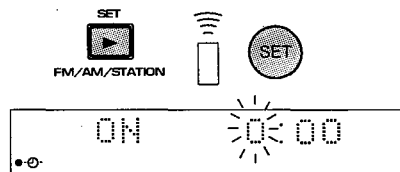

5. Set the timer start time (hour).

Use the ◀, ▶ buttons to set the hour, then press the SET button.

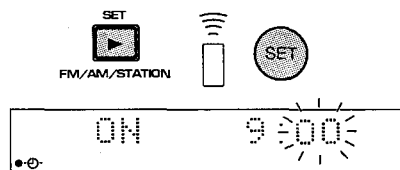
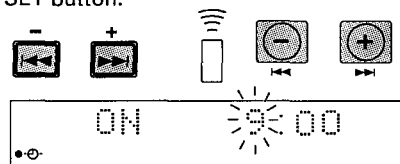

6. Set the timer start time (minutes).

Use the , buttons to set the minutes, then press the SET button.

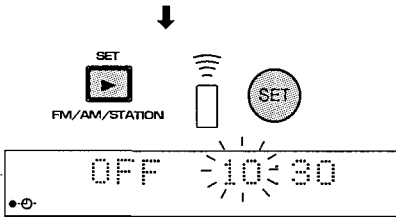
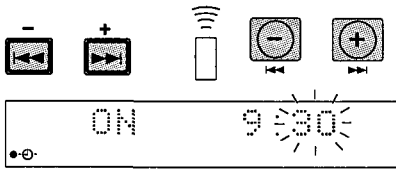

The display will automatically change to show the time one hour after the set starting time.

7. Set the timer off time (hour).

Use the , buttons to set the timer off time (hour), then press the SET button.

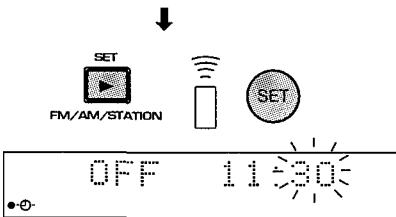
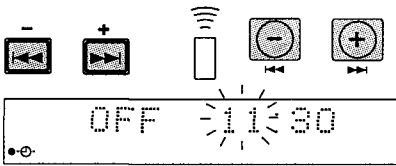

8. Set the timer off time (minutes).

Use the , buttons to set the timer off time (minutes), then press the SET button.

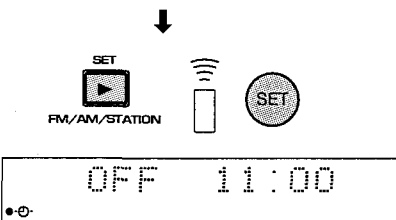
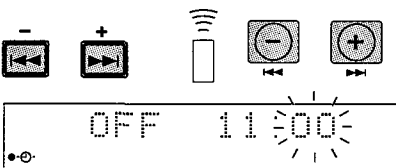

9. Use the , buttons to select the recording component "TAPE REC".

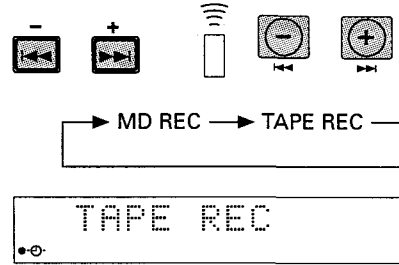

10. Press the SET button and the selected time will be automatically confirmed.

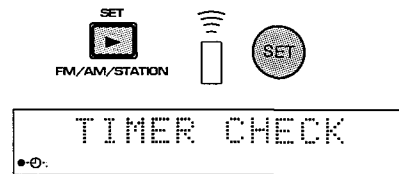

After a few seconds, the timer check is completed.

11. Turn off the unit power.

The system will enter the standby mode.

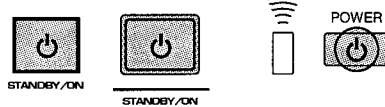

The display will show the current date and time.

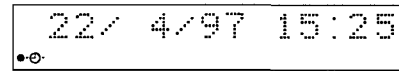

■ **To cancel the setting procedure midway through:**

Press the CHARACTER/timer button.





■ **To change the timer settings:**

Repeat the setting procedure from the first step. If one of the setting contents is the same, however, merely press the SET button and go on to the next setting.

USING THE TIMER

■ To turn off the timer function:

- ① Press the CHARACTER/timer button.
 - ② Use the ,  buttons to select the "TIMER REC" mode.
 - ③ Press the SET button.
The display unit's timer indicator (●-⊖) will turn off.
- During timer recording, the volume level is automatically set to "0," and no sound is produced from the speakers.
 - During timer recording, the selected timer settings operate once only, after which the timer operation is automatically turned off.

NOTE:

Following timer recording, the sound volume automatically remains set at "0".

Examples of Timer Use:

- Combined application (wake-up timer + timer recording)

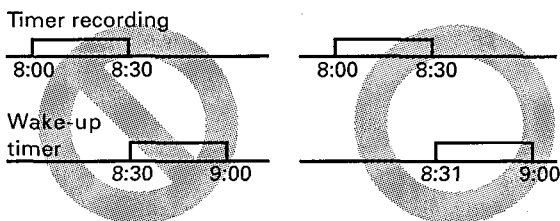

NOTES:

- When using the wake-up timer and timer recording functions contiguously, at least one minute must be left between the end of one function and the beginning of the other function.
- If no interval is left between the set times, the function scheduled afterwards will not operate according to its set time.

- Combined application (sleep timer + wake-up timer)

Example: Go to sleep listening to a CD, and wake up to an FM broadcast.

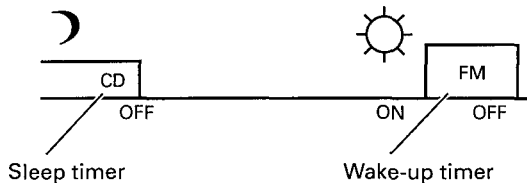

NOTES:

- When multiple timer settings overlap, the function set to operate earliest will be given priority.
- If overlapping start times are set, timer recording will be given priority in wake-up timer operations.

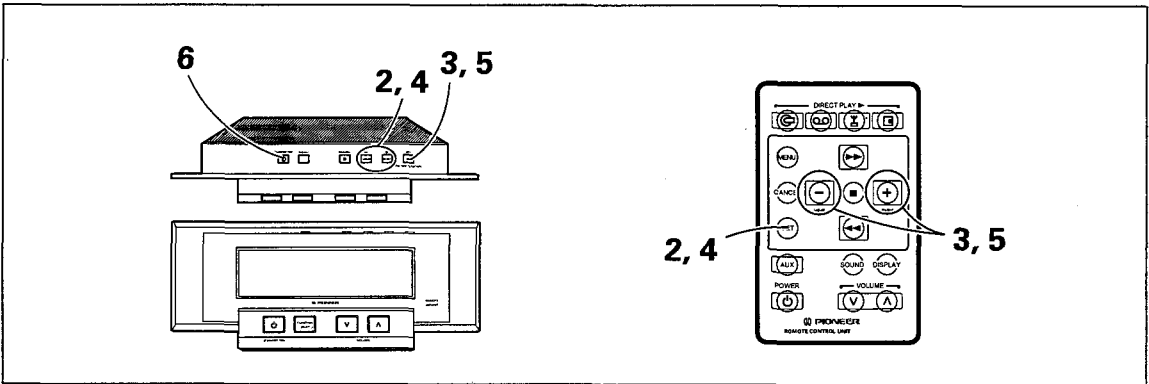

SLEEP TIMER

- Power turns off automatically after the specified time has elapsed.
- Perform this operation with the display unit or remote control unit.

1. Press the **CHARACTER/timer** button.



2. Use the **←**, **→** buttons to select "SLEEP TIMER".

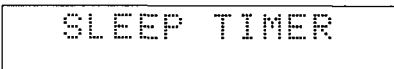

3. Press the **SET** button.



4. Use the **←**, **→** buttons to select the length of time (minutes) you wish the timer to operate.

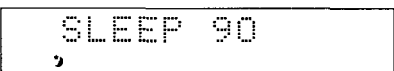

Example: To automatically turn off the power after 90 minutes.

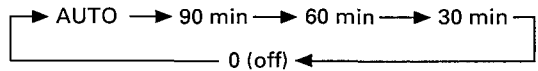

AUTO (Auto Sleep)

Can be selected during playback of CD, MD, or cassette tape, or during recording of MD or cassette tape. If playback or recording ends, the timer will automatically turn off one minute later. During operation of the sleep timer, the display will be dimmed (dimmer function).

5. Press the **SET** button.



■ **To confirm how many minutes remain on the sleep timer:**

- ① Press the **CHARACTER/timer** button.
- ② Use the **←**, **→** buttons to select "SLEEP TIMER".
- ③ Press the **SET** button. The display will show the remaining time.
- ④ Press the **SET** button; the display will return to its previous setting.

ADJUSTING TONE AND BALANCE

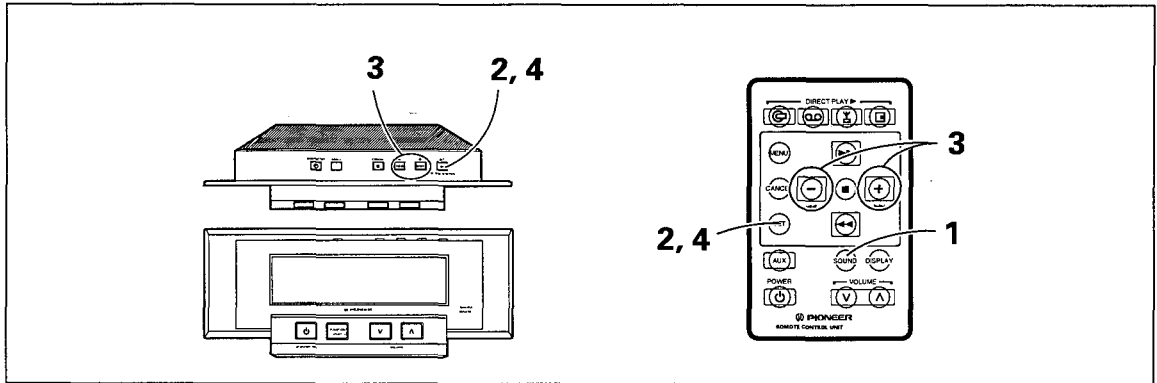

ADJUSTING THE HIGH/LOW FREQUENCY RANGES (TONE CONTROL)

1. Press the remote control unit's **SOUND** button to select the range you wish to adjust ("BASS" or "TREBLE").
Each time the button is pressed, the available adjustments will change in the sequence shown.

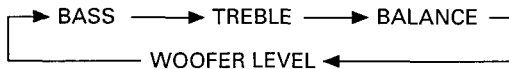

To adjust the high tone Select TREBLE
To adjust the low tone Select BASS

2. Press the **SET** button.



3. Use the **←**, **→** buttons to adjust the tone as desired.
(Tone can be adjusted within a range of -4 to +4 steps).

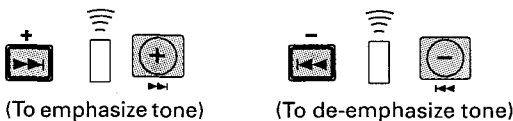

- Even if the SET button is not deliberately pressed to confirm the setting, the setting will be automatically confirmed about five seconds after completing the tone level adjustment.

4. Press the **SET** button.

- **To cancel the adjustment procedure mid-way through:**

Press the **MENU** button.

TO ADJUST THE RIGHT-LEFT BALANCE

1. Use the remote control unit's **SOUND** button to select "BALANCE."
2. Press the **SET** button.



3. While listening to the sound from the speakers, use the **←**, **→** buttons to adjust the right-left balance.

Adjust the balance so that center sounds (vocals, monaural sources, etc.) appear to come from exactly between the right and left speakers.

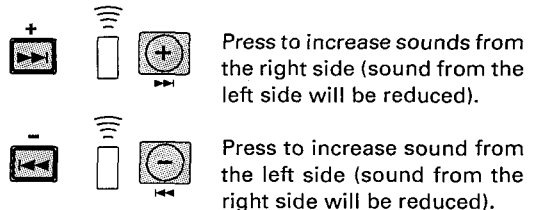

- Adjustments can be performed within the range of Left 10 ↔ Center ↔ Right 10 in steps.
- Even if the SET button is not deliberately pressed to confirm the setting, the setting will be automatically confirmed about five seconds after completing the balance level adjustment.

4. Press the **SET** button.

- **To cancel the adjustment procedure mid-way through:**

Press the **MENU** button.

Tone, woofer level and balance adjustments have no effect on sound produced during recording.



ADJUSTING TONE AND BALANCE

TO ADJUST THE WOOFER LEVEL

1. Use the remote control unit's **SOUND** button to select "WOOFER LEVEL."

2. Press the **SET** button.



3. Use the  and  buttons to adjust the woofer level as desired. The woofer volume level can be set in three steps: "high," "medium," and "low."

4. Press the **SET** button.

- Even if the SET button is not deliberately pressed to confirm the setting, the setting will be automatically confirmed about five seconds after completing the woofer level adjustment.

■ **To cancel the adjustment procedure midway through:**

Press the **MENU** button.

MAINTENANCE

CLEANING THE HEAD SECTION (Optional Cassette Deck CT-L7)

To enjoy a perfect performance and high-quality sound, clean the head periodically (once every 10 hours). A head cleaning cassette is necessary for cleaning the recording/playback heads. Please use a commercially available "Wet-type" cleaning cassette. (For details, refer to the instructions supplied with the cleaning cassette.)

Caution:

- Some head cleaning tapes are not designed for use on autoreverse decks. Be careful since there is a danger that you will not be able to remove the cleaning cassette. Ask your PIONEER authorized service center or dealer for details.
- Do not use a head cleaning tape which does not conform to the specified standards.
- Do not use a dry-type cleaning cassette tape.
- After cleaning the head, do not load a cassette tape until the cleaning liquid has dried (about 2 or 3 minutes).

DEMAGNETIZING THE HEAD (Optional Cassette Deck CT-L7)

The recording/playback head becomes magnetized when you use the tape deck for prolonged periods of time. This results in noise being generated and the treble dropping off during recording and playback. The recording/playback head should therefore be demagnetized regularly with a commonly sold head demagnetizer. When demagnetizing the head, switch the CD receiver's power ON. To avoid adversely affecting the receiver and speakers, be sure to set the volume level to minimum. Also disconnect the headphone plug from the PHONES jack.

For further details, refer to the operating instructions accompanying your head demagnetizer.

MAINTENANCE OF EXTERNAL SURFACES

- Use a polishing cloth or dry cloth to wipe off dust and dirt.
- When the surfaces are very dirty, dip a soft cloth in some neutral cleanser (diluted five or six times with water), wring the cloth well, and wipe the surfaces clean. Then, wipe again with a dry cloth. Do not use furniture wax or cleaners.
- Never use thinners, benzine, insecticide sprays or other chemicals on or near this unit, since these will corrode the surfaces.

CD LENS CLEANER

The player's pickup lens should not become dirty in normal use, but if for some reason it should malfunction due to soiling, consult your nearest PIONEER authorized service center. Lens cleaners for CD players are commercially available, but special care should be exercised in their use since some may cause damage to the lens.

TROUBLESHOOTING

Incorrect operations are often mistaken for trouble and malfunctions. If you think that there is something wrong with this component, check the points below. Sometimes the trouble may lie in another component. Investigate the other components and electrical appliances being used. If the trouble cannot be rectified even after exercising the checks listed below, ask your nearest PIONEER authorized service station to carry out repair work.

	Symptom	Likely Cause	Remedy
Common to all components	Power does not turn on.	<ul style="list-style-type: none"> ● Display unit's cord is disconnected. 	<ul style="list-style-type: none"> ● Connect display unit cord properly (☞ P. 7).
	Power turns off abruptly during operation.	<ul style="list-style-type: none"> ● Cooling fan vent is blocked. ● The CD receiver has been set on top of a soft cloth or long-pile rug, thus blocking the cooling vents. 	<ul style="list-style-type: none"> ● Install so that the fan is not blocked. ● Do not install the CD receiver on top of materials that may block the vents.
	No sound	<ul style="list-style-type: none"> ● Power plug is disconnected. ● Not all connection cables are connected properly. ● Input selector is not set correctly. ● Unit is set to DEMO mode. 	<ul style="list-style-type: none"> ● Connect the power plug correctly ● Refer to the section on connections and make sure all connections are correct and secure. ● Press the Display unit's FUNCTION button and select the desired component. ● To cancel the demo mode, press the power switch on either of the CD receiver, display unit, or remote control unit while the demo mode is operating.
	Can't switch between functions.	<ul style="list-style-type: none"> ● Cassette deck or MD recorder is currently recording. 	<ul style="list-style-type: none"> ● Function selector cannot be operated during recording.
CD player	Play doesn't start when the play/pause button is pressed.	<ul style="list-style-type: none"> ● Disc has been inserted upside down. ● Disc is dirty. ● Disc has scratches. 	<ul style="list-style-type: none"> ● Load discs with label side (printed surface) upwards. ● Clean the disc. ● Replace the disc.
Tuner	Can't listen to broadcasts, or sound is distorted.	<ul style="list-style-type: none"> ● Antenna isn't connected. ● Antenna direction or position is poor. ● An electrical appliance (fluorescent lamp, hair dryer, etc.) is being used in the near vicinity. ● The frequency interval is incorrectly set. 	<ul style="list-style-type: none"> ● Connect the antenna properly. ● Orient antenna to the proper direction and position. ● Discontinue use of the appliance producing the noise, or move it farther away from the antenna. ● Adjust the tuning frequency interval correctly (☞ P. 49).
	Broadcast is in stereo, but sound from speakers is monaural.	<ul style="list-style-type: none"> ● Monaural indicator is lit in the display. 	<ul style="list-style-type: none"> ● Use the MENU button to select "FM AUTO" (☞ P. 16).
Tape Deck	Cassette tray doesn't open.	<ul style="list-style-type: none"> ● Electric power cord has been disconnected during tape travel. 	<ul style="list-style-type: none"> ● Reconnect the power cord.
	Can't record	<ul style="list-style-type: none"> ● Erasure-prevention tabs are broken out from the tape cassette. 	<ul style="list-style-type: none"> ● Either replace the tape, or place cellophane tape over the erasure-prevention tabs (☞ P. 21).
	Sound is muddy or distorted. When recording over a previously recorded tape, the previous recording can still be heard.	<ul style="list-style-type: none"> ● Heads are dirty. 	<ul style="list-style-type: none"> ● Clean the heads (☞ P. 47).
	Playback sound is muddy or distorted; high frequency sounds are excessively emphasized.	<ul style="list-style-type: none"> ● The Dolby NR setting is not the same as that used during recording. 	<ul style="list-style-type: none"> ● Set the Dolby NR system to the same setting as that used during recording (☞ P. 18).

	Symptom	Likely Cause	Remedy
Others	Timer doesn't operate.	<ul style="list-style-type: none"> ● Clock isn't set to the correct current time. ● Power interruption has caused the clock to be set to the incorrect time (when display is flashing). 	<ul style="list-style-type: none"> ● Reset the clock to the correct current time. (☞ P. 15) ● Reset the clock to the correct current time. (☞ P. 15)
	Remote control unit doesn't work.	<ul style="list-style-type: none"> ● Batteries are exhausted. ● A fluorescent lamp is located close to the remote control unit. ● The remote control unit is not pointed at the signal receiver on the display unit. 	<ul style="list-style-type: none"> ● Load new batteries. ● Remove the fluorescent lamp from the area of the remote control unit. ● Point the remote control unit at the remote sensor (located on the right side of the display unit) when operating.
	Power won't turn on to the deck or CD receiver.	<ul style="list-style-type: none"> ● System cable connection is incorrect. 	<ul style="list-style-type: none"> ● Connect the system cable correctly.

- When the system is installed near a television set, magnetic influence from the speakers may cause the television's picture to be distorted. This symptom frequently occurs when using an indoor antenna; in this event, install an outdoor antenna, or separate the system farther from the television.
- Static electricity and other outside electrical influences may cause the system to operate incorrectly. In such cases, unplugging and reconnecting the power cord may help correct the problem.
- More than one of the same kind of component (CD receiver, MD recorder, or cassette deck) cannot be connected at the same time.

NOTE:**Setting the tuner's frequency interval**

FM broadcasts are normally tuned at 50kHz intervals and AM broadcasts at 9kHz intervals, but this setting can be changed to 100kHz (FM) and 10kHz (AM) if desired in the following way:

1. Turn the power off.
2. While holding the CD receiver's STOP button depressed, press the display unit's STANDBY/ON button to ON.

Repeat the above steps to return the tuner's frequency interval to its original setting.

SPECIFICATIONS

Stereo CD Receiver: XC-L7

Amplifier Section

Continuous Power Satellite (RMS)	30 W + 30 W
	(1 kHz, THD 10%, 8 Ω)
Continuous Power Subwoofer (RMS)	50 W
	(100 Hz, THD 10%, 4 Ω)
Continuous Power Satellite (DIN)	24 W + 24 W
	(1 kHz, THD 1%, 8 Ω)
Continuous Power Subwoofer (DIN)	41 W
	(100 Hz, THD 1%, 4 Ω)
Music Power Satellite (DIN)	40 W + 40 W
	(1 kHz, THD 1%, 8 Ω)
Music Power Subwoofer (DIN)	60 W
	(100 Hz, THD 1%, 4 Ω)

- Above specifications are for when the power supply is 230 V.

FM Tuner Section

Frequency Range	87.5 - 108MHz
Antenna	75 Ω, unbalanced

AM Tuner Section

Frequency Range	531 kHz - 1,602 kHz
	(9 kHz step);
	530 kHz - 1,700 kHz (10 kHz step)
Antenna	Loop antenna

Compact Disc Player Section

Type	Compact disc digital audio system
Usable discs	Compact discs
Channels	2 (stereo)
Frequency Response	4 Hz-20 kHz
Signal-to-Noise Ratio	110 dB (EIAJ)
Wow and Flutter	Limit of measurement
	(0.001%) or less (EIAJ)

Power Requirements	AC 230 V, 50/60 Hz
Power Consumption	95 W
Dimensions	220 (W) x 85 (H) x 310 (D) mm
Weight	4.0 kg

Accessories

Operating Instructions	1
Warranty Card	1
FM antenna	1
AM loop antenna	1
Remote control unit	1
Lithium battery (CR2025)	1
Remote control unit holder	1
Power cord	1
Display unit cord	1

Stereo Cassette Deck: CT-L7

System	4-track, 2-channel stereo
Heads	Recording/playback head x 1
	Erasing head x 1
Motor	DC Servo motor x 1
Frequency Response (-20dB recording)	
Type I (Normal) tape	20 Hz-16,000 Hz ± 6 dB
Type II (High/CrO ₂) tape	20 Hz-16,000 Hz ± 6 dB
Signal-to-Noise Ratio	56 dB
	(EIAJ, peak recording level,
	audio compensation)
Noise Reduction Effect	
Dolby B-type NR ON	More than 10 dB (at 5 kHz)
Wow and Flutter	0.07% WRMS
	±0.14% (DIN)
Dimensions	220 (W) x 85 (H) x 310 (D) mm
Weight	2.2 kg

Accessories

Supplementary Operating Instructions	1
Warranty Card	1

Speaker System: S-L7-LR/S-L7-A-LR (Satellite speakers)

Type	Phase-inversion (bass-reflex) type
Speaker Elements	70mm (cone type)
Nominal impedance	8 Ω
Frequency response	125 Hz-20,000 Hz
Maximum input (Music Power DIN)	30W
External dimensions ...	160 (W) x 170 (H) x 70 (D) mm
Weight	0.7 kg

Speaker System: S-L7-W/S-L7-A-W (Subwoofer)

Type ...	Phase-inversion (bass-reflex), bookshelf type
Speaker Elements	16cm (cone type)
Nominal impedance	4 Ω
Frequency response	22 Hz-4,400 Hz
Maximum input (Music Power DIN)	50 W
External dimensions	
.....	185 (W) x 280 (H) x 280 (D) mm
Weight	4.1 kg

Accessories

Satellite speaker cords	2
Subwoofer speaker cord	1
Subwoofer's non skid pads	4

NOTE:

Specifications and design subject to possible modification without notice, due to improvements.

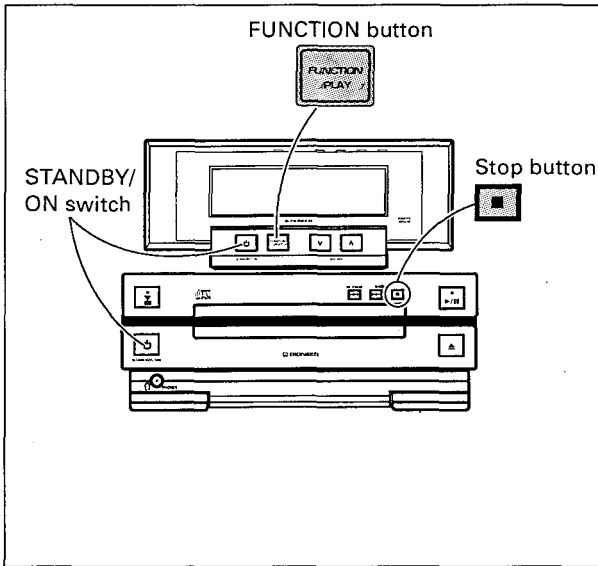

- When the default DEMO mode is on, supplying power after a power interruption (for example, when the power cord is first inserted into its outlet, or when power is restored after an interruption) will cause the DEMO mode to automatically begin.
The unit is factory set to a default of DEMO mode ON.
- During the DEMO mode display, pressing the STANDBY/ON switch on either the CD receiver, display unit, or remote control unit will cause the DEMO mode to be cancelled.
- To set the default DEMO mode to OFF:
 1. Turn power off.
 2. While holding the CD receiver's stop button (■) depressed, press the display unit's FUNCTION button (■).

The default DEMO mode can be turned ON by performing the above operation once again.

Published by Pioneer Electronic Corporation.
Copyright © 1997 Pioneer Electronic Corporation.
All rights reserved.

PIONEER ELECTRONIC CORPORATION 4-1, Meguro 1-Chome, Meguro-ku, Tokyo 153, Japan
PIONEER ELECTRONICS (USA) INC. P.O. BOX 1540, Long Beach, California 90801-1540
PIONEER ELECTRONICS OF CANADA, INC. 300 Allstate Parkway, Markham, Ontario L3R 0P2, Canada
PIONEER ELECTRONIC (EUROPE) N.V. Haven 1087 Keetberglaan 1, 9120 Melsele, Belgium, TEL: 03/570.05.11
PIONEER ELECTRONICS AUSTRALIA PTY. LTD. 178-184 Boundary Road, Braeside, Victoria 3195, Australia, TEL: [03] 9586-6300
PIONEER ELECTRONICS DE MEXICO S.A. DE C.V. San Lorenzo Num 1009 3er piso Desp. 302 Col. Del Valle, Mexico D.F. C.P. 03100 TEL:5-688-52-90