



Panasonic[®]

Operating Instructions Digital Progressive LCD TV

Model No. **TX-26LXD1**
TX-32LXD1



Please read these instructions before operating your set and retain them for future reference.

English

TQBC0767

Welcome

Dear Panasonic Customer,

We hope that you have many years of enjoyment from your new TV. The **Quick Start Guide** section at the beginning of this instruction book will allow you to use the TV as quickly as possible. We recommend that you then read the complete instruction book, and keep it to refer to as you explore the range of advanced features that this LCD TV offers.

Analogue and Digital television – what are they?

Analogue transmission is the system that has been used for many years for broadcasting television programmes. With continuous improvements in technology it is now possible to transmit programmes in a digital format, allowing clearer pictures, more stations and other services to be displayed on screen. Digital television is provided in three different ways; it can be sent along a cable connection direct to your house, broadcast from a satellite, or broadcast using traditional land based (terrestrial) transmitters. The first two options require you to have an extra “set top box” decoder and in the case of satellite, a receiving dish mounted outdoors. While allowing you to receive traditional analogue transmissions in the usual way, this television can also receive terrestrial digital services using an integrated **DVB** (Digital Video Broadcasting) decoder. This allows you to enjoy the new era of digital terrestrial television, including interactive services, without the need for a “set top box” or satellite dish – an adequate roof or loft mounted antenna is all you need.

Contents

Warnings and Precautions	3	DVB System Setup	21
Accessories	4	Common Interface Module menu	22
Fitting remote control batteries	4	Favourites Setup menu	23
Cable cover removal and fitting	5	Information banner	24
How to open the front cover	5	System Update menu	25
How to use the LCD stand	5	DVB Timer programming menu	26
Quick Start Guide	6	TV Guide	28
Basic controls: front panel and remote control	9	Q-Link	29
Using the On Screen Displays	10	Aspect Controls	30
Picture menu	11	Multi window	32
Sound menu	12	Picture and text	33
Setup menu	13	Photo View mode	34
Tuning menu – overview	14	VCR / DVD operation	38
Tuning menu – Programme edit	15	Teletext operation	39
Adding / deleting a programme channel	15	Audio / video connections	42
Moving a programme channel	15	How to connect the Headphones / AV3 terminals	42
Renaming a programme channel	16	How to connect the Audio Output terminals	43
Locking a programme channel	16	How to connect the AV1 / 2 / 4 Scart terminals	43
Copying programme information to a recording device	16	How to connect the Component Input terminals	43
Tuning menu – Auto setup	17	Troubleshooting	44
Tuning menu – Manual tuning	18	DVB Troubleshooting	45
Manual tuning (via front panel)	18	Maintenance	46
Shipping condition	19	Scart and S-video terminal information	46
Owner ID	20	Specifications	47

Warnings and Precautions

- This TV set is designed to operate on AC 220-240 V, 50 / 60 Hz.
- To prevent damage which might result in electric shock or fire, do not expose this TV set to rain or excessive moisture. This TV must not be exposed to dripping or splashing water and objects filled with liquid, such as vases, must not be placed on top of or above the TV.
- **WARNING : HIGH VOLTAGE!!!**
Do not remove the rear cover as live parts are accessible when it is removed. There are no user serviceable parts inside.
- **TV Games / Home Computers**
Extended use of TV games or home computers with any television set can cause a permanent 'shadow' on the screen. This type of irreversible LCD panel damage, can be limited by observing the following points:
 - Reduce the brightness and contrast levels to a minimum viewing level.
 - Do not allow a still picture to be displayed for an extended period, as this can cause a permanent after-image to remain on the LCD TV screen.
 - Examples of still pictures include logos, video games, computer images, teletext and images displayed in 4:3 mode.
 - This type of LCD panel damage, is not an operating defect, and as such is not covered by the Panasonic warranty.
- The On / Off switch on this model does not fully disconnect the TV from the mains supply. Remove the mains plug from the wall socket before connecting or disconnecting any leads, or if the TV set is not used for a prolonged period of time.

Note:

If the set is not switched off when the TV station stops transmitting, it will automatically go to Standby mode after 30 minutes. This function will not operate when the TV is in AV mode.

Cabinet and LCD panel care

Remove the mains plug from the wall socket. The cabinet and LCD panel can be cleaned with a soft cloth moistened with mild detergent and water. Do not use solutions containing benzol or petroleum.

- When ambient temperature is cool, the picture may take a short time to reach normal brightness, but this is not a malfunction. (After brief moment, the picture will have normal brightness.)
- Adequate ventilation is essential to prevent failure of electrical components, we recommend that a gap of at least 10 cm is left all around this television receiver even when it is placed inside a cabinet or between shelves.
- Avoid exposing the TV set to direct sunlight and other sources of heat. To prevent fire, never place any type of candle or naked flame on top or near the TV set.

FOR YOUR SAFETY PLEASE READ THE FOLLOWING TEXT CAREFULLY

This appliance is supplied with a fitted three pin mains plug for your safety and convenience. A 5 amp fuse is fitted in this plug. If the fuse is replaced then the replacement fuse must be 5 amp rated and should be approved by ASTA or BSI to BS1362.

Check for the ASTA mark  or the BSI mark  on the body of the fuse.

If the fitted plug has a removable fuse cover you must ensure that it is refitted when the fuse is replaced. If you lose the fuse cover the plug must not be used until a replacement cover is obtained. Replacement fuse covers can be purchased through your local Panasonic dealer.

The plug fitted to this appliance incorporates a mains filter circuit. If this is removed or replaced with a non- filtered plug this television will no longer meet the European standards for Electromagnetic Compatibility (EMC). If the fitted plug is unsuitable for the socket outlet in your home an appropriate adapter should be used.

Nonetheless, if the fitted plug is replaced, the fuse should be taken out and the cut-off plug disposed of safely. There is danger of severe electrical shock if the cut off plug is inserted into any 13 amp socket.

If a new plug is to be fitted please observe the wiring code as shown below.

If in any doubt please consult a qualified electrician.

How to replace the fuse (for plug type shown in example 1):

Lift out the removable fuse compartment with a screwdriver and replace the fuse, then refit securely into the mains plug (see example 1).

How to replace the fuse (for plug type shown in example 2):

Lift open the fuse compartment, in the mains plug, with a screwdriver, and replace the fuse, then press the fuse cover down securely (see example 2).

Example 1

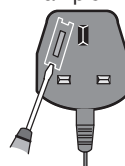

Example 2

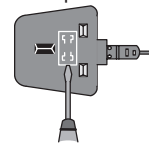

IMPORTANT :- The wires in the mains lead of this appliance are coloured in accordance with the following code :-
BLUE : NEUTRAL BROWN : LIVE

As the colours of the wires in the mains lead of this appliance may not correspond to the markings identifying the terminals in your plug, proceed as follows :-

1. The **BLUE** wire must be connected to the terminal marked 'N' or coloured black.
2. The **BROWN** wire must be connected to the terminal marked 'L' or coloured red.

IMPORTANT NOTE : Under no circumstances should either of these wires be connected to the Earth terminal of the three pin plug, marked with the letter 'E' or the earth symbol .

Accessories

Check that you have the accessories and items shown

Operating Instruction book
(TQBC0767)

Remote Control
Transmitter
(EUR7635010)

Batteries for the Remote
Control Transmitter
(2 × R6 (UM3) size)

TV Guarantee

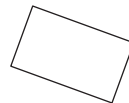
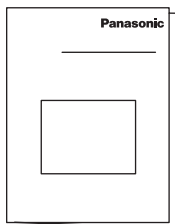

Fitting remote control batteries

1

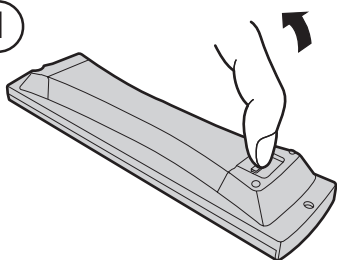

Pull and hold the hook, then open the battery cover.

2

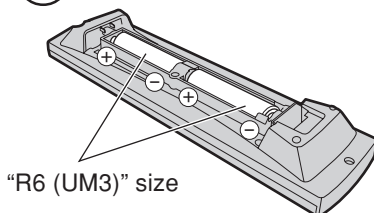

Insert batteries - note correct polarity (+ and -).

3

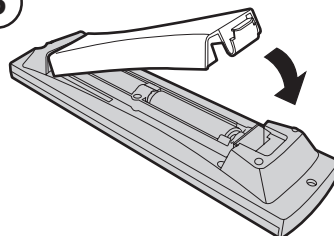

Replace the cover.

- Make sure that the batteries are fitted the correct way round.
- Do not mix old batteries with new batteries. Remove old, exhausted batteries immediately.
- Do not mix different battery types, i.e. Alkaline and Manganese or use rechargeable (Ni - Cad) batteries.

Batteries, packaging and old equipment should not be disposed of as domestic waste, but in accordance with the applicable regulations.



Cable cover removal and fitting

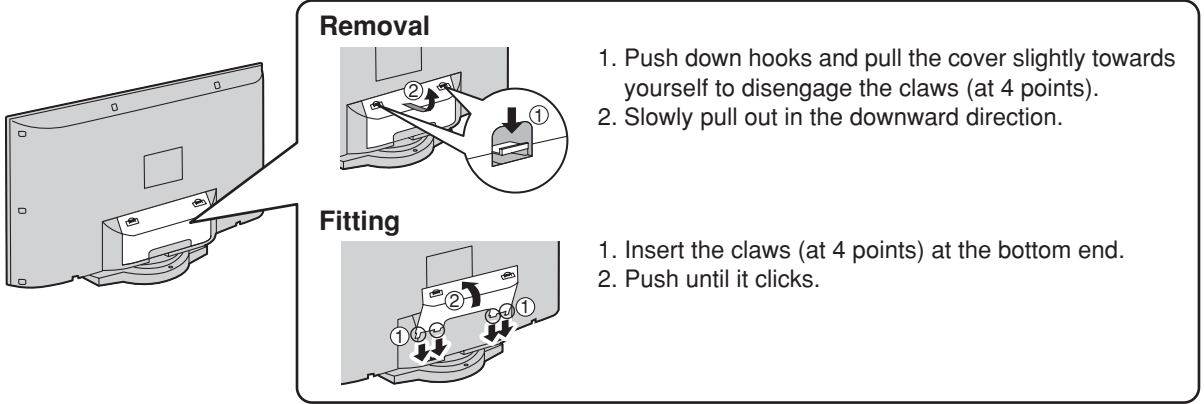

Note:

To avoid interference appearing on the screen, do not bundle the RF cable and mains lead together.

How to open the front cover

Lift up the cover where the mark “△” is shown.
Pull down to close the cover.

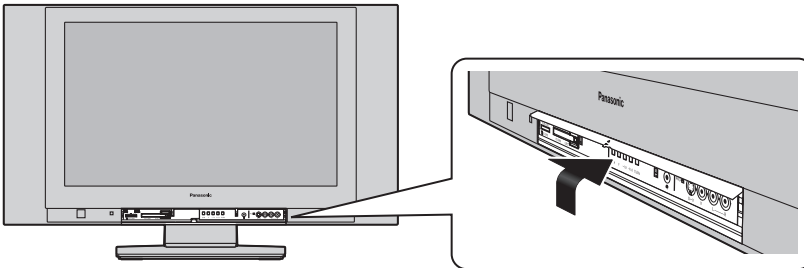

How to use the LCD stand

Adjust the LCD panel to your desired angle. The LCD panel can be swiveled up to 40° in the right-and-left direction.

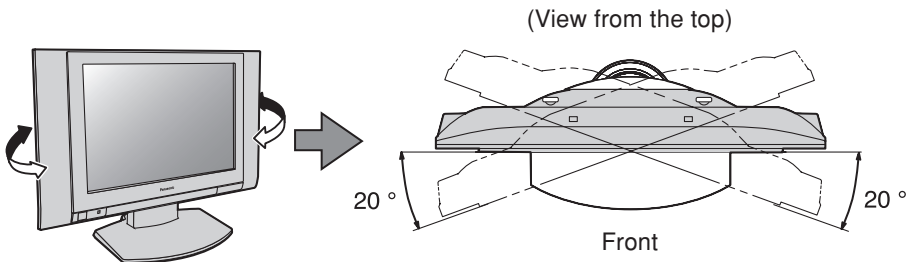

Note:

The LCD panel cannot be tilted forward and backward.

Quick Start Guide

Connection and setting up options

Note: Please ensure that the unit is disconnected from the mains before attaching or disconnecting any leads.

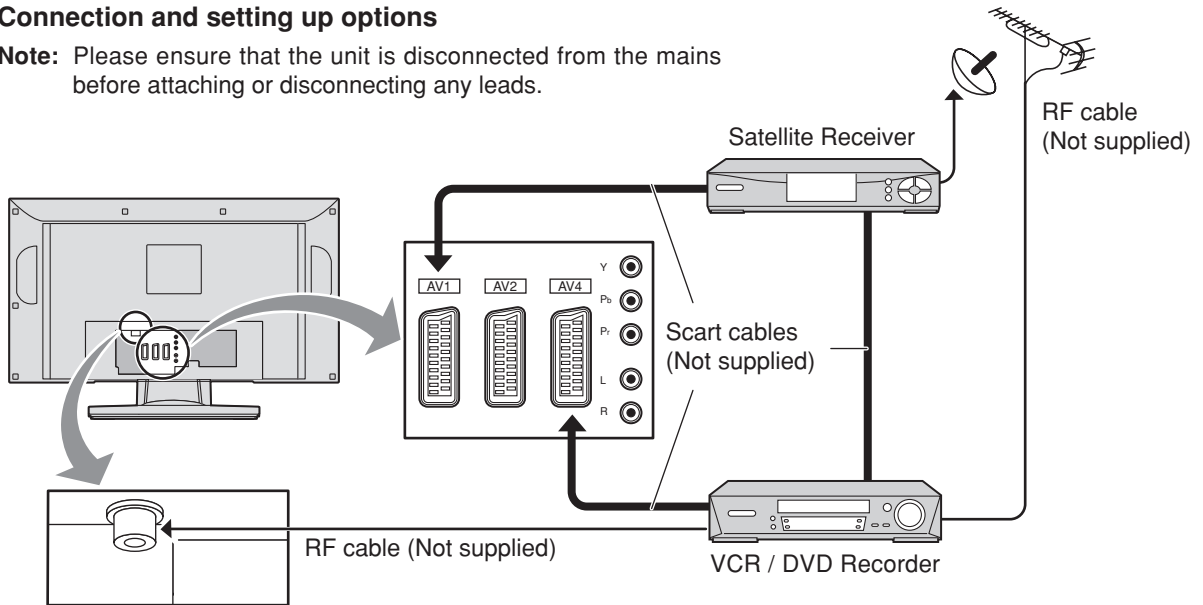

Scart Connections

- The VCR / DVD Recorder can be connected to the TV using a Scart cable, if you are using a Scart equipped VCR / DVD Recorder.
- Use the TV's any Scart terminal for any VCR. Always use a "fully wired" Scart cable.
- Use the TV's AV1 or AV4 Scart terminal for any DVD Recorder. Always use a "fully wired" Scart cable.
- Use the TV's AV1 or AV4 Scart terminal for Satellite Receiver. Always use a "fully wired" Scart cable.

RF Connection

- Connect the RF cable to the "Aerial In" terminal of the VCR / DVD Recorder and an RF cable from the VCR / DVD Recorder "Aerial Out" terminal to the TV Aerial terminal (㊦).



Notes:

- If using a "Q-Link" VCR / DVD Recorder, then the AV1 Scart of the VCR / DVD Recorder must be connected to the AV2 or AV4 terminal of the TV. If your VCR or DVD Recorder is not a "Q-Link" device, please consult the operating instruction book for that product. Further information on Q-Link can be found on page 29.
- Further details of Audio / Video connections can be found on page 42, 43.
- Additional equipment and cables are not supplied.

Quick Start Guide

1 Connect the mains plug to the wall socket.

Press the  switch on the TV set to turn the set on.

To switch the TV set to Standby mode, press the  button on the remote control. The TV set can be switched on by pressing the  button again if it was in Standby mode.

Note:

This TV will still consume some power even in the Off mode, as long as the mains plug is still connected to a live mains socket.

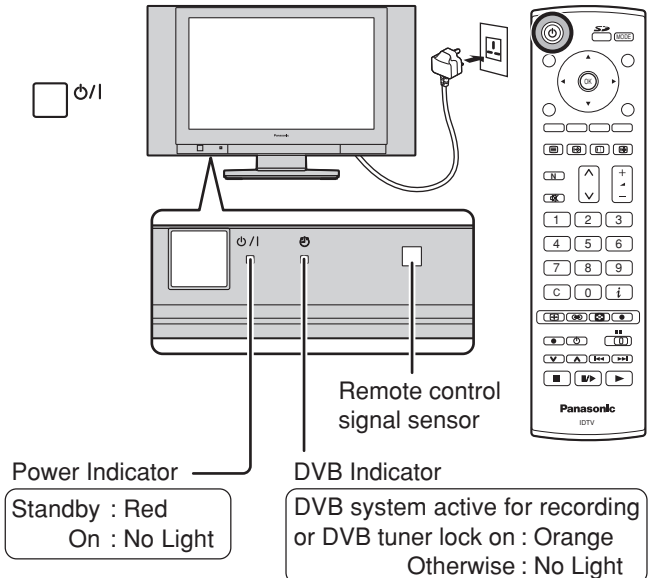

2 Programmes will appear immediately if your dealer has programmed the TV for you.

If the TV has not been programmed for you then **Auto setup** will begin.

The TV will search for Analogue stations and DVB stations:

TV stations will be located, sorted into order and stored ready for use.

Stations are sorted into the following order:

- **DVB Stations:** Are sorted by their logical channel number sent by the broadcasters, which cannot be moved or changed.
- **Analogue Stations:** Are sorted into channel order, but can be changed to your preference. See page 15.

The sorted programme order depends upon the TV signal, the broadcasting system, and reception conditions.

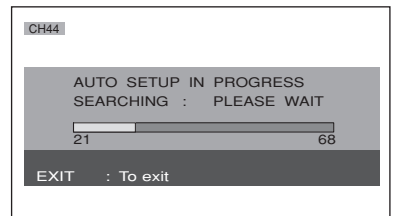

DVB Auto Setup					
Please wait ! 21  68					
Prog.	Channel	Service Name	Net ID	TS ID	Quality
46	40	BBC 5L Sportex	12302	16384	8
47	40	BBC R5 Live	12302	16384	8
48	40	CBeebies	12302	16384	8
49	40	BBC Four	12302	16384	8
50	40	BBC PARLINT	12302	16384	8

This will take about 3 mins.

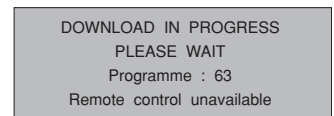

3 TV to VCR or DVD Recorder Download

If a "Q-Link", "NEXTVIEWLINK" or compatible recording device has been connected to a Scart terminal (AV2 or AV4) before starting Step 1, programme information will be downloaded to that device.

Only the analogue programme positions will be downloaded to the recording device, in the same order as stored in the TV. See page 29.

Not all VCRs / DVD Recorders support this download of programme information, some may require to be started manually.

Refer to the recording device's operating instruction book.

If a recording device other than those described above has been connected, then there will be no download operation.

Notes:

- If the recording device has not accepted download data from the TV, you may need to select the Download option from the device's menu system. Refer to the recording device's operating instruction book.
- If Q-Link is not operating correctly, check the following :
 - The Scart cable is connected to the TV's Scart terminal, AV2 or AV4, and correctly setup in the menu.
 - The Scart cable is connected to the recording device's compatible (Q-Link, NEXTVIEWLINK or similar technology) Scart terminal.
 - The Scart cable is a "fully wired" type.
- For further information on Q-Link and connecting equipment, see page 29, 43, 46.

Quick Start Guide

4

Owner ID

As an added feature, this TV has the option of adding a security code (Owner ID) and personal details into its memory, so that in the unfortunate event of theft it will help the Police to trace the owner.

Using the numeric buttons to enter required 4 digit Owner ID **PIN NUMBER**.

If a 4 digit **PIN NUMBER** was entered, you will be taken automatically to the **NAME** line.

If not, using the left or right cursor buttons move to the **NAME** line.

Change character using the up or down cursor buttons.

Select the character position using the left or right cursor buttons.

Repeat above until **NAME**, **HOUSE NUMBER** and **POSTCODE** are entered.

Press the **OK** button to store the details.

Press the **OK** button again, when you are asked "Are you sure ?".

For further information on Owner I.D., see page 20.

A space is provided on page 20 to write down the **PIN NUMBER** for future reference.

Your LCD TV is now ready for use.



5

To view a list of the stations that have been found, press the **GUIDE** button. See page 28.

Use the cursor buttons to move the cursor bar up and down the list.

Use the programme change button to step through the guide page by page.

To view the selected programme press the **OK** button.

Categories (DVB mode only)

To make stations easier to find, specific stations can be listed by category; press the left or right cursor button to choose a category. The chosen category name is shown on screen.

For example, if you select **Free TV**, only 'free-to-air' stations will be listed – you can view any of these now.

If you select **Pay TV**, only subscription stations will be listed – you will need to contact the service provider to find out how to subscribe to these stations.

A separate guide is available when viewing analogue mode. In this guide, use the cursor buttons to move the cursor bar around the list, use the programme change button to step through the guide page by page. Press the **OK** button to view the selected programme.

Both guides can be cleared from the screen using the **EXIT** button.

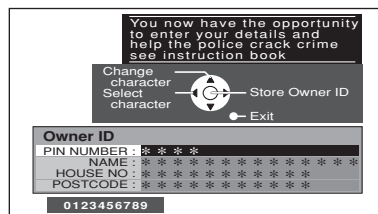

GUIDE

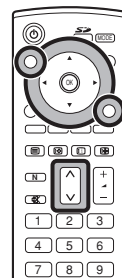

DVB TV Guide

DVB TV Guide						
Prog. Category						
All Services	Free TV	Pay TV	Radio			
1	2	3	4	5	6	7
Thu	Fri	Sat	Sun	Mon	Tue	Wed
EPG Date 14/08/03 Time 13 : 09						
1	BBC ONE			13 : 00	BBC News	
2	BBC 2			13 : 23	Wales Today	
3	ITV					
4	S4C					
5	flye					
6	ITV 2					
7	BBC THREE					

Analogue Programme Guide

Prog. Name	Chan.	Prog. Name	Chan.
VCR :	CH21	13	-
1 :	BBC1	CH44	14
2 :	BBC2	CH51	15
3 :	ITV	CH41	16
4 :	S4C	CH47	17
5 :		CH23	18
6 :		CH26	19
7 :		CH58	20
8 :	-	21	-
9 :	-	22	-
10 :	-	23	-
11 :	-	24	-
12 :	-	-	-

Basic controls: front panel and remote control

F (Function select)

Displays the On Screen Display functions, use repeatedly to select from the available functions - **Volume, Backlight, Contrast, Brightness, Colour, Sharpness, Tint** (in NTSC mode), **Bass, Treble, Balance and Tuning mode**.

STR (Normalization store)

Used to store tuning and other function settings.

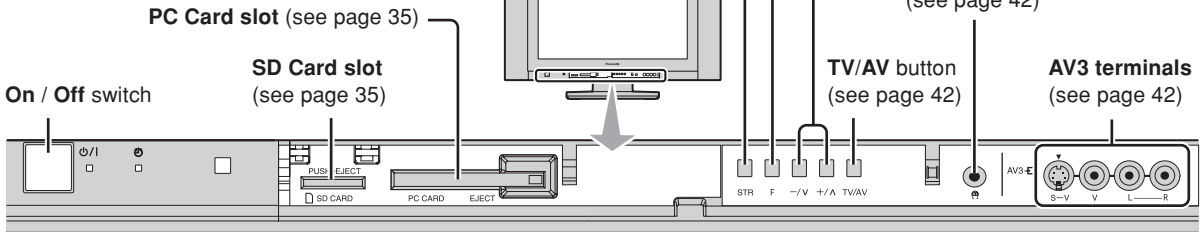

Increases or decreases the programme position by one. When a function is already displayed, press to increase or decrease the selected function. When in **Standby mode**, switches TV **On**.

Standby On / Off button

Switches TV **On** or **Off** (Standby mode).

GUIDE button

Displays the DVB and Analogue TV Guide. (see page 28)

Cursor buttons to make selections and adjustments.

Menu button

Press to access the **Picture, Sound and Setup** menus. (see page 10-13)

Teletext button (see page 39-41)

STTL button (see page 21)

Text F.P. button (Analogue mode) (see page 40)

N (Normalize) button

Resets all settings to their default levels.

Channel up / down button

Sound mute On / Off

Direct channel access (Analogue mode only)

During normal TV viewing or when in the **Tuning, Programme edit** or **Manual tuning** menus, press and then enter channel number using the numeric buttons.

ASPECT control button (see page 30, 31)

Ambience On / Off (see page 12)

Photo View mode button (see page 37-40)

MODE button (see page 12, 13)

Switch between viewing DVB and Analogue modes.

Switch between viewing TV or AV input. (see page 42)

Press to confirm selections and choices. Press after selecting programme positions 1-99 (0-9 in Analogue mode) to avoid delay.

Exit the mode.

Coloured buttons used for the selection, navigation and operation of various functions.

Text Hold button (see page 39)

Text Index button (see page 41)

Volume up / down button

Programme / channel change buttons (0-9) and Teletext page buttons. (see page 39-41)

When in **Standby mode**, switches TV **On**.

Status button

Press to display status information for the current Programme position. (see page 24)

DIRECT TV Record button (see page 29)

MULTI WINDOW button (see page 32, 33)

VCR / DVD buttons (see page 38)



Using the On Screen Displays

Many features available on this TV can be accessed via the On Screen Display menu system. Use the remote control as shown below to access and adjust features as desired.

The **MENU** button is used to open the main menus and also to return to the previous menu.

The up and down cursor buttons are used to move the cursor and select menus.

The left and right cursor buttons are used to access menus, adjust levels or to select from a range of options.

The **OK** button is used with a number of features to store settings after adjustments have been made or options have been set.

The **EXIT** button is used to exit the menu system and return to the normal viewing screen.

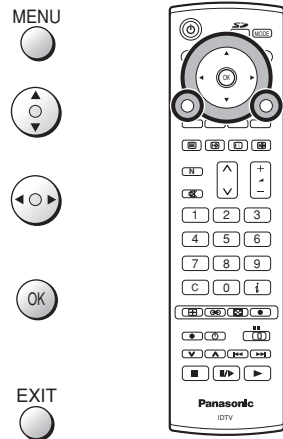

An On Screen Help box is displayed whenever a menu is displayed on the TV. This Help box indicates which buttons on the remote control are used to navigate the menu shown, see above for descriptions of button functions.

Note:

The Help box is not shown in the menu pictures in this instruction book due to space limitations.

ON SCREEN HELP 'Instructions' box

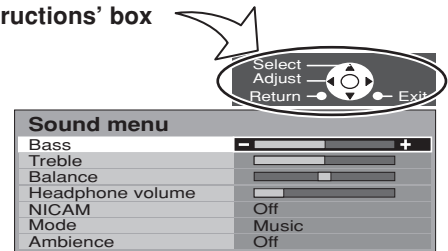

Picture menu

Press the **MENU** button.

Move to choose **Picture menu**.

Access **Picture menu**.

Move to choose menu option.

Adjust chosen option or access chosen menu.

Press the **EXIT** button at any time to go back to watching TV.

MENU



EXIT

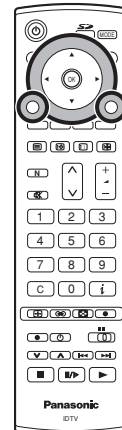

Viewing mode

The Viewing mode menu allows you to select three different screen settings - **Dynamic**, **Normal** and **Cinema**.

In each Viewing mode setting, Backlight, Contrast, Brightness, Colour, Sharpness, Tint (in NTSC only), Colour balance, P-NR and 3D-COMB can be adjusted and stored to suit your particular viewing requirement. (e.g., you may require different settings for viewing sports, films, news etc.)

Changes to any settings in a viewing mode will affect all signal sources: RF, AV1, AV2, AV3 and AV4. Changes will be stored automatically.

By analysing and processing the incoming picture, all three modes feature automatic enhancement.

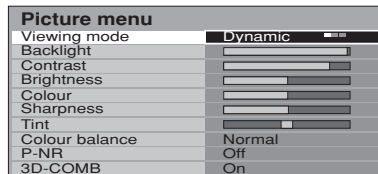
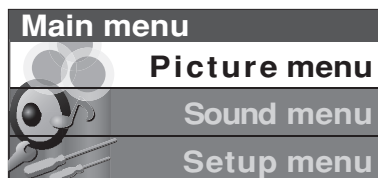

Backlight, Contrast, Brightness, Colour, Sharpness

Increase or decrease the levels of these options according to your personal preference.

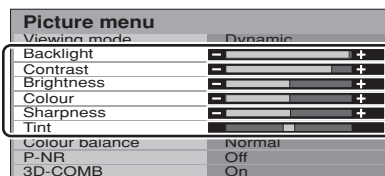

Tint

With an NTSC signal source connected to the TV, the picture hue can be adjusted to suit your taste.

Colour balance

Allows you to set the overall colour tone of the picture. Choose from **Cool**, **Normal** and **Warm**.

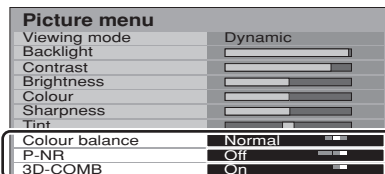

P-NR

Automatically reduces unwanted picture noise.

3D-COMB

Not available in DVB mode. Occasionally, whilst viewing still or slow moving pictures, colour patterning may be seen. Set 3D-COMB to **On** to display sharper and more accurate colours. Displayed only when receiving PAL or NTSC signals. Not displayed during RGB Video, S-Video input and AV4C input mode.

Sound menu

Press the **MODE** button to select DVB or Analogue mode.

Press the **MENU** button.

Move to choose **Sound menu**.

Access **Sound menu**.

Move to choose menu option.

Adjust chosen option or access chosen menu.

Press the **EXIT** button at any time to go back to watching TV.

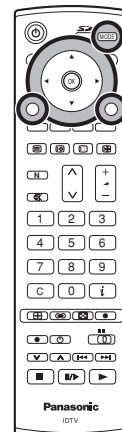

Bass Increase or decrease level to enhance or minimise lower, deeper sound output.

Treble Increase or decrease level to enhance or minimise sharper, higher sound output.

Balance The levels of sound between the left and right speakers can be adjusted to suit your listening position.

Headphone volume Can be adjusted independently of the TV speakers so that everyone can enjoy listening at a level comfortable for them.

NICAM Not available in DVB mode.
Select **On** to provide stereo sound reproduction. Select **Off** for FM Mono sound output.
If Nicam Mono is being transmitted select either FM Mono (Off), Nicam Mono I (M1) or Nicam Mono II (M2). The options depend upon the signal being transmitted. If reception deteriorates it is advisable to switch to FM Mono (Off).

Multi audio Multi audio, which will only appear when a DVB programme is selected, allows you to select an alternative sound track. The number of options available depends on each broadcast.

Mode Sound quality can be improved when watching music scene or drama by selecting the appropriate **Music** or **Speech** mode.

Ambience Ambience provides a dynamic enhancer to simulate improved spatial effects.

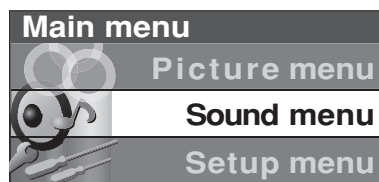

Analogue mode

Sound menu	
Bass	— ———— +
Treble	———— ———
Balance	———— ———
Headphone volume	———— ———
NICAM	Off
Mode	Music
Ambience	Off

DVB mode

Sound menu	
Bass	— ———— +
Treble	———— ———
Balance	———— ———
Headphone volume	———— ———
Multi Audio	No service
Mode	Music
Ambience	Off

Setup menu

Press the **MODE** button to select DVB or Analogue mode.

Press the **MENU** button.

Move to choose **Setup menu**.

Access **Setup menu**.

Move to choose menu option.

Adjust chosen option or access chosen menu.

Press the **EXIT** button at any time to go back to watching TV.

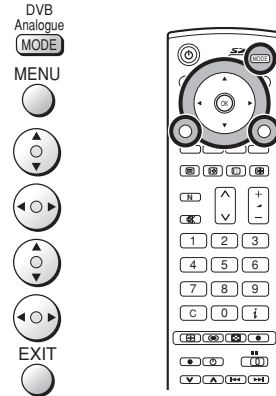

Q-Link Allows you to select which AV terminal is to be used for data communication between this TV and a compatible recording device. Choose from **AV2** and **AV4**. See page 29.

AV2 / AV4 out Offers a choice of signals to send to the Scart terminal selected in the Q-Link option. You can choose from the current TV (**Analogue**, **DVB**) programme position, the signal entering **AV1 / AV2 / AV3 / AV4** or **Monitor** - the picture displayed on screen.

Teletext Allows you to choose between **FASTTEXT** or **List** mode. See page 39-41.

Off timer Switches the TV off within a preset time which you can choose from between 0 to 90 minutes in 15 minute intervals.

Power on preference Set to **TV** to view picture from TV tuner. Set to **AV** to view input from an external equipment connected to a Scart socket, e.g. satellite receiver.
Note: The external equipment must be switched on and sending a control signal for automatic switching at power on to occur.

Analogue Tuning Menu Provides access to many other features including **Programme edit** and **Auto setup**. See page 15-17.

DVB Timer Programming Allows you to enter programme times at which the DVB tuner must switch on, ready for recording. See page 26.

DVB Tuner lock Prevents you from accidentally changing programme position while recording a DVB broadcast. If the TV is switched into standby mode while DVB tuner lock is on, the DVB tuner will remain active to ensure recording can still take place.

DVB Auto Setup Allows you to clear all current digital tuning data, and scan for new services. See page 17.

DVB System Setup Provides access to various specialised DVB options. See page 21.

New Service Message This TV continually scans for updated DVB services and notifies you of any changes. Set to **On** to receive notification. Set to **Off** if you do not wish to be informed of any updates.

Shipping condition Allows you to clear all tuning information and reset all control levels back to factory settings. See page 19.

Child Lock You may wish to lock a DVB programme channel to prevent access to it. Set to **On** to lock the current programme position. Set to **Off** to unlock. When a programme position is locked, Direct Channel Access using the **C** and numeric keys on the remote control is not available.

Volume correction During AV mode, Volume correction is displayed. You can adjust volume level of AV mode. Volume level is memorised.

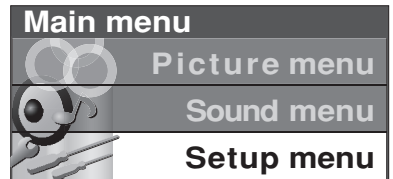

Analogue TV mode

Setup menu	
Q-Link	AV2
AV2 out	Monitor
Teletext	FASTTEXT
Off timer	Off
Power on preference	TV
Analogue Tuning Menu	

DVB mode

Setup menu	
DVB Timer programming	Access
DVB Tuner lock	Off
DVB Auto Setup	
DVB System Setup	
New Service Message	Off
Shipping condition	
Q-Link	AV2
AV2 out	Monitor
Off timer	Off
Child lock	Off
Power on preference	TV

AV mode

Setup menu	
Q-Link	AV2
AV2 out	Monitor
Teletext	FASTTEXT
Off timer	Off
Volume correction	
Power on preference	TV

Tuning menu – overview

During Analogue mode

Press the **MENU** button.

Move to choose **Setup menu**.

Access **Setup menu**.

Move to choose **Analogue Tuning Menu**.

Access **Analogue Tuning Menu**.

Move to choose menu option.

Adjust chosen option or access chosen menu.

Press the **EXIT** button at any time to go back to watching TV.

Press the **OK** button after having adjusted some features to store the new settings as the default (replacing the factory setting).

MENU

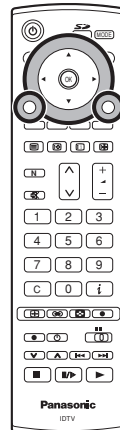

Programme edit Access in order to customize your programme settings (e.g., adding or deleting a programme position). See page 15, 16.

Auto setup Allows you to automatically retune the TV. Useful if you move house and wish to retune your TV to the local stations. See page 17.

Manual tuning Allows individual programme positions to be tuned manually. See page 18.

Shipping Condition Allows you to clear all tuning information and reset all control levels back to factory settings. See page 19.

Owner ID Allows you to enter a security code and address information. See page 20.

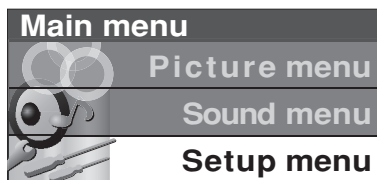

Setup menu	
Q-Link	AV2
AV2 out	Monitor
Teletext	FASTEXT
Off timer	Off
Power on preference	TV
Analogue Tuning Menu	Access

Analogue Tuning Menu	
Programme edit	Access
Auto setup	
Manual tuning	
Shipping condition	
Owner ID	

Programme edit			
Prog.	Chan.	Name	Lock
1	CH44	ABC	Off
2	CH51	XYZ	Off
3	CH41	FTP	Off
4	CH47	123	Off
5	CH37	456	Off

Delete	Add	Move	Download
--------	-----	------	----------

Tuning menu – Programme edit (Analogue mode only)

During Analogue mode

Press the **MENU** button.

Move to choose **Setup menu**.

Access **Setup menu**.

Move to choose **Analogue Tuning Menu**.

Access **Analogue Tuning Menu**.

Move to choose **Programme edit**.

Access **Programme edit**.

Move to choose programme position (e.g., Prog. 3).

Make required change, e.g., moving a programme channel (see the relevant procedure below).

Press the **EXIT** button at any time to go back to watching TV.

Press the **OK** button after having adjusted some features to store the new settings.

MENU



EXIT



OK



Adding / deleting a programme channel

Move the cursor to the programme to be deleted or added.

Press the **Green** button to add a programme channel to the programme position, or the **Red** button to delete one.

Press the same button again to confirm your decision.



Programme edit			
Prog.	Chan.	Name	Lock
1	CH44	ABC	Off
2	: CH51	XYZ	Off
3	: CH41	FTP	Off
4	: CH47	123	Off
5	: CH37	456	Off

Add Cancel

Moving a programme channel

Move the cursor to the programme to be moved.

Press the **Yellow** button.

Choose the new position for the programme channel.

Press the **Yellow** button again to confirm your decision.



Programme edit			
Prog.	Chan.	Name	Lock
1	CH44	ABC	Off
2	: CH51	XYZ	Off
3	: CH41	FTP	Off
4	: CH47	123	Off
5	: CH37	456	Off

Confirm Cancel

Tuning menu – Programme edit (Analogue mode only)

Renaming a programme channel

Move to the **Name** column.



Choose the new character. The box at the bottom of the screen shows the character currently selected.



Move to the next character position.



Continue until renaming is done.

Press the **OK** button to store the new name.



Programme edit			
Prog.	Chan.	Name	Lock
1	: CH44	█	Off
2	: CH51	XYZ	Off
3	: CH41	FTP	Off
4	: CH47	123	Off
5	: CH37	456	Off

ABCDEFGHIJKLMNQRST
UVWXYZ+- 0123456789

Locking a programme channel

You may wish to lock a programme channel to prevent access to it.

Move to the **Lock** column.



Choose between Lock **On** or Lock **Off**.



Press the **OK** button to store the new setting.



Programme edit			
Prog.	Chan.	Name	Lock
1	: CH44	ABC	Off
2	: CH51	XYZ	Off
3	: CH41	FTP	Off
4	: CH47	123	Off
5	: CH37	456	Off

Note:

When a programme position is locked, Direct Channel Access using the **C** and numeric buttons on the remote control is not available.

Copying programme information to a recording device

You can copy programme information to a compatible recording device connected to AV2 / AV4. See page 43 for connection information.

Press the **Blue** button.

Programme data will now be sent to the recording device(s). This might take a few seconds, depending on the number of stations stored. If the message "Feature not available" appears on the screen, the television is unable to send the programme information to the recording device(s). See the device's instruction book for further information.



Blue

<p>DOWNLOAD IN PROGRESS PLEASE WAIT Programme : 63 Remote control unavailable</p>

Tuning menu – Auto setup

Auto setup automatically retunes your TV. This feature is useful if, e.g., you move house and wish to retune your TV to receive the local stations.

Analogue Auto setup (During Analogue mode)

Press the **MENU** button.

Move to choose **Setup menu**.

Access **Setup menu**.

Move to choose **Analogue Tuning Menu**.

Access **Analogue Tuning Menu**.

Move to choose **Auto setup**.

Access **Auto setup**.

Press to start **Auto setup**.

MENU



DVB Auto setup (During DVB mode)

Press the **MENU** button.

Move to choose **Setup menu**.

Access **Setup menu**.

Move to choose **DVB Auto Setup**.

Access **DVB Auto Setup**.

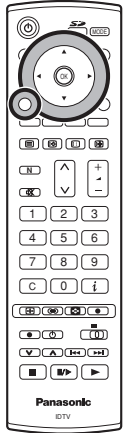

Notes:

- If you proceed with the next step all tuning data will be erased (all stations and their programme positions stored in your TV's memory will be wiped out so the new settings can be stored).
- If you exit the procedure after this point and before **Auto setup** is complete, no station information will be stored. Restart and complete the Auto setup procedure so that the TV is retuned.

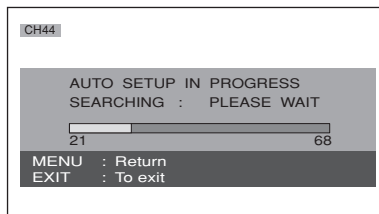
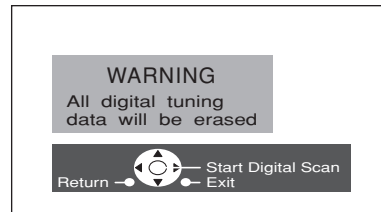
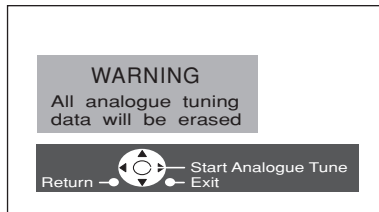

DVB Auto Setup					
Please wait !					
21 68					
Prog.	Channel	Service Name	Net ID	TS ID	Quality
46	40	BBC 5L Sportex	12302	16384	8
47	40	BBC R5 Live	12302	16384	8
48	40	Cbeebies	12302	16384	8
49	40	BBC Four	12302	16384	8
50	40	BBC PARLINT	12302	16384	8

This will take about 3 mins.

The TV will search for, locate, store and then sort into order your local stations.

If compatible recording device is connected via the AV2 / AV4 terminal, programme data will be sent to the device via Q-Link. See page 29.

Once this operation is completed the TV will display the programme now stored on programme position 1.

Tuning menu – Manual tuning (Analogue mode only)

It is possible to retune individual programme positions:

During **Analogue mode**

Press the **MENU** button.

Move to choose **Setup menu**.

Access **Setup menu**.

Move to choose **Analogue Tuning Menu**.

Access **Analogue Tuning Menu**.

Move to choose **Manual tuning**.

Access **Manual tuning**.

Select the programme position to be tuned.

Press repeatedly until required station is found.

When the desired station is found, press the **OK** button to store. The programme position will flash.

Press the **EXIT** button at any time to go back to watching TV.

Note:

If your VCR is connected to this TV by an RF cable only, choose programme position "0" to tune to the VCR signals.

MENU

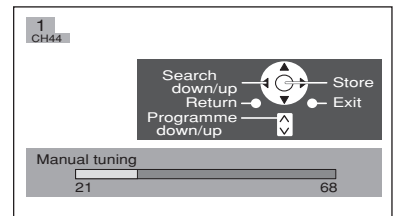

Manual tuning (via front panel) (Analogue mode only)

It is also possible to use the control panel buttons on the front of your TV to tune individual programme positions:

Press the **F** button until **Tuning mode** is reached.

Press the **-/V** or **+/\A** button to access **Tuning mode**.

Press the **TV/AV** button to move between **Change programme** and **Search**.

Press the **-/V** or **+/\A** button to change programme position or start search.

When the desired station is found, press the **STR** button to store. The programme position will flash.

Repeat above procedure to tune additional programme positions.

Press the **F** button at any time to go back to watching TV.



F



STR



F

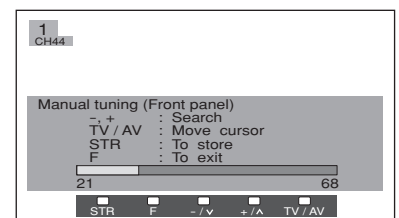
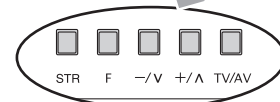
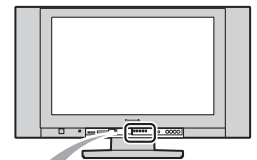

Shipping condition

Shipping condition allows you to reset the TV to its original condition, i.e. no channels tuned in. This is useful, for example, if you move to a different area when you will probably want the TV to tune itself to your new local stations.

This can be done either through the **Shipping condition** menu or through the **Auto setup** menu.

The **Shipping condition** menu will reset all data, clearing all analogue and DVB tuning information and resetting all control levels back to factory settings. You may need to adjust your VCR or programme position '0' VCR after operating the **Shipping condition** menu.

During Analogue or DVB mode

Press the **MENU** button.

Move to choose **Setup menu**.

Access **Setup menu**.

Move to choose **Analogue Tuning Menu**.
(In DVB mode, choose Shipping condition, then press **OK**.)

Access **Analogue Tuning Menu**.

Move to choose **Shipping condition**.

Access **Shipping condition**.

Press **OK** to start.

Press again, to confirm, each time that you are asked, "Are you sure?"

Switch the TV off at the mains power switch.

The next time you switch the TV on, Auto setup will begin. Analogue and DVB stations will be located, sorted and stored ready for use. See page 17.

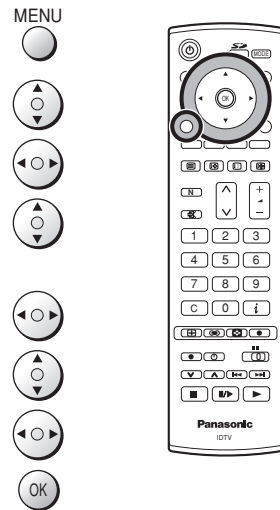

Analogue Tuning Menu	
Programme edit	
Auto setup	
Manual tuning	
Shipping condition	Access
Owner ID	

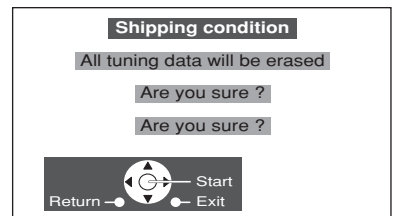

Owner ID

Owner ID allows you to enter a security code(Owner ID) and personal details into its memory, so that in the unfortunate event of theft it will help the police to trace the owner.

If you wish to check the personal details already entered into the TV (except your PIN number), press the **F** button(Front panel) and hold for 6 seconds(initially the volume level function will appear, as you continue to hold down the **F** button it will disappear again, and the Owner ID information will appear). The details already entered are displayed on screen and will disappear after a few seconds.

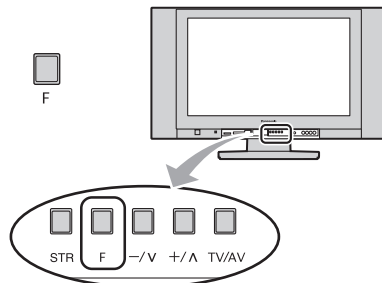

If **Owner ID** information was not entered when you switched on your TV for the first time or it is necessary to alter some of the information, **Owner ID** can be re-accessed via the **Analogue Tuning Menu**.

During Analogue mode

Press the **MENU** button.

Move to choose **Setup menu**.

Access **Setup menu**.

Move to choose **Analogue Tuning Menu**.

Access **Analogue Tuning Menu**.

Move to choose **Owner ID**.

Access **Owner ID**.

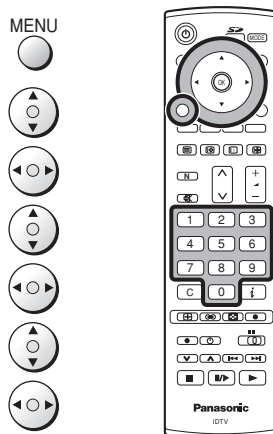

If the **Owner ID** has previously been set, enter the **PIN NUMBER** (using 0 to 9 on the remote control) followed by **OK** to proceed, this will take you to the **NAME** option.

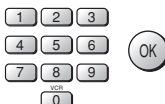

If no **Owner ID** has previously been set, enter the required 4 digit **Owner ID PIN NUMBER** (using 0 to 9 on the remote control).



If a 4 digit **PIN NUMBER** was entered above, you will be taken automatically to the **NAME** line.

If not, move to the **NAME** line.



Change character.



Select character position.



Repeat above until **NAME**, **HOUSE NUMBER** and **POSTCODE** are entered.

Press **OK** to store the details.



Press again when you are asked, "Are you sure?".

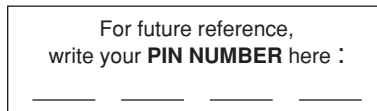
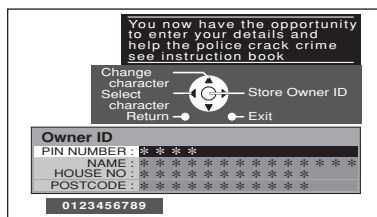
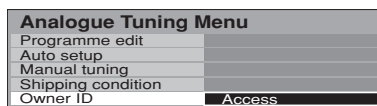

DVB System Setup

The DVB System Setup menu provides access to DVB specific options.

Note: If DVB transmissions cannot be received clearly, the DVB System Setup menu may not be available.

During **DVB mode**

Press the **MENU** button.

Move to choose **Setup menu**.

Access **Setup menu**.

Move to choose **DVB System Setup**.

Access **DVB System Setup**.

Move to choose menu option.

Adjust chosen option or access chosen menu.

Press the **EXIT** button at any time to go back to watching TV.

Pressing the **OK** button after having adjusted some features will store the setting as the default (replacing the factory setting).

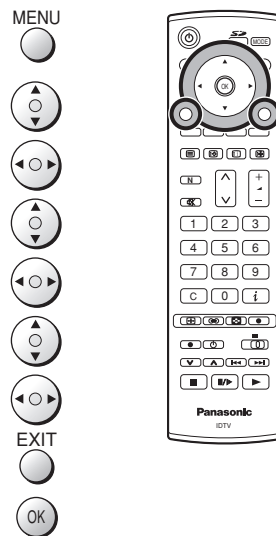

Signal Quality

The signal quality function displays an indication of signal quality for each DVB programme position.

The DVB system requires a good quality signal to provide the best picture. When viewing analogue pictures, interference such as signal reflection from nearby buildings or mountains causes 'ghosting', but still provides a viewable picture. For the DVB system, interference such as this can disrupt the flow of data causing the picture to appear to be made up of large blocks, or to freeze intermittently. If the picture disappears completely, this could mean that signal quality is very poor. If this happens often, you may need to improve your aerial system to provide a better signal.

Common Interface Module

The Common Interface Module menu provides access to functions contained on a Common Interface Module inserted into the CI slot, located at the rear of the TV. See page 22.

Favourites Setup

Allows you to select your favourite programme positions and display them as a list in the TV Guide. See page 23.

Preferred Subtitles

This option allows you to select the language in which subtitles should appear (if available) when the **STTL** button is pressed.

System Update

This menu allows you to download new software to the television. See page 25.

Display Timeout

This option allows you to set how long the information banner stays on screen. Select from 0 (no display) to 10 seconds in 1 second increments.

Screensaver Active

This option allows you to set the time the screensaver starts. This is for preventing image retention. Select from Off (no screensaver), After 1, 2, 5 minutes. This option is available for DVB mode.

There are 2 types of Screensaver:

- Scrolling "Panasonic" display - When there is no signal connected and no TV operations.
- Dimmed picture - When viewing digital text or listening to radio channels.

Settings

Changes made within the DVB-Setup menu will cause settings to change from "Default" to "User defined". To return to the default settings for this TV, select "Default", then press **OK** to store your setting.

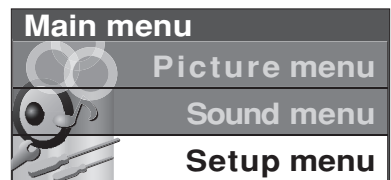

Setup menu	
DVB Timer programming	
DVB Tuner lock	Off
DVB Auto Setup	
DVB System Setup	Access
New Service Message	Off
Shipping condition	
Q-Link	AV2
AV2 out	Monitor
Off timer	Off
Child lock	Off
Power on preference	TV

DVB System Setup	
Signal Quality	Access
Common Interface Module	
Favourites Setup	
Preferred Subtitles	English
System Update	
Display Timeout	3 seconds
Screensaver Active	After 2 minutes
Settings	Default

Common Interface Module menu

The Common Interface Module menu provides access to software contained on Common Interface (CI) Modules. These can be inserted in the "CI" slot located at the rear of the TV.

IMPORTANT NOTES:

- Switch off the TV using the front panel switch before inserting or removing a module.
- If you are installing a TV software update, please follow the dedicated instructions supplied with the module.
- Insert / remove a module straightly to the CI slot.

Insert the CI module:

Some Common Interface Modules may be a two piece design consisting of a card reader together with the viewing card. When using this design of card, first insert the card reader firmly into the CI slot on the TV. Secondly, insert the viewing card into the reader.

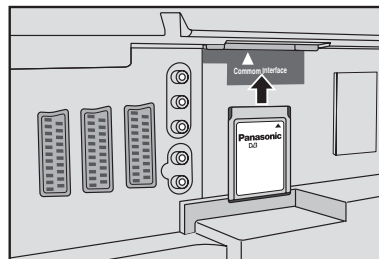

Switch on the TV.

During DVB mode

Press the **MENU** button.

Move to choose **Setup menu**.

Access **Setup menu**.

Move to choose **DVB System Setup**.

Access **DVB System Setup**.

Move to choose **Common Interface Module**.

Access **Common Interface Module**.

Access the module.

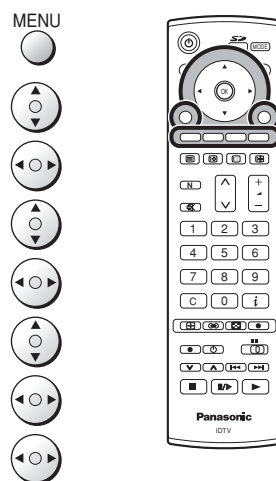

If no module is inserted the message "No Module Inserted" will be displayed.

(If you have inserted a module, check that it is fully inserted.)

The features that now appear on screen are dependent on the contents of the selected Common Interface Module.

Refer to the instructions supplied with the card or contact the vendor.

In all cases, it is possible to navigate the pages using buttons on the remote control, but because the commands available must apply to all manufacturers of DVB equipment, some on screen commands may not correspond exactly to the remote control buttons.

For example:

For the on screen command 'select' or 'go', use the **OK** button.



If you see the ◀▶▼▲ symbols, use the cursor keys.



If you see a line of key words displayed in red, green, yellow and blue, use the coloured buttons to operate the functions.



The **EXIT** button should always allow you to exit the CI software.

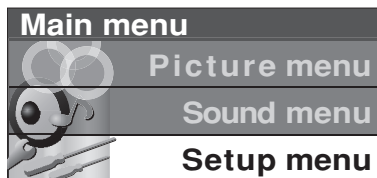

Setup menu	
DVB Timer programming	Off
DVB Tuner lock	Off
DVB Auto Setup	Off
DVB System Setup	Access
New Service Message	Off
Shipping condition	Off
Q-Link	AV2
AV2 out	Monitor
Off timer	Off
Child lock	Off
Power on preference	TV

DVB System Setup	
Signal Quality	Off
Common Interface Module	Access
Favourites Setup	Off
Preferred Subtitles	English
System Update	Off
Display Timeout	3 seconds
Screensaver Active	After 2 minutes
Settings	Default

Common Interface	
Slot 1: No module inserted	Access

Favourites Setup menu (DVB mode only)

The Favourites Setup menu allows you to select your favourite programme positions and display them as a list in the TV Guide, to allow quick and easy access to the programs you watch most often.

During DVB mode

Press the **MENU** button.

Move to choose **Setup menu**.

Access **Setup menu**.

Move to choose **DVB System Setup**.

Access **DVB System Setup**.

Move to choose **Favourites Setup**.

Access **Favourites Setup**.

Move to the programme position which you wish to set as a favourite.

Press the **OK** button to set your favourite.

A tick appears next to the selected program position.

You may move to and select as many programme positions as you wish.

To clear a previously selected favourite, select it with the cursor bar and press the **OK** button.

Press the **MENU** button to return to the DVB-Setup menu.

Press the **EXIT** button at any time to exit Favourites Setup.

A list of favourites can be accessed by pressing the **GUIDE** button. See page 28.

MENU

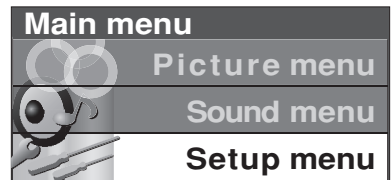
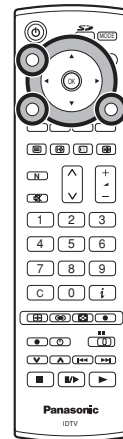

Setup menu	
DVB Timer programming	Off
DVB Tuner lock	Off
DVB Auto Setup	
DVB System Setup	Access
New Service Message	Off
Shipping condition	
G-Link	AV2
AV2 out	Monitor
Off timer	Off
Child lock	Off
Power on preference	TV

DVB System Setup	
Signal Quality	
Common Interface Module	
Favourites Setup	Access
Preferred Subtitles	English
System Update	
Display Timeout	3 seconds
Screensaver Active	After 2 minutes
Settings	Default

Information banner

In DVB mode

The Information banner provides access to information on current and upcoming programmes and easy switching between all channels or just those in your Favourites list.

Press the **i** (Information) button.

An information banner will appear with details of the current programme being broadcast. These details may include the channel number and programme position, the title and duration of the current or next programme, details of transmitted support services (for example text, multi audio, subtitles) and the current time.

You can set how long the information banner stays on screen when you change TV channel. See page 21.

Use the cursor up and down buttons to scroll through the programme list.

If you have set favourite channels and want to scroll through only those channels, press the **Blue** button.

To step through your favourite channels press the **Blue** button repeatedly.

Further information on the individual programmes shown can be displayed by pressing the **i** (Information) button.

To return to the normal Information banner view press the **i** (Information) button once more, alternatively, press the **EXIT** button to return to normal viewing mode.

For information on the upcoming (next) programme on any individual channel, press the left or right cursor button.

To select any programme listed in the Information banner press the **OK** button.

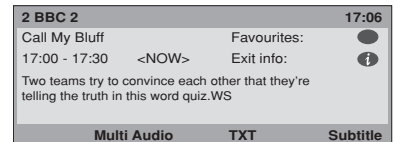
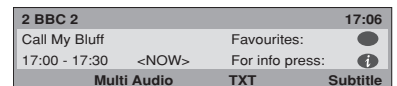

In Analogue mode

Pressing the **i** (Information) button will display the analogue channel information for a few seconds. This will then be timed out to display just the programme position number near the top left corner of the screen.

To remove this programme position number, press the **i** (Information) button again.

System Update menu (DVB mode only)

The System Update menu allows the DVB system to check that it has the latest software. If newer software is available, it can be downloaded.

During **DVB mode**

Press the **MENU** button.

Move to choose **Setup menu**.

Access **Setup menu**.

Move to choose **DVB System Setup**.

Access **DVB System Setup**.

Move to choose **System Update**.

Access **System Update**.

The System Update menu will appear.

MENU

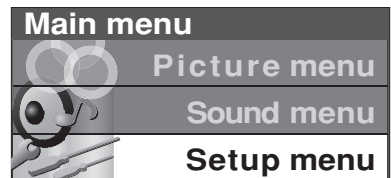
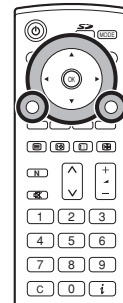

Setup menu	
DVB Timer programming	Off
DVB Tuner lock	Off
DVB Auto Setup	Off
DVB System Setup	Access
New Service Message	Off
Shipping condition	Off
Q-Link	AV2
AV2 out	Monitor
Off timer	Off
Child lock	Off
Power on preference	TV

DVB System Setup	
Signal Quality	Off
Common Interface Module	Off
Favourites Setup	Off
Preferred Subtitles	English
System Update	Access
Display Timeout	3 seconds
Screensaver Active	After 2 minutes
Settings	Default

New version found!
Do you really want to update the software and reboot the system?

System Update
Searching for new version: Ready!
Current version E10_0.11 is up to date.

The DVB system will now begin to search for new software - this will take a few seconds.

If a newer version is available:

Important Note!

You must **not** switch off the TV while downloading is in progress, as errors could occur.

Downloading will take a few minutes to complete, so check first that there are no imminent programmes that you wish to watch.

Press the **OK** button to initiate download.



If a newer version is not available:

A message will appear telling you that the current software is up-to-date.

Press the **EXIT** button at any time to go back to watching TV.



System Update notification

Occasionally, a newer version of software may become available. An automatic update message may be shown when you switch on your TV.

Note:

The "New service message" option must be set to On, in the Setup menu, for this message to appear.

The message will only appear when you are watching any of the BBC channels.

Press the **OK** button to initiate download.



Press the **EXIT** button to ignore this message.



Important Note!

You must **not** switch off the TV while downloading is in progress, as errors could occur.

Downloading will take a few minutes to complete, so check first that there are no imminent programmes that you wish to watch.

DVB Timer programming menu

For an external recording device to record DVB programmes, the integrated DVB system must be active to provide the signal. The Timer programming menu allows you to choose programmes that you wish to record. At the correct time, the DVB system will switch on and tune to the correct station (even if the TV is in standby mode). If the recording device is compatible with Q-Link or similar technologies (see page 29) and connected to the TV's AV2 / AV4 terminal, you do not need to program the device – the DVB system will control the recording process.

The device must be connected to the TV's AV2 / AV4 terminal using a SCART cable to record DVB programmes.

During DVB mode

Press the **MENU** button.

MENU

Move to choose **Setup menu**.

Access **Setup menu**.

Move to choose **DVB Timer programming**.

Access **DVB Timer programming**.

Press the **OK** button to begin programming.

Select the Programme position to be recorded.

Move to the Date field.

Set the Date on which recording is to take place.

The current Date and Time are shown at the top of the menu. See page 27 for further Date options.

Move to the Start time field (◀○▶) and set the Start time (○▶).

Move to the End time field (◀○▶) and set the End time (○▶).

The duration of the recording is shown in the Min. column.

The channel position, start and end times can also be input using the numeric keys on the remote control.

Move to the Subtitles field.

If you wish to record subtitles (if available) select Auto.

Press the **OK** button to store.

Press the **EXIT** button to leave the DVB Timer Programming screen.

Notes:

- To delete a timer programme, select the recording with the cursor bar and press the **Red** button.
- To edit a previously entered timer programme, select it with the cursor bar and press the **OK** button.
- Timer programmes can also be entered from the TV Guide. See page 28.

Two minutes before the recording is due to start, a reminder will appear on screen:

Press the **OK** button to remove the reminder from the screen.

If you wish to cancel the recording, press the **EXIT** button.

Note:

The above 2 operations will not be necessary if the TV set is in standby mode.

Notes:

Thirty seconds before the recording is due to start the DVB system will tune to the correct station. If you were already watching another DVB station you will see the station change on screen. If you were watching an analogue channel, you will not see the change. You can continue to watch analogue stations while a timer recording is in progress.

If you attempt to switch to another DVB programme position while a timer recording is in progress the message "DVB prog. is locked for recording" will be displayed. Press the **OK** button to continue recording, or **EXIT** to unlock the programme position. Beware that if you press **EXIT**, timer programming for this DVB position will be immediately deleted.

To immediately cancel a recording that is already in progress, press **GUIDE** then **EXIT**.

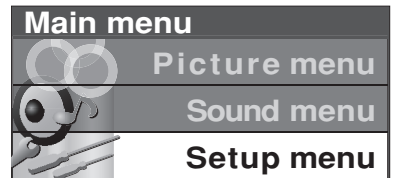

Setup menu	
DVB Timer programming	Access
DVB Tuner lock	Off
DVB Auto Setup	
DVB System Setup	
New Service Message	Off
Shipping condition	
Q-Link	AV2
AV2 out	Monitor
Off timer	Off
Child lock	Off
Power on preference	TV

DVB Timer Programming					Date	Time
Pos.	Name	Date	Start	End	min.	
---	---	---	---	---	---	---
---	---	---	---	---	---	---
---	---	---	---	---	---	---
---	---	---	---	---	---	---
---	---	---	---	---	---	---
---	---	---	---	---	---	---
---	---	---	---	---	---	---
---	---	---	---	---	---	---
---	---	---	---	---	---	---
Delete						

DVB Timer Programming					Date	Time
Pos.	Name	Date	Start	End	min.	
1	BBC ONE	20/02	12:00	12:30	30	Off
---	---	---	---	---	---	---
---	---	---	---	---	---	---
---	---	---	---	---	---	---
---	---	---	---	---	---	---
---	---	---	---	---	---	---
---	---	---	---	---	---	---
---	---	---	---	---	---	---
---	---	---	---	---	---	---
---	---	---	---	---	---	---
Delete						

DVB Timer programming menu

Daily and Weekly Timer Programmes

While in the Date field of the DVB Timer programming menu, you can select various options to determine how often a recording should be made. Press the down cursor button repeatedly to access the following options:



Daily Su–Sa

The recording device will record at the same time every day.

Daily Mo–Sa

The recording device will record at the same time each day from Monday to Saturday.

Daily Mo–Fr

The recording device will record at the same time each day from Monday to Friday.

Weekly Sa, Fr, Th, We, Tu, Mo or Su

The recording device will record at the same time on the same day each week.

DVB Timer Programming					Date	20:02:03
Pos.	Name	Date	Start	End	min.	
1	BBC ONE	Wed Th	12:00	12:30	30	Off
---	---	---	---	---	---	---
---	---	---	---	---	---	---
---	---	---	---	---	---	---
---	---	---	---	---	---	---
---	---	---	---	---	---	---
---	---	---	---	---	---	---
---	---	---	---	---	---	---
---	---	---	---	---	---	---

Notes:

- If new timer programme data overlaps any part of an existing timer programme, the message “Timer Incorrect” will be displayed and the new data will be cleared. If overlapping data is entered using the Timer function on the TV Guide menu (see page 28), the message “Timer overlap with other timer!” will appear.
- The TV set must be “On” or in “Standby” mode for the DVB programme signals to be output to the external recording device.

Encrypted Programmes

In the future, some DVB programmes may be “encrypted”. This means that the DVB programme cannot be viewed or recorded unless you have the correct Common Interface module to decode the programme.

When you attempt to view or set Timer recording of an encrypted programme and you have no CI module inserted, a message will appear on screen.

TV Guide

The DVB TV Guide displays the current programmes being transmitted, and forthcoming programmes on each DVB channel, up to seven days ahead (If broadcasters transmit the programmes information).

Press the **GUIDE** button.

Three separate guides can be accessed by pressing the **GUIDE** button repeatedly. Choose from 'Category', 'Favourites list' and 'Type'.

The Favourites list can be customised using the **DVB System Setup** menu (see page 23).

After a few moments the DVB TV Guide will be displayed. If you wish to view one of the listed DVB stations, select it with the up or down cursor buttons and press the **OK** button.

From the 'Category' and 'Type' guides, you can also view a list of DVB channels by category, for example 'Free TV' or 'Radio' services, 'News' or 'entertainment' by pressing the left or right cursor buttons. The categories displayed will change, depending on which of the guides you have selected.

GUIDE

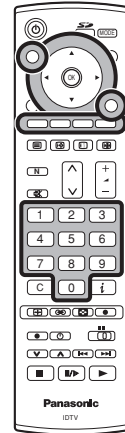

Info and Time Prog.

You can view further information about the selected programme:

Select a DVB channel using the up or down cursor buttons. Press the **Green** button to move the highlighted cursor bar to the EPG (Electronic Programme Guide).



The EPG lists current and forthcoming programmes up to seven days in advance (if being broadcast). The days of the week are represented by numbers, displayed above them. Use the numeric keys on your remote control to move the EPG listing through the next seven days.

Press the **Green** button to move the highlighted cursor bar back to the EPG (Electronic Programme Guide).

Select the programme for which you require further information using the up or down cursor buttons.

Press the **Yellow** button to display the information.

Press the **Yellow** button again to return to the list of programmes.



When you select a programme from the EPG list which has yet to start, press the **Blue** button to send details of the selected programme to the timer programme menu, ready for automatic recording at the correct time.



Press the **Red** button to move the highlighted cursor bar back to the list of DVB channels.



Press the **EXIT** button to exit the Guide.



DVB TV Guide

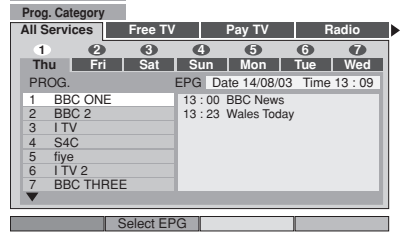

DVB TV Guide

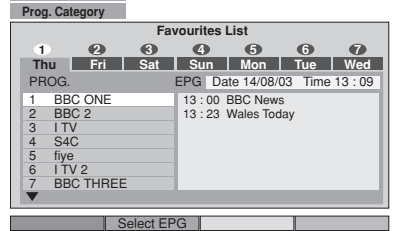

DVB TV Guide

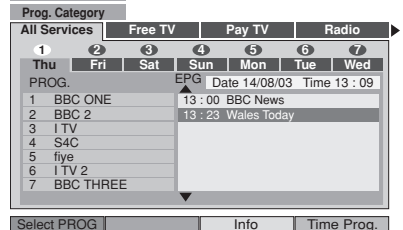

DVB TV Guide

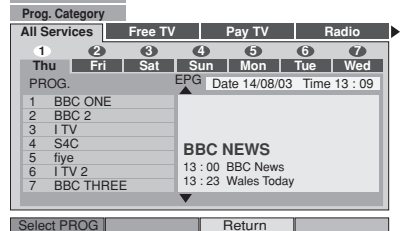

Q-Link

Q-Link allows the television to communicate with a compatible VCR or DVD Recorder.

For Q-Link communication to work, the TV must be connected to a recording device with the “Q-Link”, “NEXTVIEWLINK”, “DATA LOGIC”, “Easy Link”, “Megalogic” or “SMARTLINK” logo using a “fully wired” Scart cable between the AV2 / AV4 terminal of the television and the appropriate terminal on your VCR or DVD Recorder.

For connection to the appropriate Scart terminal on the recording device, refer to the device’s instruction book.

When using a “NEXTVIEWLINK” device the main features possible are the following :

Preset Download

This allows the programme order from the TV to be downloaded to the recording device, helping to ensure that correct recordings are made; there are several ways to perform this operation :

1. During installation as explained in the “Quick Start Guide” on page 6-8.
2. When Auto setup is started from within the Tuning menu. See page 14.
3. Preset download started from the recording device, refer to the device’s instruction book.

Because a recording device cannot tune to DVB stations, only the analogue programme positions are downloaded to the device.

What You See Is What You Record (DIRECT TV RECORDING)

This will allow the immediate recording of the programme currently shown on the TV, by the recording device attached to the Scart terminal, which can be chosen using “Q-Link”. See page 13.

Press the **DIRECT TV REC** button.



If the recording device is in Standby mode with usable recording media inserted, it will automatically switch on when you press the **DIRECT TV REC** button.

If a “Q-Link” device is connected, a message will appear on the TV screen showing what is being recorded, or if it is not possible to record. Some “Q-Link” compatible devices will only display the message when on the VCR programme position(0) or in AV mode. Refer to the device’s instruction book.

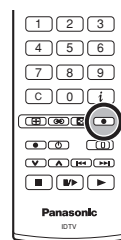

Recording in progress

The recording device is recording the programme signal from its own tuner. If you wish you can switch off the TV and leave the device recording in the normal way.

Recording DVB stations

If you press the **DIRECT TV REC** button while watching a DVB station, the recording device will automatically switch to its AV input to record the DVB signal from the TV (via the SCART cable), and the DVB programme position will be locked. If you attempt to select another DVB programme position while recording, you will see the message “DVB programme is locked”. Press the **OK** button to clear the message, or the **EXIT** button to unlock the programme. Beware that if you press **EXIT**, the DVB programme will be unlocked – switching to another DVB programme will spoil your intended recording. Stop the recording manually.

Additionally, when using a “Q-Link” device the main features possible are the following :

The following features are only available from the device connected to the Scart terminal selected using “Q-Link”. See page 13.

TV / Recording device Auto Power On

If you insert pre-recorded media into the recording device and press the Play button whilst the TV is in Standby mode, the TV will automatically switch on and select the correct AV input so that you can view the content.

Recording device Auto Power Standby

When the TV is switched into Standby mode, the recording device will also switch into Standby mode if there is no media inserted, or if there is media inserted and the device is in Rewind or Stop mode. If a VCR is rewinding a tape, it will not switch into Standby mode until rewinding has finished.

Recording device Image View On

If the TV is in Standby mode and the recording device sends a menu to be displayed on the TV screen (e.g., Main menu), the TV will automatically switch On and the menu will be displayed.

This TV will also communicate with other recording device’s that bear the following logos :

- “DATA LOGIC” (a trademark of Metz Corporation)
- “Megalogic” (a trademark of Grundig Corporation)
- “Easy Link” (a trademark of Philips Corporation)
- “SMARTLINK” (a trademark of Sony Corporation)

Important Note:

Some recording devices may not support all or some of the above functions. Refer to the instruction book for the device. If Q-Link functions do not work, check the connection and ensure that the scart lead is a fully-wired type.

No recording -Check tape or disc

The tape or disc may have been “write protected”, missing or may be damaged. The device may already be recording. Refer to the device’s instruction book.

Aspect Controls

The Widescreen TV will allow you to enjoy viewing the picture at its optimum size and aspect, including widescreen cinema format pictures.

Press the **ASPECT** button repeatedly to move through the seven aspect options:

Panasonic Auto, 16:9, 14:9, 4:3, Zoom1, Zoom2 and Zoom3
Photo View mode: Panasonic Auto, 16:9, 14:9, 4:3 and Just

OR

Press the **ASPECT** button. Whilst the on screen selector keys are displayed, use the **Red** or **Green** buttons to move in either direction through the seven aspect options (except Photo View mode).

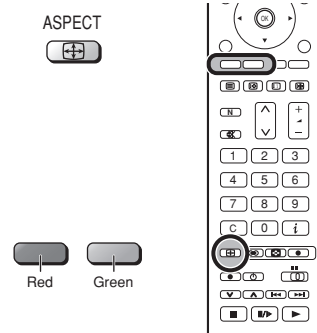

Panasonic Auto

Panasonic Auto determines the best aspect ratio to use to fill your screen. It does this using a four step process to determine if the picture being viewed is a widescreen picture.

If **Panasonic Auto** detects a widescreen signal it switches into the appropriate widescreen mode. If **Panasonic Auto** does not detect a widescreen signal then this advanced TV set enhances the picture for optimum viewing pleasure.

The text shown on the screen indicates how **Panasonic Auto** determined which ratio to use:

Panasonic Auto switches to the appropriate widescreen ratio. "Panasonic Auto" appears in the top left of the screen if black stripes above and below the picture are detected.

Panasonic Auto chooses the best ratio and expands the picture to fill the screen. This process can take several minutes, depending on the darkness of the picture.

You may prefer to manually select one of the other aspect options available to view the picture.

Notes:

- If, in Panasonic Auto mode, you experience problems with the screen display size when playing back widescreen format recordings from your VCR then it is possible that the tracking control of your VCR requires adjustment (your VCR instruction book will contain adjustment details).
- The widescreen aspect ratios of different films and programmes can vary. If these are wider than a standard 16:9 aspect picture then a black band may be visible at the top and bottom of the screen.
- "WIDE" will appear in the top left corner of the screen and picture aspect changes accordingly in any aspect modes, if a widescreen identification signal (WSS) is detected or a control signal is found through a Scart terminal.



"WIDE" appears in the top left of the screen, **Panasonic Auto** switches to the appropriate 16:9 or 14:9 widescreen ratio.



"Panasonic Auto" appears in the top left of the screen. The best ratio is chosen and the picture expanded to fill the screen.

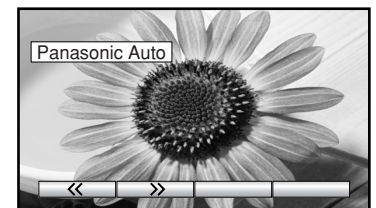

Press the **ASPECT** button, then use the **Red** or **Green** buttons to move in either direction through the seven aspect options.

Aspect Controls

16 : 9

16:9 will display a true 16:9 (anamorphic) picture with no aspect distortions.

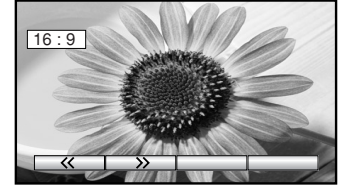

16 : 9

14 : 9

14:9 will display a 14:9 picture at its standard 14:9 size without any stretching.



14 : 9

4 : 3

4:3 will display a 4:3 picture at its standard 4:3 size with no aspect distortions.

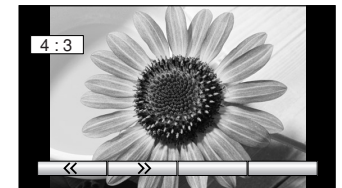

4 : 3

Just (Photo View mode only)

Use **Just** when you wish to expand a 4:3 picture to fill the whole screen. The 4:3 picture will be stretched horizontally so that the image fills the screen, this is done in such a way that the stretching is only obvious at the left and right edges of the screen.



Just

Zoom1

Zoom1 will display 16:9 letterbox or 4:3 pictures with no aspect distortions.

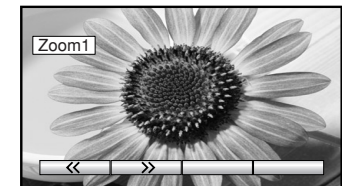

Zoom1

Zoom2

Zoom2 will display 16:9 anamorphic letterbox pictures as a full screen display with no aspect distortions.

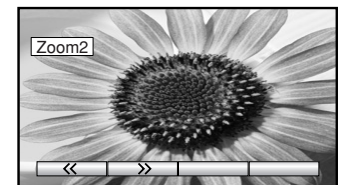

Zoom2

Zoom3

Zoom3 will display 21:9 letterbox pictures as a full screen display with no aspect distortions.

16:9 will display the picture at its maximum size but with slight stretching.

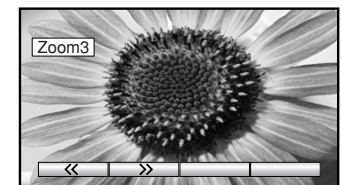

Zoom3

Multi window

You can watch two different pictures at the same time, e.g. one from a TV channel and the other from an AV input.

Press the **MULTI WINDOW** button. Whilst the on screen selector keys are displayed, use the **Red** or **Green** buttons to move between the **picture in picture** feature, **picture out of picture** and **picture and picture** feature.

The on screen selector keys that appear for the features clear after a few seconds. If you want to select an operation when the keys are not shown, press the **MULTI WINDOW** button again and the keys will reappear.

Press the **MULTI WINDOW** button (whilst the selector keys are displayed) to return to normal viewing.

Note:

This TV has one tuner, when the main and sub windows are both TV mode, the 2 pictures will be the same.

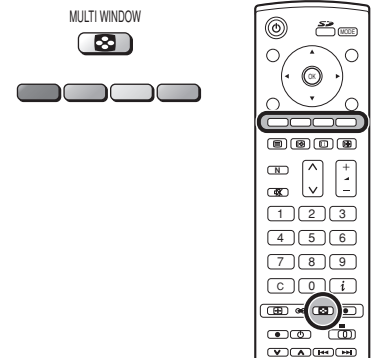

Picture in picture

Allows two pictures to be viewed at the same time.

Press the **Yellow** button to select the contents of the smaller window, switching between displaying a TV channel and all AV sources in turn.

To change the TV channel: press the **Yellow** button until the currently selected TV channel is shown, then use the remote control to change channel (whilst the on screen selector keys are still displayed).

Press the **Blue** button to swap the contents of the two windows.

Use the remote control to select a TV channel or an AV source to appear in the main window.

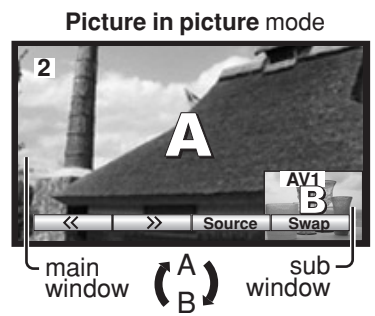

Picture in picture mode

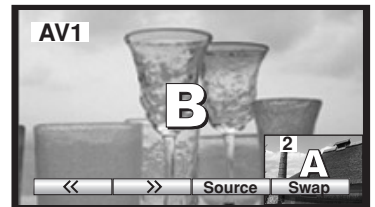

The two pictures have been swapped, the picture in the smaller window has become the main window picture.

Picture out of picture

Allows two pictures to be viewed at the same time. The difference is how the two pictures are displayed: in picture in picture the smaller window appears within the main picture; in picture out of picture the smaller window appears to the right of the main picture.

Press the **Yellow** button to select the contents of the smaller window, switching between displaying a TV channel and all AV sources in turn.

To change the TV channel: press the **Yellow** button until the currently selected TV channel is shown, then use the remote control to change channel (whilst the on screen selector keys are still displayed).

Press the **Blue** button to swap the contents of the two windows.

Use the remote control to select a TV channel or an AV source to appear in the main window.



Picture out of picture mode

Picture and picture

Allows two pictures to be viewed at the same time.

Press the **Yellow** button to select the contents of the right window, switching between displaying a TV channel and all AV sources in turn.

To change the TV channel: press the **Yellow** button until the currently selected TV channel is shown, then use the remote control to change channel (whilst the on screen selector keys are still displayed).

Press the **Blue** button to swap the contents of the two windows.

Use the remote control to select a TV channel or an AV source to appear in the left window.

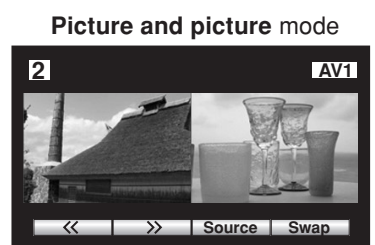

Picture and picture mode

Picture and text (Analogue mode only)

Press the **TV/TEXT** button, followed by the **MULTI WINDOW** button to move between viewing teletext and the picture and text feature. Picture and text lets you see the current programme and a page of teletext side by side.

Whilst using this feature, the remote control affects the teletext page; if you wish to make changes to the programme viewed press the **TV/TEXT** button to return to watching the programme on its own then make the desired changes.

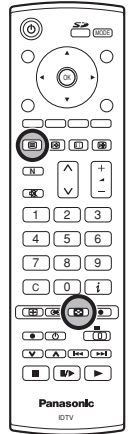

Teletext mode

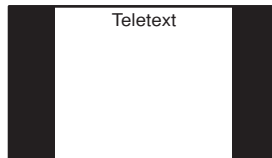

Picture and text mode

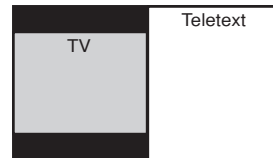

Photo View mode

Still image data (JPEG) made with a digital camera or digital video camera can be played back using an SD Card / PC Card.

Displayable Image Formats: Baseline JPEG 64 × 64 – 8192 × 8192 pixels (sub-sampling 4:2:2 or 4:2:0)

Displayable number of folders: Max 100

Notes:

- Some parts of an image may not be displayed or the image may be displayed on a smaller scale depending on the size of the image.
- Only EXIF standard JPEG images can be displayed on this TV.
- Photo view cannot support over 3000 JPEG files.
- Cards must be formatted with FAT12 or FAT16 in order to be viewed on this TV.
- Photo view is not compatible with card type hard disk (Micro Drive, Mobile type hard disk).
- Some PC Cards may not be usable.
- Without operations for 5 minutes, Screensaver will start automatically to prevent image retention (except Slide show). To exit, press any button.

Card Data Protection

- Do not remove the card whilst it is being accessed.
- Do not touch the terminals on the back of the SD Card / PC Card.
- Electrical interference, electrostatic discharges and malfunctions of the TV set or card may all result in damage to the card or data loss. It is recommended that any important data also be backed up on a PC.
- Stored data should be periodically backed up as a protection against data corruption, data loss or device malfunction. Please note that our company shall not accept any liability for damage or loss of stored data.
- Before inserting or removing the PC Card, make sure that the TV is turned off. Otherwise, it may damage the unit. Do not insert anything other than the PC Card.

Cautions:

- Always insert card in the correct direction. Failure to do so may result in damage to the card and this set.
- The SD Card and PC Card are precision devices. Do not subject them to excessive pressure or strong impacts.

Warning:

As with any small object, SD Cards can be swallowed by young children. Do not allow children to handle the SD Card. Please remove the SD Card immediately after use.

Folders and Files

Digital cameras that are compliant with DCF specifications use folders with a specific structure. The following diagram shows an example of the folder structure.

Example:

If the Card file hierarchy is displayed on the PC as shown below.

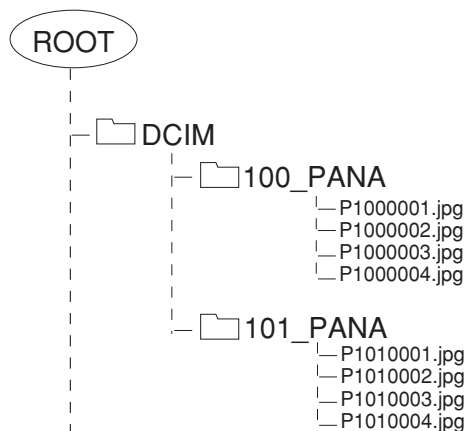

DCIM Folder

The digital camera creates this folder automatically.

100_PANA Folder

Folder names consist of a 3-digit folder number which is followed by five arbitrary characters. Digital camera images are stored within these folders.

JPEG files in the 100_PANA folder are displayed when a Card, which is structured as shown left, is inserted.

Notes:

- The folder name may vary according to the digital camera being used.
- When a directory or file is created, only the characters “A-Z”, “a-z”, “0-9” and “_” are used. Two-byte characters or other special codes shall not be used.

P1000001.JPG: DCF File

File names consist of four arbitrary characters followed by a 4-digit file number. DCF files are image files (normally JPEG files) that have been taken by a digital camera.

Photo View mode

SD Card

Insertion

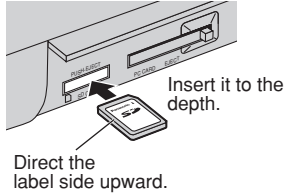

Removal

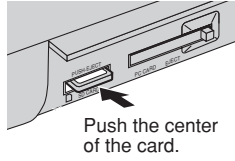

PC Card

Before inserting or removing the PC Card, make sure that the TV is turned off. Otherwise, it may damage the unit. Do not insert anything other than the PC Card.

Insertion

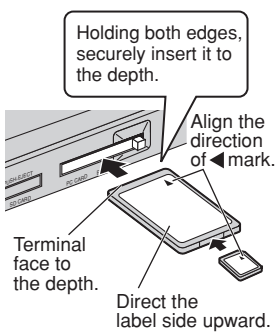

Removal

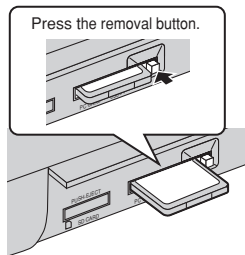

If PC Card cannot be removed
Push in PC Card again, and press the removal button.

Caution

If PC Card adapter is used, remove it together with the adapter.

Compatible Card

SD Card slot	PC Card slot
SD Card	Compact Flash*
Multi Media Card	Smart Media*
miniSD Card	Memory Stick*
	xD Picture Card*
	Flash ATA Card*

- miniSD Card requires miniSD™ adapter.
- The media* listed in the right column above can be read via the PC Card in the PC Card adapter.
- Hard disk PC Cards and other recorded media cannot be used.
- Place the selected media onto the PC Card and then insert into the PC Card Slot.
- When both SD Card and PC Card are inserted, the SD Card contents have priority and will be displayed.
- If the Card is incompatible, "This type of card is not supported" is displayed on screen. Remove the Card only when Access indication is not displayed.
- If the file is not formatted with FAT12 or FAT16, "This type of format is not supported" is displayed.
- If the JPEG file is corrupted and cannot be decoded, "This type of image is not supported" is displayed.

Notes:

- Insert / remove the SD Card while Card Menu Screen or "Card is not inserted correctly" is displayed.
- Be sure Access indication is not displayed before Card insertion / removal.
- Before reinserting the SD Card after removing it, wait until "Card is not inserted correctly" is displayed. If there are Cards in both Card Slots, wait until the Card Menu Screen of the other Slot is displayed and Access indication is no longer displayed before reinserting the Card.
- If the JPEG is modified using a PC, it will not be displayed on the TV.
- It may take long time to display the thumbnail if there are lots of files or if the file size is big.

File Allocation Table (FAT)

A table that contains the status of various segments of disk space used for file storage. Also, the file system that maintains the table.

Press the **SD** button.



The screen below is displayed automatically when a card is inserted. If "Card is not inserted correctly" appears, confirm that a card is correctly inserted.

Press the **SD** button again to exit Photo View mode.

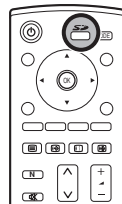

Card Menu Screen

Selected File

Selected File number / Total number of Files

Index Area
12 files are displayed here.

File Data
The information of the selected file (framed in yellow) is displayed.

SD Card Indication
This indication is displayed whilst SD Card is inserted.

PC Card Indication
This indication is displayed whilst PC Card is inserted.

Access Indication
Access is displayed whilst data is read.

PHOTO VIEW MODE

0001 / 0013

Filename : 102-0001
Date : 30 / 03 / 2002
Pixel : 1600X1200

Access

Photo View mode

Picture menu

During **Photo View mode**

Press the **MENU** button.

MENU



Move to choose **Picture menu**.



Access **Picture menu**.



Move to choose menu option.



Adjust chosen option or access chosen menu.



Press the **EXIT** button at any time to exit Picture menu.

EXIT



Backlight, Contrast, Brightness, Colour, Sharpness

Increase or decrease the levels of these options according to your personal preference.

Tint The picture hue can be adjusted to suit your taste.

Colour balance Allows you to set the overall colour tone of the picture. Choose from **Cool, Normal** and **Warm**.

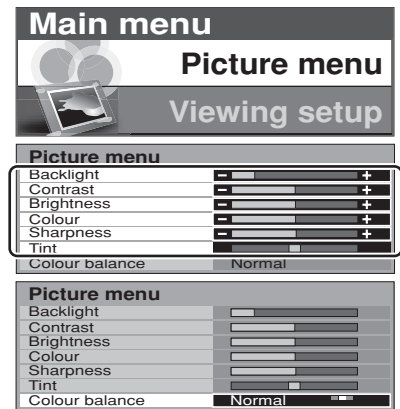

Viewing setup

During **Photo View mode**

Press the **MENU** button.

MENU



Move to choose **Viewing setup**.



Access **Viewing setup**.



Move to choose menu option.



Adjust chosen option or access chosen menu.



Press the **EXIT** button at any time to exit Viewing setup.

EXIT



Slide show Provides access to Slide Show mode. See page 37.

Interval Allows you to select the display intervals between 5 to 90 seconds.

Sequence Allows you to select the **Order** or **Random**.

Repeat When Repeat is **On**, the Slide Show repeats automatically.

Card Select either **SD** or **PC** when both cards are inserted in the slots.

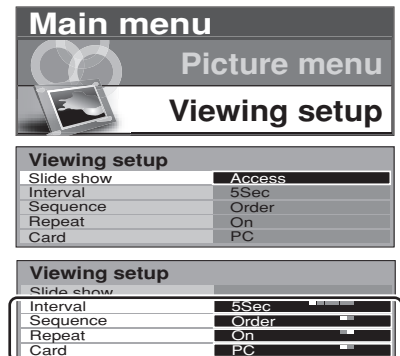

Photo View mode

When you press the **SD** button, thumbnail screen is displayed automatically.
After that you can choose your desirable view mode between the following three modes.

Multi mode

12 images are displayed.

Press to select desired image.



Press the **OK** button to display Single mode.



Single mode

A single image selected from the index area fills the screen.
You can also rotate or magnify the image.

Press to select the next or previous image.



Press the **OK** button to display Multi mode.



Press the **Red** or **Green** button to rotate the image.
Each press rotates images 90 °.

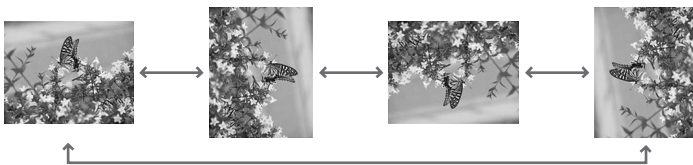
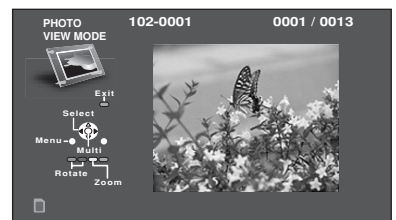
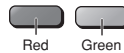

Press the **Yellow** button to magnify the image.
To restore press the **Blue** button.



Slide Show

Images are displayed one after another as a slide show.

To start Slide Show access **Viewing setup**.
After setting Interval, Sequence and Repeat, access **Slide show**.
When both SD Card and PC Card are inserted, move to choose Card and select SD or PC before accessing Slide show.
See page 36.



Press the **OK** button at any time to return to the Single mode.



Viewing setup	
Slide show	
Interval	5Sec
Sequence	Order
Repeat	On
Card	PC

Viewing setup	
Slide show	Access
Interval	5Sec
Sequence	Order
Repeat	On
Card	PC









Note:

When you are in the Slide Show mode, you can change the Aspect of the image on screen by pressing the **ASPECT** button on the remote control.

VCR / DVD operation



The Remote Control is capable of operating some functions of selected Panasonic VCRs and DVD (Digital Versatile Disc) equipment. Some VCR and DVD equipment have different functions, so to ensure compatibility please refer to the equipment's instruction book or consult your dealer for details.



	<p>Standby Press to switch the VCR, DVD or DVD recorder to Standby mode. Press again to switch back on.</p>
	<p>VCR / DVD switch Use this switch to select whether controls operate the DVD equipment or VCR.</p>
	<p>Play Press to playback the tape or DVD.</p>
	<p>Stop Press to stop the tape or DVD.</p>
	<p>Skip / Fast Forward / Cue VCR: Press to fast forward the tape. In Play mode, press to view the picture rapidly forward (Cue). DVD: Press once to skip to the next track or title.</p>
	<p>Skip / Rewind / Review VCR: Press to rewind the tape. In Play mode, press to view the picture rapidly in reverse (Review). DVD: Press once to skip to the previous track or title.</p>
	<p>Pause / Still Press in Play mode, the picture will pause. Press again to restart play.</p>
	<p>Programme Up / Down Press to increase or decrease the programme position by one.</p>
	<p>Record Press this button to start recording.</p>

Teletext operation

In Analogue mode

- Teletext features may vary depending on the Broadcasting Companies and is only available if the channel selected is transmitting Teletext.
- Pressing the **MENU** button whilst in Teletext operation will display the backlight function with a white bar and the contrast function with a cyan bar, press  to alter the setting as required.
- Pressing the **MENU** button whilst in Teletext operation will display special function options at the bottom of the screen.
- Pressing the **Volume up / down** button whilst in Teletext operation will display the volume function with a green bar, press  to alter the setting as required.

What is List mode ?

In List mode, four differently coloured page numbers are situated at the bottom of the screen. Each of these numbers can be altered and stored in the TV's memory.

What is FASTEXT mode?

In FASTEXT mode, four differently coloured subjects are situated at the bottom of the display. To access more information about one of these subjects, press the appropriately coloured button. This facility enables fast access to information on the subjects shown.

Note:

If Teletext is in use, the aspect ratio is set to 16:9.



TV / Teletext mode

Press the **TV/TEXT** button to switch between the current programme.



Page Selection

Pages can be selected in two ways :

- a. Press the Up / Down buttons to increase or decrease the page number by one.
- b. By entering the page number, using 0 - 9 on the remote control.



Full / Top / Bottom

Press the **MENU** button to display special functions, followed by the **Green** button. Press the **Green** button again to expand the **BOTTOM** half. Press again to return to normal (FULL) size.



Reveal

Press the **MENU** button to display special functions, followed by the **Red** button to reveal hidden words e.g. quiz page answers. Press again to hide.



Red / Green / Yellow / Blue buttons

In FASTEXT mode they correspond to the differently coloured subjects.
In List mode they correspond to the differently coloured page numbers.



List Store

In List mode the four page numbers can be altered (programme positions 1 - 25 only). To do this, press one of the four coloured buttons and enter the new page number. Press and hold the **OK** button, the page numbers will change to white indicating that the page is stored.



HOLD

To hold the Teletext page when viewing multi-page information. Press again to return to automatic page update.

Teletext operation

It is not possible to change the programme position when in News flash, Update or Sub Coded Page Access operation.

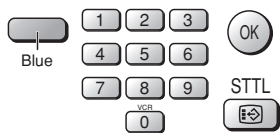

Favourite Page (F.P.)

Stores a favourite page in memory for instant recall. To store such a page, the TV must be in List mode, and the programme position must be from 1 - 25.

Press the **Blue** button, select the page number, then press and hold the **OK** button. The page number is now stored.

Press **STTL** to recall this page.



Update Display

Press the **MENU** button to display special functions, followed by the **Yellow** button to view the TV picture whilst searching for a Teletext page (this is not necessary in **picture and text** mode, as the picture is displayed on the left of the screen). When found, the screen will display the page number at the top left. Press the **Yellow** button to view the page.

Press the **TV/TEXT** button again to return to normal TV operation.

News Flash

When a news flash page has been selected, press the **MENU, Yellow** buttons, to view the TV picture. When an update is received, the page number will be displayed on screen.

Press the **Yellow** button to display the News Flash.

Press the **TV/TEXT** button to return to normal TV operation.

Update

Press the **MENU, Yellow** buttons to see the update of information on certain pages.

When an update is received, the page number will be displayed at the top left of the screen.

Press the **Yellow** button to view the page.

Press the **TV/TEXT** button to return to normal TV operation.



Accessing sub pages

When Teletext information exceeds one page, it may take some time for the automatic changing of the sub pages to reach the sub page you require. As each sub page is found its number is displayed at the top of the page so that you may select it; as more sub pages are picked up, the display at the top of the page changes, so that you are always offered the most recently transmitted selection of sub pages.

In Teletext operation, use the following procedure to access sub pages:

If the sub page you want to look at is not yet available, press the **MENU** button (to display special functions) followed by the **Yellow** button to view the TV picture whilst waiting for more sub pages to be found. The sub pages found will be displayed across the top of the screen.

When the sub page you are waiting for is available press the **Yellow** button to return to viewing the Teletext pages, then use the left and right cursor buttons to select the sub page of your choice.

The maximum number for sub page that can be entered is restricted to 79 by broadcasters.

Notes:

- If you do not want to display the on screen selector keys on the TV picture whilst waiting for a sub page to be found, press the **MENU** button to clear the keys from the screen. Press again to redisplay the keys.
- If you have cleared the special function keys from the screen and then used the left and right cursor buttons to select a sub page, whilst still viewing the TV picture, you must press the **MENU** button then the **Yellow** button to display the Teletext page again.
- If the top of the page indicates that sub pages are being transmitted but the page displayed never changes, then the 'sub page number' is there to show the page contents have been updated, there are no sub pages.

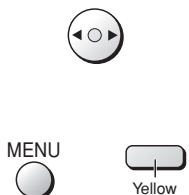

Teletext operation



Alternatively, if you know which sub page you require, press the **MENU** button (to display special functions) followed by the **Blue** button; T**** will be displayed where the page number is normally found.

Enter desired sub page number before the T**** disappears.

e.g., to select page 6 enter 0, 0, 0 and 6.

Press the **Yellow** button to view the TV picture whilst waiting for more sub pages to be found. The sub pages found will be displayed across the top of the screen.

When the page is available, press the **Yellow** button to view the page. Regardless of how many pages are found, pressing the **Yellow** button will take you to the sub page which you requested.

Press the **TV/TEXT** button to return to normal TV operation.

INDEX



When in FASTEXT operation

Press the **INDEX** button to return to the main index page.

Depending on the way information is transmitted, this may have to be pressed more than once to return to the main index page.

In DVB mode



DVB teletext services

DVB teletext services differ greatly from analogue teletext. When you switch to a DVB teletext service, the images you see can contain graphics and text, laid out and controlled in a manner decided by the broadcaster. In all cases, it is possible to navigate the pages using buttons on the remote control, but because the commands available must apply to all manufacturers of DVB equipment, some on screen commands may not correspond exactly to the remote control buttons.

For example:

- For the on screen command 'select' or 'go', use the **OK** button.
- If you see the ◀▶▼▲ symbols, use the appropriate **CURSOR** keys.
- If you see a line of key words displayed in red, green, yellow and blue, use the coloured multifunction buttons to operate the functions.
- For numbered options, use the numeric keypad.
- The **TV/TEXT** button should allow you to exit the teletext system. Alternatively, press the **Channel up / down** buttons to select another channel.

As soon as you switch to a DVB channel with links to a teletext service, software is downloaded in the background to enable the teletext function. This means that when switching to a DVB channel, you should wait for approximately 5 seconds before pressing the **TV/TEXT** button – this will allow the software to download. If you press the **TV/TEXT** button before download is complete, there will be a short delay before the text screen is displayed.

While navigating DVB teletext, you will find there is a short delay when moving between pages while the page downloads.

There is often a prompt shown somewhere on the page (for example "Loading") to let you know what is happening.

Audio / video connections

It is possible to connect a variety of additional equipment to this TV. The following pages detail how to connect external equipment to the front and rear of the TV.

Once your equipment is connected, use the following procedure to view the input:

Press the **TV/AV** button.

Whilst the on screen selector keys are displayed, press coloured buttons to select the AV source you wish to view.

Red button : AV1 Scart terminal

Green button : AV2 Scart terminal

Yellow button : AV3 Audio, Video, S-Video terminals

Blue button : AV4 Scart, Component terminals

The on screen selector keys that appear clear after a few seconds.

If you want to select an input when the keys are not shown, press the **TV/AV** button again and the keys will reappear.

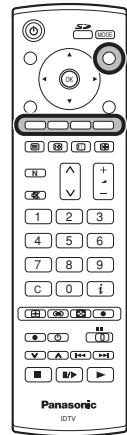
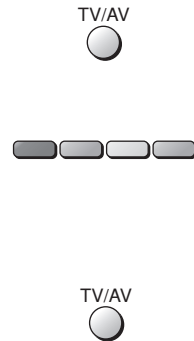

Notes:

- You can also select an AV source using the **TV/AV** button on the front panel of the TV.
Press the **TV/AV** button repeatedly until you reach the AV source you wish to view.
- When in **AV mode** a reduced number of options are available in the **Sound** and **Setup** menus (e.g., in the Setup menu there is no **Analogue Tuning Menu** option).

How to connect the Headphones / AV3 terminals

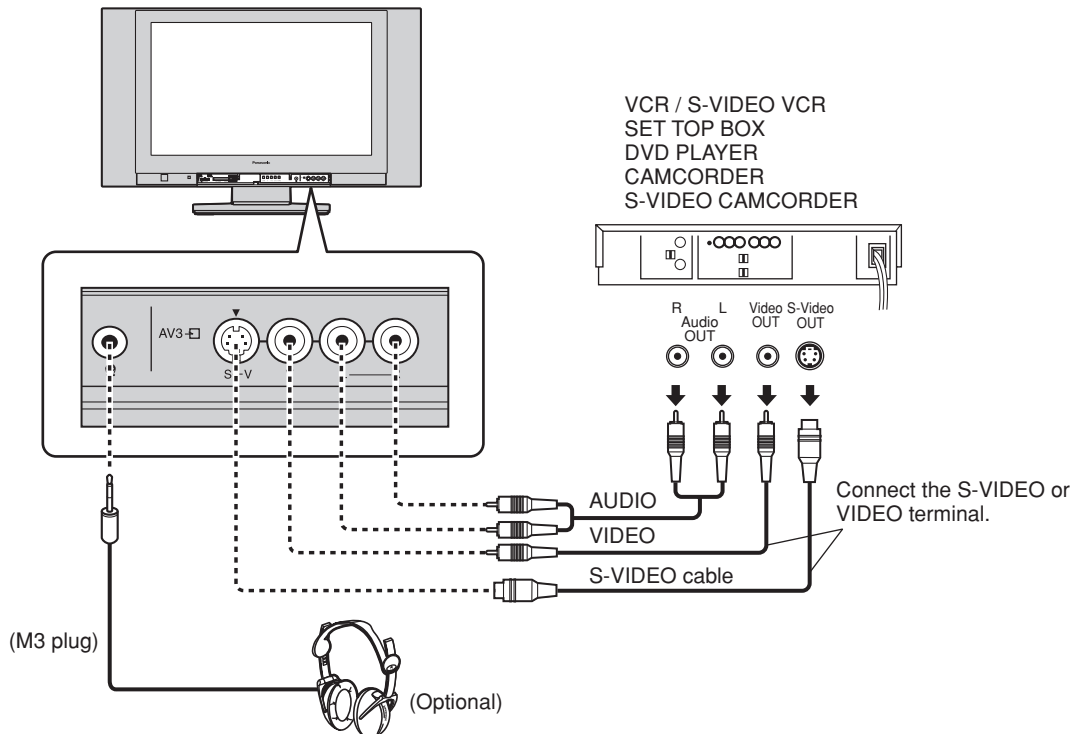

Notes:

- The volume level of the headphones can be adjusted by selecting "Headphone volume" from the Sound menu.
- Additional equipment and cables shown are not supplied with this TV set.

Audio / video connections

How to connect the Audio Output terminals

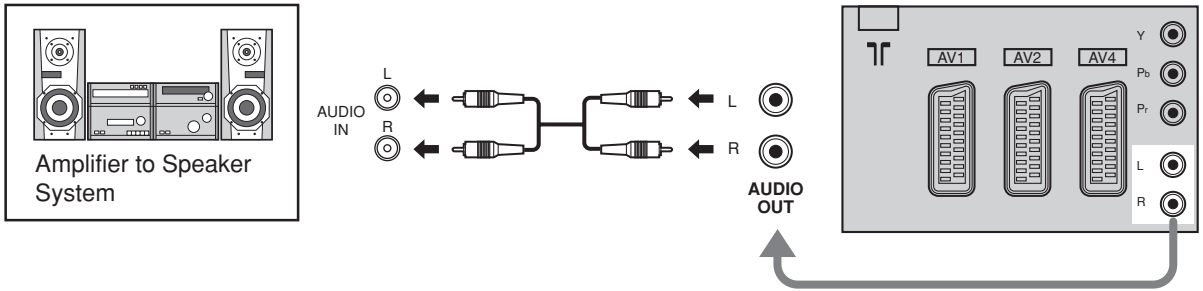

How to connect the AV1 / 2 / 4 Scart terminals

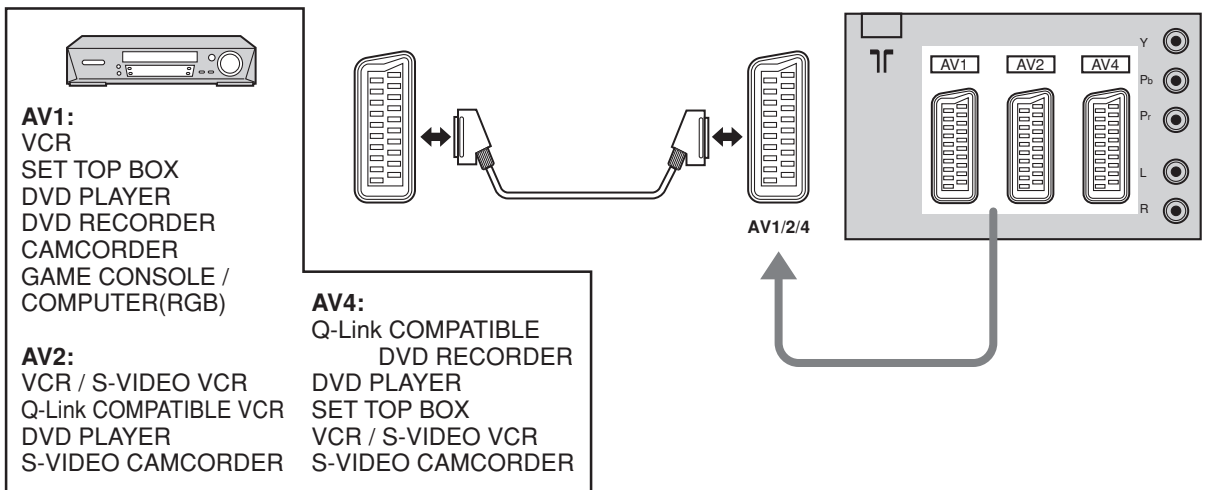

How to connect the Component Input terminals

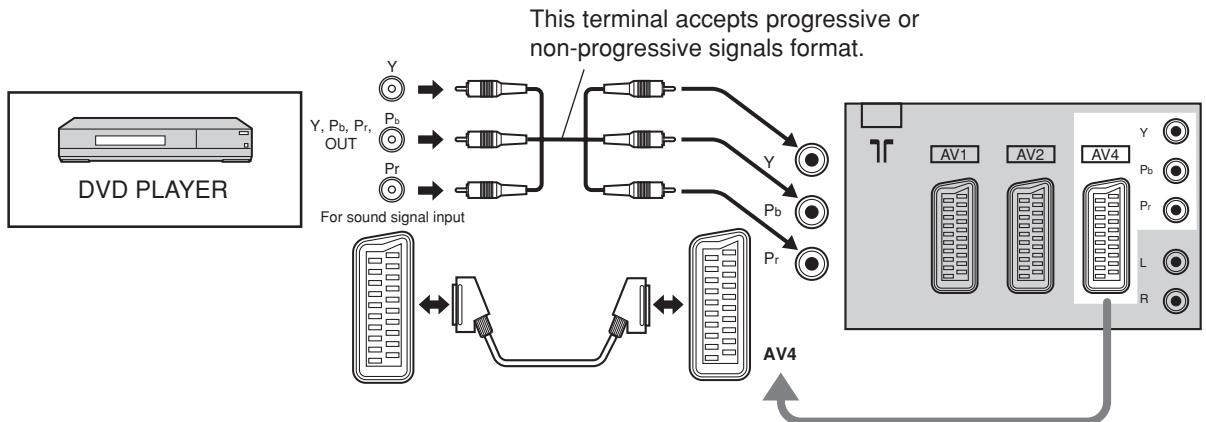

















Notes:

- Additional equipment and cables shown are not supplied with this TV set.
- Do not connect a computer with TTL output (5V) to this set.
- For Scart terminal wiring information see page 46.
- When a Monaural VCR is used, connect the Monaural Audio cable to the Audio "L"(Left) terminal.

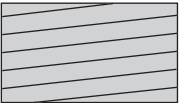
Troubleshooting

If there is a problem with your TV please refer to the table below to determine the symptoms, then carry out the suggested check. If this does not solve the problem, please contact your local Panasonic dealer, quoting the model number and serial number (both found on the rear of the TV).

Symptoms		Checks
Picture	Sound	
 Snowy Picture	 Noisy Sound	Aerial location, direction or connection
 Multiple Images	 Normal Sound	Aerial location, direction or connection
 Interference	 Noisy Sound	Electrical appliances Cars / Motorcycles Fluorescent lights Switch on P-NR in Picture menu to reduce picture noise.
 Normal Picture	 No Sound	Volume level Sound mute switched on.
 No Picture	 No Sound	TV set to AV mode. Not plugged into AC outlet. Not switched on. Picture / Sound controls set at minimum levels. Check if in Standby mode.
 No Colour	 Normal Sound	Colour controls set at minimum levels.
 Poor or Distorted Picture	 Weak or No Sound	Retune Channel (s).
 Normal Picture	 Weak or Distorted Sound	Sound reception may have deteriorated. Switch NICAM setting (Sound menu in Analogue only) to Off until reception improves.
There may be red spots, blue spots and green spots on the screen.	 Normal Sound	This is a characteristic of liquid crystal panels and is not a problem. The liquid crystal panel is built with very high precision technology giving you fine picture details. Occasionally, a few non-active pixels may appear on the screen as a fixed point of blue, green, or red. Please note this does not affect the performance of your LCD.

DVB Troubleshooting

Some problems will only occur when viewing DVB channels. Due to the different techniques involved in digital reception, DVB signal quality can be poor even if you appear to have a strong signal when viewing analogue programmes.

The DVB system requires a good quality signal to provide the best picture. When viewing analogue pictures, interference such as signal reflection from nearby buildings or mountains causes 'ghosting', but still provides a viewable picture. For the DVB system, interference such as this can disrupt the flow of data causing the picture to appear to be made up of large blocks, or to freeze intermittently. If the picture disappears completely, this could mean that signal quality is very poor. If this happens often, you may need to improve your aerial system to provide a better signal. This TV contains a complex microprocessor which enables you to view enhanced digital services. Occasionally this device may need to be reset. This can be done by pressing the standby button on your remote control.

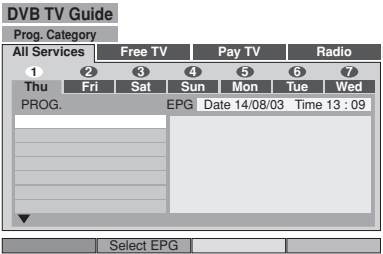
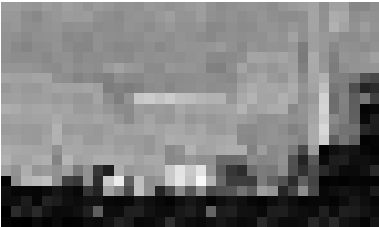
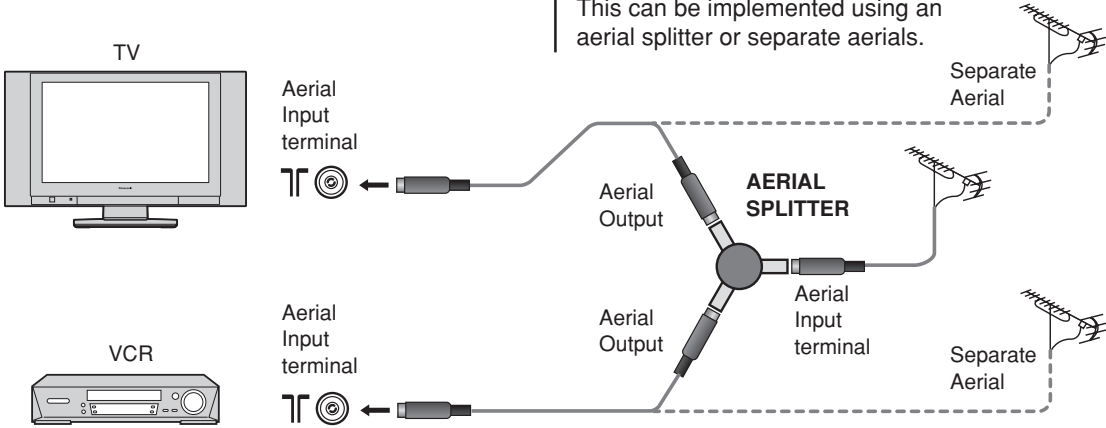
Symptoms	Checks
<p>No DVB channels listed in the TV Guide after Auto Setup.</p> 	<p>Check that DVB transmissions are available from the transmitter you are currently using. If not, try directing the aerial at another local transmitter.</p> <p>Check analogue transmissions. If picture quality is poor, you will need to improve or change your aerial system to receive DVB channels. Consult a local installer.</p>
<p>Blocky interference. Picture freezes intermittently.</p> 	<p>Blocky interference indicates that the signal quality is poor. You should consider improving your aerial system. To check the quality of your signal use the Signal Quality feature (see page 21). Good quality signal – indication is green. Poor quality signal – indication is red.</p>
<p>I have a good aerial system, but still cannot receive DVB stations.</p> 	<p>If you have tried the previous solutions and are still unable to receive DVB channels, you may need to provide dedicated aerial feeds to the TV and other equipment. This can be implemented using an aerial splitter or separate aerials.</p>

Maintenance

To clean this set, wipe with a soft, dry cloth.

If the surfaces are extremely dirty, use a soft cloth dipped in soap-and-water solution or a weak detergent solution.

- Use eyeglass cleaner to remove stubborn dirt from the LCD.
- Never use alcohol, paint thinner or benzine to clean this set.
- Before using chemically treated cloth, read the instructions that came with the cloth carefully.
- Do not wipe the LCD with water.

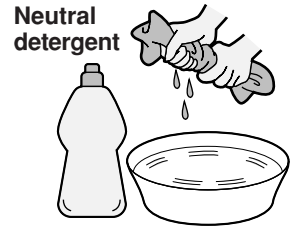

Wipe the cabinet with a soft cloth.

If the cabinet is heavily soiled, wipe with a well-wrung soft cloth dipped in kitchen cleanser (neutral) diluted with water.

CAUTION:

If water or similar substances get inside the monitor via the liquid crystal panel surface, a malfunction may result.

Scart and S-video terminal information

AV1 Scart terminal (RGB, VIDEO)

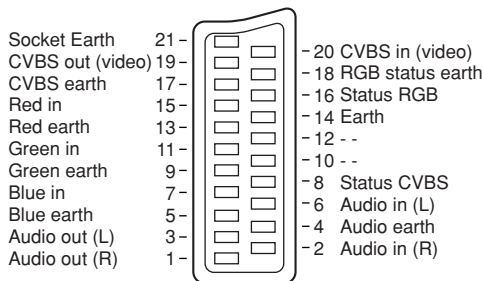

Suitable inputs for AV1 include RGB (Red / Green / Blue).

AV2 Scart terminal (VIDEO, S-VIDEO, Q-Link)

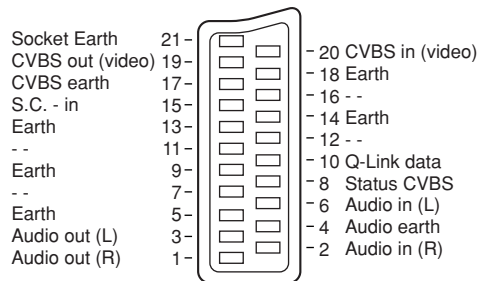

AV2 - Pins 15 and 20 are dependent on AV2 S-VHS / VIDEO switching.

AV3 S-VIDEO 4 pin terminal

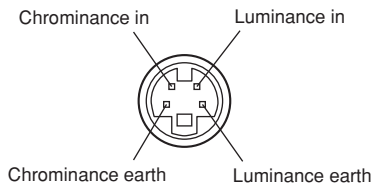

AV4 Scart terminal (RGB, VIDEO, S-VIDEO, Q-Link)

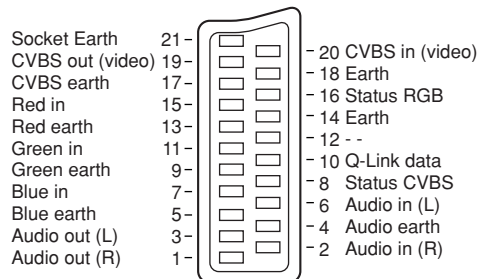

AV4 - Pins 15 and 20 are dependent on AV4 S-VHS / VIDEO switching.

Specifications

	TX-26LXD1	TX-32LXD1
Power Source	AC 220 - 240 V, 50 / 60 Hz	
Power Consumption	Average use : 148 W Standby condition : 1.8 W (Without DVB Timer programmes) 11W (With DVB Timer programmes) Off mode : 1.5 W	Average use : 184 W Standby condition : 1.8 W (Without DVB Timer programmes) 11W (With DVB Timer programmes) Off mode : 1.5 W
LCD	Wide XGA (1,280 × 768 pixels) 15 : 9 aspect ratio LCD panel	
Screen Size	566.4 mm (W) × 339.8 mm (H)	687.4 mm (W) × 412.4 mm (H)
Sound		
Speaker	φ 8 cm × 2 pcs, φ 4 cm × 2 pcs, 8 Ω	
Audio Output	20 W (10 W + 10 W)	
Headphones	M3 (3.5 mm) Jack × 1	
Receiving Systems / Band name	PAL I UHF E21-68. PAL 525/60 Playback of NTSC tape from some PAL Video recorders (VCR). DVB Digital terrestrial services via UHF aerial input. M.NTSC Playback from M.NTSC Videorecorders (VCR). NTSC (AV input only) Playback from NTSC Videorecorders (VCR).	
Aerial - Rear	UHF	
Operating Conditions	Temperature : 5 °C - 35 °C Humidity : 5 % - 90 % RH (non-condensing)	
Connection Terminals		
AV1 (Scart connector)	21 Pin terminal (Audio/Video in, Audio/Video out, RGB in)	
AV2 (Scart connector)	21 Pin terminal (Audio/Video in, Audio/Video out, S-Video in, Q-Link)	
AV3	VIDEO	RCA PIN Type × 1
	S-VIDEO	Mini DIN 4-pin
	AUDIO L - R	RCA PIN Type × 2
AV4	Scart connector	21 Pin terminal (Audio/Video in, Audio/Video out, RGB in, S-Video in, Q-Link)
	Component	Y, Pb, Pr
Output	AUDIO L - R	RCA PIN Type × 2
Others	SD Card slot × 1, PC Card slot × 1	
Dimensions (W × H × D)		
Including TV Stand	844 mm × 571.8 mm × 321 mm	1,000 mm × 651.7 mm × 321 mm
TV Set Only	844 mm × 478 mm × 137 mm	1,000 mm × 558 mm × 137 mm
Mass (Weight)	23 kg Net	27.5 kg Net

Note:

Design and Specifications are subject to change without notice. Weight and Dimensions shown are approximate.



SD Logo is a trademark.

Panasonic

Sales and Support Information

Customer Care Centre

- For UK customers: **08705 357357**
- For Republic of Ireland customers: **01 289 8333**
- Visit our website for product information
www.panasonic.co.uk
- E-mail: **customer.care@panasonic.co.uk**

Direct Sales at Panasonic UK

- Order accessory and consumable items for your product with ease and confidence by phoning our Customer Care Centre Monday – Friday 9:00am – 5:30pm (Excluding public holidays).
- Or go on line through our Internet Accessory ordering application at **www.panasonic.co.uk**.
- Most major credit and debit cards accepted.
- All enquiries transactions and distribution facilities are provided directly by Panasonic UK Ltd.
- It couldn't be simpler!
- Also available through our Internet is direct shopping for a wide range of finished products, take a browse on our website for further details.

Exclusive to Plasma / DVD Ram / LCD Television / LCD Projector product:

*Interested in purchasing an extended guarantee? Please contact your dealer or our Customer Support Department on 01344 476540 or **customer.care@panasonic.co.uk** for more details.*



Trade Mark of the DVB Digital Video Broadcasting Project (1991 to 1996)
TX-26LXD1 Declaration of Conformity No 3033, 10th February 2004
TX-32LXD1 Declaration of Conformity No 3032, 10th February 2004

Customer' Record

The model number and serial number of this product can be found on its rear panel. You should note this serial number in the space provided below and retain this book, plus your purchase receipt, as a permanent record of your purchase to aid in identification in the event of theft or loss, and for Warranty Service purposes.

Model Number _____

Serial Number _____

Panasonic (U. K.) Ltd.

Willoughby Road, Bracknell, Berks RG12 8FP

Web Site <http://www.panasonic.co.uk>

© 2004 Matsushita Electric Industrial Co., Ltd. All Rights Reserved.

MBS0304S0