

# Panasonic®

## Operating Instructions Digital Progressive Plasma Television

Model No. **TH-37PE50B**  
**TH-42PE50B**



The image shown is for illustration only.  
Pedestal stand shown above is optional extra.

(U.K. Standard)



**DVB**



Please read these instructions before operating your set and retain them for future reference.

**English**

TQB0E0168-1

Dear Panasonic Customer,

We hope that you have many years of enjoyment from your new TV. The **Quick Start Guide** section at the beginning of this instruction book will allow you to use the TV as quickly as possible. We recommend that you then read the complete instruction book, and keep it to refer to as you explore the range of advanced features that this Plasma TV offers.

**Analogue and Digital television – what are they?**

Analogue transmission is the system that has been used for many years for broadcasting television programmes. With continuous improvements in technology it is now possible to transmit programmes in a digital format, allowing clearer pictures, more stations and other services to be displayed on screen. Digital television is provided in three different ways; it can be sent along a cable connection direct to your house, broadcast from a satellite, or broadcast using traditional land based (terrestrial) transmitters. The first two options require you to have an extra “set top box” decoder and in the case of satellite, a receiving dish mounted outdoors. While allowing you to receive traditional analogue transmissions in the usual way, this television can also receive terrestrial digital services using an integrated **DVB** (Digital Video Broadcasting) decoder. This allows you to enjoy the new era of digital terrestrial television, including interactive services, without the need for a “set top box” or satellite dish – an adequate roof or loft mounted antenna is all you need.

## Contents

Important Safety Notice .....	3	DVB Setup Menu – overview .....	23
Safety Precautions .....	4	Timer programming menu .....	24
Maintenance .....	5	Profile Edit menu .....	26
Accessories .....	6	Child Lock menu .....	27
Fitting remote control batteries .....	6	DVB Tuning Menu .....	28
AC cord connection .....	7	DVB System Setup .....	29
Cable binding instructions .....	7	Common Interface Module menu .....	30
Quick Start Guide .....	8	System Update menu .....	31
Basic controls: front panel and remote control .....	11	TV Guide - Electronic Programme Guide (EPG) ....	32
Using the On Screen Displays .....	12	Information banner .....	33
Picture menu .....	13	Subtitles ON / OFF .....	33
Sound menu .....	14	Q-Link .....	34
Setup menu .....	15	Aspect Controls .....	35
Tuning menu – overview .....	16	Still .....	36
Tuning menu – Programme edit .....	17	VCR / DVD operation .....	37
Adding / deleting a programme channel .....	17	Teletext operation .....	38
Moving a programme channel .....	17	Audio / video connections .....	41
Renaming a programme channel .....	18	How to connect the Audio Output terminals .....	42
Locking a programme channel .....	18	How to connect the AV1 / 2 / 3 Scart terminals ....	42
Copying programme information to		How to connect the Component Input terminals ..	42
a recording device .....	18	Troubleshooting .....	43
Tuning menu – Auto setup .....	19	DVB Troubleshooting .....	44
Tuning menu – Manual tuning .....	20	Scart terminal information .....	45
Manual tuning (via front panel) .....	20	Component signal that can be displayed .....	45
Owner ID .....	21	Specifications .....	46
Shipping condition .....	22		

**Trademark Credits**

DVB is a trademark of the DVB Digital Video Broadcasting Project (1991 to 1996) .

**CAUTION:**

Symptoms	Check
<p>After-images appear</p> 	<p>Do not allow a still picture to be displayed for an extended period, as this can cause a permanent after-image to remain on the Plasma TV.            Examples of still pictures include logos, video games, computer images, teletext and images displayed in 4:3 mode.            With no signal present, and without any user operation, the Panasonic screensaver will appear automatically after a few minutes to prevent image retention.            During DVB teletext, radio service or menu display, the level of the contrast will decrease automatically after a few minutes to prevent image retention.  <b>Note:</b>            The permanent after-image on the Plasma TV resulting from fixed image use is not an operating defect and as such is not covered by the Warranty.            This product is not designed to display fixed images for extended periods of time.</p>

# Important Safety Notice

## WARNING

- 1) To prevent damage which may result in fire or shock hazard, do not expose this appliance to dripping or splashing.  
Do not place containers with water (flower vase, cups, cosmetics, etc.) above the set. (including on shelves above, etc.)
- 2) To prevent electric shock, do not remove cover. No user serviceable parts inside. Refer servicing to qualified service personnel.
- 3) Do not remove the earthing pin on the power plug. This apparatus is equipped with a three pin earthing-type power plug. This plug will only fit an earthing-type power outlet. This is a safety feature. If you are unable to insert the plug into the outlet, contact an electrician.  
Do not defeat the purpose of the earthing plug.

## CAUTION

- 1) This appliance is intended for use in environments which are relatively free of electromagnetic fields. Using this appliance near sources of strong electromagnetic fields or where electrical noise may overlap with the input signals could cause the picture and sound to wobble or cause interference such as noise to appear. To avoid the possibility of damage to this appliance, keep it away from sources of strong electromagnetic fields.
- 2) If a static electricity discharge occurs inside the front cover, the screen may momentarily flicker. This is not a malfunction.  
The screen will return to normality in a short while.

To prevent electric shock, ensure the grounding pin on the AC cord power plug is securely connected.

## IMPORTANT: THE MOULDED PLUG

FOR YOUR SAFETY, PLEASE READ THE FOLLOWING TEXT CAREFULLY.

This appliance is supplied with a moulded three pin mains plug for your safety and convenience. A 5 amp fuse is fitted in this plug. Shall the fuse need to be replaced, please ensure that the replacement fuse has a rating of 5 amps and that it is approved by ASTA or BSI to BS1362.

Check for the ASTA mark  or the BSI mark  on the body of the fuse.

If the plug contains a removable fuse cover, you must ensure that it is refitted when the fuse is replaced.

If you lose the fuse cover the plug must not be used until a replacement cover is obtained.

A replacement fuse cover can be purchased from your local Panasonic Dealer.

**If the fitted moulded plug is unsuitable for the socket outlet in your home, then the fuse shall be removed and the plug cut off and disposed of safely. There is a danger of severe electrical shock if the cut off plug is inserted into any 13 amp socket.**

If a new plug is to be fitted, please observe the wiring code as shown below.

If in any doubt, please consult a qualified electrician.

**WARNING: — THIS APPARATUS MUST BE EARTHED.**

**IMPORTANT: —**The wires in this mains lead are coloured in accordance with the following code: —  
Green-and-Yellow: Earth    Blue: Neutral    Brown: Live

As the colours of the wire in the mains lead of this appliance may not correspond with the coloured markings identifying the terminals in your plug, proceed as follows.

The wire which is coloured GREEN-AND-YELLOW must be connected to the terminal in the plug which is marked with the letter E or by the Earth symbol  or coloured GREEN or GREEN-AND-YELLOW.

The wire which is coloured BLUE must be connected to the terminal in the plug which is marked with the letter N or coloured BLACK.

The wire which is coloured BROWN must be connected to the terminal in the plug which is marked with the letter L or coloured RED.

How to replace the fuse. Open the fuse compartment with a screwdriver and replace the fuse.

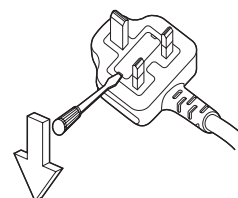

# Safety Precautions

## WARNING

### ■ Setup

**This Plasma TV is for use only with the following optional accessories. Use with any other type of optional accessories may cause instability which could result in the possibility of injury.**

(All of the following accessories are manufactured by Matsushita Electric Industrial Co., Ltd.)

- Pedestal ..... TY-ST42PA50W
- Display stand ..... TY-S37PA50W (TH-37PE50B)  
TY-S42PA50W (TH-42PE50B)
- Wall-hanging bracket (vertical) ..... TY-WK42PV3W, TY-WK42PV2W
- Wall-hanging bracket (angle) ..... TY-WK42PR2W

Always be sure to ask a qualified technician to carry out installation.

**Do not place the Plasma TV on sloped or unstable surfaces.**

- The Plasma TV may fall off or tip over.

**Do not place any objects on top of the Plasma TV.**

- If water is spilt onto the Plasma TV or foreign objects get inside it, a short-circuit may occur which could result in fire or electric shock. If any foreign objects get inside the Plasma TV, please consult your local Panasonic dealer.

**Ventilation should not be impeded by covering the ventilation openings with items such as newspapers, table cloths and curtains.**

**If using the pedestal (optional accessory), leave a space of at least 10 cm at the top, left and right, at least 6 cm at the bottom, and at least 7 cm at the rear. If using some other setting-up method, leave a space of at least 10 cm at the top, bottom, left and right, and at least 1.9 cm at the rear.**

**Electromagnetic interference may occur if electronic equipments are placed near each other.**

- It will cause interference in image, sound, etc. In particular, keep video equipment away from this product.

**Keep unneeded small parts and other objects out of the reach of small children. These objects can be accidentally swallowed. Also, be careful about packaging materials and plastic sheets.**

### ■ When using the Plasma TV

**The Plasma TV is designed to operate on 220 - 240 V AC, 50/60 Hz.**

**Do not cover the ventilation holes.**

- Doing so may cause the Plasma TV to overheat, which can cause fire or damage to the Plasma TV.

**Do not insert any foreign objects into the Plasma TV.**

- Do not insert any metal or flammable objects into the ventilations holes or drop them onto the Plasma TV, as doing so can cause fire or electric shock.

**Do not remove the cover or modify it in any way.**

- High voltages which can cause severe electric shocks are present inside the Plasma TV. For any inspection, adjustment and repair work, please contact your local Panasonic dealer.

**Ensure that the mains plug is easily accessible.**

**Securely insert the power cord plug as far as it will go.**

- If the plug is not fully inserted, heat may be generated which could cause fire. If the plug is damaged or the wall socket plate is loose, do not use them.

**Do not handle the power cord plug with wet hands.**

- Doing so may cause electric shocks.

**Do not do anything that may damage the power cable. When disconnecting the power cable, pull on the plug body, not the cable.**

- Do not damage the cable, make any modifications to it, place heavy objects on top of it, heat it, place it near any hot objects, twist it, bend it excessively or pull it. To do so may cause fire and electric shock. If the power cable is damaged, have it repaired at your local Panasonic dealer.

**If the Plasma TV is not going to be used for any prolonged length of time, unplug the power cord plug from the wall outlet.**

## Safety Precautions

### ■ If problems occur during use

**If a problem occurs (such as no picture or no sound), or if smoke or an abnormal odour starts to come out from the Plasma TV, immediately unplug the power cord plug from the wall outlet.**

- If you continue to use the Plasma TV in this condition, fire or electric shock could result. After checking that the smoke has stopped, contact your local Panasonic dealer so that the necessary repairs can be made. Repairing the Plasma TV yourself is extremely dangerous, and should never be attempted.

**If water or foreign objects get inside the Plasma TV, if the Plasma TV is dropped, or if the cabinet becomes damages, disconnect the power cord plug immediately.**

- A short circuit may occur, which could cause fire. Contact your local Panasonic dealer for any repairs that need to be made.

### CAUTION

### ■ When using the Plasma TV

**Do not bring your hands, face or objects close to the ventilation holes of the Plasma TV.**

- Heated air comes out from the ventilation holes at the top of Plasma TV will be hot. Do not bring your hands or face, or objects which cannot withstand heat, close to this port, otherwise burns or deformation could result.

**Be sure to disconnect all cables before moving the Plasma TV.**

- If the Plasma TV is moved while some of the cables are still connected, the cables may become damaged, and fire or electric shock could result.

**Disconnect the power cord plug from the wall socket as a safety precaution before carrying out any cleaning.**

- Electric shocks can result if this is not done.

**Clean the power cable regularly to prevent it becoming dusty.**

- If dust built up on the power cord plug, the resultant humidity can damage the insulation, which could result in fire. Pull the power cord plug out from the wall outlet and wipe the mains lead with a dry cloth.

**This Plasma TV radiates infrared rays, therefore it may affect other infrared communication equipment. Install your infrared sensor in a place away from direct or reflected light from your Plasma TV.**

## Maintenance

**The front of the display panel has been specially treated. Wipe the panel surface gently using only a cleaning cloth or a soft, lint-free cloth.**

- If the surface is particularly dirty, wipe with a soft, lint-free cloth which has been soaked in pure water or water to which a small amount of neutral detergent has been added, and then wipe it evenly with a dry cloth of the same type until the surface is dry.
- Do not scratch or hit the surface of the panel with fingernails or other hard objects, otherwise the surface may become damaged. Furthermore, avoid contact with volatile substances such as insect sprays, solvents and thinner, otherwise the quality of the surface may be adversely affected.

**If the cabinet becomes dirty, wipe it with a soft, dry cloth.**

- If the cabinet is particularly dirty, soak the cloth in water to which a small amount of neutral detergent has been added and then wring the cloth dry. Use this cloth to wipe the cabinet, and then wipe it dry with a dry cloth.
- Do not allow any detergent to come into direct contact with the surface of the Plasma TV. If water droplets get inside the unit, operating problems may result.
- Avoid contact with volatile substances such as insect sprays, solvents and thinner, otherwise the quality of the cabinet surface may be adversely affected or the coating may peel off. Furthermore, do not leave it for long periods in contact with articles made from rubber or PVC.

# Accessories

Check that you have the accessories and items shown

Operating Instructions

Remote Control Transmitter  
(EUR7651070)

Mains Lead  
(K2CT3DH00018)

Clamper  
(TMME206) × 2

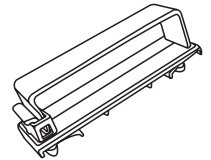
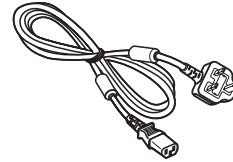
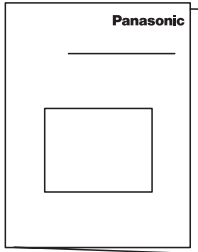

Batteries for the Remote Control Transmitter  
(2 × R6 (UM3) size)

Pan European Guarantee Card

1 Year Guarantee Registration

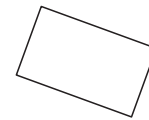
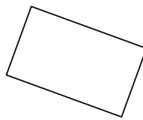

# Fitting remote control batteries

1

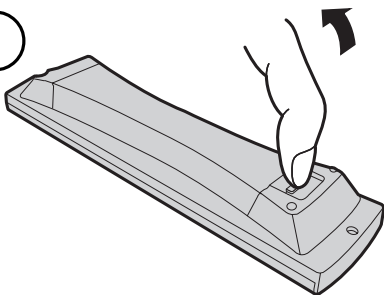

Pull and hold the hook, then open the battery cover.

2

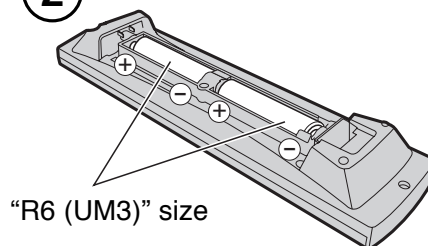

“R6 (UM3)” size

Insert batteries - note correct polarity ( + and -).

3

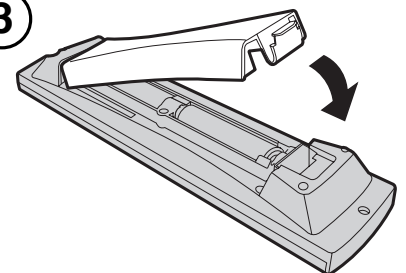

Replace the cover.

- Make sure that the batteries are fitted the correct way round.
- Do not mix old batteries with new batteries. Remove old, exhausted batteries immediately.
- Do not mix different battery types, i.e. Alkaline and Manganese or use rechargeable (Ni - Cad) batteries.

**Batteries, packaging and old equipment should not be disposed of as domestic waste, but in accordance with the applicable regulations.**



## AC cord connection

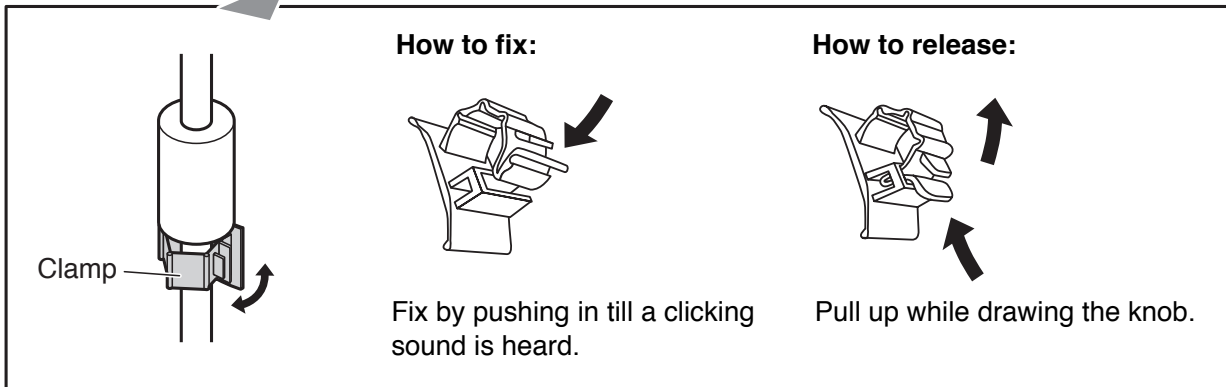
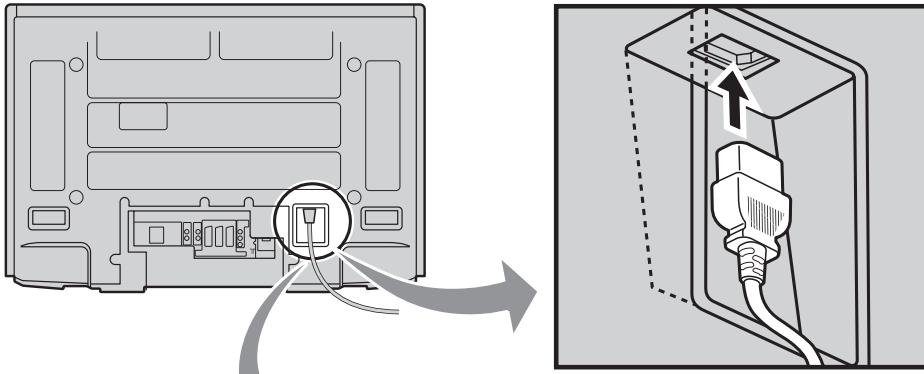

## Cable binding instructions

### For using the TY-ST42PA50W

#### Attach the bands.

Insert the spigot on the two bands into the pedestal.

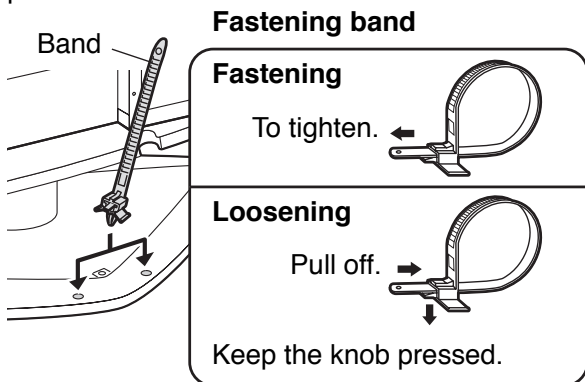

#### Connect cables.

Example of "connection cable routing"

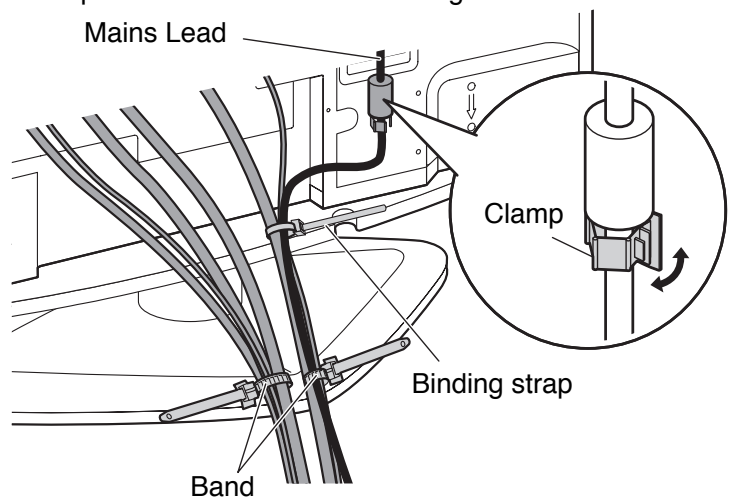

#### Note:

Refer to the operating instruction book of the pedestal.

# Quick Start Guide

## Connection and setting up options

**Note:** Please ensure that the unit is disconnected from the mains before attaching or disconnecting any leads.

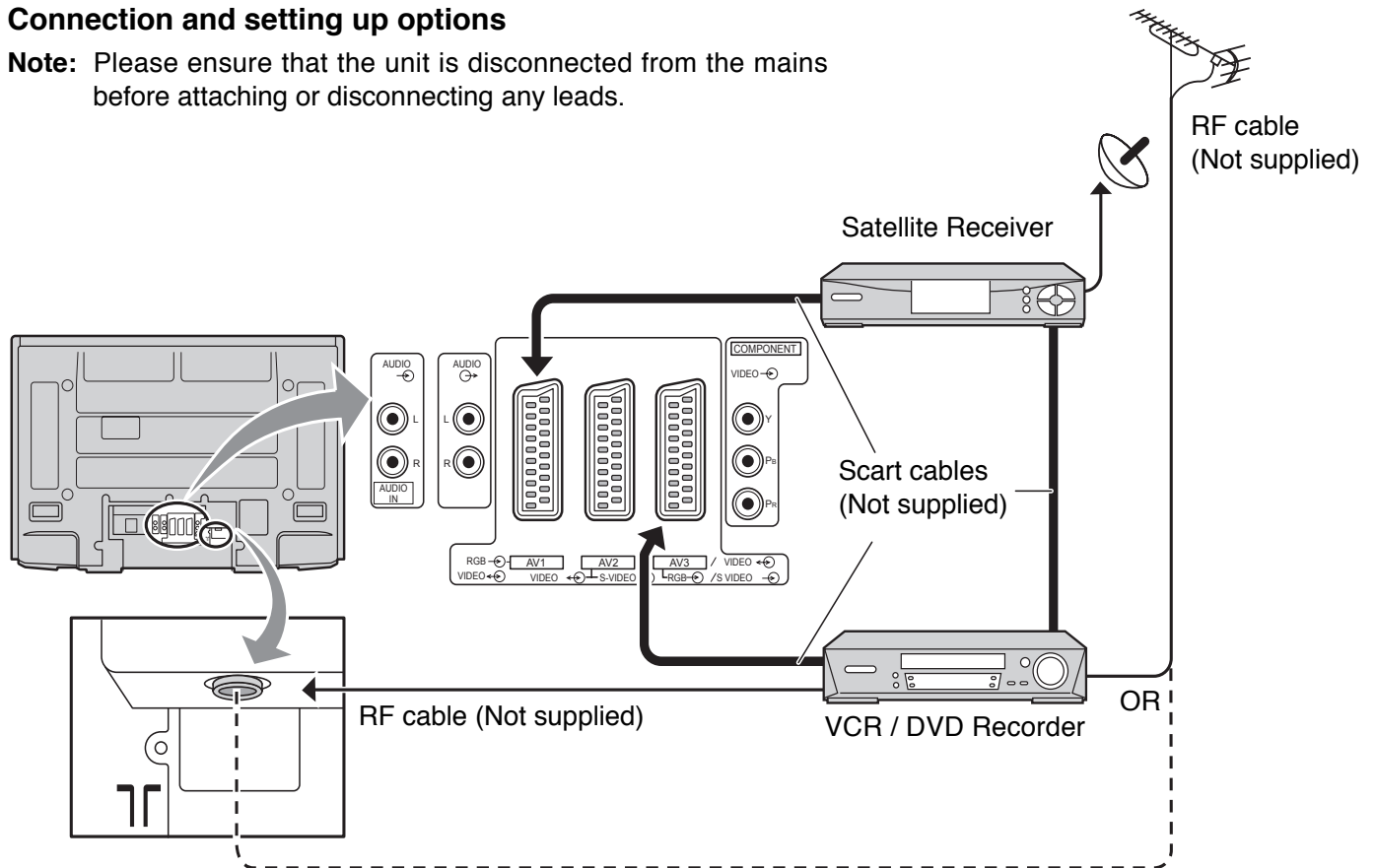

### Scart Connections

- The VCR / DVD Recorder can be connected to the TV using a Scart cable, if you are using a Scart equipped VCR / DVD Recorder.
- Use the TV's any Scart terminal for any VCR. Always use a "fully wired" Scart cable.
- Use the TV's AV1 or AV3 Scart terminal for any DVD Recorder. Always use a "fully wired" Scart cable.
- Use the TV's AV1 or AV3 Scart terminal for Satellite Receiver. Always use a "fully wired" Scart cable.

### RF Connection

- Connect the RF cable to the "Aerial In" terminal of the VCR / DVD Recorder and an RF cable from the VCR / DVD Recorder "Aerial Out" terminal to the TV Aerial terminal ( ㄗ ).

### Notes:

- If using a "Q-Link" VCR / DVD Recorder, then the AV1 Scart of the VCR / DVD Recorder must be connected to the AV2 or AV3 terminal of the TV. If your VCR or DVD Recorder is not a "Q-Link" device, please consult the operating instruction book for that product. Further information on Q-Link can be found on page 34.
- Further details of Audio / Video connections can be found on page 41, 42.
- Additional equipment and cables are not supplied.



# Quick Start Guide

## 1 Connect the mains plug to the wall socket.

Press the [⏻/⏻] switch on the TV set to turn the set on.

To switch the TV set to Standby mode, press the [⏻] button on the remote control.

The TV set can be switched on by pressing the [⏻] button again if it was in Standby mode.

### Note:

This TV will still consume some power even in the Off mode, as long as the mains plug is still connected to a live mains socket.

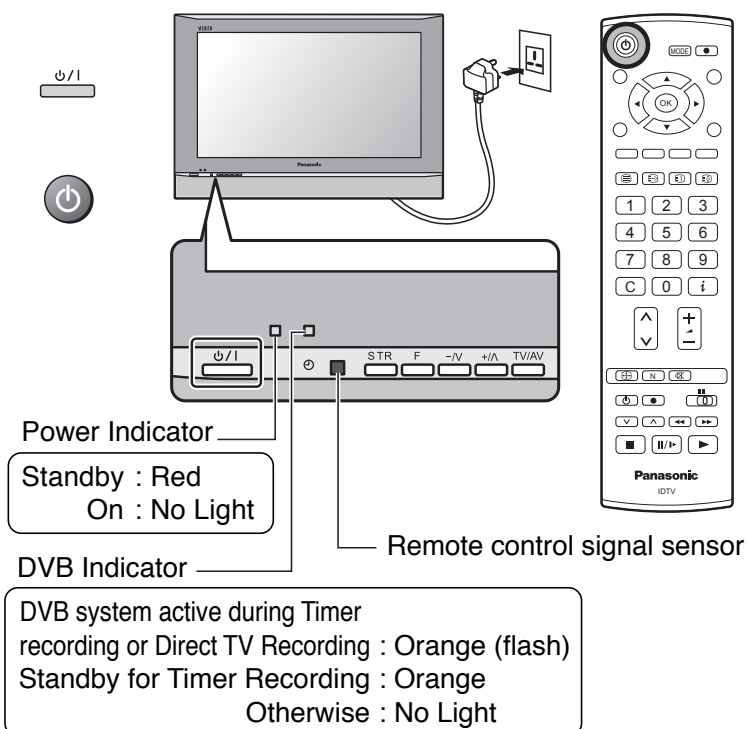

## 2 Programmes will appear immediately if your dealer has programmed the TV for you.

If the TV has not been programmed for you then **Auto setup** will begin.

The TV will search for DVB stations and Analogue stations:

TV stations will be located, sorted into order and stored ready for use. Stations are sorted into the following order:

- **DVB Stations:** Are sorted by their logical channel number sent by the broadcasters, which can be made the favourites list by Profile Edit. See page 26.
- **Analogue Stations:** Are sorted into channel order, but can be changed to your preference. See page 17.

In this setup, usually Analogue auto setup screen may not be displayed. The sorted programme order depends upon the TV signal, the broadcasting system, and reception conditions.

Prog.	Channel	Service Name	NetID	TS ID	Quality
4	30	BBC NEWS 24	12302	4158	9
5	30	BBC1	12302	4158	9
6	30	CBBC Channel	12302	4158	9
7	30	BBC Radio Wales	12302	4158	9
8	30	BBC Radio Cymru	12302	4158	9

This will take about 3 mins.

Exit

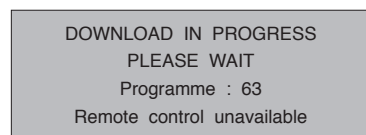
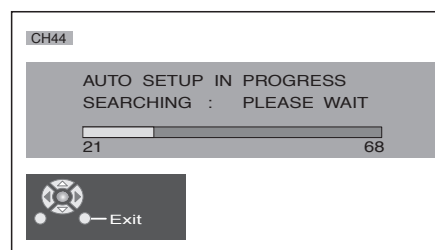

## 3 TV to VCR or DVD Recorder Download

If a "Q-Link", "NEXTVIEWLINK" or compatible recording device has been connected to a Scart terminal (AV2 or AV3) before starting Step 1, programme information will be downloaded to that device.

Only the analogue programme positions will be downloaded to the recording device, in the same order as stored in the TV. See page 34. Not all VCRs / DVD Recorders support this download of programme information, some may require to be started manually.

Refer to the recording device's operating instruction book.

If a recording device other than those described above has been connected, then there will be no download operation.

### Notes:

- If the recording device has not accepted download data from the TV, you may need to select the Download option from the device's menu system. Refer to the recording device's operating instruction book.
- If Q-Link is not operating correctly, check the following :
  - The Scart cable is connected to the TV's Scart terminal, AV2 or AV3, and correctly setup in the menu.
  - The Scart cable is connected to the recording device's compatible (Q-Link, NEXTVIEWLINK or similar technology) Scart terminal.
  - The Scart cable is a "fully wired" type.
- For further information on Q-Link and connecting equipment, see page 34, 42, 45.

# Quick Start Guide

## 4 Owner ID

As an added feature, this TV has the option of adding a security code (Owner ID) and personal details into its memory, so that in the unfortunate event of theft it will help the Police to trace the owner.

Using the numeric buttons to enter required 4 digit Owner ID **PIN NUMBER**.

If a 4 digit **PIN NUMBER** was entered, you will be taken automatically to the **NAME** line.

If not, using the left or right cursor buttons move to the **NAME** line.

Change character using the up or down cursor buttons.

Select the character position using the left or right cursor buttons.

Repeat above until **NAME**, **HOUSE NUMBER** and **POSTCODE** are entered.

Press the **OK** button to store the details.

Press the **OK** button again, when you are asked "Are you sure ?".

For further information on Owner I.D., see page 21.

A space is provided on page 21 to write down the **PIN NUMBER** for future reference.

**Your Plasma TV is now ready for use.**

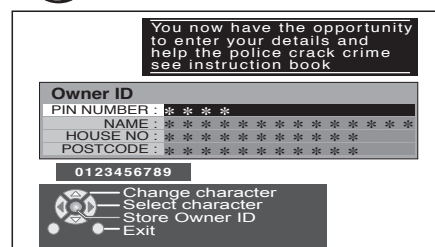
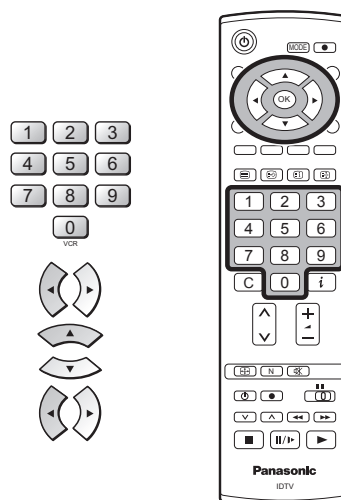

## 5

To view a list of the stations that have been found, press the **GUIDE** button.

Use the cursor buttons to move the cursor bar.

Use the programme change button to step through the guide page by page.

To view the selected programme, move the cursor to the channel and then press the **OK** button.

The guide can be cleared from the screen using the **EXIT** button.

**DVB TV Guide** (DVB mode) See page 32.

To make stations easier to find, specific stations can be listed by category; press the **Yellow** button to show a category.

The chosen category name is shown on screen.

For example, if you select **Free TV** and press the **OK** button, only 'free-to-air' stations will be listed – you can view any of these now.

If you select **Pay TV** and press the **OK** button, only subscription stations will be listed – you will need to contact the service provider to find out how to subscribe to these stations.

GUIDE

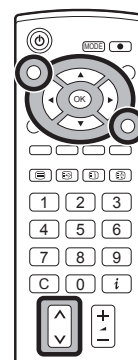

Analogue mode

Analogue Programme Guide				
Prog.	Name	Chan.	Prog. Name	Chan.
VCR		CH21	13	--
1	BBC1	CH44	14	--
2	BBC2	CH51	15	--
3	ITV	CH41	16	--
4	S4C	CH47	17	--
5		CH23	18	--
6		CH26	19	--
7		CH58	20	--
8		--	21	--
9		--	22	--
10		--	23	--
11		--	24	--
12		--	--	--

DVB mode

DVB TV Guide: Landscape					Thu 05/08/04 18:50	
Time	Category	Prog. Name	Prog. Type			
20:00-21:00	All Services	Coronation Street: We open in the Battersea	All Types			
Time: 19:30	120:00	120:30	121:00	121:30		
1	BBC1	Eastender	DIY SOS	The Bill	Red Cap	
2	BBC2	Hot Wars		Holiday Program	So	
21	ITV1	Emmerdal	Coronation Street	The Bill		
44	Channel4	10 O'clock News	BBC	Pepsi Char	Good bye	Hell
122	live	Panorama	Sex And The City	Terminator		
142	ITV2	I'm A Celebrity	Pop Idol	News	The	
144	SC4	Rugby	15 To1	The Bill		

# Basic controls: front panel and remote control

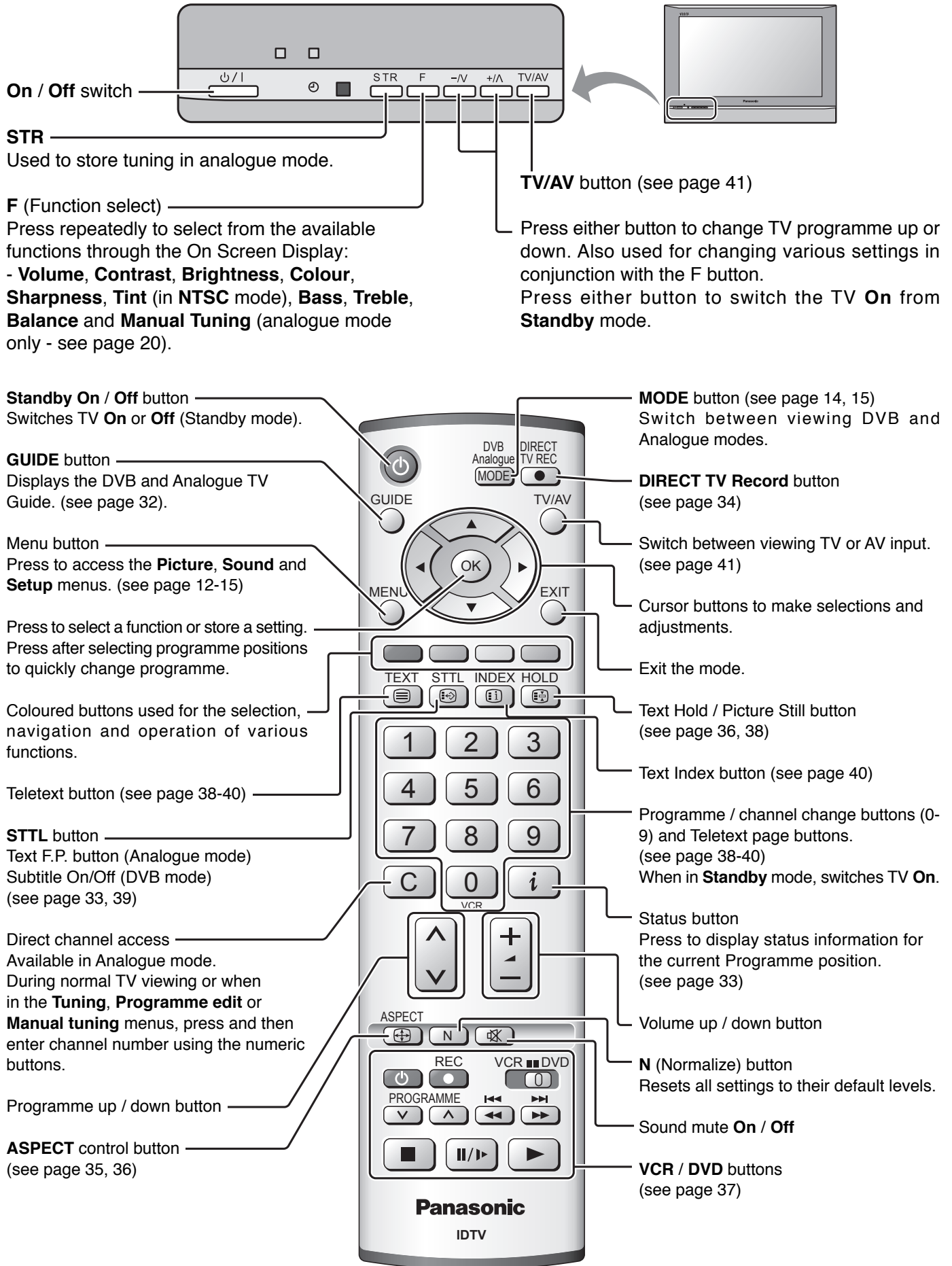

# Using the On Screen Displays

Many features available on this TV can be accessed via the On Screen Display menu system. Use the remote control as shown below to access and adjust features as desired.

The **MENU** button is used to open the main menus and also to return to the previous menu.

The up and down cursor buttons are used to move the cursor and select menus.

The left and right cursor buttons are used to access menus, adjust levels or to select from a range of options.

The **OK** button is used with a number of features to store settings after adjustments have been made or options have been set.

The **EXIT** button is used to exit the menu system and return to the normal viewing screen.

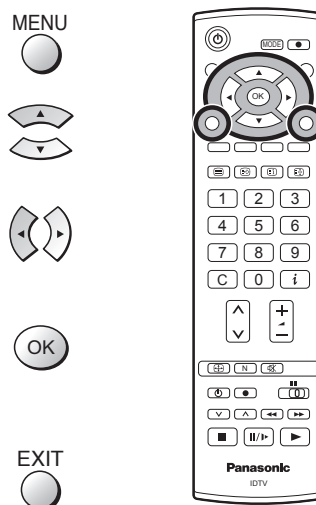

An On Screen Help box is displayed whenever a menu is displayed on the TV. This Help box indicates which buttons on the remote control are used to navigate the menu shown, see above for descriptions of button functions.

**Note:**

The Help box is not shown in the menu pictures in this instruction book due to space limitations.

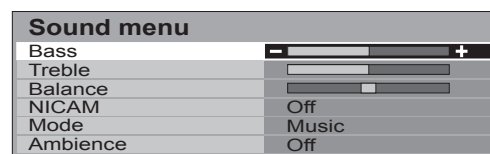

**ON SCREEN HELP  
'Instructions' box**

# Picture menu

Press the **MENU** button.

Move to **Picture menu**.

Access **Picture menu**.

Move to menu option.

Adjust chosen option or access chosen menu.

Press the **EXIT** button at any time to go back to watching TV.

MENU



EXIT

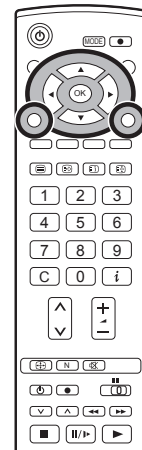

**Viewing mode** The Viewing mode menu allows you to select three different screen settings - **Dynamic**, **Normal** and **Cinema**.

In each Viewing mode setting, Contrast, Brightness, Colour, Sharpness, Tint (in NTSC only), Colour balance, Colour management, P-NR, MPEG NR and 3D-COMB can be adjusted and stored to suit your particular viewing requirement. (e.g., you may require different settings for viewing sports, films, news etc.) Changes to any settings in a viewing mode will affect all signal sources: RF, AV1, AV2, AV3 and Component. Changes will be stored automatically.

By analysing and processing the incoming picture, all three modes feature automatic enhancement.

## Contrast, Brightness, Colour, Sharpness

Increase or decrease the levels of these options according to your personal preference.

**Tint** With an NTSC signal source connected to the TV, the picture hue can be adjusted to suit your taste.

**Colour balance** Allows you to set the overall colour tone of the picture. Choose from **Cool**, **Normal** and **Warm**.

**Colour management** Enables vivid colour adjustment automatically.

**P-NR** Automatically reduces unwanted picture noise. Not available during HD signal input.

**MPEG NR** Reduces MPEG noise. Allows you to choose from **Off**, **Min**, **Mid** and **Max**. This function is effective in reducing the digital block noise when viewing DVD, VCD or digital broadcast ing. The effect will be changed based on the scene and image. **MPEG:** Compression technology of the image signal adopted by DVD, VCD or digital broadcasting.

**3D-COMB** Not available in DVB mode. Occasionally, whilst viewing still or slow moving pictures, colour patterning may be seen. Set 3D-COMB to **On** to display sharper and more accurate colours. Displayed only when receiving PAL or NTSC signals. Not displayed during RGB Video, S-Video and component input mode.

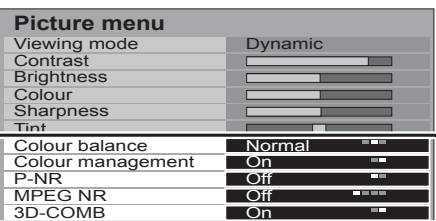
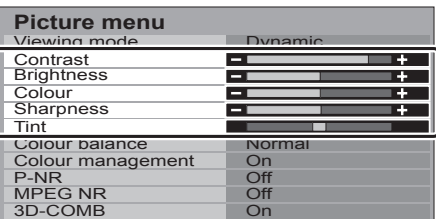
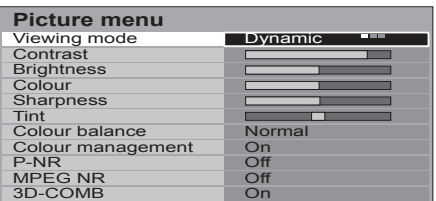
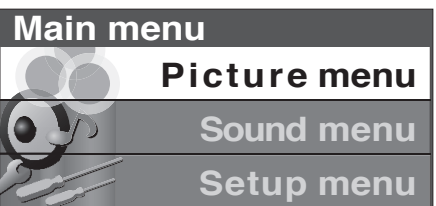

# Sound menu

Press the **MODE** button to select DVB or Analogue mode.

Press the **MENU** button.

Move to **Sound menu**.

Access **Sound menu**.

Move to menu option.

Adjust chosen option or access chosen menu.

Press the **EXIT** button at any time to go back to watching TV.

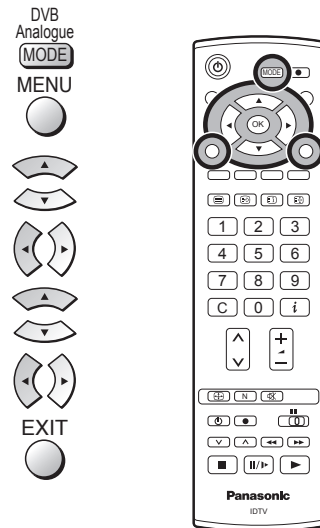

- Bass**                      Increase or decrease level to enhance or minimise lower, deeper sound output.
- Treble**                    Increase or decrease level to enhance or minimise sharper, higher sound output.
- Balance**                  The levels of sound between the left and right speakers can be adjusted to suit your listening position.
- NICAM**                    Not available in DVB mode.  
Select **On** to provide stereo sound reproduction. Select **Off** for FM Mono sound output.  
If Nicam Mono is being transmitted select either FM Mono (Off), Nicam Mono I (M1) or Nicam Mono II (M2). The options depend upon the signal being transmitted. If reception deteriorates it is advisable to switch to FM Mono (Off).
- Mode**                      Sound quality can be improved when watching music scene or drama by selecting the appropriate **Music** or **Speech** mode.
- Ambience**                Ambience provides a dynamic enhancer to simulate improved spatial effects.

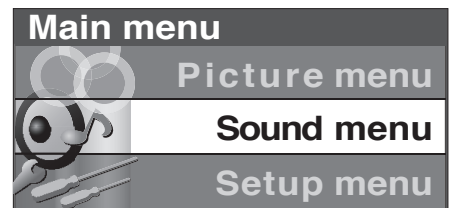

## Analogue mode

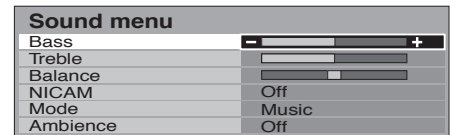

## DVB mode





# Setup menu

Press the **MODE** button to select DVB or Analogue mode.

Press the **MENU** button.

Move to **Setup menu**.

Access **Setup menu**.

Move to menu option.

Adjust chosen option or access chosen menu.

Press the **EXIT** button at any time to go back to watching TV.

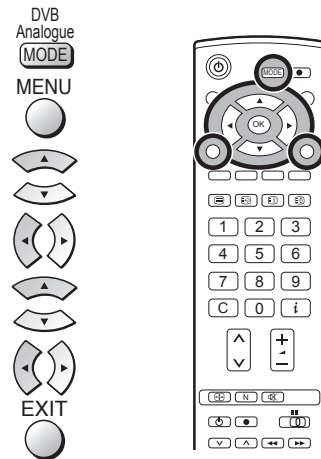

**Q-Link** Allows you to select which AV terminal is to be used for data communication between this TV and a compatible recording device. Choose from **AV2** and **AV3**. See page 34.

**AV2 / AV3 out** Offers a choice of signals to send to the Scart terminal selected in the Q-Link option. You can choose from the current TV (**Analogue, DVB**) programme position, the signal entering **AV1 / AV2 / AV3** or **Monitor** - the picture displayed on screen.

**Note:** Component signal input cannot be output to these Scart terminals.

**Teletext** Allows you to choose between **FASTTEXT** or **List** mode. See page 38-40.

**Off timer** Switches the TV off within a preset time which you can choose from between 0 to 90 minutes in 15 minute intervals.

**Side panel** Allows you to choose from **Off, Low, Mid** and **High**. Do not display a picture in 4:3, 14:9, Picture and text modes for an extended period, as this can cause an after-image to remain on the side panels either side of the display field. To prevent the appearance of such an after-image, illuminate the side panels.

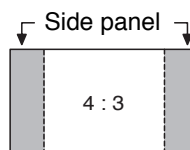

**Power save** By reducing the brightness of picture, power consumption can be lowered.

**Power on preference** Set to **TV** to view picture from TV tuner. Set to **AV** to view input from an external equipment connected to a Scart socket, e.g. satellite receiver.

**Note:** The external equipment must be switched on and sending a control signal for automatic switching at power on to occur.

**Tuning Menu** Provides access to many other features including **Programme edit** and **Auto setup**. See page 17-19.

**DVB Setup Menu** Provides access to setup the DVB operations. See page 23.

**Owner ID** Allows you to enter a security code and address information. See page 21.

**Shipping condition** Allows you to clear all tuning information and reset all control levels back to factory settings. See page 22.

**Volume correction** During AV mode, Volume correction is displayed. You can adjust volume level of AV mode. Volume level is memorised.

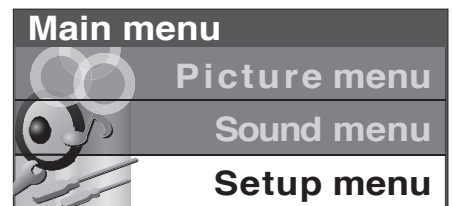

Analogue TV mode

Setup menu	
Q-Link	AV2
AV2 out	Monitor
Teletext	FASTTEXT
Off timer	Off
Side panel	High
Power save	Off
Power on preference	TV
Tuning Menu	
Owner ID	
Shipping condition	

DVB mode

Setup menu	
Q-Link	AV2
AV2 out	Monitor
Teletext	FASTTEXT
Off timer	Off
Side panel	High
Power save	Off
Power on preference	TV
DVB Setup Menu	
Owner ID	
Shipping condition	

AV mode

Setup menu	
Q-Link	AV2
AV2 out	Monitor
Teletext	FASTTEXT
Off timer	Off
Volume correction	
Side panel	High
Power save	Off
Power on preference	TV

# Tuning menu – overview (Analogue mode)

## In Analogue mode

Press the **MENU** button.

Move to **Setup menu**.

Access **Setup menu**.

Move to **Tuning Menu**.

Access **Tuning Menu**.

Move to menu option.

Adjust chosen option or access chosen menu.

Press the **EXIT** button at any time to go back to watching TV.

Press the **OK** button after having adjusted some features to store the new settings as the default (replacing the factory setting).

MENU



EXIT

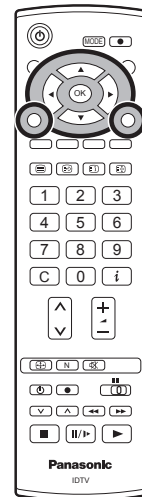

**Programme edit** Access in order to customize your programme settings (e.g., adding or deleting a programme position). See page 17, 18.

**Auto setup** Allows you to automatically retune the TV. Useful if you move house and wish to retune your TV to the local stations. See page 19.

**Manual tuning** Allows individual programme positions to be tuned manually. See page 20.

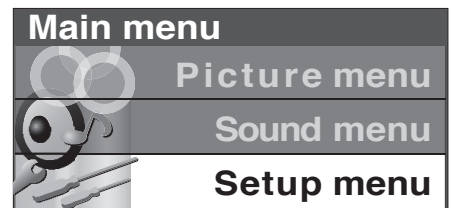

Setup menu	
Q-Link	AV2
AV2 out	Monitor
Teletext	FASTEXT
Off timer	Off
Side panel	High
Power save	Off
Power on preference	TV
Tuning Menu	Access
Owner ID	
Shipping condition	

Tuning Menu	
Programme edit	Access
Auto setup	
Manual tuning	

Programme edit			
Prog.	Chan.	Name	Lock
1	: CH44	ABC	Off
2	: CH51	XYZ	Off
3	: CH41	FTP	Off
4	: CH47	123	Off
5	: CH37	456	Off

Delete	Add	Move	Download
--------	-----	------	----------



# Tuning menu – Programme edit (Analogue mode)

## In Analogue mode

Press the **MENU** button.

Move to **Setup menu**.

Access **Setup menu**.

Move to **Tuning Menu**.

Access **Tuning Menu**.

Move to **Programme edit**.

Access **Programme edit**.

Move to choose programme position (e.g., Prog. 3).

Make required change, e.g., moving a programme channel (see the relevant procedure below).

Press the **EXIT** button at any time to go back to watching TV.

Press the **OK** button after having adjusted some features to store the new settings.

MENU



EXIT

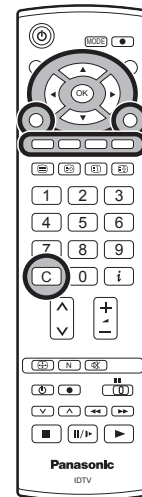

## Adding / deleting a programme channel

Move the cursor to the programme to be deleted or added.



Press the **Green** button to add a programme channel to the programme position, or the **Red** button to delete one.

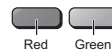

Press the same button again to confirm your decision.

Programme edit			
Prog.	Chan.	Name	Lock
1	CH44	ABC	Off
2	: CH51	XYZ	Off
3	: CH41	FTP	Off
4	: CH47	123	Off
5	: CH37	456	Off

Add Cancel

## Moving a programme channel

Move the cursor to the programme to be moved.



Press the **Yellow** button.



Choose the new position for the programme channel.



Press the **Yellow** button again to confirm your decision.

Programme edit			
Prog.	Chan.	Name	Lock
1	CH44	ABC	Off
2	: CH51	XYZ	Off
3	: CH41	FTP	Off
4	: CH47	123	Off
5	: CH37	456	Off

Confirm Cancel

# Tuning menu – Programme edit (Analogue mode)

## Renaming a programme channel

Move to the **Name** column.



Choose the new character. The box at the bottom of the screen shows the character currently selected.



Move to the next character position.



Continue until renaming is done.

Press the **OK** button to store the new name.



Programme edit			
Prog.	Chan.	Name	Lock
1	CH44	■	Off
2	CH51	XYZ	Off
3	CH41	FTP	Off
4	CH47	123	Off
5	CH37	456	Off

ABCDEFGHIJKLMNOPQRST  
UVWXYZ+- ■ 0123456789

## Locking a programme channel

You may wish to lock a programme channel to prevent access to it.

Move to the **Lock** column.



Choose between Lock **On** or Lock **Off**.



Press the **OK** button to store the new setting.



Programme edit			
Prog.	Chan.	Name	Lock
1	CH44	ABC	Off
2	CH51	XYZ	Off
3	CH41	FTP	Off
4	CH47	123	Off
5	CH37	456	Off

### Note:

When a programme position is locked, Direct Channel Access using the **C** and numeric buttons on the remote control is not available.

## Copying programme information to a recording device

You can copy programme information to a compatible recording device connected to AV2 / AV3. See page 42 for connection information.

Press the **Download (Blue)** button.

Programme data will now be sent to the recording device(s). This might take a few seconds, depending on the number of stations stored. If the message "Feature not available" appears on the screen, the television is unable to send the programme information to the recording device(s). See the device's instruction book for further information.



DOWNLOAD IN PROGRESS  
PLEASE WAIT  
Programme : 63  
Remote control unavailable

## Tuning menu – Auto setup (Analogue mode)

Auto setup automatically retunes your TV. This feature is useful if, e.g., you move house and wish to retune your TV to receive the local stations.

### In Analogue mode

Press the **MENU** button.

Move to **Setup** menu.

Access **Setup** menu.

Move to **Tuning** Menu.

Access **Tuning** Menu.

Move to **Auto setup**.

Access **Auto setup**.

Press to start **Auto setup**.

MENU

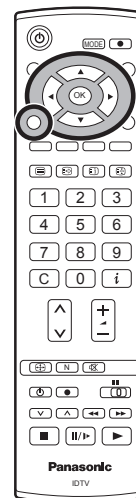

### Notes:

- If you proceed with the next step analogue tuning data will be erased (all stations and their programme positions stored in your TV's memory will be wiped out so the new settings can be stored).
- If you exit the procedure after this point and before **Auto setup** is complete, no station information will be stored. Restart and complete the Auto setup procedure so that the TV is retuned.

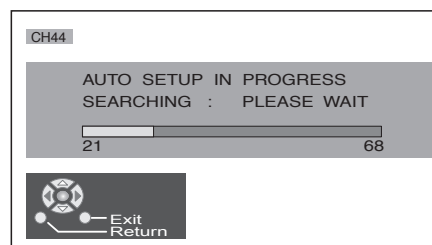
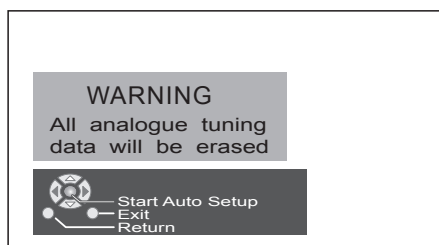

The TV will search for, locate, store and then sort into order your local stations.

If compatible recording device is connected via the AV2 / AV3 terminal, programme data will be sent to the device via Q-Link. See page 34.

Once this operation is completed the TV will display the programme now stored on programme position 1.

## Tuning menu – Manual tuning (Analogue mode)

It is possible to retune individual programme positions:

### In Analogue mode

Press the **MENU** button.

MENU



Move to **Setup menu**.



Access **Setup menu**.



Move to **Tuning Menu**.



Access **Tuning Menu**.



Move to **Manual tuning**.



Access **Manual tuning**.



Select the programme position to be tuned.



Press repeatedly until required station is found.



When the desired station is found, press the **OK** button to store. The programme position will flash.



Press the **EXIT** button at any time to go back to watching TV.

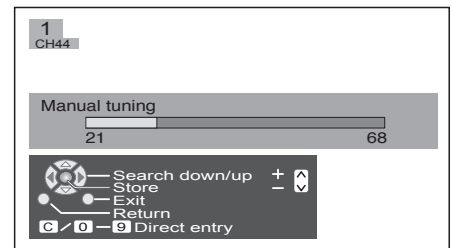
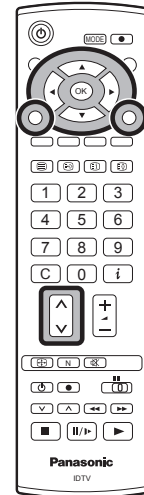

### Note:

If your VCR is connected to this TV by an RF cable only, choose programme position "0" to tune to the VCR signals.

## Manual tuning (via front panel) (Analogue mode)

It is also possible to use the control panel buttons on the front of your TV to tune individual programme positions:

Press the **F** button until **Tuning mode** is reached.

F



Press the **-/V** or **+/\A** button to access **Tuning mode**.



Press the **TV/AV** button to move between **Change programme** and **Search**.



Press the **-/V** or **+/\A** button to change programme position or start search.



When the desired station is found, press the **STR** button to store. The programme position will flash.



Repeat above procedure to tune additional programme positions.

Press the **F** button at any time to go back to watching TV.

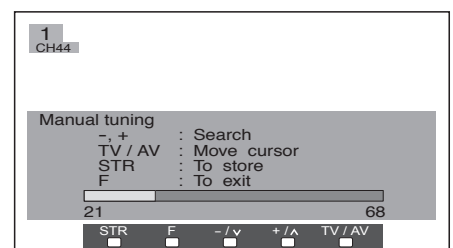
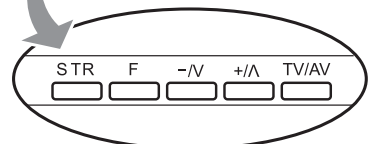
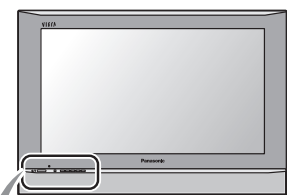

# Owner ID

Owner ID allows you to enter a security code(Owner ID) and personal details into its memory, so that in the unfortunate event of theft it will help the police to trace the owner.

If you wish to check the personal details already entered into the TV (except your PIN number), press the **F** button(Front panel) and hold for 6 seconds(initially the volume level function will appear, as you continue to hold down the **F** button it will disappear again, and the Owner ID information will appear). The details already entered are displayed on screen and will disappear after a few seconds.

If **Owner ID** information was not entered when you switched on your TV for the first time or it is necessary to alter some of the information, **Owner ID** can be re-accessed via the **Setup menu**.

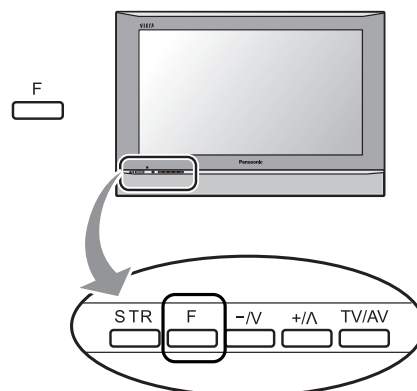

Press the **MENU** button.

Move to **Setup menu**.

Access **Setup menu**.

Move to **Owner ID**.

Access **Owner ID**.

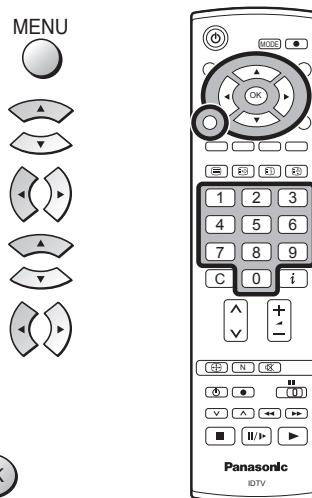

If the **Owner ID** has previously been set, enter the **PIN NUMBER** (using 0 to 9 on the remote control) followed by **OK** to proceed, this will take you to the **NAME** option.

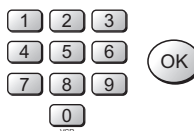

If no **Owner ID** has previously been set, enter the required 4 digit **Owner ID PIN NUMBER** (using 0 to 9 on the remote control).



If a 4 digit **PIN NUMBER** was entered above, you will be taken automatically to the **NAME** line.

Setup menu	
Q-Link	AV2
AV2 out	Monitor
Teletext	FASTEXT
Off timer	Off
Side panel	High
Power save	Off
Power on preference	TV
Tuning Menu	
Owner ID	Access
Shipping condition	

If not, move to the **NAME** line.



Change character.

Select character position.

Repeat above until **NAME**, **HOUSE NUMBER** and **POSTCODE** are entered.

You now have the opportunity to enter your details and help the police crack crime see instruction book

Owner ID	
PIN NUMBER :	* * * *
NAME :	* * * * * * * * * * * * * * * *
HOUSE NO :	* * * * * * * * * * * * * * * *
POSTCODE :	* * * * * * * * * * * * * * * *
0123456789	
<ul style="list-style-type: none"> <li>Change character</li> <li>Select character</li> <li>Store Owner ID</li> <li>Exit</li> <li>Return</li> </ul>	

Press the **OK** button to store the details.  
Press again when you are asked, "Are you sure?".



For future reference,  
write your **PIN NUMBER** here :

\_\_\_\_\_

# Shipping condition

Shipping condition allows you to reset the TV to its original condition, i.e. no channels tuned in. This is useful, for example, if you move to a different area when you will probably want the TV to tune itself to your new local stations.

**Note:**

Owner ID information will not be affected by this function.

This can be done either through the **Shipping condition** menu or through the **Auto setup** menu.

The **Shipping condition** menu will reset all data, except Owner ID information, clearing all DVB and Analogue tuning information and resetting all control levels back to factory settings.

You may need to adjust your VCR or programme position '0' VCR after operating the **Shipping condition** menu.

Press the **MENU** button.

Move to **Setup menu**.

Access **Setup menu**.

Move to **Shipping condition**.

Access **Shipping condition**.

Press the **OK** button to start.

Press again, to confirm, each time that you are asked, "Are you sure?".

Switch the TV off at the mains power switch.

The next time you switch the TV on, Auto setup will begin. DVB and Analogue stations will be located, sorted and stored ready for use. See page 9.

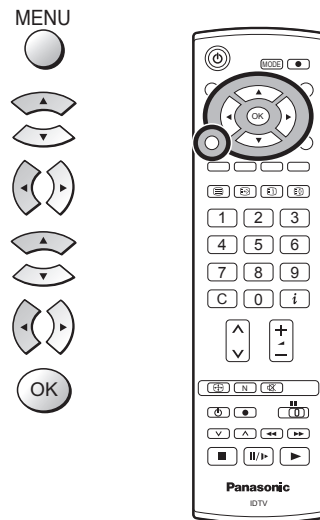

Setup menu	
Q-Link	AV2
AV2 out	Monitor
Teletext	FASTEXT
Off timer	Off
Side panel	High
Power save	Off
Power on preference	TV
Tuning Menu	
Owner ID	
Shipping condition	Access

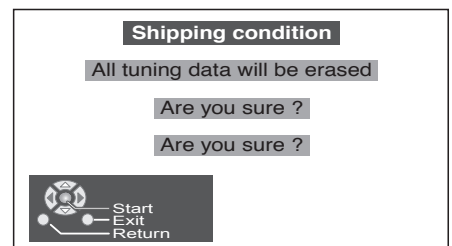

# DVB Setup Menu – overview (DVB mode)

## In DVB mode

Press the **MENU** button.

Move to **Setup menu**.

Access **Setup menu**.

Move to **DVB Setup Menu**.

Access **DVB Setup Menu**.

Move to menu option.

Adjust chosen option or access chosen menu.

Press the **EXIT** button at any time to go back to watching TV.

MENU



EXIT

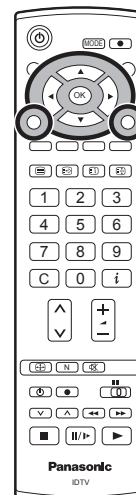

### Timer Programming

Allows you to enter programme times at which the DVB tuner must switch on, ready for recording. See page 24.

### Profile Edit

Allows you to select your favourite programme positions and display them as a list in the TV Guide or Information banner. See page 26.

### Child Lock

You may wish to lock a DVB programme channel to prevent access to it. See page 27.

### DVB Tuning Menu

Provides access to many other DVB Tuning features. See page 28.

### DVB System Setup

Provides access to various specialized DVB options. See page 29.

### Multi Audio

Multi audio, which will only appear when a DVB programme is selected, allows you to select an alternative sound track. The number of options available depends on each broadcast.

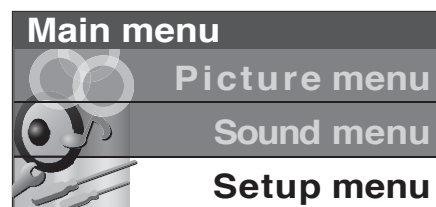

Q-Link	AV2
AV2 out	Monitor
Off timer	Off
Side panel	High
Power save	Off
Power on preference	TV
DVB Setup Menu	Access
Owner ID	
Shipping condition	

Timer Programming	Access
Profile Edit	
Child Lock	
DVB Tuning Menu	
DVB System Setup	
Multi Audio	eng

# Timer programming menu (DVB mode)

For an external recording device to record DVB programmes, the integrated DVB system must be active to provide the signal. The Timer programming menu allows you to choose programmes that you wish to record. At the correct time, the DVB system will switch on and tune to the correct station (even if the TV is in standby mode). If the recording device is compatible with Q-Link or similar technologies (see page 34) and connected to the TV's AV2 / AV3 terminal, you do not need to program the device – the DVB system will control the recording process.

The device must be connected to the TV's AV2 / AV3 terminal using a SCART cable to record DVB programmes.

## In DVB mode

Press the **MENU** button.

Move to **Setup menu**.

Access **Setup menu**.

Move to **DVB Setup Menu**.

Access **DVB Setup Menu**.

Move to **Timer Programming**.

Access **Timer Programming**.

Press the **OK** button to begin programming.

Select the Programme position to be recorded.

Move to the Date field.

Set the Date on which recording is to take place.

The current Date and Time are shown at the top of the menu. See page 25 for further Date options.

Move to the Start time field (◀▶) and set the Start time (▲▼).

Move to the End time field (◀▶) and set the End time (▲▼).

The duration of the recording is shown in the min. column.

The channel position, start and end times can also be input using the numeric buttons on the remote control.

Move to the Subtitles field.

If you wish to record subtitles (if available) select Auto.

Press the **OK** button to store.

Press the **EXIT** button to leave the DVB Timer Programming screen.

### Notes:

- To delete a timer programme, select the recording with the cursor bar and press the **Red** button.
- To edit a previously entered timer programme, select it with the cursor bar and press the **OK** button.
- Timer programmes can also be entered from the TV Guide. See page 32.

Two minutes before the recording is due to start, a reminder will appear on screen:

Press the **OK** button to remove the reminder from the screen.

If you wish to cancel the recording, press the **EXIT** button.

**Note:** The above 2 operations will not be necessary if the TV set is in standby mode.

### Notes:

Six seconds before the recording is due to start the DVB system will tune to the correct station. If you were already watching another DVB station you will see the station change on screen. If you were watching an analogue channel, you will not see the change. You can continue to watch analogue stations while a timer recording is in progress.

If you attempt to switch to another DVB programme position while a timer recording is in progress the message "DVB Tuner Locked" will be displayed. Press the **OK** button to continue recording, or **EXIT** to unlock the programme position. Beware that if you press **EXIT**, timer programming for this DVB position will be immediately deleted.

To immediately cancel a recording that is already in progress, press **GUIDE** then **EXIT**.

You may not be able to cancel recording just before it starts. Use the recording device to cancel it.

MENU

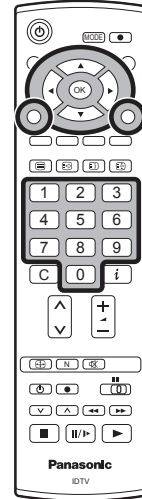

### DVB Setup menu

Timer Programming	Access
Profile Edit	
Child Lock	
DVB Tuning Menu	
DVB System Setup	
Multi Audio	eng

### DVB Timer Programming

Thu 05/08/04 18:49

Pos.	Name	Date	Start	End	min.	Off
1	BBC1	6/8 FR	18:00	20:00	120	Off
3	ITV1	7/8 SA	21:30	22:30	60	Off
40	BBC News 24	8/8 SU	15:30	16:45	75	Off
33	Boomerang	9/8 MO	23:10	24:30	80	Off
92	Kerrang!	10/8 TU	20:00	22:00	120	Off
46	The Community Channel	11/8 WE	19:30	21:30	120	Off
18	The Hits	12/8 TH	16:00	18:00	120	Off
5	Five	13/8 FR	19:00	20:00	60	Off

Select timer

Edit timer

Exit

Return

Delete

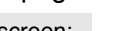
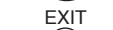



# Timer programming menu (DVB mode)

## Daily and Weekly Timer Programmes

While in the Date field of the DVB Timer programming menu, you can select various options to determine how often a recording should be made. Press the down cursor button repeatedly to access the following options:



### Daily SU-SA

The recording device will record at the same time every day.

### Daily MO-SA

The recording device will record at the same time each day from Monday to Saturday.

### Daily MO-FR

The recording device will record at the same time each day from Monday to Friday.

### Weekly SA, FR, TH, WE, TU, MO or SU

The recording device will record at the same time on the same day each week.

Pos.	Name	Date	Start	End	min.	□
1	BBC1	6/8 FR	18:00	20:00	120	Off
3	ITV1	Weekly TH	21:30	22:30	60	Off
40	BBC News 24	8/8 SU	15:30	16:45	75	Off
33	Boomerang	9/8 MO	23:10	24:30	80	Off
92	Kerrang!	10/8 TU	20:00	22:00	120	Off
46	The Community Channel	11/8 WE	19:30	21:30	120	Off
18	The Hits	12/8 TH	16:00	18:00	120	Off
5	Five	13/8 FR	19:00	20:00	60	Off

Navigation options: Change date, Select, Store timer, Exit, Return, Delete

### Notes:

- If new timer programme data overlaps any part of an existing timer programme, a warning message will appear.
- The TV set must be "On" or in "Standby" mode for the DVB programme signals to be output to the external recording device.

## Encrypted Programmes

In the future, some DVB programmes may be "encrypted". This means that the DVB programme cannot be viewed or recorded unless you have the correct Common Interface module to decode the programme.

When you attempt to view or set Timer recording of an encrypted programme and you have no CI module inserted, a message will appear on screen.

# Profile Edit menu (DVB mode)

The Profile Edit menu allows you to select your favourite programme positions and display them as a list in the TV Guide or Information banner, to allow quick and easy access to the programs you watch most often. You can make the 4 kinds of the list.

## In DVB mode

Press the **MENU** button.

MENU



Move to **Setup menu**.



Access **Setup menu**.



Move to **DVB Setup Menu**.



Access **DVB Setup Menu**.



Move to **Profile Edit**.



Access **Profile Edit**.

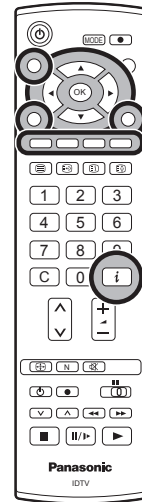

## Add a channel to the Profile list

Move to the programme position which you wish to add to the profile list.



Press the **Red** button repeatedly to cycle through the channel categories.



Press the **Green** button repeatedly to cycle through the profiles.

Press the **Yellow** button to add a channel to the profile list.

Press the **Blue** button to add all the channels to the profile list.

Press the **OK** button to store your Profile list.



## Edit the Profile list

When the profile list is highlighted

Press the **Red** button to edit the profile name.



Press the **Green** button to move the channel.

Press the **Yellow** button to delete the channel.

Press the **Blue** button to delete the all channels.

Press the **MENU** button to return to the DVB Setup Menu.

MENU



Press the **EXIT** button at any time to exit Profile Edit.

EXIT



A list of favourites can be accessed by pressing the **GUIDE** button or the **i** button.

GUIDE



See page 32.



DVB Setup menu	
Timer Programming	
Profile Edit	Access
Child Lock	
DVB Tuning Menu	
DVB System Setup	
Multi Audio	eng

Profile Editor	
All Services	Profile 1
1 BBC ONE Wales	
2 BBC 2W	
7 BBC THREE	
10 BBC FOUR	
30 CBBC Channel	
31 CBeebies	
40 BBC NEWS 24	

Select programme

Store  
Exit  
Return

Select Category    Select Profile    Add    Add All

# Child Lock menu (DVB mode)

You may wish to lock a DVB programme channel to prevent access to it.

**Note:**

The data of the PIN number and locked channel will be erased by operating the Shipping condition.

**In DVB mode**

Press the **MENU** button.

Move to **Setup menu**.

Access **Setup menu**.

Move to **DVB Setup Menu**.

Access **DVB Setup Menu**.

Move to **Child Lock**.

Access **Child Lock**.

MENU

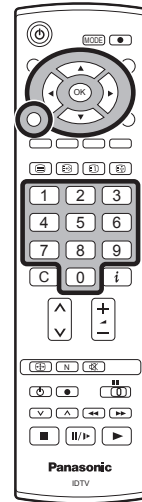

When entering Child Lock menu for the first time, new PIN number setting screen is displayed.

Create a 4-digit password.

Enter the password again to confirm.

From the second time, enter a password once to display Child Lock screen.

Move to **Child Lock Service List**.

Access **Child Lock Service List**.

Select the channel you want to lock and then press the **OK** button to lock. Press again to unlock.

Press the **Yellow** button to lock all channels.

Press the **Blue** button to unlock all channels.

The PIN number is required when you wish to watch a locked channel. If the unit is turned off it will be necessary to input the PIN number again to access any locked channels.

**Change the PIN number**

In Child Lock menu

Move to **Change PIN**.

Access **Change PIN**.

Create a 4-digit new password.

Enter the password again to confirm.

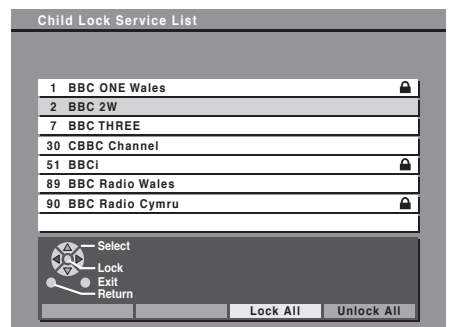
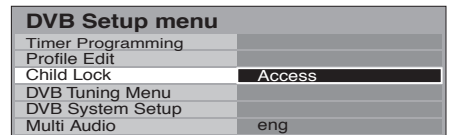
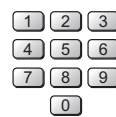
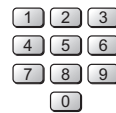

# DVB Tuning Menu (DVB mode)

DVB Tuning Menu provides access to DVB Tuning features.

## In DVB mode

- Press the **MENU** button.
- Move to **Setup menu**.
- Access **Setup menu**.
- Move to **DVB Setup Menu**.
- Access **DVB Setup Menu**.
- Move to **DVB Tuning Menu**.
- Access **DVB Tuning Menu**.
- Move to menu option.
- Adjust chosen option or access chosen menu.
- Press the **EXIT** button at any time to go back to watching TV.

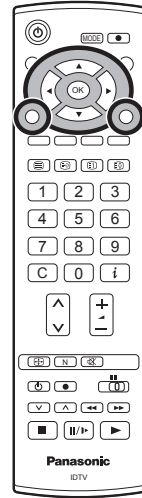
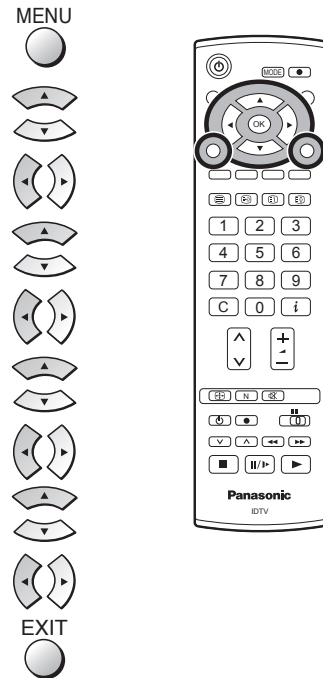

**DVB Auto Setup** Automatically retunes your TV. DVB stations will be located, sorted into order and stored. DVB tuning data will be erased. If you set the Child Lock PIN number, the number is required before DVB Auto Setup.

DVB Setup menu	
Timer Programming	
Profile Edit	
Child Lock	
DVB Tuning Menu	Access
DVB System Setup	
Multi Audio	eng

**Add New Service** You can add new DVB stations while retaining existing tuning data. When the New Services Found message appears new DVB stations are available to add to your existing DVB channel list.

DVB Tuning Menu	
DVB Auto Setup	Access
Add New Service	
New Service Message	On
Signal Quality	

**New Service Message** This TV continually scans for updated DVB services and notifies you of any changes. Set to On to receive notification. Set to Off if you do not wish to be informed of any updates.

DVB Auto Setup					
Please Wait !					
Prog.	Channel	Service Name	NetID.	TS ID.	Quality
4	30	BBC NEWS 24	12302	4158	9
5	30	BBCI	12302	4158	9
6	30	CBBC Channel	12302	4158	9
7	30	BBC Radio Wales	12302	4158	9
8	30	BBC Radio Cymru	12302	4158	9

This will take about 3 mins.

**Signal Quality** The signal quality function displays an indication of signal quality for each DVB programme position. The DVB system requires a good quality signal to provide the best picture. When viewing analogue pictures, interference such as signal reflection from nearby buildings or mountains causes 'ghosting', but still provides a viewable picture. For the DVB system, interference such as this can disrupt the flow of data causing the picture to appear to be made up of large blocks, or to freeze intermittently. If the picture disappears completely, this could mean that signal quality is very poor. If this happens often, you may need to improve your aerial system to provide a better signal.

Add New Services					
Please Wait !					
Prog.	Channel	Service Name	NetID.	TS ID.	Quality

This will take about 3 mins.

New Service Message On

**New DVB Service Found!**  
Press OK to add new service  
Press EXIT to Ignore

# DVB System Setup (DVB mode)

The DVB System Setup menu provides access to DVB specific options.

## In DVB mode

Press the **MENU** button.

Move to **Setup menu**.

Access **Setup menu**.

Move to **DVB Setup Menu**.

Access **DVB Setup Menu**.

Move to **DVB System Setup**.

Access **DVB System Setup**.

Move to menu option.

Adjust chosen option or access chosen menu.

Press the **EXIT** button at any time to go back to watching TV.

Pressing the **OK** button after having adjusted some features will store the setting as the default (replacing the factory setting).

MENU



EXIT



OK

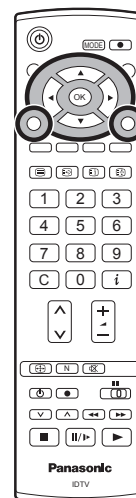

**Common Interface Module** The Common Interface Module menu provides access to functions contained on a Common Interface Module inserted into the CI slot, located at the rear of the TV. See page 30.

**Preferred Subtitles** This option allows you to select the language in which subtitles should appear (if available) when the **STTL** button is pressed.

**System Update** This menu allows you to download new software to the television. See page 31.

**Display Timeout** This option allows you to set how long the information banner stays on screen. Select from 0 (No display) to 10 seconds in 1 second increments. See page 33.

DVB Setup menu	
Timer Programming	
Profile Edit	
Child Lock	
DVB Tuning Menu	
DVB System Setup	Access
Multi Audio	eng

DVB System Setup	
Common Interface Module	Access
Preferred Subtitles	English
System Update	
Display Timeout	3 seconds

# Common Interface Module menu (DVB mode)

The Common Interface Module menu provides access to software contained on Common Interface (CI) Modules. These can be inserted in the "CI" slot located at the rear of the TV.

## IMPORTANT NOTES:

- Switch off the TV using the front panel switch before inserting or removing a module.
- If you are installing a TV software update, please follow the dedicated instructions supplied with the module.
- Insert / remove a module straightly to the CI slot.

## Insert the CI module:

Some Common Interface Modules may be a two piece design consisting of a card reader together with the viewing card. When using this design of card, first insert the card reader firmly into the CI slot on the TV. Secondly, insert the viewing card into the reader.

Switch on the TV.

## In DVB mode

Press the **MENU** button.

Move to **Setup menu**.

Access **Setup menu**.

Move to **DVB Setup menu**.

Access **DVB Setup menu**.

Move to **DVB System Setup**.

Access **DVB System Setup**.

Move to **Common Interface Module**.

Access **Common Interface Module**.

Access the module.

If no module is inserted the message "No Module Inserted" will be displayed.

(If you have inserted a module, check that it is fully inserted.)

The features that now appear on screen are dependent on the contents of the selected Common Interface Module.

Refer to the instructions supplied with the card or contact the vendor.

In all cases, it is possible to navigate the pages using buttons on the remote control, but because the commands available must apply to all manufacturers of DVB equipment, some on screen commands may not correspond exactly to the remote control buttons.

For example:

For the on screen command 'select' or 'go', use the **OK** button.

If you see the ◀▶▼▲ symbols, use the cursor keys.

If you see a line of key words displayed in red, green, yellow and blue, use the coloured buttons to operate the functions.

The **EXIT** button should always allow you to exit the CI software.

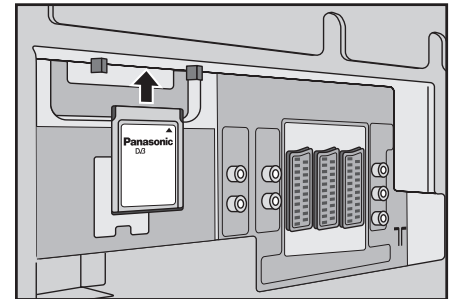

MENU

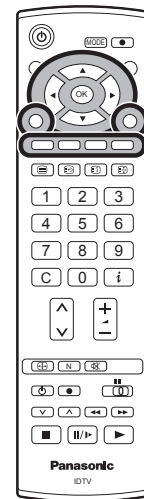

DVB System Setup	
Common Interface Module	Access
Preferred Subtitles	English
System Update	
Display Timeout	3 seconds

Common Interface	
Slot 1: No module inserted	Access



EXIT



# System Update menu (DVB mode)

From time to time new versions of software will become available to enhance the performance and features of this TV.

## Auto Update Search in Standby (Overnight)

During the night time, this TV will automatically search for any new available software being broadcast. If a new software version is found, the unit will automatically download and install this new version. At the end of this process the unit will reset. Auto Update Search in Standby will occur at 03:00 or 05:00 every day.

### In DVB mode

Press the **MENU** button.

Move to **Setup menu**.

Access **Setup menu**.

Move to **DVB Setup Menu**.

Access **DVB Setup Menu**.

Move to **DVB System Setup**.

Access **DVB System Setup**.

Move to **System Update**.

Access **System Update**.

Move to **Auto Update Search in Standby**.

Choose between **On** or **Off**.

MENU

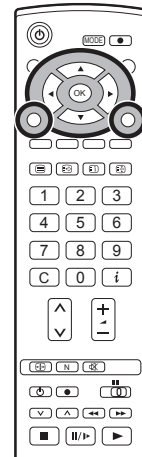

### DVB System Setup

Common Interface Module	English
Preferred Subtitles	English
System Update	Access
Display Timeout	3 seconds

Set to **On** to search for new software and update automatically in Standby mode. This does not work when the unit off.

If there is a new version software being broadcast, the TV will download this automatically.

Auto Update Search in Standby will only occur if:

- The unit is in Standby mode
- No timer recording is set for 03:00 or 05:00(GMT)
- No recording is being made at 03:00 or 05:00(GMT)

Set to **Off** if you do not want new software to be automatically downloaded. In this case a new software banner will appear when the TV set is switched on and tuned to a BBC channel, if new software is being broadcast. Press the **OK** button to download the new version.

The TV will begin download of the new software version. This can take up to 15 minutes.

Press the **EXIT** button to exit without download.

New version 1.00 found.  
Do you really want to update the software and reboot the system?

**To ensure that your TV automatically updates when new software is available, please place the TV in Standby last thing at night when you have finished viewing.**

## System Update Search Now (Manual Download)

To manually check if a new software version is available, select **System Update Search Now** in System Update menu and press the **OK** button.

The TV will search for new versions of software and indicate whether a newer version is available or not. This search process may take a few minutes.

If a newer software version is found, an on screen message will inform the user that it is available. The user is given the chance to download this version.

Press the **OK** button to download the new version.

The TV will begin download of the new software version. This can take up to 15 minutes.

Press the **EXIT** button to exit without download.

**Please do not switch off the TV or press any buttons while this download is in progress. The TV will reset after the software download is complete.**

Press the **MENU** button to return to DVB System Setup menu.

Press the **EXIT** button to exit from menus.

## Software Licence

Access to show the information of the Software Licence.

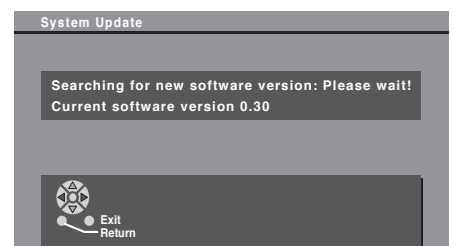



# TV Guide - Electronic Programme Guide (EPG) (DVB mode)

The DVB TV Guide displays the current programmes being transmitted, and forthcoming programmes on each DVB channel, up to about one week ahead (If broadcasters transmit the programmes information). When you are using the TV for the first time or you have not used it for about one week, it takes thirty to forty minutes after turning the TV on to display the TV Guide fully.

Press the **GUIDE** button.

Choose from Landscape or Portrait display style by pressing the **GUIDE** button repeatedly.

Press the **Red** button to move the EPG listing to the previous day. Press the **Green** button to move the EPG listing to next day. Press the **Yellow** button to view a list of Categories.

The Favourites list can be customised using the Profile Edit menu. See page 26.

Press the **Blue** button to view a list of Prog. type.

EPG listing can be set to display by Category or Programme Type. For example press the **Yellow** button and select 'Free TV', 'Radio' services or 'Profile 1' by pressing the up or down cursor buttons. Press the **OK** button to view a list of the selected category.

To view any of the current DVB programmes, select it with the cursor buttons and press the **OK** button.

GUIDE



Landscape

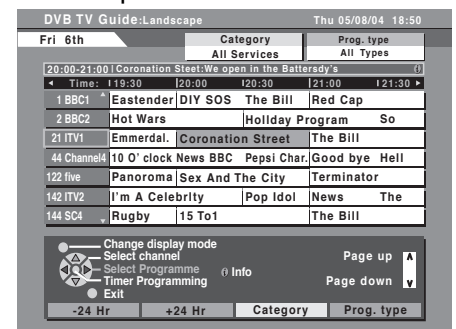

Portrait

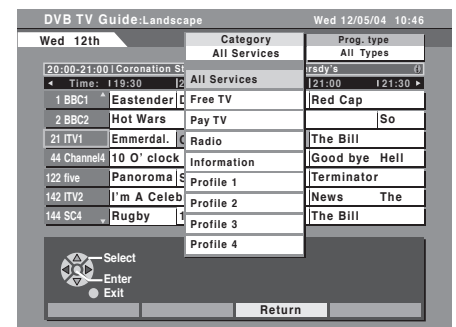
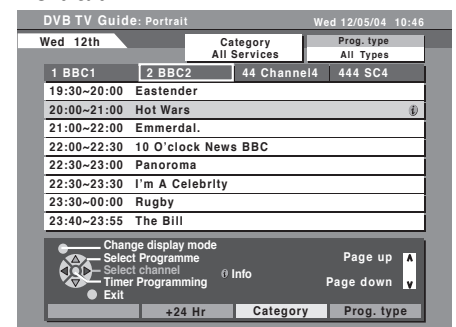

## Information and Timer Programming (ex. Landscape)

You can view further information about the selected programme:

Select the programme for which you require further information using the cursor buttons.

Press the **i** button to display the information.

Press the **i** button again to return to the list of programmes.



When you select a future programme from the EPG listing, press the **OK** button to set timer programming for recording on a Q-Link compatible recorder. See page 24, 25, 34.

Press the **MENU** button to return to the TV Guide.

Press the **EXIT** button to exit the Guide.



MENU



EXIT





# Information banner

## In DVB mode

Information banner will appear when changing channel, or pressing the **i** (Information) button. The banner gives the user information about the channel and programme currently being viewed. The banner will time out and disappear from the screen after a set time period, this time period can be set in the DVB System Setup menu. See page 29.

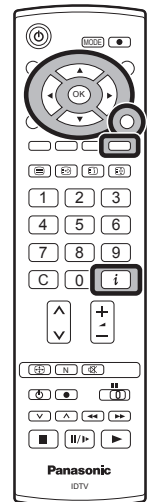
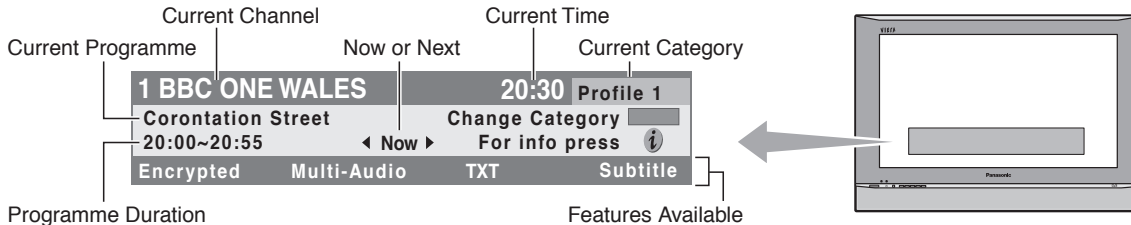

Press the left or right cursor button while banner is displayed to switch between **Now** and **Next**.

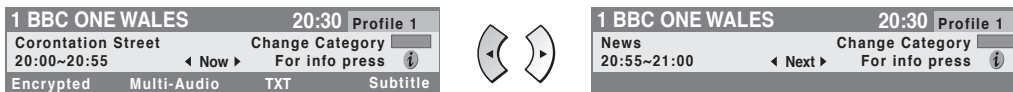

This switches between the information for the current Programme being shown (**Now**) and the next Programme to be shown (**Next**).

Press the up or down cursor button to step through the banner information for all channels. Press the **OK** button to view a channel. Now and Next can also be used in this mode.



While the banner appears

Press the **i** button to display an extended banner showing any information available on the current selected programme.

Press the **i** button while in extended banner mode to return to normal banner view.

To clear the banner from the screen while in extended banner mode, press the **EXIT** button.



## Viewing Category

Press the **Blue** button while in the banner to scroll through available categories.

For example:

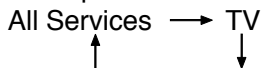

All Services : All available Services

TV : TV channels only

Radio : Radio channels only

User Profiles ← Radio User Profiles : 4 individual Profiles set up by user (see page 26)

Press the **EXIT** button to exit the banner at any time.



## In Analogue mode

Pressing the **i** (Information) button will display the analogue channel information for a few seconds. This will then be timed out to display just the programme position number near the top left corner of the screen.

To remove this programme position number, press the **i** (Information) button again.



# Subtitles ON / OFF (DVB mode)

## In DVB mode

Press the **STTL** button to switch Subtitles ON.

Subtitles will appear (if available) by the language you select in Preferred Subtitles in DVB System Setup menu. See page 29.

Press again to switch Subtitles OFF.

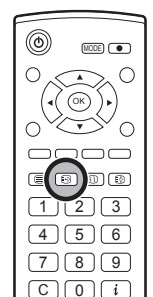

# Q-Link

## Q-Link allows the television to communicate with a compatible VCR or DVD Recorder.

For Q-Link communication to work, the TV must be connected to a recording device with the “Q-Link”, “NEXTVIEWLINK”, “DATA LOGIC”, “Easy Link”, “Megalogic” or “SMARTLINK” logo using a “fully wired” Scart cable between the AV2 / AV3 terminal of the television and the appropriate terminal on your VCR or DVD Recorder. See page 15 for details of Q-Link terminal setup. This television does not support any other types of recording control signal.

For connection to the appropriate Scart terminal on the recording device, refer to the device’s instruction book.

### When using a “NEXTVIEWLINK” device the main features possible are the following :

#### Preset Download

This allows the programme order from the TV to be downloaded to the recording device, helping to ensure that correct recordings are made; there are several ways to perform this operation :

1. During installation as explained in the “Quick Start Guide” on page 8-10.
2. When Auto setup is started from within the Tuning menu. See page 16.
3. Preset download started from the recording device, refer to the device’s instruction book.

Because a recording device cannot tune to DVB stations, only the analogue programme positions are downloaded to the device.

#### What You See Is What You Record (DIRECT TV RECORDING)

This will allow the immediate recording of the programme currently shown on the TV, by the recording device attached to the Scart terminal, which can be chosen using “Q-Link”. See page 15.

Press the **DIRECT TV REC** button.



If the recording device is in Standby mode with usable recording media inserted, it will automatically switch on when you press the **DIRECT TV REC** button.

If a “Q-Link” device is connected, a message will appear on the TV screen showing what is being recorded, or if it is not possible to record. Some “Q-Link” compatible devices will only display the message when on the VCR programme position(0) or in AV mode. Refer to the device’s instruction book.

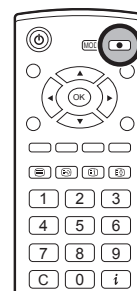

### Recording in progress

The recording device is recording the programme signal from its own tuner. If you wish you can switch off the TV and leave the device recording in the normal way.

#### Recording DVB stations

If you press the **DIRECT TV REC** button while watching a DVB station, the recording device will automatically switch to its AV input to record the DVB signal from the TV (via the SCART cable), and the DVB programme position will be locked. If you attempt to select another DVB programme position while recording, you will see the message “DVB Tuner Locked”. Press the **OK** button to clear the message, or the **EXIT** button to unlock the programme. Beware that if you press **EXIT**, the DVB programme will be unlocked – switching to another DVB programme will spoil your intended recording. Stop the recording manually.

### Additionally, when using a “Q-Link” device the following main features are possible:

The following features are only available from the device connected to the Scart terminal selected using “Q-Link”. See page 15.

#### TV / Recording device Auto Power On

If you insert pre-recorded media into the recording device and press the Play button whilst the TV is in Standby mode, the TV will automatically switch on and select the correct AV input so that you can view the content.

#### Recording device Auto Power Standby

When the TV is switched into Standby mode, the recording device will also switch into Standby mode if there is no media inserted, or if there is media inserted and the device is in Rewind or Stop mode. If a VCR is rewinding a tape, it will not switch into Standby mode until rewinding has finished.

#### Recording device Image View On

If the TV is in Standby mode and the recording device sends a menu to be displayed on the TV screen (e.g., Main menu), the TV will automatically switch On and the menu will be displayed.

This TV will also communicate with other recording device’s that bear the following logos :

- “DATA LOGIC” (a trademark of Metz Corporation)
- “Megalogic” (a trademark of Grundig Corporation)
- “Easy Link” (a trademark of Philips Corporation)
- “SMARTLINK” (a trademark of Sony Corporation)

#### Important Note:

Some recording devices may not support all or some of the above functions. Refer to the instruction book for the device. If Q-Link functions do not work, check the connection and ensure that the scart lead is a fully-wired type.

# Aspect Controls

The Widescreen TV will allow you to enjoy viewing the picture at its optimum size and aspect, including widescreen cinema format pictures.

Press the **ASPECT** button repeatedly to move through the seven aspect options:

**Panasonic Auto, 16:9, 14:9, 4:3, Zoom1, Zoom2 and Zoom3**

**OR**

Press the **ASPECT** button. Whilst the on screen selector keys are displayed, use the **Red** or **Green** buttons to move in either direction through the seven aspect options.

## Note:

This is not available for 720p and 1080i component signals input. Aspect is fixed to 16:9.

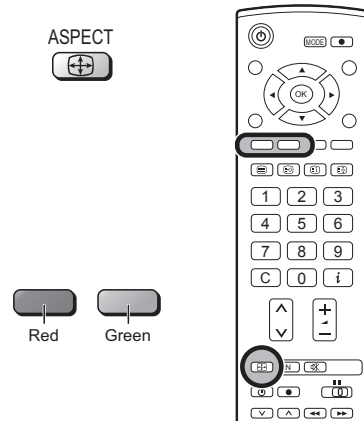

## Panasonic Auto

**Panasonic Auto** determines the best aspect ratio to use to fill your screen. It does this using a four step process to determine if the picture being viewed is a widescreen picture.

If **Panasonic Auto** detects a widescreen signal it switches into the appropriate widescreen mode. If **Panasonic Auto** does not detect a widescreen signal then this advanced TV set enhances the picture for optimum viewing pleasure.

The text shown on the screen indicates how **Panasonic Auto** determined which ratio to use:

**Panasonic Auto** switches to the appropriate widescreen ratio.

“Panasonic Auto” appears in the top left of the screen if black stripes above and below the picture are detected.

**Panasonic Auto** chooses the best ratio and expands the picture to fill the screen. This process can take several minutes, depending on the darkness of the picture.

You may prefer to manually select one of the other aspect options available to view the picture.

## Notes:

- If, in Panasonic Auto mode, you experience problems with the screen display size when playing back widescreen format recordings from your VCR then it is possible that the tracking control of your VCR requires adjustment (your VCR instruction book will contain adjustment details).
- The widescreen aspect ratios of different films and programmes can vary.  
If these are wider than a standard 16:9 aspect picture then a black band may be visible at the top and bottom of the screen.
- “WIDE” will appear in the top left corner of the screen and picture aspect changes accordingly in any aspect modes, if a widescreen identification signal (WSS) is detected or a control signal is found through a Scart terminal.
- Automatic aspect ratio adjustment by WSS signal is not available for progressive and high definition component signals input.



“WIDE” appears in the top left of the screen, **Panasonic Auto** switches to the appropriate 16:9 or 14:9 widescreen ratio.



“Panasonic Auto” appears in the top left of the screen. The best ratio is chosen and the picture expanded to fill the screen.

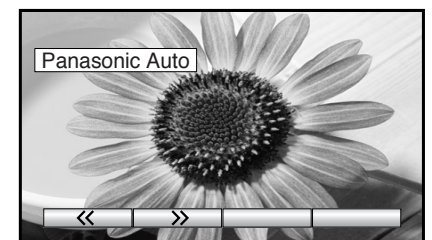

Press the **ASPECT** button, then use the **Red** or **Green** buttons to move in either direction through the seven aspect options.

# Aspect Controls

## 16 : 9

**16:9** will display a true 16:9 (anamorphic) picture with no aspect distortions.

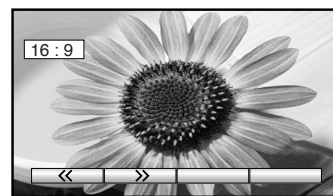

16 : 9

## 14 : 9

**14:9** will display a 14:9 picture at its standard 14:9 size without any stretching.

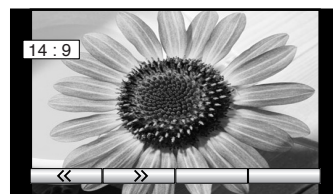

14 : 9

## 4 : 3

**4:3** will display a 4:3 picture at its standard 4:3 size with no aspect distortions.



4 : 3

## Zoom1

**Zoom1** will display 16:9 letterbox or 4:3 pictures with no aspect distortions.

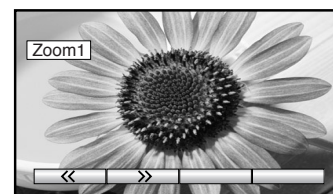

Zoom1

## Zoom2

**Zoom2** will display 16:9 anamorphic letterbox pictures as a full screen display with no aspect distortions.



Zoom2

## Zoom3

**Zoom3** will display 21:9 letterbox pictures as a full screen display with no aspect distortions.

**16:9** will display the picture at its maximum size but with slight stretching.

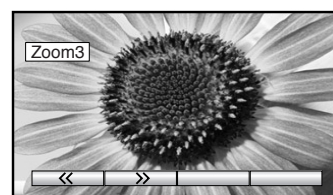

Zoom3

# Still









Press the **HOLD** button to freeze the picture.  
Press again to return to watching the current programme.



# VCR / DVD operation

The Remote Control is capable of operating some functions of selected Panasonic VCRs and DVD (Digital Versatile Disc) equipment. Some VCR and DVD equipment have different functions, so to ensure compatibility please refer to the equipment's instruction book or consult your dealer for details.



	<p><b>Standby</b> Press to switch the VCR, DVD or DVD recorder to Standby mode. Press again to switch back on.</p>
	<p><b>VCR / DVD switch</b> Use this switch to select whether controls operate the DVD equipment or VCR.</p>
	<p><b>Play</b> Press to playback the tape or DVD.</p>
	<p><b>Stop</b> Press to stop the tape or DVD.</p>
	<p><b>Skip / Fast Forward / Cue</b> VCR: Press to fast forward the tape. In Play mode, press to view the picture rapidly forward (Cue). When fast forwarding the tape, the picture noise may occur. DVD: Press to skip to the next track or title. Press and hold to search forward.</p>
	<p><b>Skip / Rewind / Review</b> VCR: Press to rewind the tape. In Play mode, press to view the picture rapidly in reverse (Review). DVD: Press to skip to the previous track or title. Press and hold to search backward.</p>
	<p><b>Pause / Still</b> Press in Play mode, the picture will pause. Press again to restart play. DVD: Press and hold for slow-motion play.</p>
	<p><b>Programme Up / Down</b> Press to increase or decrease the programme position by one.</p>
	<p><b>Record</b> Press this button to start recording.</p>



# Teletext operation

## In Analogue mode

- Teletext features may vary depending on the Broadcasting Companies and is only available if the channel selected is transmitting Teletext.
- Pressing the **MENU** button whilst in Teletext operation will display the contrast function with a cyan bar, press the left and right cursor buttons to alter the setting as required.
- Pressing the **MENU** button whilst in Teletext operation will display special function options at the bottom of the screen.
- Pressing the **Volume up / down** button whilst in Teletext operation will display the volume function with a green bar, press the volume up / down button to alter the setting as required.

## What is List mode ?

In List mode, four differently coloured page numbers are situated at the bottom of the screen. Each of these numbers can be altered and stored in the TV's memory.

## What is FASTEXT mode?

In FASTEXT mode, four differently coloured subjects are situated at the bottom of the display. To access more information about one of these subjects, press the appropriately coloured button. This facility enables fast access to information on the subjects shown.



### TV / Teletext mode

Press the **TEXT** button repeatedly to switch the mode.

Each time you press the button: Teletext mode  $\longrightarrow$  Picture and text mode  
 $\longleftarrow$  Current TV programme  $\longleftarrow$  (see page 40)

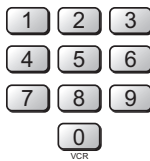

### Page Selection

Pages can be selected in two ways :

- Press the Up / Down cursor buttons to increase or decrease the page number by one.
- By entering the page number, using 0 - 9 on the remote control.



### Full / Top / Bottom

Press the **MENU** button to display special functions, followed by the **Green** button.  
Press the **Green** button again to expand the BOTTOM half.  
Press again to return to normal (FULL) size.



### Reveal

Press the **MENU** button to display special functions, followed by the **Red** button to reveal hidden words e.g. quiz page answers. Press again to hide.



### Red / Green / Yellow / Blue buttons

In FASTEXT mode they correspond to the differently coloured subjects.  
In List mode they correspond to the differently coloured page numbers.

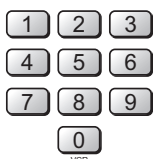

### List Store

In List mode the four page numbers can be altered (programme positions 1 - 25 only).  
To do this, press one of the four coloured buttons and enter the new page number.  
Press and hold the **OK** button, the page numbers will change to white indicating that the page is stored.



### HOLD

To hold the Teletext page when viewing multi-page information.  
Press again to return to automatic page update.

# Teletext operation

It is not possible to change the programme position when in News flash, Update or Sub Coded Page Access operation.

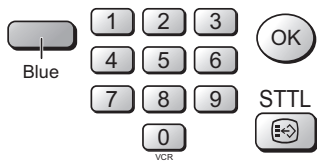

## Favourite Page (F.P.)

Stores a favourite page in memory for instant recall. To store such a page, the TV must be in List mode, and the programme position must be from 1 - 25.

Press the **Blue** button, select the page number, then press and hold the **OK** button. The page number is now stored.

Press **STTL** to recall this page.

## Update Display

Press the **MENU** button to display special functions, followed by the **Yellow** button to view the TV picture whilst searching for a Teletext page (this is not necessary in Picture and text mode, as the picture is displayed on the left of the screen). When found, the screen will display the page number at the top left. Press the **Yellow** button to view the page.

Press the **TEXT** button again to return to normal TV operation.

## News Flash

When a news flash page has been selected, press the **MENU**, **Yellow** buttons, to view the TV picture. When an update is received, the page number will be displayed on screen.

Press the **Yellow** button to display the News Flash.

Press the **TEXT** button to return to normal TV operation.

## Update

Press the **MENU**, **Yellow** buttons to see the update of information on certain pages.

When an update is received, the page number will be displayed at the top left of the screen.

Press the **Yellow** button to view the page.

Press the **TEXT** button to return to normal TV operation.



## Accessing sub pages

When Teletext information exceeds one page, it may take some time for the automatic changing of the sub pages to reach the sub page you require. As each sub page is found its number is displayed at the top of the page so that you may select it; as more sub pages are picked up, the display at the top of the page changes, so that you are always offered the most recently transmitted selection of sub pages.

In Teletext operation, use the following procedure to access sub pages:

If the sub page you want to look at is not yet available, press the **MENU** button (to display special functions) followed by the **Yellow** button to view the TV picture whilst waiting for more sub pages to be found. The sub pages found will be displayed across the top of the screen.

When the sub page you are waiting for is available press the **Yellow** button to return to viewing the Teletext pages, then use the left and right cursor buttons to select the sub page of your choice.

The maximum number for sub page that can be entered is restricted to 79 by broadcasters.

## Notes:

- If you do not want to display the on screen selector keys on the TV picture whilst waiting for a sub page to be found, press the **MENU** button to clear the keys from the screen. Press again to redisplay the keys.
- If you have cleared the special function keys from the screen and then used the left and right cursor buttons to select a sub page, whilst still viewing the TV picture, you must press the **MENU** button then the **Yellow** button to display the Teletext page again.
- If the top of the page indicates that sub pages are being transmitted but the page displayed never changes, then the 'sub page number' is there to show the page contents have been updated, there are no sub pages.

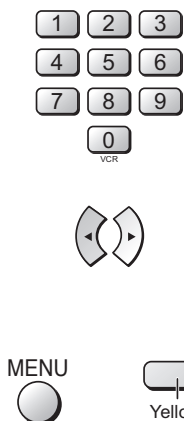

# Teletext operation



Alternatively, if you know which sub page you require, press the **MENU** button (to display special functions) followed by the **Blue** button; T\*\*\*\* will be displayed where the page number is normally found.

Enter desired sub page number before the T\*\*\*\* disappears.

e.g., to select page 6 enter 0, 0, 0 and 6.

Press the **Yellow** button to view the TV picture whilst waiting for more sub pages to be found. The sub pages found will be displayed across the top of the screen.

When the page is available, press the **Yellow** button to view the page. Regardless of how many pages are found, pressing the **Yellow** button will take you to the sub page which you requested.

Press the **TEXT** button to return to normal TV operation.

---

## INDEX

### When in FASTEXT operation



Press the **INDEX** button to return to the main index page.

Depending on the way information is transmitted, this may have to be pressed more than once to return to the main index page.

---

## Picture and text

Press the **TEXT** button to enter Picture and text mode.



Picture and text mode lets you see the current programme and a page of teletext side by side. Whilst using this feature, the remote control affects the teletext page; if you wish to make changes to the programme viewed press the **TEXT** button to return to watching the programme on its own then make the desired changes.

---

## In DVB mode

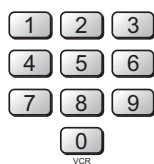

### DVB teletext services

DVB teletext services differ greatly from analogue teletext. When you switch to a DVB teletext service, the images you see can contain graphics and text, laid out and controlled in a manner decided by the broadcaster. In all cases, it is possible to navigate the pages using buttons on the remote control, but because the commands available must apply to all manufacturers of DVB equipment, some on screen commands may not correspond exactly to the remote control buttons.

For example:

- For the on screen command 'select' or 'go', use the **OK** button.
- If you see the ◀▶▼▲ symbols, use the appropriate CURSOR keys.
- If you see a line of key words displayed in red, green, yellow and blue, use the coloured multifunction buttons to operate the functions.
- For numbered options, use the numeric keypad.
- The **TEXT** button should allow you to exit the teletext system. Alternatively, press the **Channel up / down** buttons to select another channel.

As soon as you switch to a DVB channel with links to a teletext service, software is downloaded in the background to enable the teletext function. This means that when switching to a DVB channel, you should wait for approximately 5 seconds before pressing the **TEXT** button – this will allow the software to download. If you press the **TEXT** button before download is complete, there will be a short delay before the text screen is displayed.

While navigating DVB teletext, you will find there is a short delay when moving between pages while the page downloads.

There is often a prompt shown somewhere on the page (for example "Loading") to let you know what is happening.



# Audio / video connections

It is possible to connect a variety of additional equipment to this TV. The following pages detail how to connect external equipment to the rear of the TV.

Once your equipment is connected, use the following procedure to view the input:

While viewing a TV channel

Press the **TV/AV** button.

Whilst the on screen selector keys are displayed, press coloured buttons to select the AV source you wish to view.

- Red** button : AV1 Scart terminal
- Green** button : AV2 Video, S-Video Scart terminal
- Yellow** button : AV3 Video, S-Video Scart terminal
- Blue** button : Component terminals

The on screen selector keys will disappear after a few seconds. If you want to select an input when the keys are not shown, press any one of the coloured buttons and the keys will reappear.

## Notes:

- You can also select an AV source using the **TV/AV** button on the front panel of the TV.  
Press the **TV/AV** button repeatedly until you reach the AV source you wish to view.
- When in **AV mode** a reduced number of options are available in the **Sound** and **Setup** menus (e.g., in the Setup menu there is no **Tuning Menu** option).

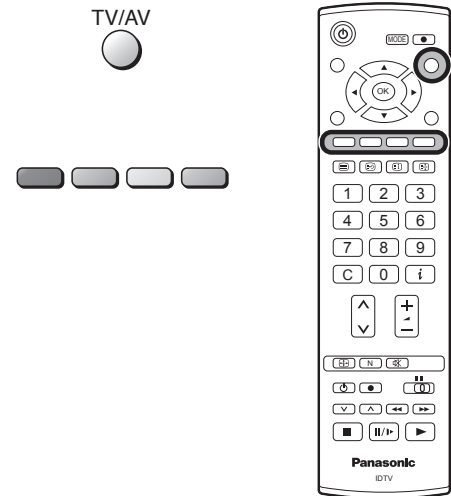

# Audio / video connections

## How to connect the Audio Output terminals

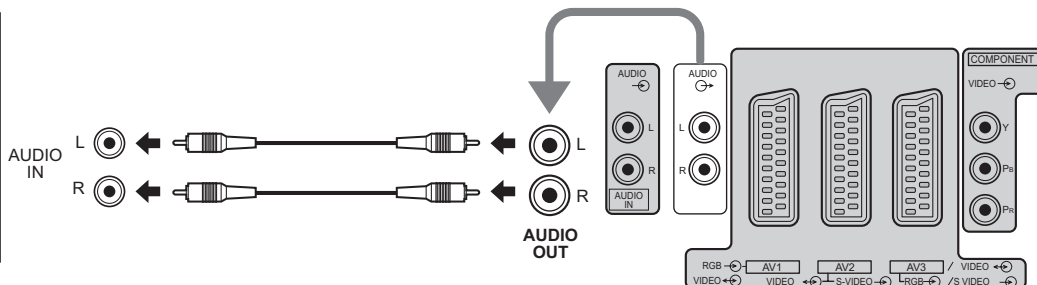
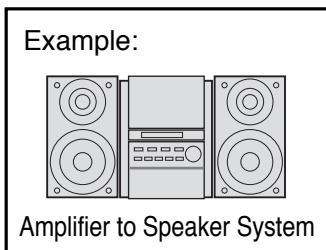
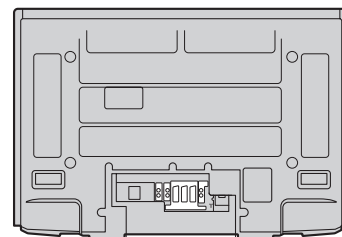

## How to connect the AV1 / 2 / 3 Scart terminals

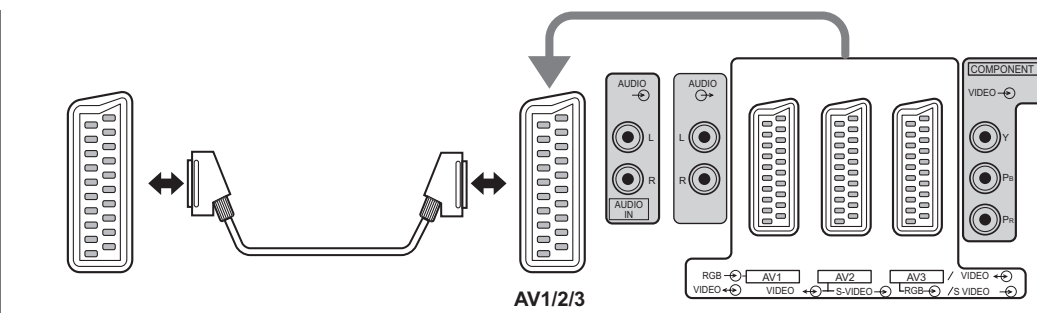
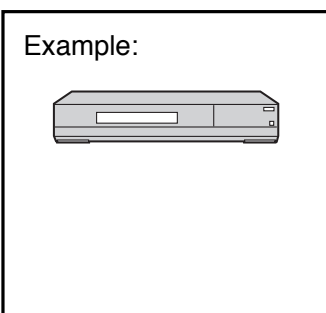

- AV1:**  
 VCR  
 SET TOP BOX  
 DVD PLAYER  
 DVD RECORDER  
 CAMCORDER  
 GAME CONSOLE /  
 COMPUTER(RGB)

- AV2:**  
 VCR / S-VIDEO VCR  
 Q-Link COMPATIBLE VCR  
 DVD PLAYER  
 DVD RECORDER  
 Q-Link COMPATIBLE  
 DVD RECORDER  
 CAMCORDER /  
 S-VIDEO CAMCORDER

- AV3:**  
 VCR / S-VIDEO VCR  
 Q-Link COMPATIBLE VCR  
 SET TOP BOX  
 DVD PLAYER  
 DVD RECORDER  
 Q-Link COMPATIBLE  
 DVD RECORDER  
 CAMCORDER /  
 S-VIDEO CAMCORDER  
 GAME CONSOLE /  
 COMPUTER(RGB)

## How to connect the Component Input terminals

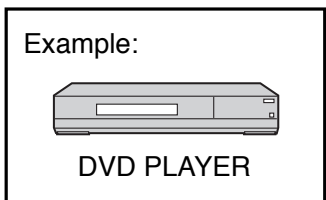

This terminal accepts progressive or non-progressive signals format, as well as high definition 750(720)/50p, 750(720)/60p, 1125(1080)/50i and 1125(1080)/60i.

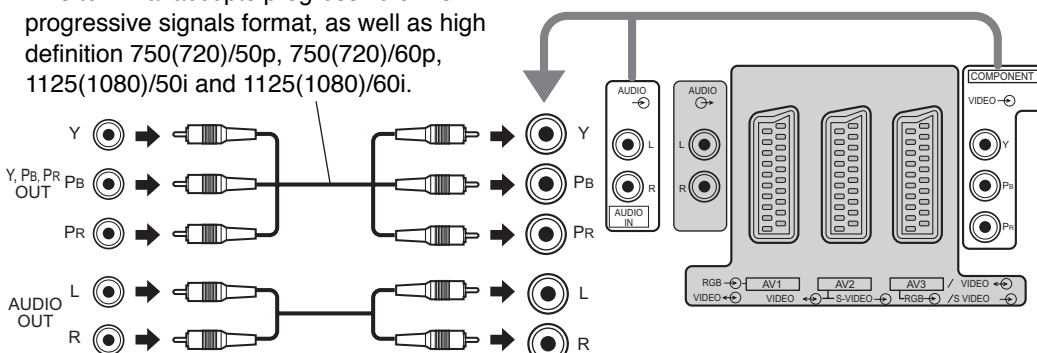

















**Notes:**

- Additional equipment and cables shown are not supplied with this TV set.
- Do not connect a computer with TTL output (5V) to this set.
- For Scart terminal wiring and applicable component signals information see page 45.

# Troubleshooting

If there is a problem with your TV please refer to the table below to determine the symptoms, then carry out the suggested check. If this does not solve the problem, please contact your local Panasonic dealer, quoting the model number and serial number (both found on the rear of the TV).

Symptoms		Checks
Picture	Sound	
 Snowy Picture	 Noisy Sound	Aerial location, direction or connection
 Multiple Images	 Normal Sound	Aerial location, direction or connection
 Interference	 Noisy Sound	Electrical appliances Cars / Motorcycles Fluorescent lights Switch on P-NR in Picture menu to reduce picture noise.
 Normal Picture	 No Sound	Volume level Sound mute switched on.
 No Picture	 No Sound	TV set to AV mode. Not plugged into AC outlet. Not switched on. Picture / Sound controls set at minimum levels. Check if in Standby mode.
 No Colour	 Normal Sound	Colour controls set at minimum levels.
 Poor or Distorted Picture	 Weak or No Sound	Retune Channel (s).
 Normal Picture	 Weak or Distorted Sound	Sound reception may have deteriorated. Switch NICAM setting (Sound menu in Analogue only) to Off until reception improves.

## CAUTION:

Symptoms	Check
Some parts of the screen do not light up.	The plasma TV panel is manufactured using an extremely high level of precision technology, however, sometimes some parts of the screen may be missing picture elements or have luminous spots. This is not a malfunction.
After-images appear 	Do not allow a still picture to be displayed for an extended period, as this can cause a permanent after-image to remain on the Plasma TV. Examples of still pictures include logos, video games, computer images, teletext and images displayed in 4:3 mode. With no signal present, and without any user operation, the Panasonic screensaver will appear automatically after a few minutes to prevent image retention. During DVB teletext, radio service or menu display, the level of the contrast will decrease automatically after a few minutes to prevent image retention. <b>Note:</b> The permanent after-image on the Plasma TV resulting from fixed image use is not an operating defect and as such is not covered by the Warranty. This product is not designed to display fixed images for extended periods of time.

## Sleep Feature

If the set is not switched off when the TV station stops transmitting, it will automatically go to standby mode after 30 minutes, This function will not operate when this TV is in AV mode.

## Notes:

- External surfaces of the unit may become hot during operation. But this is completely normal.
- See label on the base of this equipment for ratings and other information.

# DVB Troubleshooting

Some problems will only occur when viewing DVB channels. Due to the different techniques involved in digital reception, DVB signal quality can be poor even if you appear to have a strong signal when viewing analogue programmes.

The DVB system requires a good quality signal to provide the best picture. When viewing analogue pictures, interference such as signal reflection from nearby buildings or mountains causes 'ghosting', but still provides a viewable picture. For the DVB system, interference such as this can disrupt the flow of data causing the picture to appear to be made up of large blocks, or to freeze intermittently. If the picture disappears completely, this could mean that signal quality is very poor. If this happens often, you may need to improve your aerial system to provide a better signal. This TV contains a complex microprocessor which enables you to view enhanced digital services. Occasionally this device may need to be reset. This can be done by pressing the standby button on your remote control.

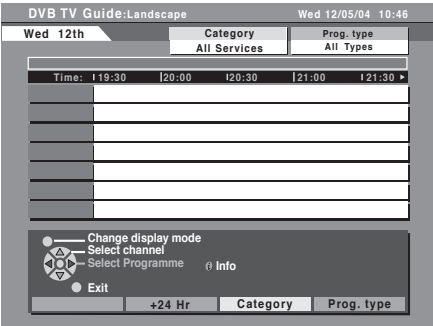
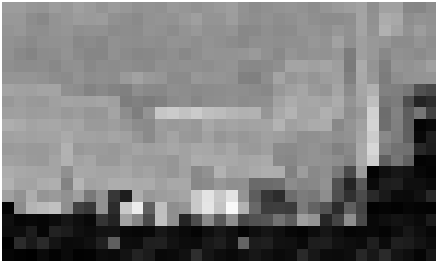
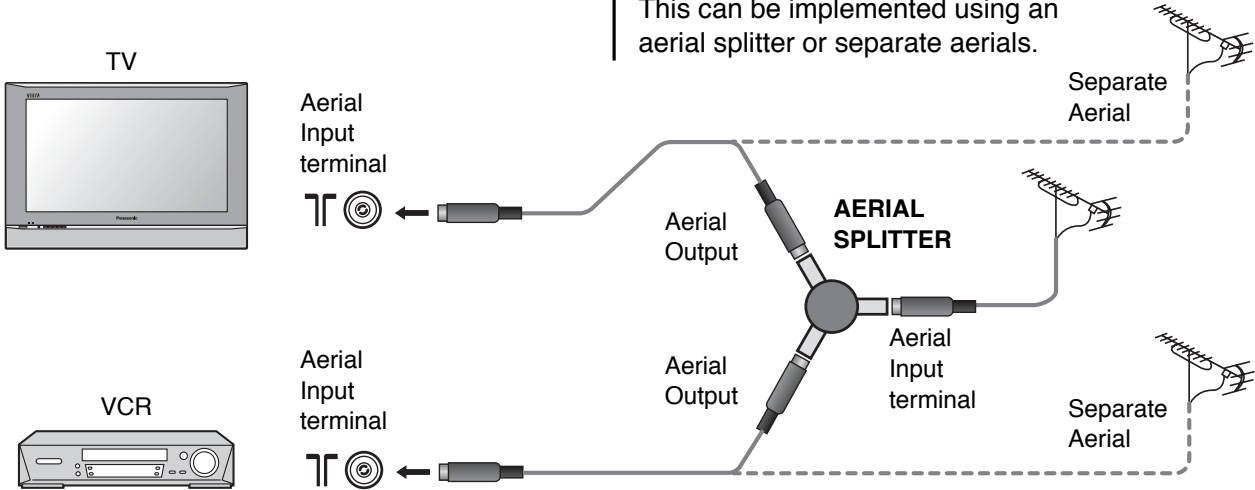
Symptoms	Checks
<p>No DVB channels listed in the TV Guide after Auto Setup.</p> 	<p>Check that DVB transmissions are available from the transmitter you are currently using. If not, try directing the aerial at another local transmitter.</p> <p>Check analogue transmissions. If picture quality is poor, you will need to improve or change your aerial system to receive DVB channels. Consult a local installer.</p>
<p>Blocky interference. Picture freezes intermittently.</p> 	<p>Blocky interference indicates that the signal quality is poor.</p> <p>You should consider improving your aerial system. To check the quality of your signal use the Signal Quality feature (see page 28).</p> <p>Good quality signal – indication is green. Poor quality signal – indication is red.</p>
<p>I have a good aerial system, but still cannot receive DVB stations.</p> 	<p>If you have tried the previous solutions and are still unable to receive DVB channels, you may need to provide dedicated aerial feeds to the TV and other equipment.</p> <p>This can be implemented using an aerial splitter or separate aerials.</p>



# Specifications

	TH-37PE50B	TH-42PE50B
<b>Power Source</b>	AC 220 - 240 V, 50 / 60 Hz	
<b>Power Consumption</b>	Average use : 253 W Standby condition : 0.3 W (Without DVB Timer programmes) 16 W (With DVB Timer programmes)	Average use : 323 W Standby condition : 0.3 W (Without DVB Timer programmes) 16 W (With DVB Timer programmes)
<b>Plasma Display panel</b>		
<b>Drive method</b>	AC type	
<b>Aspect Ratio</b>	16:9	
<b>Contrast Ratio</b>	4000:1	
<b>Visible screen size (No.of pixels)</b>	94 cmV	106 cmV
	818 mm (W) × 461 mm (H) × 939 mm (diagonal)	920 mm (W) × 518 mm (H) × 1,056 mm (diagonal)
	408,960 (852 (W) × 480 (H)) [2,556 × 480 dots]	
<b>Sound</b>		
<b>Speaker</b>	12 cm × 6 cm × 2 pcs, 6 Ω	
<b>Audio Output</b>	16 W (8 W + 8 W ), 10 % THD	
<b>Receiving Systems / Band name</b>	<b>PAL I</b> UHF E21-68. <b>PAL 525/60</b> Playback of NTSC tape from some PAL Video recorders (VCR) or NTSC disc playback from DVD player and recorder. <b>DVB</b> Digital terrestrial services via UHF aerial input. <b>M.NTSC</b> Playback from M.NTSC Video recorders (VCR). <b>NTSC (AV input only)</b> Playback from NTSC Video recorders (VCR).	
<b>Aerial - Rear</b>	UHF	
<b>Operating Conditions</b>	Temperature : 0 °C - 40 °C Humidity : 20 % - 80 % RH (non-condensing)	
<b>Connection Terminals</b>		
<b>AV1 (Scart connector)</b>	21 Pin terminal (Audio/Video in, Audio/Video out, RGB in)	
<b>AV2 (Scart connector)</b>	21 Pin terminal (Audio/Video in, Audio/Video out, S-Video in, Q-Link)	
<b>AV3 (Scart connector)</b>	21 Pin terminal (Audio/Video in, Audio/Video out, RGB in, S-Video in, Q-Link)	
<b>COMPONENT</b>	<b>VIDEO</b>	Y 1.0 Vp-p (including synchronization) PB, PR ±0.35 Vp-p
	<b>AUDIO L - R</b>	RCA PIN Type × 2 0.5 Vrms
<b>Output</b>	<b>AUDIO L - R</b>	RCA PIN Type × 2 0.5 Vrms (high impedance)
<b>Dimensions ( W × H × D )</b>	968 mm × 641 mm × 96.5 mm	1,068 mm × 701 mm × 96.5 mm
<b>Mass (Weight)</b>	28.5 kg Net	33 kg Net

## Notes:

- Design and Specifications are subject to change without notice. Weight and Dimensions shown are approximate.
- This equipment complies with the EMC standards listed below.  
EN55013, EN61000-3-2, EN61000-3-3, EN55020.





# Panasonic

## Sales and Support Information

### Customer Care Centre

- For customers within the UK : **08705 357357**
- For customers within the Republic of Ireland : **01 289 8333**
- Visit our website for product information  
**[www.panasonic.co.uk](http://www.panasonic.co.uk)**
- E-mail: **[customer.care@panasonic.co.uk](mailto:customer.care@panasonic.co.uk)**

### Direct Sales at Panasonic UK

- Order accessory and consumable items for your product with ease and confidence by phoning our Customer Care Centre Monday – Thursday 9:00am – 5:30pm, Friday 9:30am – 5:30pm (Excluding public holidays).
- Or go on line through our Internet Accessory ordering application at **[www.panasonic.co.uk](http://www.panasonic.co.uk)**.
- Most major credit and debit cards accepted.
- All enquiries transactions and distribution facilities are provided directly by Panasonic UK Ltd.
- It couldn't be simpler!
- Also available through our Internet is direct shopping for a wide range of finished products, take a browse on our website for further details.

*Exclusive to Plasma / DVD Ram / LCD Television / LCD Projector product:*

*Interested in purchasing an extended guarantee? Please contact your dealer or our Customer Support Department on 01344 476540 or **[customer.care@panasonic.co.uk](mailto:customer.care@panasonic.co.uk)** for more details.*



Trade Mark of the DVB Digital Video Broadcasting Project (1991 to 1996)  
TH-37PE50B Declaration of Conformity No 3397, 26th January 2005  
TH-42PE50B Declaration of Conformity No 3396, 26th January 2005

### **Customer' Record**

The model number and serial number of this product can be found on its rear panel. You should note this serial number in the space provided below and retain this book, plus your purchase receipt, as a permanent record of your purchase to aid in identification in the event of theft or loss, and for Warranty Service purposes.

Model Number \_\_\_\_\_

Serial Number \_\_\_\_\_

## **Panasonic (U. K.) Ltd.**

Willoughby Road, Bracknell, Berks RG12 8FP  
Web Site <http://www.panasonic.co.uk>

© 2005 Matsushita Electric Industrial Co., Ltd. All Rights Reserved.