

Panasonic®

Operating Instructions

Blu-ray Disc™ Player

Model No. DMP-BDT465
DMP-BDT460
DMP-BDT365
DMP-BDT364
DMP-BDT363
DMP-BDT361
DMP-BDT360



Firmware updates

Panasonic is constantly improving the unit's firmware to ensure that our customers are enjoying the latest technology.

Panasonic recommends updating your firmware as soon as you are notified.

For details, refer to "Firmware updates" (⇒ 14) or <http://panasonic.jp/support/global/cs/> (This site is in English only.)

Thank you for purchasing this product.

Please read these instructions carefully before using this product, and save this manual for future use.

Precautions

WARNING

Unit

To reduce the risk of fire, electric shock or product damage,

- Do not expose this unit to rain, moisture, dripping or splashing.
- Do not place objects filled with liquids, such as vases, on this unit.
- Use only the recommended accessories.
- Do not remove covers.
- Do not repair this unit by yourself. Refer servicing to qualified service personnel.
- Do not let metal objects fall inside this unit.
- Do not place heavy items on this unit.

AC mains lead

To reduce the risk of fire, electric shock or product damage,

- Ensure that the power supply voltage corresponds to the voltage printed on this unit.
- Insert the mains plug fully into the socket outlet.
- Do not pull, bend, or place heavy items on the lead.
- Do not handle the plug with wet hands.
- Hold onto the mains plug body when disconnecting the plug.
- Do not use a damaged mains plug or socket outlet.

The mains plug is the disconnecting device.

Install this unit so that the mains plug can be unplugged from the socket outlet immediately.

BDT465 | **BDT460**

Small object

Keep the Memory Card out of reach of children to prevent swallowing.

CAUTION

Unit

- This unit utilizes a laser. Use of controls or adjustments or performance of procedures other than those specified herein may result in hazardous radiation exposure.
- Do not place sources of naked flames, such as lighted candles, on this unit.
- This unit may receive radio interference caused by mobile telephones during use. If such interference occurs, please increase separation between this unit and the mobile telephone.
- This unit is intended for use in moderate climates.

Placement

Place this unit on an even surface.

To reduce the risk of fire, electric shock or product damage,

- Do not install or place this unit in a bookcase, built-in cabinet or in another confined space. Ensure this unit is well ventilated.
- Do not obstruct this unit's ventilation openings with newspapers, tablecloths, curtains, and similar items.
- Do not place the unit on amplifiers/receivers or equipment that may become hot. The heat can damage the unit.
- Do not expose this unit to direct sunlight, high temperatures, high humidity, and excessive vibration.

Batteries

Mishandling of batteries can cause electrolyte leakage and may cause a fire.

- Danger of explosion if battery is incorrectly replaced. Replace only with the type recommended by the manufacturer.
- When disposing of the batteries, please contact your local authorities or dealer and ask for the correct method of disposal.
- Do not mix old and new batteries or different types at the same time.
- Do not heat or expose to flame.
- Do not leave the battery(ies) in a car exposed to direct sunlight for a long period of time with doors and windows closed.
- Do not take apart or short circuit.
- Do not recharge alkaline or manganese batteries.
- Do not use batteries if the covering has been peeled off.

Remove batteries if you do not intend to use the remote control for a long period of time. Store in a cool, dark place.

Restriction on use of unauthorized copied content

This unit adopts the following technology for copyright protection.

Cinavia Notice

This product uses Cinavia technology to limit the use of unauthorized copies of some commercially-produced film and videos and their soundtracks. When a prohibited use of an unauthorized copy is detected, a message will be displayed and playback or copying will be interrupted.

More information about Cinavia technology is provided at the Cinavia Online Consumer Information Center at <http://www.cinavia.com>. To request additional information about Cinavia by mail, send a postcard with your mailing address to: Cinavia Consumer Information Center, P.O. Box 86851, San Diego, CA, 92138, USA.

Wireless LAN connection

The following limits are in place regarding the usage of this unit. You must be aware of these limits before using this unit. Panasonic will in no way be responsible for any incidental damage which may arise due to a failure to obey these limits, or to any condition of use or disuse of this unit.

- **Data transmitted and received over radio waves may be intercepted and monitored.**
- **This unit contains delicate electronic components.**
Please use this unit in the manner in which it was intended and follow the following points:
 - Do not expose this unit to high temperatures or direct sunlight.
 - Do not bend, or subject this unit to strong impacts.
 - Keep this unit away from moisture.
 - Do not disassemble or alter this unit in any way.

CE 1731 

Declaration of Conformity (DoC)

Hereby, "*Panasonic Corporation*" declares that this product is in compliance with the essential requirements and other relevant provisions of Directive 1999/5/EC.

Customers can download a copy of the original DoC to our R&TTE products from our DoC server:
<http://www.doc.panasonic.de>

Contact to Authorized Representative:
Panasonic Marketing Europe GmbH, Panasonic Testing Centre,
Winsbergring 15, 22525 Hamburg, Germany

This product is intended to be used in the following countries.
Austria, Belgium, Bulgaria, Cyprus, Czech Republic, Denmark,
Finland, France, Germany, Greece, Hungary, Ireland, Italy,
Iceland, Liechtenstein, Luxembourg, Malta, Netherlands,
Norway, Poland, Portugal, Romania, Slovakia, Slovenia, Spain,
Sweden, United Kingdom, Switzerland

This product is intended for general consumer. (Category 3)
The WLAN feature of this product shall exclusively be used
inside buildings.

This product on purpose to connect to access point of 2.4 GHz or
5 GHz WLAN.

To dispose or transfer this unit

The unit may keep the user settings information in the unit. If you discard this unit either by disposal or transfer, then follow the procedure to return all the settings to the factory presets to delete the user settings. (→ 31, "Return all settings to the factory preset.")

- The operation history may be recorded in the memory of this unit.

Disposal of Old Equipment and Batteries Only for European Union and countries with recycling systems



These symbols on the products, packaging, and/or accompanying documents mean that used electrical and electronic products and batteries must not be mixed with general household waste.

For proper treatment, recovery and recycling of old products and used batteries, please take them to applicable collection points in accordance with your national legislation.

By disposing of them correctly, you will help to save valuable resources and prevent any potential negative effects on human health and the environment.

For more information about collection and recycling, please contact your local municipality.
Penalties may be applicable for incorrect disposal of this waste, in accordance with national legislation.



Note for the battery symbol (bottom symbol):

This symbol might be used in combination with a chemical symbol. In this case it complies with the requirement set by the Directive for the chemical involved.

Table of contents

Precautions	2
-----------------------	---

Getting started

Accessories	5
Unit and media care	5
Playable media	6
Control reference guide	8

Connections and settings

Connecting to a TV	10
Connecting to an amplifier/ receiver	10
Connecting to the network	12
Settings	13

Playback

Inserting or removing media	15
HOME menu	16
Multi User Mode	17
Playback	18
Enjoying Network Service	20
Home Network feature	21
“HDMI CEC”	23

Settings

Option menu	24
Setup menu	26

Reference

Troubleshooting guide	31
Specifications	36

Accessories

Check the supplied accessories before using this unit.

- 1 Remote control
(N2QAYB000957)
- 2 Batteries for remote control
- 1 AC mains lead
- 1 CD-ROM



- Product numbers are provided in these operating instructions correct as of February 2014. These may be subject to change.
- Do not use AC mains lead with other equipment.

■ Using the remote control

Insert the batteries to the terminal so that it (+ and -) matches those in the remote control.

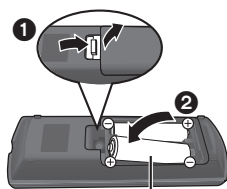

R6/LR6, AA

(Alkaline or manganese batteries)

Point it at the remote control signal sensor on this unit. (⇒ 9)

Unit and media care

■ Clean this unit with a soft, dry cloth

- Never use alcohol, paint thinner or benzine to clean this unit.
- Before using chemically treated cloth, carefully read the instructions that came with the cloth.

■ This unit's lens

Lens cleaner: RP-CL720AE

- This lens cleaner may not be available for sale in all countries, e.g. not available in Germany, please consult your Panasonic dealer for advice.
- This lens cleaner is sold as specific for DIGA, but can be used on this unit as well.

■ Clean discs

DO

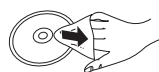

DO NOT









Wipe with a damp cloth and then wipe dry with a dry cloth.

■ Disc and card handling precautions

- Handle discs by the edges to avoid inadvertent scratches or fingerprints on the disc.
- Do not attach labels or stickers to discs.
- Do not use disc cleaning sprays, benzine, thinner, static electricity prevention liquids or any other solvent.
- **BDT465** **BDT460** Clean any dust, water, or foreign matter from the terminals on the rear side of the card.
- Do not use the following discs:
 - Discs with exposed adhesive from removed stickers or labels (rented discs, etc.).
 - Discs that are badly warped or cracked.
 - Irregularly shaped discs, such as heart shapes.

Playable media

Device	Media markings	Device types	Contents format
BD		BD-Video	Video
		BD-RE	Video, JPEG, MPO
		BD-R	Video, MKV, Xvid
DVD		DVD-Video	Video
		DVD-R	Video, AVCHD, MKV, Xvid, JPEG, MPO, AAC, FLAC, MP3, WAV, WMA
		DVD-R DL	
		DVD-RW	Video, AVCHD
	—	+R/+RW/+R DL	
	CD		Music CD
—		CD-R CD-RW	MKV, Xvid, JPEG, MPO, AAC, FLAC, MP3, Music [CD-DA], WAV, WMA
SD*		SD Memory Card (from 8 MB to 2 GB) SDHC Memory Card (from 4 GB to 32 GB) SDXC Memory Card (48 GB, 64 GB) (Compatible with both mini and micro types)	AVCHD, AVCHD 3D, MP4, JPEG, MPO
USB	—	USB devices (up to 2 TB)	MKV, MP4, MPEG2, Xvid, JPEG, MPO, AAC, FLAC, MP3, WAV, WMA

* BDT465 BDT460

- See pages 7 and 36 for more information on the types of content that can be played.

■ Types of discs that cannot be played by this unit

Any other disc that is not specifically supported or previously described.

- DVD-RAM
- Super Audio CD
- Photo CD
- DVD-Audio
- Video CD and Super Video CD
- HD DVD

■ Region management information

The unit can play back BD-Video/DVD-Video discs of the following regions codes, including "ALL":

Example: BD-Video DVD-Video



■ Finalize

Any DVD-R/RW/R DL, +R/+RW/+R DL and CD-R/RW that are recorded by a recorder need to be finalized by the recorder to play on this unit. Please refer to the recorder's instructions.

■ BD-Video

- This unit supports high bit rate audio (Dolby® Digital Plus, Dolby® TrueHD, DTS-HD High Resolution Audio™ and DTS-HD Master Audio™) adopted in BD-Video.
- **BDT365** **BDT364** **BDT363** **BDT361** **BDT360**
If "Dolby D/Dolby D +/Dolby TrueHD" is set to "PCM" and "DTS Neo:6" is set to "Off", the maximum possible number of Dolby® sound is 5.1ch PCM. (⇒ 27)

■ 3D

- 3D videos and 3D still pictures can be played back when this unit is connected to a 3D compatible TV using a High Speed HDMI Cable.
- 2D video can be enjoyed as 3D virtually. (⇒ 25)

■ Music CD

Operation and sound quality of CDs that do not comply with CD-DA specifications (copy control CDs, etc.) cannot be guaranteed to work.

■ SD card

BDT465 **BDT460**

- miniSD Cards, microSD Cards, microSDHC Cards and microSDXC Cards can be used, but must be used with an adaptor card. These are usually supplied with such cards, or otherwise customer provided.
- To protect the card's contents, move the record prevention tab (on the SD card) to "LOCK".
- This unit is compatible with SD Memory Cards that meet SD Card Specifications FAT12 and FAT16 formats, as well as SDHC Memory Cards in FAT32 format and SDXC Memory Cards in exFAT.
- If the SD card is used with incompatible computers or devices, recorded contents may be erased due to the card being formatted etc.
- Usable memory may be slightly less than the card capacity.



■ USB device

- This unit does not guarantee connection with all USB devices.
- This unit does not support USB device charging.
- FAT12, FAT16, FAT32, and NTFS file systems are supported.
- This unit supports USB2.0 High Speed.
- This unit supports an HDD formatted in FAT32 and NTFS. If the HDD is not recognized, the power to the HDD may not be supplied. Supply power from an external source.

■ BD-RE, BD-R

Discs recorded in DR mode using Panasonic Blu-ray Disc recorders may not play back the audio etc., correctly.



- It may not be possible to play the above media in some cases due to the type of media, the condition of the recording, the recording method, and how the files were created.
- The producers of the disc can control how discs are played, so you may not always be able to control play as described in these operating instructions. Read the disc's instructions carefully.

Control reference guide

When other Panasonic devices respond to the remote control of the unit, change the remote control code. (⇒ 30)

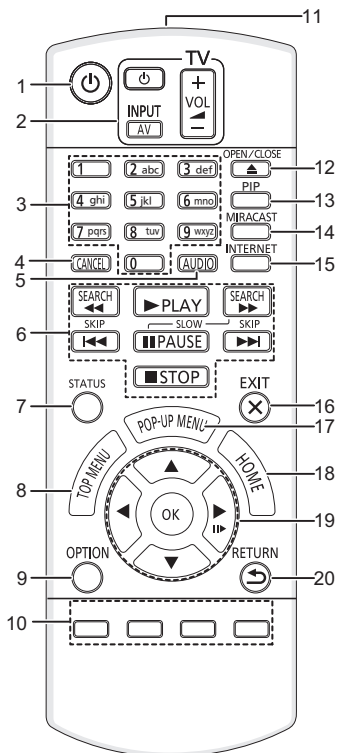

- 1 Turn the unit on and off
- 2 TV operation buttons
You can operate the Panasonic TV using this unit's remote control. Some buttons may not work depending on the TV.
[TV] : Turn the TV on and off
[AV] : Change input
[+ - VOL] : Adjust the volume
- 3 Select title numbers, etc./Enter numbers or characters
- 4 Cancel
- 5 Change audio (⇒ 18)
- 6 Basic playback control buttons (⇒ 18)
- 7 Show the status messages (⇒ 19)
- 8 Show Top menu (⇒ 18)
- 9 Show Option menu (⇒ 24)
- 10 Coloured buttons (red, green, yellow, blue)
Used for various purposes depending on the display
- 11 Transmit the remote control signal
- 12 Open or close the disc tray (⇒ 15)
- 13 Switch Secondary Video on/off (Picture-in-picture) (⇒ 24)
- 14 Show Miracast™ screen (⇒ 21)
- 15 Show the Home Screen of the Network Service (⇒ 20)
- 16 Exit the Menu screen
- 17 Show Pop-up menu (⇒ 18)
- 18 Show HOME menu (⇒ 16)
- 19 [▲, ▼, ◀, ▶] : Move the highlight for selection
[OK] : Confirm the selection
[◀▶] : Frame-by-frame (⇒ 18)
- 20 Return to previous screen

e.g., **BDT465** **BDT460**

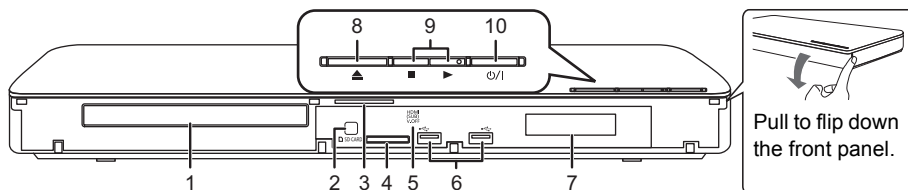

- | | |
|---------------------------------------------------------------------------------------------------------------------------------------------------------------------------------------------------------------------------------------------------------------------------------------------------------------------------------------------------------------------------------------------------------------------------------------------------------|------------------------------------------------------------------------------------------------------------------------------------------------------------------------------------------------------------------------------------------------------------------------------------------------------------------------------------------------------------------------|
| <p>1 Disc tray (⇒ 15)</p> <p>2 Remote control signal sensor
Distance: Within approx. 7 m
Angle: Approx. 20° up and down, 30° left and right</p> <p>3 BDT465 BDT460 Blue LED
It is possible to set the LED to turn on/off.
(⇒ 30)</p> <p>4 BDT465 BDT460 SD card slot (⇒ 15)</p> <p>5 BDT465 BDT460 V.OFF LED (Video off LED)
It is possible to set the LED to turn on/off.
(⇒ 30)</p> | <p>6 USB ports (⇒ 15)</p> <p>7 Display</p> <p>8 Open or close the disc tray (⇒ 15)</p> <p>9 Basic playback control switches (⇒ 18)</p> <p>10 Standby/on switch (⏻/⏻) (⇒ 13)
Press to switch the unit from on to standby mode or vice versa. In standby mode, the unit is still consuming a small amount of power.</p> <p>Rear panel terminals (⇒ 10–12)</p> |
|---------------------------------------------------------------------------------------------------------------------------------------------------------------------------------------------------------------------------------------------------------------------------------------------------------------------------------------------------------------------------------------------------------------------------------------------------------|------------------------------------------------------------------------------------------------------------------------------------------------------------------------------------------------------------------------------------------------------------------------------------------------------------------------------------------------------------------------|

Connecting to a TV

Connect the AC mains lead after making all connections.

- Before making any connections, we recommend that you temporarily disconnect all the units from AC power.
- Use the High Speed HDMI cables. Non-HDMI-compliant cables cannot be utilized.
It is recommended that you use Panasonic's HDMI cable. When outputting 1080p or 24p (4K) signal, please use HDMI cables 5.0 meters or less.

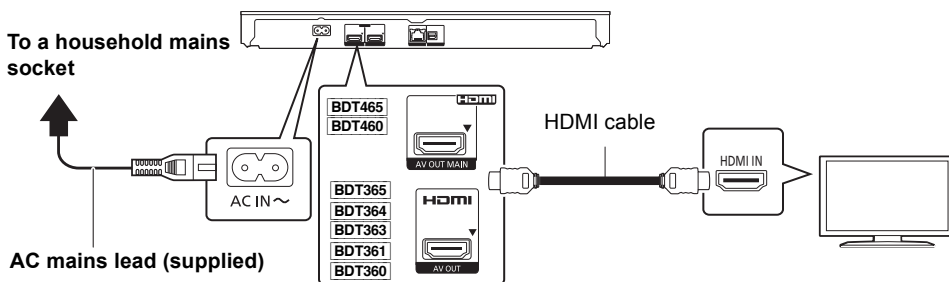

- **BDT465** **BDT460** : Use HDMI AV OUT MAIN terminal.
- This unit consumes a small amount of AC power (⇒ 36) even when turned off in standby mode. For the purpose of energy conservation, the unit should be disconnected if you will not be using it for extended period of time.

Connecting to an amplifier/receiver

Perform either one of the following connections in accordance with your amplifier/receiver input terminal.

HDMI AV OUT

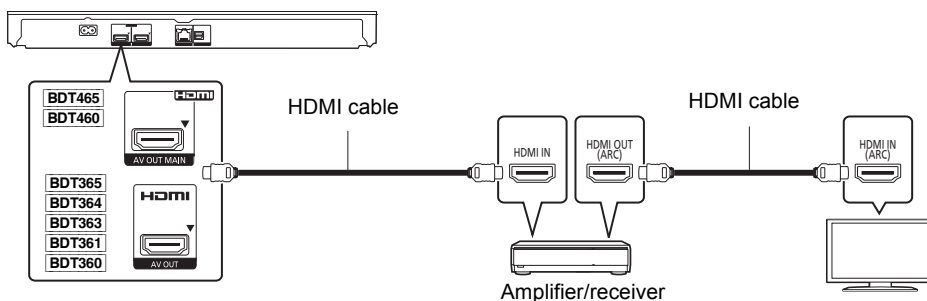

- **BDT465** **BDT460** : Use HDMI AV OUT MAIN terminal.
- Set "Digital Audio Output" (⇒ 27).
- When connecting to a non-3D or 4K compatible amplifier/receiver, connect this unit to a TV, then connect the TV and the amplifier/receiver. Please note, however, that the audio can only be up to 5.1ch.
- When using the TV or amplifier/receiver that does not have the indication of "(ARC)" (non-ARC-compatible) on the HDMI terminal, the amplifier/receiver and TV must also be connected using an optical digital cable in order to enjoy the TV's sound through the amplifier/receiver.

HDMI AV OUT SUB BDT465 BDT460

You can enjoy richer sound by using the HDMI AV OUT SUB terminal.

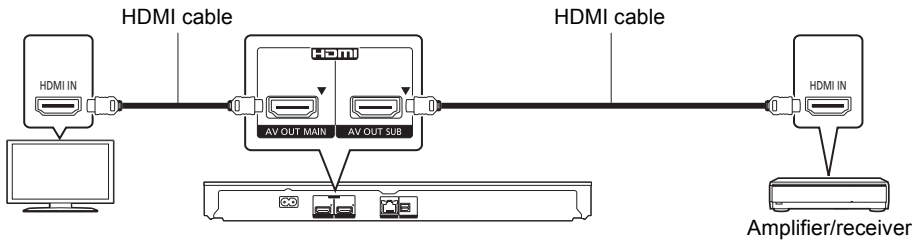

- Set “HDMI(SUB) Output Mode” to “V.OFF(Video Off)”. (⇒ 27)
 - Audio is output in high resolution regardless of compatibility of the amplifier/receiver with 3D.
- It is possible to play back 3D videos, 3D still pictures and 24p (4K) videos, etc., when the connected TV is 3D or 4K compatible, even if the amplifier/receiver is not 3D or 4K compatible.
- The HDMI connection using HDMI AV OUT MAIN supports HDMI CEC (⇒ 23).
The HDMI AV OUT SUB terminal is not compatible with the HDMI CEC.

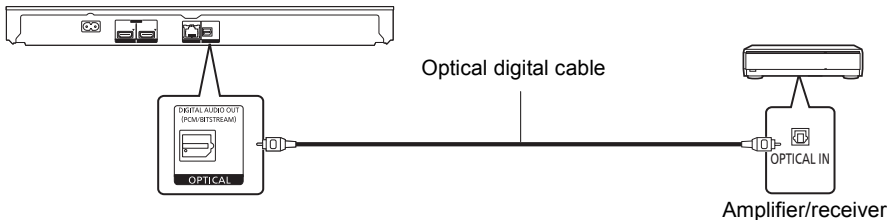
OPTICAL

- Set “HDMI Audio Output” to “Off” (⇒ 27).
- Set “Digital Audio Output” (⇒ 27).

Connecting to the network

The following services can be used when this unit is connected to broadband.

- Firmware can be updated (⇒ 14)
- You can enjoy BD-Live (⇒ 19)
- You can enjoy Network Service (⇒ 20)
- You can access other devices (Home Network) (⇒ 21)
- This unit supports Wi-Fi Direct™ and can make a wireless connection to wireless devices without router. You can use this function when enjoying Home Network feature, etc. Internet access is not available while connected via Wi-Fi Direct™. (⇒ 21, 28)

For details about connection method, refer to the instructions supplied with the connected equipment.

Wireless LAN connection

This unit has built-in Wi-Fi® and can be connected to a wireless router.



- For up-to-date compatibility information on your wireless router, refer to <http://panasonic.jp/support/global/cs/> (This site is in English only.)
- The unit is not compatible with public wireless LAN services provided in airports, stations, cafes, etc.
- See page 3 for the precautions for wireless LAN connection.

LAN cable connection

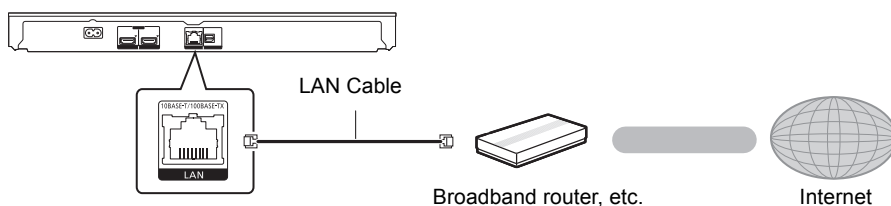

- Use category 5 or above straight LAN cables (STP) when connecting to peripheral devices.
- Inserting any cable other than a LAN cable in the LAN port can damage the unit.

Settings

The following settings can be performed anytime in the Setup menu. (⇒ 28, 29)

Easy Settings

After connecting your new player for the first time and pressing [⏏], the basic settings screen will appear.

Preparation

Turn on the TV and select the appropriate video input.

1 Press [⏏].

Setup screen appears.

2 Follow the on-screen instructions to continue with the settings.

Easy Network Setting

After completing “Easy Settings”, you can perform “Easy Network Setting”.

Select “Wired” or “Wireless” and press [OK].

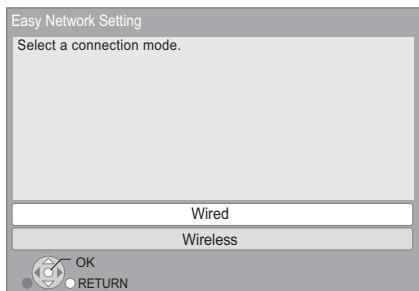

Follow the on-screen instructions to establish your connection settings.

■ About the wireless connection

Before beginning wireless connection setup

- Obtain your network name (SSID*).
- If your wireless connection is encrypted, please be sure that you know your encryption key.

If your SSID is not displayed;

- Search again by pressing the red button on the remote control.
- Stealth SSIDs will not be displayed; in this case, enter manually by using “Manual setting”. Press [HOME]
 - ⇒ press [OK] to select “Setup”
 - ⇒ select “Player Settings”
 - ⇒ select “Network” and press [OK]
 - ⇒ select “Network Settings” and press [OK]
 - ⇒ select “Wireless Settings” and press [OK]
 - ⇒ select “Connection Setting” and press [OK]
 - ⇒ select “Manual setting” and press [OK]

If your wireless network is encrypted;

Encryption Key input screen will be displayed. Input the encryption key of your network.

If your wireless router is supports WPS (Wi-Fi Protected Setup™);

You can easily set up a connection by pressing the green button on the remote control.



- Refer to the operating instructions of the hub or router.
- Do not use this unit to connect to any wireless network for which you do not have usage rights. Using these networks may be regarded as illegal access.
- If you have trouble getting online on your PC after performing network settings on this unit, perform the network settings on your PC.
- Please be aware that connecting to a network without encryption may result in the leaking of data such as personal or secret information.

* SSID:

An SSID (Service Set Identification) is a name used by wireless LAN to identify a particular network. Transmission is possible if the SSID matches for both devices.

Firmware updates

Occasionally, Panasonic may release updated firmware for this unit that may add or improve the way a feature operates. These updates are available free of charge.

This unit is capable of checking the firmware automatically when connected to the Internet via a broadband connection.

When a new firmware version is available, the following message is displayed.

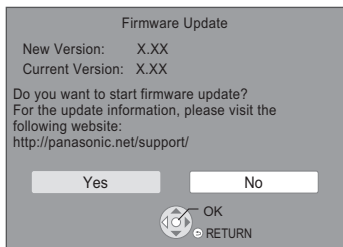

DO NOT DISCONNECT the unit from the AC power or perform any operation while the update takes place.

After the firmware is installed, "FIN" will be displayed on the unit's display. Unit will restart and the following screen will be displayed.

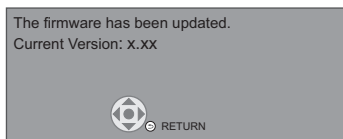

- If downloading on this unit fails or this unit is not connected to the Internet, then you can download the latest firmware from the following website and burn it to a CD-R to update the firmware.
<http://panasonic.jp/support/global/cs/>
(This site is in English only.)
To show the firmware version on this unit. (⇒ 30, "Firmware Version Information")
- Downloading will require several minutes. It may take longer or may not work properly depending on the connection environment.
- If you do not want to check for the latest firmware version, set "Automatic Update Check" to "Off". (⇒ 30)

Inserting or removing media

e.g., **BDT465** **BDT460**

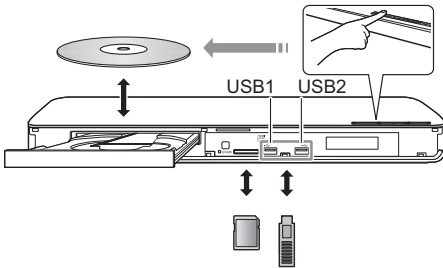

Notes

- When inserting a media item, ensure that it is facing the correct way, which is the right side facing up.
- **BDT465** **BDT460** When removing the SD card, press the centre of the card and pull it straight out.
- If you connect a Panasonic product with a USB connection cable, the setup screen may be displayed on the connected equipment. For details, refer to the instructions for the connected equipment.
- When you connect a USB HDD, use the right USB port (USB2).

CAUTION

Do not place objects in front of the unit. The disc tray may collide with objects when it is opened, and this may cause malfunction.

HOME menu

Major functions of this unit can be operated from the HOME menu.

Preparation

Turn on the TV and select the appropriate video input.

1 Press [⏻] to turn on the unit.

- After network service introduction banner is shown, the HOME menu is displayed.
 - When connected to the network, the banner content may be changed.
 - You can disable the “Start-up Banner” (⇒ 30).

2 Press [OK] or [▲, ▼, ◀, ▶] to select the item.

- If there are any other items, repeat this step.

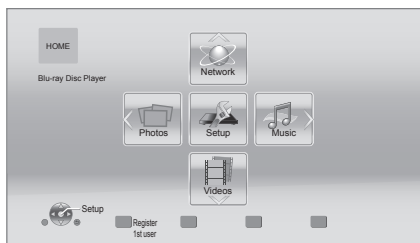

Videos/Photos/Music

Disc	Play back the contents. (⇒ 18)
USB	<ul style="list-style-type: none"> • When multiple contents are recorded, select the types of contents or the title. • “USB1” indicates the left USB port, while “USB2” indicates the right one. (⇒ 15)
SD Card	[BDT465] [BDT460]

Network

Network Service	Displays the Home Screen of Network Service. (⇒ 20)
Home Network	DLNA Client (⇒ 21)
	Miracast (⇒ 21)
	Media Renderer (⇒ 22)

Setup

Player Settings	(⇒ 26)
USB Management	(⇒ 19)
Wallpaper	Changes the background of HOME menu.

To show the HOME menu

Press [HOME].



- Items to be displayed may vary with the media.
- Where necessary, set “Mixed Data Disc Option” when using a disc with both data files (MP3, JPEG, MKV, etc.) and Video (BD-DAV and AVCHD). (⇒ 30)

Multi User Mode

Multi User Mode allows individuals to customize settings and switch to their saved settings easily. Up to four people can use the unit with their own settings.

The following settings can be personalized:

- The user icon
- The wallpaper of HOME menu
- The specific settings (⇒ 24, 26)

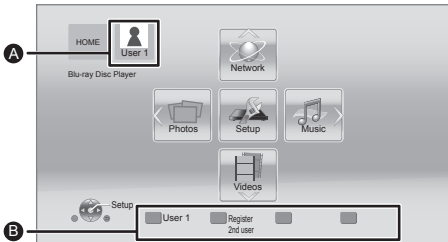

- A** The user name and icon currently selected
- B** Personalize a new user and switch between users with coloured buttons.

Personalizing a new user

- 1** Press [HOME].
- 2** Press the coloured button that indicates new user personalization.
- 3** Select an item and change the settings according to the indications.

The following items can be set.

Input Nickname	Personalize a user name.
Select Icon	<p>Personalize a user icon.</p> <p>Select from Illustrations The image can be selected from prepared illustrations.</p> <p>Create from Photos You can select a photo in recording media as an icon. (⇒ 24, "Icon Registration")</p>
Select Wallpaper	<p>Personalize a background of the HOME menu.</p> <ul style="list-style-type: none"> • In addition to the default wallpapers, you can select a photo in recording media as a wallpaper. (⇒ 24, "Wallpaper")

- 4** Select "Confirm" and press [OK].

To change the personalized user information
Select "Edit User Information" from Setup menu.
(⇒ 30)

Switching the user information

Press the coloured buttons in the HOME menu to switch to the user information corresponding to the button.

Playback

1 Insert the media.

Playback starts depending on the media.

2 Select the item to play and press [OK].

Repeat this step if necessary.



- DISCS CONTINUE TO ROTATE WHILE MENUS ARE DISPLAYED. Press [■STOP] when you have finished playback to protect the unit's motor, your TV screen and so on.
- [BDT465] [BDT460] When the following conditions are met, a still picture will be played back in 4K. The resolution of the still picture will be changed automatically.
 - The unit is connected to a 4K compatible TV
 - "HDMI Video Format" is set to "Automatic" (⇒ 26)
 - The still picture is being played back in 2D
- It is not possible to play back AVCHD and MPEG2 videos which have been dragged and dropped or copied and pasted to the media.
- To save on electricity, this unit is turned off automatically if there is no button operation for about 20 minutes when not playing back (such as when paused or displaying the menu, displaying still pictures, etc.).

Operations during playback

The following functions may not work depending on the media and contents.

Stop

Press [■STOP].

The stopping point is memorized.

Resume play function

Press [▶PLAY] to restart from this point.

- The point is cleared if the media is removed.
- **On BD-Video discs including BD-J, the resume play function does not work.**

Pause

Press [⏸PAUSE].

- Press [⏸PAUSE] again or [▶PLAY] to restart play.

Search/Slow motion

Search

While playing, press [SEARCH◀◀] or [SEARCH▶▶].

Slow motion

While paused, press [SEARCH▶▶].

The speed increases up to 5 steps.

- Music, MP3, etc.: The speed is fixed to a single step.
- Press [▶PLAY] to revert to normal playback speed.

Skip

While playing or paused, press [◀◀] or [▶▶].

Skip to the title, chapter or track.

Frame-by-frame

While paused, press [▶] (⏪▶).

- Press and hold to fast forward.
- Press [▶PLAY] to revert to normal playback speed.

Changing audio

Press [AUDIO].

You can change the audio channel number or soundtrack language, etc.

Show top menu/pop-up menu

Press [TOP MENU] or [POP-UP MENU].

Select the item and press [OK].

Show the status messages

While playing, press [STATUS].

The status messages give you information about what is currently being played. Each time you press [STATUS], the display information may change or disappear from the screen.

- Depending on media and contents, the display may change or not appear.

e.g., BD-Video



- A** T: Title, C: Chapter, PL: Playlist
- B** Elapsed time in the title
- C** Current position
- D** Total time

e.g., JPEG



Enjoying 3D video and photos

Preparation

- Connect this unit to a 3D compatible TV. (⇒ 10)
- Perform the necessary preparations for the TV.
- Play back following the instructions displayed on the screen.
- 3D Settings (⇒ 25, 28)



- Please refrain from viewing 3D images if you do not feel well or are experiencing visual fatigue. In the event that you experience dizziness, nausea, or other discomfort while viewing 3D images, discontinue use and rest your eyes.
- 3D video might not output the way it is set in "HDMI Video Format" and "24p(4K)/24p Output" (⇒ 26).
- When playing back 3D photos from "Photos" screen, select from the "3D" list. (Still pictures in "2D" are played back in 2D.) If "2D" and "3D" indications are not displayed, press the red button on the remote control to switch the view of playback contents.

Enjoying BD-Live

With "BD-Live" discs, you can enjoy bonus contents that use Internet access.

For this BD-Live function, connection of a USB device is necessary along with Internet connection.

- When USB devices are connected to both USB ports, disconnect both of them first, and then connect only the one you want to use.

1 Perform network connection and settings.
(⇒ 12, 13)

2 Connect a USB device with 1 GB or more free space.

- The USB device is used as the local storage.

3 Insert the disc.

Deleting data on the USB device

Select "USB Management" in the HOME menu (⇒ 16), then select "BD-Video Data Erase" and press [OK].



- The usable functions and the operating method may vary with each disc, please refer to the instructions on the disc and/or visit their website.
- "BD-Live Internet Access" may need to be changed for certain discs (⇒ 29).

Slideshow

Play a slideshow of photos and adjust various settings during the playback.

1 Insert the media.

2 Select "Photos".

3 Select an item and press the green button.

The following items can be set.

Start Slideshow	Start the slideshow. You can display still pictures in the selected folder one by one at a constant interval.
Interval	Change the display interval.
Transition Effect	Select the effect when sliding pictures.
Repeat Play	Set whether to repeat the slideshow.



- Still pictures displayed as "☒" cannot be played back with this unit.

Enjoying Network Service

Network Service allows you to access some specific websites supported by Panasonic.

Network Service provides a variety of selected Internet services such as the following.

- Online movie rental service
- Video browsing service

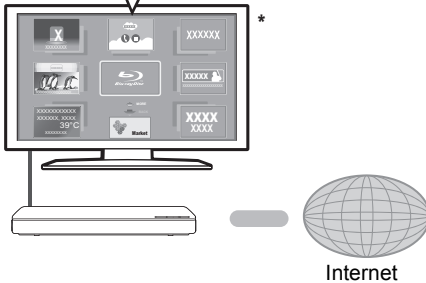

* Images are for illustration purposes, contents may change without notice.

Preparation

- Network connection (⇒ 12)
- Network settings (⇒ 13)

1 Press [INTERNET].

2 Select the item and press [OK].

To exit from Network Service

Press [HOME].



- When playing content in the media, Network Service cannot be accessed by pressing [INTERNET].
- In the following cases, settings are possible using the Setup menu items.
 - When restricting the use of Network Service (⇒ 29, "Network Service Lock")
 - When correcting the displayed time (⇒ 29, "Time Zone", "Summer Time")
 - When using another device such as a smartphone in combination with the unit by using a certain app on the device (⇒ 29, "Remote Device Operation")
- When using a slow Internet connection, the video may not be displayed correctly. A high speed Internet service with a speed of at least 6 Mbps is recommended.
- Be sure to update the firmware as soon as a firmware update notice is displayed on the screen. If the firmware is not updated, you may not be able to use Network Service function properly. (⇒ 14)
- Network Service Home Screen is subject to change without notice.
- The services through Network Service are operated by their respective service providers, and service may be discontinued either temporarily or permanently without notice. Therefore, Panasonic will make no warranty for the content or the continuity of the services.
- Some features of websites or content of the service may not be available.
- Some content may be inappropriate for viewers.
- Some content may only be available for specific countries and may be presented in specific languages.

Home Network feature

Before using the following features, be sure to configure the connected equipment on your Home Network.

Using Miracast™

You can enjoy the content you are viewing on a Miracast-compatible smartphone, etc. on the big screen of your TV.

- Compatible with Android™ devices, ver. 4.2 and above and Miracast certified.

For information on whether the smartphone, etc. supports Miracast, contact the manufacturer of the device.

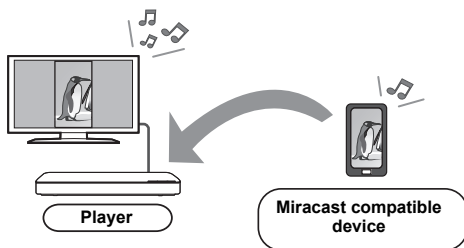

1 Press [MIRACAST].

2 Operate the Miracast compatible device.

- On the device, enable Miracast and select this unit* as the device to be connected. For details, refer to the instructions supplied with the device.

* The unit name will be displayed in the following;

BDT465 BDT460 ⇨ DMP-BDT460/5
 BDT365 BDT364 BDT363 BDT361 BDT360
 ⇨ DMP-BDT360/1/3/4/5

To exit from Miracast

Press [HOME].

Playing back contents on the DLNA server

You can share photos, videos and music stored in the DLNA Certified media server [PC with Windows 7 installed, smartphone, recorders (DIGA), etc.] connected to your home network.

• About support format of DLNA (⇨ 37).

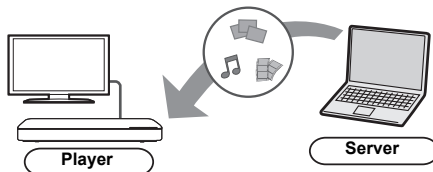

Preparation

- ① Perform network connection (⇨ 12) and network settings (⇨ 13) of this unit.
- ② Add the contents and folder to the libraries of the Windows Media® Player or the smartphone, etc.
 - Playlist of Windows Media® Player can play back only the contents that are stored in the libraries.

- When connected to DIGA, register this unit to your DIGA.

1 Press [HOME].

2 Select “Network”.

3 Select “Home Network”.

4 Select “DLNA Client”.

- The list can be updated by pressing the red button on the remote control.
- The connection method can be switched to Wi-Fi Direct by pressing the green button on the remote control.

5 Select the equipment and press [OK].

6 Select the item to play and press [OK].

- You may be able to use convenient functions depending on the content by pressing [OPTION].

To exit from Home Network

Press [HOME].

Using the Digital Media Controller

You can use a smartphone or tablet as the Digital Media Controller (DMC) to playback contents from DLNA server on the Renderer (this unit).

Possible applications:

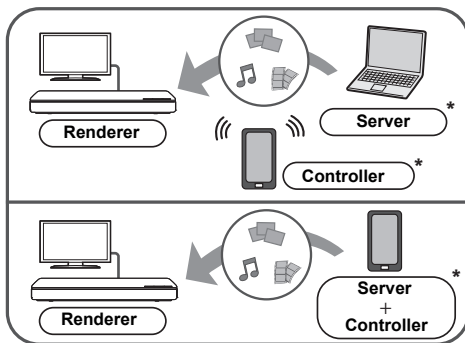

* DMC compatible software should be installed.

Preparation

Perform steps ① and ②. (⇒ 21)

③ Perform the “Remote Device Settings”.
(⇒ 29)

- With the default setting, the unit name will be displayed in the following;

BDT465 **BDT460** ⇒ DMP-BDT460/5

BDT365 **BDT364** **BDT363** **BDT361** **BDT360**

⇒ DMP-BDT360/1/3/4/5

- You can register up to 16 devices.

- 1 Press [HOME].
- 2 Select “Network”.
- 3 Select “Home Network”.
- 4 Select “Media Renderer”.
- 5 Select “Home Network” or “Wi-Fi Direct” and press [OK], then follow the indications on the screen.
- 6 Operate the DMC compatible devices.

To exit from Media Renderer screen

Press [HOME].



About DLNA and Media Renderer

For more details, refer to the following website and the operating instructions for each of the equipment.

<http://panasonic.jp/support/global/cs/>
(This site is in English only.)

- Wi-Fi Direct connection while using Home Network feature is only temporary, and the network connection method returns to the original setting when exiting.
- Depending on the device or connection environment, the data transfer rate may decrease.
- Depending on the contents and the connected equipment, playback may not be possible.
- Items displayed in grey on the display cannot be played back by this unit.

“HDMI CEC”

This unit supports “HDMI CEC” (Consumer Electronics Control) function.

You can use this function by connecting the equipment with an HDMI cable*.

See the operating instructions for connected equipment for operational details.

* **BDT465** **BDT460** Only when connecting via an HDMI AV OUT MAIN terminal on this unit.

Preparation

- ① Set “HDMI CEC” to “On” (⇒ 30).
(The default setting is “On”.)
- ② Set the “HDMI CEC” operations on the connected equipment (e.g., TV).
- ③ Turn on all “HDMI CEC” compatible equipment and select this unit’s input channel on the connected TV so that the “HDMI CEC” function works properly.

Repeat this procedure when the connections or settings are changed.

Automatic input switching Power on link

When the unit starts playback, the TV will automatically switch the input channel and the screen of the unit will be displayed. Additionally when the TV is off, the TV will automatically turn on.

Power off link

All connected equipment compatible with “HDMI CEC”, including this unit, automatically turns off when you switch the TV off.



- This unit supports the “HDMI CEC” (Consumer Electronics Control) function. However, operation cannot be guaranteed on all HDMI CEC devices.

Option menu

A variety of playback operations and settings can be performed from this menu.

Available options differ depending on the playing contents and the condition of the unit.

About Multi User Mode

 : Settings of the items with this indication are saved by the respective users registered in the HOME menu. (⇒ 17)

1 Press [OPTION].

- When playing music, select "Playback Settings" and press [OK].

e.g., BD-Video

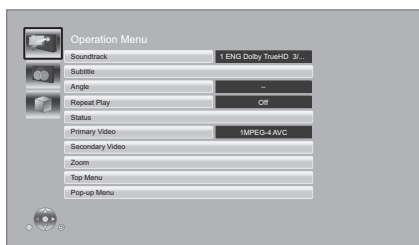

2 Select an item and change the settings.

To exit the screen

Press [OPTION].

Regarding Language : (⇒ 37)

Operation Menu

■ Soundtrack

Show or change the soundtrack.

■ Audio channel

Select the audio channel number.

■ Subtitle

Change the subtitle settings.

■ Angle

Select the number of the angle.

■ Repeat Play

Select the item that you want to repeat.

- You can repeat the playback of a chapter, playlist, the entire disc, etc., but the items displayed will differ depending on the type of the media.
- Select "Off" to cancel.

■ Random

Select whether or not to play random.

■ Start Slideshow

Start the slideshow.

■ Status

Show the status messages.

■ Rotate RIGHT

■ Rotate LEFT

Rotate the still picture.

■ Wallpaper

Set the still picture to the wallpaper of HOME menu. (⇒ 16)

■ Icon Registration

Set the still picture as your user icon. (⇒ 17)

■ Video

The recording method of original video appears.

■ Primary Video

The recording method of original primary video appears.

■ Secondary Video

Video	Select on/off for images. The recording method of original video appears. <ul style="list-style-type: none"> During search/slow motion or frame-by-frame, only the primary video is displayed.
Soundtrack	Select on/off for audio and the language.

■ Zoom

Videos and pictures are magnified.

■ Top Menu

Display Top Menu.

■ Pop-up Menu

Display Pop-up Menu.

■ Menu

Display Menu.

Picture Settings

Picture Mode

Select the picture quality mode during play.

- If you select “User”, you can change settings in “Picture Adjustment”.

Picture Adjustment

Specific picture quality settings can be changed.

Progressive

Select the method of conversion for progressive output to suit the type of material being played.

- If the video is disrupted when “Auto” is selected, select either “Video” or “Film” depending on the material to be played back.

24p

Movies and other material recorded on DVD-Video at 24p are output at 24p.

- Only when you have selected “24p(4K)” or “24p” in “24p(4K)/24p Output” (⇒ 26) and play discs recorded at a rate of 60 fields per second.
- This may not work with the PAL contents.

Reset to Default Picture Settings

Return picture settings to the factory defaults.

3D Settings

Signal Format

Original	Keep original picture format.
Side by side	3D picture format comprising of left and right screens.
2D to 3D	Converts 2D pictures to 3D effect.

Distance

Set the amount of depth perception.

Graphic Display Level

3D position for the Option menu or message screen, etc. can be adjusted during 3D playback.

Setup menu

Change the unit's settings if necessary. The settings remain intact even if you switch the unit to standby.

Some items are common to the Option menu. You can get the same effect with both menus.

About Multi User Mode

 : Settings of the items with this indication are saved by the respective users registered in the HOME menu. (⇒ 17)

- 1 Press [HOME].
- 2 Press [OK] to select "Setup".
- 3 Select "Player Settings".

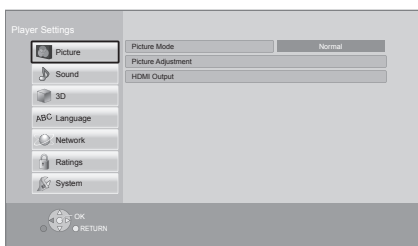

- 4 Select an item and change the settings.

To exit the screen

Press [HOME].

Picture

■ **Picture Mode**  (⇒ 25)

■ **Picture Adjustment**  (⇒ 25)

■ HDMI Output

Press [OK] to show the following settings:

➤ HDMI Video Format

The items supported by the connected devices are indicated on the screen as "*". When any item without "*" is selected, the images may be distorted.

- If "Automatic" is selected, the best suited output resolution to the connected TV is automatically selected.
- To enjoy high-definition video up-converted to 1080p, you need to connect the unit directly to 1080p compatible HDTV (High Definition TV). If this unit is connected to an HDTV through other equipment, the other equipment must also be 1080p compatible.

➤ 24p(4K)/24p Output

This setting is for selecting the output method for content recorded in 24p*, such as movies.

24p(4K)	Outputs signals by upconverting them to 4K*2.
24p	Outputs in 24p.

- Connect the compatible TV for each (4K or 1080/24p) output to the HDMI AV OUT MAIN **BDT465** **BDT460** /HDMI AV OUT **BDT365** **BDT364** **BDT363** **BDT361** **BDT360** terminal of this unit.
- "24p(4K)" works only when playing back in 2D.
- When playing DVD-Video, set this setting to "24p(4K)" or "24p", and then "24p" in "Picture Settings" (⇒ 25) to "On".
- When BD-Video/DVD-Video images other than 24p are played, images are output at 60p.

➤ HDMI Colour Mode

This setting is for selecting colour-space conversion of the image signal.

➤ Deep Colour Output

This setting is for selecting whether to use Deep Colour Output when a TV that supports Deep Colour is connected.

➤ Contents Type Flag

Depending on the playback content, the TV will output adjusting to the optimal method when a TV that supports this function is connected.

➤ HDMI(SUB) Output Mode BDT465 BDT460

Set to output the video from the HDMI AV OUT SUB terminal or not.

¹ A progressive image recorded at a rate of 24 frames per second (motion-picture film). Many BD-Video movie contents are recorded in 24 frames/second in accordance with the film materials.

² A high resolution image/display technology of approximately 4000 (width) × 2000 (height) pixels.

Sound

■ Dynamic Range Compression

You can listen at low volumes but still hear dialogue clearly.

(Dolby Digital, Dolby Digital Plus and Dolby TrueHD only)

- "Automatic" is effective only when playing Dolby TrueHD.

■ Digital Audio Output

Press [OK] to show the following settings:

➤ Dolby D/Dolby D +/Dolby TrueHD

➤ DTS/DTS-HD

Select the audio signal to output.

- Select "PCM", when the connected equipment cannot decode the respective audio format. This unit decodes the audio format and transmits to the connected equipment.
- If you do not make proper settings the audio may be static or noisy.

➤ BD-Video Secondary Audio

Select whether or not to mix the primary and secondary audio (including the button click sound).

If "Off" is selected, the unit outputs the primary audio only.

➤ HDMI Audio Output

This setting selects whether or not to output audio from HDMI.

- Select "Off" when the TV is connected to this unit via HDMI AV OUT terminal, and this unit is also connected to other devices, such as an amplifier/receiver via an OPTICAL terminal.

■ PCM Down Conversion

Select how to output audio with a sampling frequency of 96 kHz for the PCM output from the OPTICAL.

- If "On" is selected, the signals that are converted to 48 kHz are output.
- If "Off" is selected, and the connected equipment does not support 96 kHz, the sound will not be output normally.
- Signals are converted to 48 kHz despite the settings in the following cases:
 - when the signals have a sampling frequency of 192 kHz
 - when the disc has copy protection
 - when "BD-Video Secondary Audio" is set to "On"

■ Downmix

Select the downmix system of multi-channel to 2-channel sound.

- Select "Surround encoded", when the connected equipment supports the virtual surround function.
- The downmix effect is not available when "Digital Audio Output" is set to "Bitstream".
- The audio will be output in "Stereo" in the following cases:
 - AVCHD playback
 - Playback of secondary audio (including the button click sound).

■ DTS Neo:6

2ch (2.1ch) audio is expanded to 7ch (7.1ch).

- This function works when the following conditions are met:
 - Audio is output from the HDMI AV OUT terminal.
 - Audio recorded at 96 kHz or lower is output.
 - "Digital Audio Output" is set to "PCM" when audio other than PCM is output.

3D

■ 3D BD-Video Playback

Select the playback method of 3D compatible video software.

■ 3D AVCHD Output [BDT465] [BDT460]

Select the output method of 3D AVCHD videos.

■ 3D Playback Message

Set to display or hide the 3D viewing warning screen when playing back the 3D compatible video software.

■ Graphic Display Level (⇒ 25)

Language

■ Soundtrack Preference

Choose the language for audio.

- If "Original" is selected, the original language of each disc will be selected.
- Enter a code (⇒ 37) when you select "Other *****".

■ Subtitle Preference

Choose the language for the subtitle.

- If "Automatic" is selected and the language selected for "Soundtrack Preference" is not available, subtitles of that language will automatically appear if available on that disc.
- Enter a code (⇒ 37) when you select "Other *****".

■ Menu Preference

Choose the language for the disc menus.

- Enter a code (⇒ 37) when you select "Other *****".

■ Subtitle Text

Select a desired item according to the language used for MKV/Xvid subtitles text.

- This item is displayed only after playing back a file.

■ On-Screen Language

Choose the language for menus and on-screen messages.

Network

■ Easy Network Setting (⇒ 13)

■ Network Settings

Perform network-related settings individually. Press [OK] to show the following settings:

➤ LAN Connection Mode

Select the LAN connection method.

- Select "Wireless Master" when you make a direct wireless connection between this unit and a Home Network device. Internet connection is not available when this item is selected.

➤ Wireless Settings

This allows the wireless router and connection settings to be set up. Current connection settings and connection state can be checked. Press [OK] to show the following settings:

Connection Setting

The wireless router connection wizard will be displayed.

Double Speed Mode Setting (2.4GHz)

Set the connection speed for a 2.4 GHz wireless format.

- If you connect using the "Double Speed Mode (40MHz)", 2 channels use the same frequency band, and there is consequently a greater risk of reception interference. This can cause the connection speed to drop or become unstable.

➤ IP Address / DNS Settings

This is for checking the state of the network connection and setting the IP address and DNS-related.

Press [OK] to show the respective setting.

➤ Proxy Server Settings

This is for checking the state of connection with the Proxy server and performing settings.

Press [OK] to show the respective setting.

➤ Network Service Settings (⇒ 20)

Press [OK] to show the following settings:

Time Zone

Set the unit's time to match your location.

- Some Network Service contents require the time zone to be set. Set time zone if necessary.

Summer Time

Select "On" when using summer time.

➤ Network Drive Connection

It is possible to access the shared folder of equipment not compatible with DLNA, such as the Windows XP operating system, and play back video, still pictures, and music on this unit. For the setting and operation method of connected equipment, refer to the following website.

<http://panasonic.jp/support/global/cs/>
(This site is in English only.)

➤ Remote Device Settings (⇒ 20, 22)

Press [OK] to show the following settings:

Remote Device Operation

Enable to operate the unit by DMC, etc.

- If "On" is selected, "Quick Start" will be activated.

Device Name Entry

Set the name of this unit to be displayed on the connected equipment.

Registration Type

Automatic	Allow connections to all the equipment accessing this unit.
Manual	Set the permission for individual equipment connections accessing this unit.

Remote Device List

Registering/deregistering of the displayed equipment can be performed when "Manual" in "Registration Type" is selected.

➤ BD-Live Internet Access (⇒ 19)

You can restrict Internet access when BD-Live functions are used.

- If "Limit" is selected, Internet access is permitted only for BD-Live contents which have content owner certificates.

Ratings

The following items use the same password. Don't forget your password.

■ DVD-Video Ratings

Set a ratings level to limit DVD-Video play.

■ BD-Video Ratings

Set an age limit of BD-Video play.

■ Network Service Lock

You can restrict the usage of Network Service.

System**■ Easy Settings**

You can execute basic settings.



■ TV Settings

Press [OK] to show the following settings:

➤ TV Aspect

Set to match the type of TV connected.

When connected to a 4:3 aspect TV and playing 16:9 ratio image:

4:3 Pan & Scan	The sides are cut off so the picture fills the screen. When playing BD-Video, video is output as "4:3 Letterbox".	
4:3 Letterbox	Black bands appear at the top and bottom of the picture.	

When connected to a 16:9 widescreen TV and playing 4:3 ratio image:

16:9	Video is displayed as a 4:3 ratio image in the centre of the screen.
16:9 full	Video is displayed as a horizontally stretched 16:9 image.

➤ TV System

Perform the setup so it matches the TV System of the connected TV.

➤ Screen Saver Function

This is to prevent image retention on the screen.

- When this is set to “On”:
If a list of playback content is displayed and there is no operation for 10 minutes or more, the screen switches to HOME menu automatically.
- While playing and pausing, etc., this function is not available.

➤ On-Screen Messages

Choose whether to show status messages automatically.

➤ HDMI CEC

Set to use “HDMI CEC” function when connected via HDMI cable to a device that supports “HDMI CEC”.

- Select “Off” when you do not want to use “HDMI CEC”.

■ Unit Settings

Press [OK] to show the following settings:

➤ Mixed Data Disc Option

Select the playback contents on discs with both data files and Video.

- If “MP3/JPEG/MKV” is selected, data file can be played back.
- If “BD-DAV/AVCHD” is selected, BDAV and AVCHD can be played back.

➤ Front Panel Display

Changes the brightness of the unit’s display.

- If “Automatic” is selected, the display is set to bright and only dimmed during playback.

➤ Blue LED BDT465 BDT460

Set whether to light the blue LED in the centre of this unit when turned ON.

➤ HDMI(SUB) V.OFF LED Control

BDT465 BDT460

Set to light the HDMI (SUB) V.OFF LED or not.

- This will light when “HDMI(SUB) Output Mode” (⇒ 27) is set to “V.OFF(Video Off)”.

➤ Edit User Information

Change the user information registered in the HOME menu.

■ Start-up Banner

Select whether to display the banner after turning on this unit. (⇒ 16)

■ Quick Start

Speed of start-up from standby mode is increased.

- When set to “On”, the internal control unit will be powered and the idle power consumption will increase so compared to when set to “Off”. (Power consumption ⇒ 36)

■ Remote Control

Change the remote control code if other Panasonic products react to this remote control.

■ Firmware Update (⇒ 14)

Press [OK] to show the following settings:

➤ Automatic Update Check

When this equipment remains connected to the Internet, it will check for the latest firmware version when it is turned on and you can update it if necessary.

➤ Update Now

You can update the firmware manually if a firmware update is available.

■ System Information

Press [OK] to show the following settings:

➤ Software Licence

Information about the software used by this unit is displayed.

➤ Firmware Version Information

Display firmware version of this unit and wireless LAN module.

■ Default Settings

This returns all values in the Setup menu and the Option menu to the default settings, except for some settings of network, ratings, remote control code, on-screen language, etc.

Troubleshooting guide

Before requesting service, please perform the following checks.

If the problem remains unresolved, consult your dealer for instructions.

■ Unit does not respond to remote control or unit's buttons.

Disconnect the AC mains lead, wait 1 minute, then reconnect the AC mains lead.

Do you have the latest firmware installed?

Panasonic is constantly improving the unit's firmware to ensure that our customers are enjoying the latest technology. (⇒ 14)

The following do not indicate a problem with this unit:

- Regular disc rotating sounds.
- Image disturbance during search.
- Image disturbance when replacing 3D discs.

■ Cannot eject disc.

- ① Turn the unit on.
- ② Press and hold [OK], the yellow button and the blue button on the remote control at the same time for more than 5 seconds.
 - "00 RET" is displayed on the unit's display.
- ③ Press [▶] (right) repeatedly on the remote control until "06 FTO" is displayed on the unit's display.
- ④ Press [OK].

General operation

To return to the factory defaults.

- Select "Yes" in "Default Settings" in the Setup menu. (⇒ 30)

To return all settings to the factory preset.

- Reset the unit as follows:
 - ① Turn the unit on.
 - ② Press and hold [OK], the yellow button and the blue button on the remote control at the same time for more than 5 seconds.
 - "00 RET" is displayed on the unit's display.
 - ③ Press [▶] (right) repeatedly on the remote control until "08 FIN" is displayed on the unit's display.
 - ④ Press and hold [OK] for more than 5 seconds.

The remote control does not work properly.

- Change the batteries in the remote control. (⇒ 5)
- The remote control and this unit are using different codes.
 - If "SET □" is displayed on the unit's display when a button is pressed on the remote control, change the code on the remote control.
 - Press and hold [OK] and the displayed number ("□") for more than 5 seconds.

The TV tuner mode is not displayed when the TV is turned on.

- This phenomenon may occur, depending on the TV setting, when "Quick Start" is set to "On".
- Depending on the TV, this phenomenon may be prevented by reconnecting the HDMI cable to a different HDMI input terminal or by changing the HDMI auto connection setting.

You have forgotten your ratings password. You want to cancel the ratings level.

- The ratings level returns to the factory defaults.
 - ① Turn the unit on.
 - ② Press and hold [OK], the yellow button and the blue button on the remote control at the same time for more than 5 seconds.
 - "00 RET" is displayed on the unit's display.
 - ③ Press [▶] (right) repeatedly on the remote control until "03 VL" is displayed on the unit's display.
 - ④ Press [OK].

The TV screen turns black.

- In the following cases, HDMI authentication takes place and a black screen is displayed:
 - When "24p(4K)/24p Output" is set to "24p(4K)" or "24p".
 - When the display is switched between 2D and 3D images.
 - **BDT465** **BDT460** When you quit the 4K playback of a still picture by displaying another screen, including the HOME menu.

This unit does not recognize the USB connection correctly.

- Disconnect and re-connect the USB cable. If it still does not recognize the connection, turn this unit off and on again.
- USB devices may not be recognized by this unit when connected using the following :
 - a USB hub
 - a USB extension cable

- If you connect USB HDD to this unit, use the USB cable that is supplied with the HDD.
- When you connect a USB HDD, use the right USB port (USB2). (⇒ 15)

Picture

The images from this unit do not appear on the TV.

Picture is distorted.

- An incorrect resolution is selected in "HDMI Video Format". Reset the setting as follows:
 - ① Turn the unit on.
 - ② Press and hold [OK], the yellow button and the blue button on the remote control at the same time for more than 5 seconds.
 - "00 RET" is displayed on the unit's display.
 - ③ Press [▶] (right) repeatedly on the remote control until "04 PRG" is displayed on the unit's display.
 - ④ Press and hold [OK] for more than 5 seconds.
 - Set the item again. (⇒ 26)
 - When Dolby Digital Plus, Dolby TrueHD, and DTS-HD® audio are not output properly, select "Yes" in "Default Settings" (⇒ 30) and make proper settings.
- The unit and TV are using different video systems.
 - ① Turn the unit on.
 - ② Press and hold [OK], the yellow button and the blue button on the remote control at the same time for more than 5 seconds.
 - "00 RET" is displayed on the unit's display.
 - ③ Press [▶] (right) repeatedly on the remote control until "05 P/N" is displayed on the unit's display.
 - ④ Press and hold [OK] for more than 5 seconds.
 - The system switches from PAL to NTSC or vice versa.
- PAL discs cannot be correctly viewed on an NTSC TV.
- When "3D BD-Video Playback" in the Setup menu is set to "Automatic", images may not be output depending on the connection method. After removing the disc from this unit, select "Set before play" in the Setup menu, and select "2D Playback" in the setup screen displayed when playing 3D discs. (⇒ 28)

- When outputting in 24p (4K), images may be distorted depending on the HDMI cable. Use an HDMI cable that supports 4K output.

Video is not output. [BDT465] [BDT460]

- Video from the HDMI AV OUT SUB terminal is not output when the "HDMI(SUB) Output Mode" is set to "V.OFF(Video Off)". (⇒ 27)

Video is not output in high-definition.

- Confirm that "HDMI Video Format" in the Setup menu is set properly. (⇒ 26)

3D video is not output.

- Connect to a full high-definition TV.
- Is there a non-3D compatible amplifier/receiver connected between this unit and a TV? (⇒ 10)
- [BDT465] [BDT460] If there is a non-3D compatible amplifier/receiver connected to the HDMI AV OUT SUB terminal, set the "HDMI(SUB) Output Mode" to "V.OFF(Video Off)". (⇒ 11)
- Are the settings on this unit and the TV correct? (⇒ 19)
- Is the amplifier/receiver that is connected between this unit and TV on?
- Depending on the connected TV, the video being played back might switch to 2D video due to changes in resolution etc. Check the 3D setting on the TV.

3D video is not output correctly as 2D.

- Select "Set before play" in the Setup menu, and select "2D Playback" in the setup screen displayed when playing 3D discs. (⇒ 28, "3D BD-Video Playback")
- Discs that have recorded titles with Side by side (2 screen structure) and that can be enjoyed in 3D are played back in accordance with the settings of the TV.

A black band is displayed around the edge of the screen.

The aspect ratio of the screen is abnormal.

- Confirm the "TV Aspect" is set properly. (⇒ 29)
- Adjust the aspect setting on the TV.

Audio

Cannot switch audio.

- The audio cannot switch, if “Digital Audio Output” is set to “Bitstream”. Set “Digital Audio Output” to “PCM”. (⇒ 27)

Cannot hear the desired audio type.

- Check the connections and the “Digital Audio Output” settings. (⇒ 10, 27)
- **BDT465** **BDT460** When connecting this unit to a TV via an HDMI AV OUT MAIN and to an amplifier/receiver via an HDMI AV OUT SUB, set “HDMI(SUB) Output Mode” to “V.OFF(Video Off)”. (⇒ 11)
- To output audio from a device connected with an HDMI cable, set “HDMI Audio Output” to “On” in the Setup menu. (⇒ 27)

There is no sound coming out from the TV.

BDT465 **BDT460**

- Audio may not output from the TV when the amplifier/receiver is connected to the HDMI AV OUT SUB, and “HDMI(SUB) Output Mode” (⇒ 27) is set to “V.OFF(Video Off)”. In such a case, output audio from the amplifier/receiver. To output audio from the TV, set the “HDMI(SUB) Output Mode” to “Normal”.

Playback

Disc cannot be played.

- The disc is dirty. (⇒ 5)
- The disc is not finalized. (⇒ 7)
- Confirm the “Mixed Data Disc Option” is set properly. (⇒ 30)

Still pictures (JPEG) do not play back normally.

- The images that were edited on the PC, such as Progressive JPEG, etc., may not be played back.

I can't play back BD-Live.

- Confirm that this unit is connected to the broadband Internet. (⇒ 12)
- Confirm the “BD-Live Internet Access” settings. (⇒ 29)
- Confirm a USB device is connected to the USB port. (⇒ 15)
- Connect this unit to the network by a wired connection.

Network

I can't connect to the network.

- Confirm the network connection and settings. (⇒ 12, 13, 28)
- There may be interference that prevents the unit from detecting your home network. Place the unit and the wireless router closer to each other. This unit may be able to detect your network name (⇒ 13, "SSID").
- Check the operating instructions for each device and connect accordingly.

When using wireless LAN connection, video from the DLNA Certified media server is not played back or video frames are dropped during playback.

- Higher transfer rate router such as 802.11n (2.4 GHz or 5 GHz) wireless router may solve the problem. If you use 802.11n (2.4 GHz or 5 GHz) wireless router, it is necessary to set the encryption type to "AES".
Simultaneous use with a microwave, cordless telephone etc. at 2.4 GHz may result in connection interruptions or other problems.
- On the "Wireless Settings" screen (⇒ 28), the continuous lighting of at least 4 "Reception" indicators is the target for a stable connection. If 3 or fewer indicators are lit or the connection is being interrupted, change the position or angle of your wireless router and see if the connection state improves. If there is no improvement, connect to a wired network and perform the "Easy Network Setting" (⇒ 13) again.

Messages on the screen

Cannot play.

- You inserted an incompatible disc.

Cannot play on this unit.

- You tried to play a non-compatible image.
- Re-insert the media.

No disc inserted.

- The disc may be upside down.

⊗ This operation is not available.

- Some operations are unsupported by the unit. (For example, reverse slow motion, etc.)

IP address is not set.

- The "IP Address" in "IP Address / DNS Settings" is "----. ---. ---. ---". Set the "IP Address", "Subnet Mask", and "Gateway Address". (Select the automatic address acquisition if necessary.)

The wireless access point currently has a low network security setting. It is recommended to change to a higher setting.

- Set a stronger network security level referring to the wireless router operating instructions.

Messages on the unit's display

NET

- While connecting to a network.

No PLAY

- There is a viewing restriction on a BD-Video or DVD-Video. (⇒ 29)
- The media is dirty or badly scratched. The unit cannot play.

REMOVE

- The USB device is drawing too much power. Remove the USB device.

SET □

("□" stands for a number.)

- The remote control and this unit are using different codes. Change the code on the remote control.

Press and hold [OK] and the indicated number

button at the same time for more than 5 seconds.



U59

- Temperature of this unit is hot and the unit switches to standby for safety reasons. Wait for about 30 minutes. Install or place this unit with good ventilation.

H□□ or F□□

("□" stands for a number.)

- There is something unusual.
- Check the unit using the troubleshooting guide. If the service number remains displayed, do the following.
 - ① Disconnect the plug from the household mains socket, wait a few seconds, then reconnect it.
 - ② Press [⏻/|] to turn the unit on.

If the service number remains displayed despite doing the above, request service from the dealer.

Inform the dealer of the service number when requesting service.

START

- The system is being restarted during the firmware update. Please do not turn off the unit.

UPD□/□

("□" stands for a number.)

- The firmware is being updated. Please do not turn off the unit.

FIN

- The firmware update is complete.

Specifications

General

Signal system	PAL/NTSC
Operating temperature range	+5 °C to +35 °C
Operating humidity range	10 % to 80 % RH (no condensation)
Digital audio output	Optical digital output (Optical terminal)
HDMI AV output	Output connector: BDT465 BDT460 Type A (19 pin) 2 system BDT365 BDT364 BDT363 BDT361 BDT360 Type A (19 pin) 1 system
BDT465 BDT460 SD card slot	1 system
USB slot	USB2.0: 2 system
Ethernet	10BASE-T/100BASE-TX 1 system
Wireless LAN	Standard Compliance: IEEE802.11 a/b/g/n Frequency range: 2.4 GHz/5 GHz band Security: WPA™/WPA2™ (Encryption Type: TKIP/AES, Authentication Type: PSK), WEP (64 bit/128 bit)
LASER Specification	Class 1 LASER Product Wave length: 785 nm (CDs)/ 660 nm (DVDs)/405 nm (BDs) Laser power: No hazardous radiation is emitted with the safety protection
Power supply	AC 220 V to 240 V, 50 Hz
Power consumption	Approx. 18 W
Power consumption in standby mode	Approx. 0.5 W
Power consumption in quick start standby mode	BDT465 BDT460 Approx. 6 W BDT365 BDT364 BDT363 BDT361 BDT360 Approx. 5.5 W
Dimensions (W×H×D)	Approx. 415 mm×43 mm×182 mm
Mass	Approx. 1.2 kg

- Specifications are subject to change without notice.

File format

File format	Extension	Reference
MKV	“.MKV”, “.mkv”	<ul style="list-style-type: none"> • The video file and subtitles text file are inside the same folder, and the file names are the same except for the file extensions. • Some MKV/Xvid files may not be played back correctly, depending on the video resolution, frame rate condition, subtitle format and so on.
	Subtitles text file “.SRT”, “.srt”, “.SSA”, “.ssa”, “.ASS”, “.ass”	
Xvid	“.AVI”, “.avi”	<ul style="list-style-type: none"> • Some MKV/Xvid files may not be played back correctly, depending on the video resolution, frame rate condition, subtitle format and so on.
	Subtitles text file “.SRT”, “.srt”, “.SUB”, “.sub”, “.TXT”, “.txt”	
mp4 (H.264+AAC)	“.MP4”, “.mov”	Some mp4/MPEG files may not be played back correctly, depending on the video resolution, frame rate condition and so on.
MPEG (TS/PS)	“.mpg”, “.mpeg”, “.m2ts”, “.mts”, “.ts”	
JPEG	“.JPG”, “.jpg”, “.jpeg”	<ul style="list-style-type: none"> • MOTION JPEG and Progressive JPEG are not supported. • You may not be able to play back the file if you have edited the folder structure or the file name on a PC or other device.
MP3	“.MP3”, “.mp3”	This unit supports ID3 tags, but only titles, artist names and album names can be displayed.
FLAC	“.FLAC”, “.flac”	Maximum sampling rate: 192 kHz/24 bit
WAV	“.WAV”, “.wav”	Maximum sampling rate: 192 kHz/24 bit
MPO	“.MPO”, “.mpo”	3D still picture
AAC	“.M4A”, “.m4a”, “.AAC”, “.aac”	This unit supports ID3 tags. Maximum sampling rate: 48 kHz/320 kbps
WMA	“.WMA”, “.wma”	This unit supports ID3 tags. Maximum sampling rate: 48 kHz/355 kbps

- With certain recording states and folder structures, the play order may differ or playback may not be possible.

Audio information

The audio output differs depending on which terminals are connected to the amplifier/receiver, and the settings on the unit. (⇒ 27, "Digital Audio Output")

- The number of channels listed is the maximum possible number of output channels when connected to amplifier/receiver compatible with the respective audio format.

	Terminal	"Digital Audio Output"	
		"Bitstream"	"PCM"
Output channel	HDMI AV OUT ²	Outputs using original audio ¹	BD-Video : 7.1ch PCM ¹ DVD-Video : 5.1ch PCM
	OPTICAL	Dolby Digital/ DTS Digital Surround™	Down-mixed 2ch PCM

¹ When "BD-Video Secondary Audio" is set to "On", the audio will be output as Dolby Digital, DTS Digital Surround™ or 5.1ch PCM.

² When "DTS Neo:6" is set to "Cinema" or "Music", 2ch (2.1ch) audio can be expanded to 7ch (7.1ch) and output. (⇒ 27)

Supported format for DLNA

- File formats that are not supported by your DLNA server cannot be played.

Video

Container	Video codec	Audio codec	Example of file extension
MKV	H.264	AAC DTS® PCM FLAC Vorbis	.mkv
Xvid*	MPEG-4 Advanced Simple Profile (ASP)		
AVCHD	H.264	Dolby Digital	.mts
MP4		AAC	.mp4, .mov
PS	MPEG2	Dolby Digital Linear PCM	.mpg, .mpeg
TS	MPEG2 H.264	AAC Dolby Digital	.m2ts, .ts

Photo

Format	Example of file extension
JPEG	.jpg, .jpeg

Audio

Audio codec	Example of file extension
MP3	.mp3
FLAC	.flac
AAC	.m4a, .aac
WMA	.wma
Linear PCM	—

* Only when the file is transcoded by DLNA server.

Display languages list

Display Language	Display Language	Display Language
ENG English	JPN Japanese	ARA Arabic
FRA French	CHI Chinese	HIN Hindi
DEU German	KOR Korean	PER Persian
ITA Italian	MAL Malay	IND Indonesian
ESP Spanish	VIE Vietnamese	MRI Maori
NLD Dutch	THA Thai	BUL Bulgarian
SVE Swedish	POL Polish	RUM Romanian
NOR Norwegian	CES Czech	GRE Greek
DAN Danish	SLK Slovak	TUR Turkish
POR Portuguese	HUN Hungarian	* Others
RUS Russian	FIN Finnish	

Language code list

Language	Code	Language	Code	Language	Code
Abkhazian:	6566	Gujarati:	7185	Rhaeto-Romance:	
Afar:	6565	Hausa:	7265		8277
Afrikaans:	6570	Hebrew:	7387	Romanian:	8279
Albanian:	8381	Hindi:	7273	Russian:	8285
Amharic:	6577	Hungarian:	7285	Samoan:	8377
Arabic:	6582	Icelandic:	7383	Sanskrit:	8365
Armenian:	7289	Indonesian:	7378	Scots Gaelic:	7168
Assamese:	6583	Interlingua:	7365	Serbian:	8382
Aymara:	6589	Irish:	7165	Serbo-Croatian:	8372
Azerbaijani:	6590	Italian:	7384	Shona:	8378
Bashkir:	6665	Japanese:	7465	Sindhi:	8368
Basque:	6985	Javanese:	7487	Singhalese:	8373
Bengali; Bangla:	6678	Kannada:	7578	Slovak:	8375
	6678	Kashmiri:	7583	Slovenian:	8376
Bhutani:	6890	Kazakh:	7575	Somali:	8379
Bihari:	6672	Kirghiz:	7589	Spanish:	6983
Breton:	6682	Korean:	7579	Sundanese:	8385
Bulgarian:	6671	Kurdish:	7585	Swahili:	8387
Burmese:	7789	Laotian:	7679	Swedish:	8386
Byelorussian:	6669	Latin:	7665	Tagalog:	8476
Cambodian:	7577	Latvian, Lettish:	7686	Tajik:	8471
Catalan:	6765	Lingala:	7678	Tamil:	8465
Chinese:	9072	Lithuanian:	7684	Tatar:	8484
Corsican:	6779	Macedonian:	7775	Telugu:	8469
Croatian:	7282	Malagasy:	7771	Thai:	8472
Czech:	6783	Malay:	7783	Tibetan:	6679
Danish:	6865	Malayalam:	7776	Tigrinya:	8473
Dutch:	7876	Maltese:	7784	Tonga:	8479
English:	6978	Maori:	7773	Turkish:	8482
Esperanto:	6979	Marathi:	7782	Turkmen:	8475
Estonian:	6984	Moldavian:	7779	Twi:	8487
Faroese:	7079	Mongolian:	7778	Ukrainian:	8575
Fiji:	7074	Nauru:	7865	Urdu:	8582
Finnish:	7073	Nepali:	7869	Uzbek:	8590
French:	7082	Norwegian:	7879	Vietnamese:	8673
Frisian:	7089	Oriya:	7982	Volapük:	8679
Galician:	7176	Pashto, Pushto:	8083	Welsh:	6789
Georgian:	7565	Persian:	7065	Wolof:	8779
German:	8869	Polish:	8076	Xhosa:	8872
Greek:	6976	Portuguese:	8084	Yiddish:	7473
Greenlandic:	7576	Punjabi:	8065	Yoruba:	8979
Guarani:	7178	Quechua:	8185	Zulu:	9085

"AVCHD", "AVCHD 3D", "AVCHD Progressive" and "AVCHD 3D/ Progressive" are trademarks of Panasonic Corporation and Sony Corporation.

Java is a registered trademark of Oracle and/or its affiliates.

Manufactured under license from Dolby Laboratories. Dolby and the double-D symbol are trademarks of Dolby Laboratories.

For DTS patents, see <http://patents.dts.com>. Manufactured under license from DTS Licensing Limited. DTS, DTS-HD, the Symbol, & DTS and the Symbol together are registered trademarks, and DTS-HD Master Audio is a trademark of DTS, Inc. © DTS, Inc. All Rights Reserved.

HDMI, the HDMI Logo, and High-Definition Multimedia Interface are trademarks or registered trademarks of HDMI Licensing LLC in the United States and other countries.

This product is licensed under the AVC patent portfolio license and VC-1 patent portfolio license for the personal and non-commercial use of a consumer to (i) encode video in compliance with the AVC Standard and VC-1 Standard ("AVC/VC-1 Video") and/or (ii) decode AVC/VC-1 Video that was encoded by a consumer engaged in a personal and non-commercial activity and/or was obtained from a video provider licensed to provide AVC/VC-1 Video. No license is granted or shall be implied for any other use. Additional information may be obtained from MPEG LA, LLC. See <http://www.mpegla.com>.

MPEG Layer-3 audio coding technology licensed from Fraunhofer IIS and Thomson.

SDXC Logo is a trademark of SD-3C, LLC.

"DVD Logo" is a trademark of DVD Format/Logo Licensing Corporation.

The Wi-Fi CERTIFIED Logo is a certification mark of the Wi-Fi Alliance.
The Wi-Fi Protected Setup Mark is a mark of the Wi-Fi Alliance.

"Wi-Fi", "Wi-Fi Protected Setup", "Wi-Fi Direct", "Miracast", "WPA" and "WPA2" are marks or registered marks of the Wi-Fi Alliance.

DLNA, the DLNA Logo and DLNA CERTIFIED are trademarks, service marks, or certification marks of the Digital Living Network Alliance.

Windows is a trademark or a registered trademark of Microsoft Corporation in the United States and other countries.

Android is a trademark of Google Inc.

Copyright 2004-2013 Verance Corporation. Cinavia™ is a Verance Corporation trademark. Protected by U.S. Patent 7,369,677 and worldwide patents issued and pending under license from Verance Corporation. All rights reserved.

This product incorporates the following software:

- (1) the software developed independently by or for Panasonic Corporation,
- (2) the software owned by third party and licensed to Panasonic Corporation,
- (3) the software licensed under the GNU General Public License, Version 2.0 (GPL V2.0),
- (4) the software licensed under the GNU LESSER General Public License, Version 2.1 (LGPL V2.1), and/or
- (5) open source software other than the software licensed under the GPL V2.0 and/or LGPL V2.1.

The software categorized as (3) - (5) are distributed in the hope that it will be useful, but WITHOUT ANY WARRANTY, without even the implied warranty of MERCHANTABILITY or FITNESS FOR A PARTICULAR PURPOSE. Please refer to the detailed terms and conditions thereof shown in the Player Settings menu.

At least three (3) years from delivery of this product, Panasonic will give to any third party who contacts us at the contact information provided below, for a charge no more than our cost of physically performing source code distribution, a complete machine-readable copy of the corresponding source code covered under GPL V2.0, LGPL V2.1 or the other licenses with the obligation to do so, as well as the respective copyright notice thereof.

Contact Information: oss-cd-request@gg.jp.panasonic.com
The source code and the copyright notice are also available for free in our website below.
<http://panasonic.net/avc/oss/bdplayer/AWBPM14A.html>

David M. Gay's dtoa and strtod license

The author of this software is David M. Gay.

Copyright (c) 1991, 2000, 2001 by Lucent Technologies.

Permission to use, copy, modify, and distribute this software for any purpose without fee is hereby granted, provided that this entire notice is included in all copies of any software which is or includes a copy or modification of this software and in all copies of the supporting documentation for such software.

THIS SOFTWARE IS BEING PROVIDED "AS IS", WITHOUT ANY EXPRESS OR IMPLIED WARRANTY, IN PARTICULAR, NEITHER THE AUTHOR NOR LUCENT MAKES ANY REPRESENTATION OR WARRANTY OF ANY KIND CONCERNING THE MERCHANTABILITY OF THIS SOFTWARE OR ITS FITNESS FOR ANY PARTICULAR PURPOSE.

"UNICODE, INC. LICENSE AGREEMENT - DATA FILES AND SOFTWARE

Unicode Data Files include all data files under the directories <http://www.unicode.org/Public/>, <http://www.unicode.org/reports/>, and <http://www.unicode.org/cldr/data/>.

Unicode Software includes any source code published in the Unicode Standard or under the directories <http://www.unicode.org/Public/>, <http://www.unicode.org/reports/>, and <http://www.unicode.org/cldr/data/>.

NOTICE TO USER: Carefully read the following legal agreement. BY DOWNLOADING, INSTALLING, COPYING OR OTHERWISE USING UNICODE INC.'S DATA FILES ("DATA FILES"), AND/OR SOFTWARE ("SOFTWARE"), YOU UNEQUIVOCALLY ACCEPT, AND AGREE TO BE BOUND BY, ALL OF THE TERMS AND CONDITIONS OF THIS AGREEMENT. IF YOU DO NOT AGREE, DO NOT DOWNLOAD, INSTALL, COPY, DISTRIBUTE OR USE THE DATA FILES OR SOFTWARE.

COPYRIGHT AND PERMISSION NOTICE

Copyright (c) 1991-2009 Unicode, Inc. All rights reserved. Distributed under the Terms of Use in <http://www.unicode.org/copyright.html>.

Permission is hereby granted, free of charge, to any person obtaining a copy of the Unicode data files and any associated documentation (the "Data Files") or Unicode software and any associated documentation (the "Software") to deal in the Data Files or Software without restriction, including without limitation the rights to use, copy, modify, merge, publish, distribute, and/or sell copies of the Data Files or Software, and to permit persons to whom the Data Files or Software are furnished to do so, provided that (a) the above copyright notice(s) and this permission notice appear with all copies of the Data Files or Software, (b) both the above copyright notice(s) and this permission notice appear in associated documentation, and (c) there is clear notice in each modified Data File or in the Software as well as in the documentation associated with the Data File(s) or Software that the data or software has been modified.

THE DATA FILES AND SOFTWARE ARE PROVIDED "AS IS", WITHOUT WARRANTY OF ANY KIND, EXPRESS OR IMPLIED, INCLUDING BUT NOT LIMITED TO THE WARRANTIES OF MERCHANTABILITY, FITNESS FOR A PARTICULAR PURPOSE AND NONINFRINGEMENT OF THIRD PARTY RIGHTS. IN NO EVENT SHALL THE COPYRIGHT HOLDER OR HOLDERS INCLUDED IN THIS NOTICE BE LIABLE FOR ANY CLAIM, OR ANY SPECIAL INDIRECT OR CONSEQUENTIAL DAMAGES, OR ANY DAMAGES WHATSOEVER RESULTING FROM LOSS OF USE, DATA OR PROFITS, WHETHER IN AN ACTION OF CONTRACT, NEGLIGENCE OR OTHER TORTIOUS ACTION, ARISING OUT OF OR IN CONNECTION WITH THE USE OR PERFORMANCE OF THE DATA FILES OR SOFTWARE.

Except as contained in this notice, the name of a copyright holder shall not be used in advertising or otherwise to promote the sale, use or other dealings in these Data Files or Software without prior written authorization of the copyright holder."

(1) MS/WMA

This product is protected by certain intellectual property rights of Microsoft Corporation and third parties. Use or distribution of such technology outside of this product is prohibited without a license from Microsoft or an authorized Microsoft subsidiary and third parties.

(2) MS/PlayReady/Final Product Labeling

This product contains technology subject to certain intellectual property rights of Microsoft. Use or distribution of this technology outside of this product is prohibited without the appropriate license(s) from Microsoft.

(3) MS/PlayReady/End User Notices

Content owners use Microsoft PlayReady™ content access technology to protect their intellectual property, including copyrighted content. This device uses PlayReady technology to access PlayReady-protected content and/or WMDRM-protected content. If the device fails to properly enforce restrictions on content usage, content owners may require Microsoft to revoke the device's ability to consume PlayReady-protected content. Revocation should not affect unprotected content or content protected by other content access technologies. Content owners may require you to upgrade PlayReady to access their content. If you decline an upgrade, you will not be able to access content that requires the upgrade.

(4) FLAC, WPA Supplicant

The software licenses are displayed when "Software Licence" in the Setup menu is selected. (⇒ 30)



ADVARSEL**Produkt**

For å redusere faren for brann, elektrisk støt eller skade på apparatet:

- Utsett ikke produktet for regn, fukt, drypping eller sprut.
- Ikke plasser objekter som er fylt med væske, som vaser, på apparatet.
- Bruk kun anbefalt tilbehør.
- Fjern ikke deksler.
- Reparer ikke denne enheten selv, overlatt service til kvalifisert servicepersonell.

Vekselstrømnett

Nettstøpelet er trukket ut fra denne enheten.

Installer denne enheten slik at nettstøpelet umiddelbart kan trekkes fra stikkkontakten.

FORSIKTIG**Produkt**

- Dette produktet anvender en laser. Betjening av kontroller eller justering eller andre inngrep enn de beskrevet i denne bruksanvisning kan føre til farlig bestråling.
- Plasser ikke åpen ild, slik som levende lys, oppå apparatet.
- Dette apparatet er beregnet for bruk under moderate klimaforhold.

Plassering

For å redusere faren for brann, elektrisk støt eller skade på apparatet:

- Ikke plasser apparatet i en bokhylle, et innebygget kabinet eller et annet lukket sted. Pass på at produktet er godt ventilert.
- Apparatets ventilasjonsåpninger må ikke dekkes til med aviser, duker, gardiner eller lignende.

LASER-spesifikasjon**Klasse 1 LASER-produkt:**

Bølgelengde : 785 nm (CD)/660 nm (DVD)/405 nm (BD)

Laserstyrke : Ingen farlig stråling sendes ut

CAUTION – VISIBLE AND INVISIBLE LASER RADIATION WHEN OPEN. DO NOT STARE INTO BEAM. FDA 21CFRCLASS II (IIa)	(Inside of product)
CAUTION – CLASS 2 VISIBLE AND INVISIBLE LASER RADIATION WHEN OPEN. DO NOT STARE INTO THE BEAM. IEC60825-1:CLASS 2	(Produktets innside)
ATTENTION – RAYONNEMENT LASER VISIBLE ET INVISIBLE, CLASSE 2. EN CAS D'OUVERTURE, NE PAS REGARDER DANS LE FAISCEAU.	
FORSIKTIG – SYNLIG OG USYNLIG LASERSTRÅLING KLASSE 2, NÅR LÅGET ER ÅBENT. UNDGÅ ÅT SE LIGE IND I STRÅLEN.	
VARO – AVATTAESSA OLET ALLTIINA LUOKAN 2 NÄKYVÄÄ JA NÄKYMÄTÖNTÄ LASERSÄTELYÄ. ÄLÄ TUUJOTA SÄTEESEEN.	
WARNING – KLASSE 2 SYNLIG OCH OSYNLIG LASERSTRÅLNING NÄR DENNA DEL ÄR ÖPPNAD. STRÅLA EJ IN I STRÅLEN.	
VORSICHT – SICHTBARE UND UNSICHTBARE LASERSTRAHLUNG KLASSE 2. WENN ABDECKUNG GEÖFFNET, NICHT IN DEN STRAHL BLICKEN.	
注意 – 打开时有可见及不可见激光辐射。避免光束照射。	
注意 – ここを開くとクラス2の可視及び不可視レーザー放射が出る。ビームをのぞきまなはすと	VQL2P54



**LUOKAN 1 LASERLAITE
KLASS 1 LASER APPARAT**



Manufactured by: Panasonic Corporation
Kadoma, Osaka, Japan

Importer for Europe: Panasonic Marketing Europe GmbH
Panasonic Testing Centre
Winsbergring 15, 22525 Hamburg, Germany



Panasonic Corporation
Web Site: <http://panasonic.net>