

ORION

Instruction manual

22" DIGITAL LCD TELEVISION WITH DVD PLAYER

TV22PL145DVD

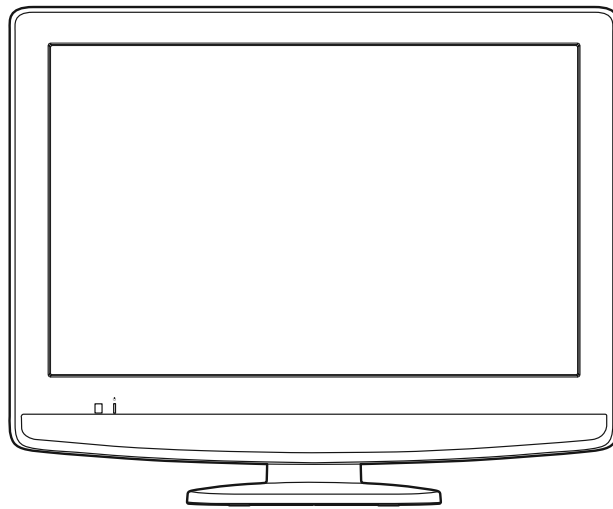

Accessories				
<p>Instruction manual</p>	<p>Quick Set-up guide</p>	<p>Remote control</p>	<p>Battery (R-6, AA) x 2</p>	<p>AC mains lead</p>

Before operating the unit, please read this manual thoroughly.

If you experience any difficulties or would like further assistance, please contact our Helpline on 020 8236 9090.

Please Note: This is for operating problems and NOT for Service or Technical enquiries.

Safety warnings

Contents

Connection and Analogue Channel Setup

Basic TV Features

Digital TV Operation

DVD Operations

Connection to Other Equipment

Fast finding guide and Specifications

Damage - Never use your TV if it is damaged in any way. Always place your TV on a flat level surface avoiding anywhere which may be subject to strong vibration.

Weather - It is advisable to unplug the aerial during an electrical storm.

Moisture - Do not allow your TV to be exposed to rain, moisture or dust.

If any liquid is spilt into your TV it can cause serious damage. If you spill any liquid into your TV switch it off at the mains immediately. Contact your store.

Interference

Do not place your TV on or near appliances which may cause electromagnetic interference (TV or Hi-Fi speakers). If you do, it may adversely affect the working of the unit, causing erratic playback, distorted picture or sound.

Temperature

Avoid extremes of temperature, either hot or cold, place your TV well away from heat sources such as radiators or gas/electric fires.

Ventilation

The TV must be well ventilated. Do not cover your TV or place inside a small confined space. It is recommended that you leave a 10cm gap all around your TV.

Covers - Do not remove any fixed covers as this may expose dangerous voltages.

Note:

- When installing the set on a wall, allow at least 10 cm clearance between the rear of the set and the wall. Clearance of less than 10 cm will obstruct the vents and cause the interior of the set to overheat, resulting in faults or damage to the set.
- If the unit is mounted on the wall, contact the shop where you purchased the unit for advice, and leave the installation work to experts. Incomplete installation work can cause you injuries.
- The apparatus must be connected to a mains socket outlet with a protective earthing connection.
- The socket outlet must be installed near the equipment and easily accessible.

* The "HD ready" Logo is a trademark of EICTA.

Standby

Do not leave your TV in standby for long periods of time e.g. overnight or while on holiday. We recommend that you switch off / unplug at the mains power supply.

Headphone

Loud music can damage your hearing irreversibly, therefore do not set the volume to a high level when listening through headphones, particularly for extended listening periods.

Batteries

- Batteries are easily swallowed by young children. Do not allow young children to play with the remote control unit.
- Valid in EU only: The crossed out wheelie bin symbol indicates that used batteries should not be disposed of with your normal household waste! A separate collection system for used batteries is in place to allow the correct treatment and recycling in accordance with current legislation. Please contact your local authority for details on collection and recycling schemes in your area.

CAUTION:

THIS UNIT IS A CLASS 1 LASER PRODUCT. HOWEVER THIS UNIT USES A VISIBLE LASER BEAM WHICH COULD CAUSE HAZARDOUS RADIATION EXPOSURE IF DIRECTED. BE SURE TO OPERATE THE PLAYER CORRECTLY AS INSTRUCTED. WHEN THIS UNIT IS PLUGGED INTO THE WALL OUTLET, DO NOT PLACE YOUR EYES CLOSE TO THE OPENINGS TO LOOK INTO THE INSIDE OF THIS UNIT. USE OF CONTROLS OR ADJUSTMENTS OR PERFORMANCE OF PROCEDURES OTHER THAN THOSE SPECIFIED HEREIN MAY RESULT IN HAZARDOUS RADIATION EXPOSURE. DO NOT OPEN COVERS AND DO NOT REPAIR YOURSELF. REFER SERVICING TO QUALIFIED PERSONNEL.

Plasma and LCD TV Screen Burn Warning

A characteristic of Plasma and LCD TV Panels is that displaying the same image for a long time may cause a permanent after-image to remain on the screen. This is called screen burn. Most pictures shown on your TV will be constantly moving and fill the screen.

Examples of images that you need to watch out for are as follows (this is not an all-inclusive list):

- **Black Bars:** If black bars appear at the left/right or top/bottom of the screen it is recommended to change the format so that the picture fills the entire screen.
- **TV Channel Logos:** e.g. Shopping channel logos and pricing displays - especially if they are bright and stationary. Moving or low-contrast graphics are less likely to cause ageing of the screen.
- **PIP and Multipip:** Do not view for long periods of time using the PIP or Multipip functions.
- **Time Displays**
- **Teletext:** Do not view a stationary page for long periods of time.
- **TV/DVD Menus:** e.g. Listings of DVD disk content.
- **Pause Mode:** Do not leave the screen in pause mode for long periods of time, e.g. When watching DVDs or videos.

Note: To prevent screen burn if viewing any of the above for long periods of time, reduce contrast and brightness when viewing. Once burn-in occurs it will never disappear completely.

Attention!

Cleaning instructions for your LCD TV.

Safety note:

Before you start to clean, switch the set's power off completely and disconnect the plug from the mains power supply.

Be careful not to scratch the plastic coated front panel - it is highly vulnerable to accidental scratching (e.g. by fingernails or other sharp items).

While cleaning, do not wear jewellery that could cause surface scratching (such as rings, wrist-watch, etc.).

Use a lint-free cloth and pure water to clean with, but make sure the cloth is thoroughly wrung out so that it is just damp and not soaking wet - also make sure that the cloth is free from any dirt that could cause scratching to the surface.

Wipe the set clean using minimal pressure.

Do not use standard window cleaning fluid. Its alcohol / ammonia will dissolve the front window's coating.

Never use solvent or thinner. Never use special cleaners which are designed for cleaning PC Monitors or CRT TVs.

Finally carefully rub dry with a clean dry lint-free cloth.

Do not use paper towels or tissues to clean the set - paper can disintegrate when wet or may leave a trail of dust behind. Some paper can also be abrasive and scratch your screen.



Moving the unit or carrying by hand

When the unit is moved a long way, unplug the power cord and disconnect the aerial, connecting leads and any fall-prevention apparatus.

- Moving without doing so could result in damage to the power cord, a fire, electric shocks or injuries from dropping the unit.

The distance between eyes and the screen should be about 5 ~ 7 times as long as diagonal length of the screen.

- Viewing from too close a distance can cause strain for your eyes.

When installing the Monitor on a table, be careful not to place the edge of its stand.

- This may cause the Monitor to fall, causing serious injury to a child or adult, and serious damage to the Monitor.

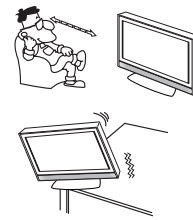

Contents

Connection and Analogue Channel Setup

Location of controlsPage 2

Aerial connectionPage 3

Auto setupPage 4

Quick guide for ANALOG MENU operation ...Page 5

Selecting the video input sourcePage 5

On-screen Language SelectionPage 5

Automatic station presetting with the built-in TunerPage 6

Changing the order of stored channelsPage 6

Manual TV station presettingPage 7

Basic TV Features

Basic TV functionsPage 8

TeletextPage 9

Stereo reception with the built-in analogue tunerPage 10

Picture formatPage 11

Other convenience functions.....Page 12

Digital TV Operations

Guide to using the Digital Menu SystemPage 13

Language SetupPage 14

Auto ScanPage 14

Manual ScanPage 15

Carrier SetupPage 15

Channel OrganizerPage 16

Display SetupPage 18

Password Setup (Parental lock)Page 18

VersionPage 19

Software Upgrade.....Page 19

Common Interface.....Page 19

Channel listPage 20

Channel bannerPage 20

Multi audio.....Page 21

DVB-Subtitle.....Page 21

EPG (Electronic Program Guide).....Page 22

EPG TimerPage 23

DVD Operations

Disc.....Page 24

Playing a disc.....Page 25

ZoomingPage 28

Locating desired scene.....Page 28

Marking desired scenesPage 29

Repeat playbackPage 30

A-B Repeat playbackPage 30

Changing anglesPage 31

Title selectionPage 31

DVD menu.....Page 31

Changing soundtrack languagePage 32

SubtitlesPage 32

Disc statusPage 32

MP3/WMA/JPEG and Audio CD operation..Page 33

Program playback.....Page 38

Random playback.....Page 38

Customizing The Function Settings.....Page 39

Temporary cancel the rating level by DVD disc.....Page 43

Language Code List.....Page 44

Connection to Other Equipment

PC connectionPage 45

Connecting an HDMI or a DVI device to the HDMI inputPage 46

Connection to other equipmentPage 47

Fault finding guide and Specifications

Fault finding guidePage 51

SpecificationsPage 53



Location of controls

Front Side

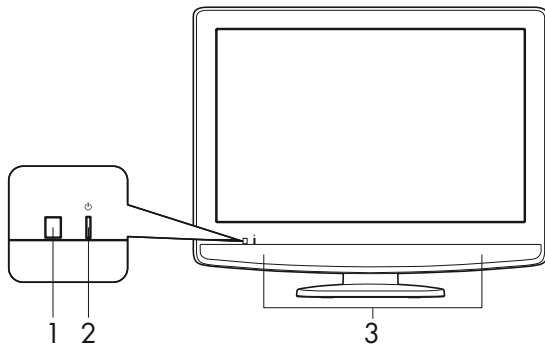

Left Side

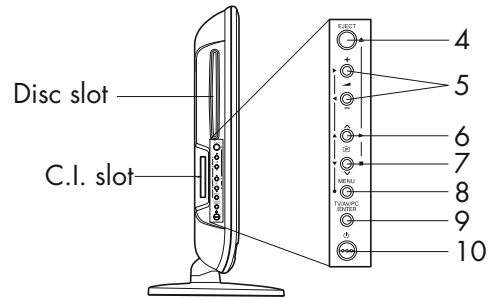

Description of Indicators and Controls

- 1. Remote sensor**
- 2. On/Timer/Standby indicator:** The LED indicator lights up red in STANDBY mode, green in the POWER ON mode.
- 3. Loudspeakers**
- 4. EJECT (▲):** Eject a disc.
- 5. ▲ (VOLUME) +/- Buttons:** To adjust the volume. When the Menu is on the screen, these are used for changing settings.
- 6. (P) (Channel) ^ / ▶ (PLAY) button:** Press ^ to change to a higher numbered channel set into memory. DVD mode : Playback. In Menu: Setting. In Standby: Turning on the unit.
- 7. (P) (Channel) v / ■ (STOP) button:** Press v to change to a lower numbered channel set into memory. DVD mode : Stop. In Menu: Setting. In Standby: Turning on the unit.
- 8. MENU Button:** To display the menu screen.
- 9. TV/AV/PC Button / ENTER button:** Selects between the TV/AV/PC input modes. In Menu: Setting.
- 10. (Power) button:** To switch between the STANDBY and POWER ON modes.

Remote Control

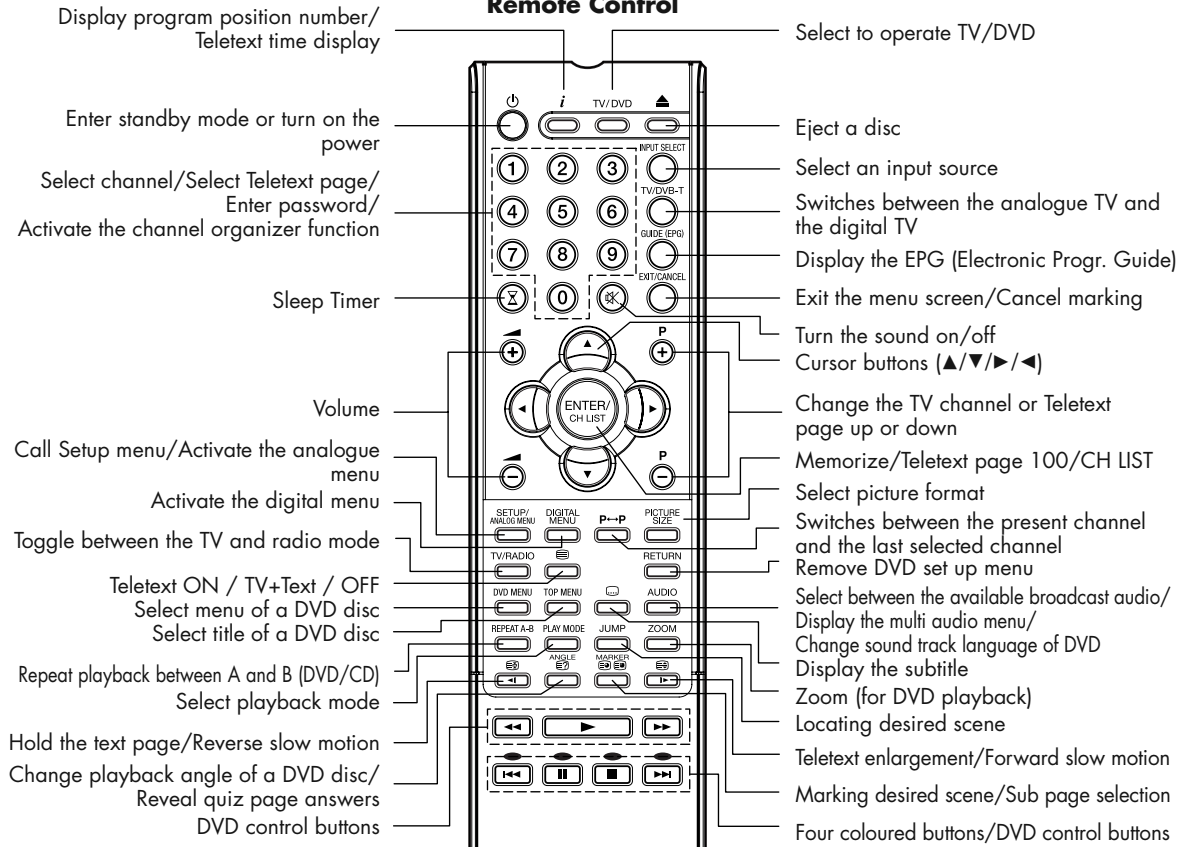

Aerial connection

Note: To avoid possible damage, before you make any connections, turn off the TV at the **⏻ (Power)** button and unplug it from the mains. Once the connections are in place, re-connect the unit to the mains and switch it back on.

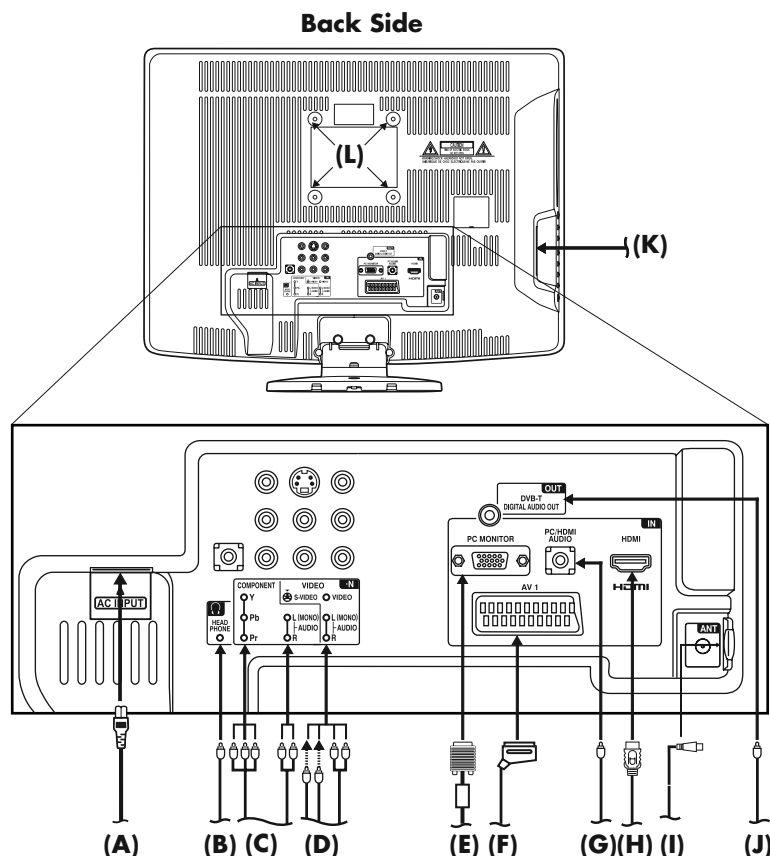

- (A) Power supply:** Connect the supplied AC mains lead to an AC 220~240V/50Hz mains power supply only - do not attempt to connect it to any other type of supply. Never try to repair a damaged AC mains lead with isolation-tape - this should be repaired by a specialist or replaced. Do not let your pet loose near the cable. Animals biting into the cable could receive a fatal electric shock, and could cause a hazard to others.
- (B) HEAD PHONE jack:** Plug headphones with a mini plug (3.5 mm) into this jack.
- (C) COMPONENT inputs:** see page 49.
- (D) AV 2 inputs:** Inputs for analogue A/V-Signal (Composite or S-Video). see page 49.
- (E) PC MONITOR input (PC):** see page 45.
- (F) Scart socket (AV 1):** For the connection of scart cable. See pages 47~49.
- (G) PC/HDMI AUDIO input:** see pages 45, 46.
- (H) HDMI input :** see page 46.
- (I) Aerial input socket:** Connect the outdoor aerial to the aerial input socket as shown.
- (J) Coaxial Digital audio output:** digital output for CD/DVD & DVB-T (see page 48).
- (K) C.I. slot:** for DVB-T-PayTV (still no providers at present) (see page 19).
- (L) Bracket holes:** Fix a wall mounting bracket (not supplied) here.

Auto setup

Your unit has an Automatic installation which makes installation in your unit easy. When you turn on the unit for the first time, the Automatic installation routine is activated. Using this routine, you can select the on-screen language and automatically search for and store all the receivable analogue and digital (DVB) channels.

The Automatic station presetting feature is for the set's built-in tuner only. If you have a device such as a digital decoder (eg. Satellite or Digital Terrestrial) connected (see page 47), you would need to tune it in separately according to its own instructions.



Note:

- To cancel the Auto Tuning, press **EXIT** during the process.
- If on the "Auto installation (Country)" screen "UK" is selected, "Move To" cannot be used in UK (see page 17).

THE AUTOMATIC TUNING PROCESS WILL ONLY START BY ITSELF THE FIRST TIME YOU SWITCH THE SET ON. HOWEVER YOU CAN RESTART THIS PROCESS VIA THE MENU SYSTEM (see page 6 for analogue channels, and page 14 for digital channels).

Preparation:

Press **⏻ (Power)** on the unit or press **⏻ (On/Standby)** on the remote.

1

AUTO INSTALLATION menu will appear. Press **▲** or **▼** to select LANGUAGE, then press **ENTER**. Press **◀** or **▶** to select desired language. Then press **ENTER**.

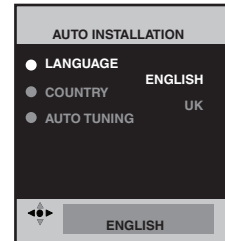

2

Press **▲** or **▼** to select COUNTRY, then press **ENTER**. Press **◀** or **▶** to select your country. Then press **ENTER**.

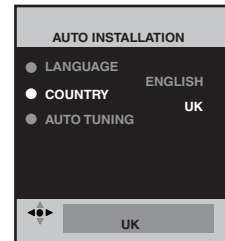

3

Press **▲** or **▼** to select AUTO TUNING, then press **ENTER**. The confirmation screen will be displayed. Press **ENTER** to start automatic tuning. Your TV will now automatically tune in all available channels. Your TV will tune the analogue channels first, then tune the digital channels.

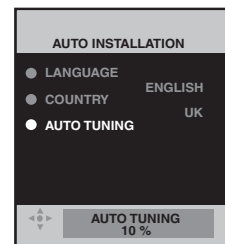

(ANALOGUE)

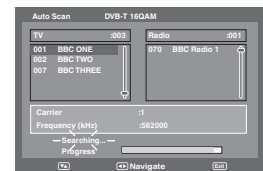

(DIGITAL)

Note:

- Please be patient - the Auto Tuning process can take several minutes to complete.**

When the programme on the screen stops changing and the sound comes on, the search process is complete.

Quick guide for ANALOG MENU operation/Selecting the video input source/On-screen Language Selection

Quick guide for ANALOG MENU operation

Call ANALOG MENU and for example: Select AUTO TUNING.

1

Press **INPUT SELECT**.
Select ATV. Press **ANALOG MENU**.

2

Press ◀ or ▶ to select .

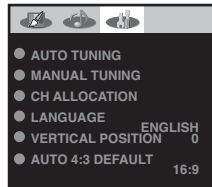

3

Press ▲ or ▼ to select AUTO TUNING, then press **ENTER** to enter the AUTO TUNING menu.

... on the following pages the MENU can be called in the same way as here.

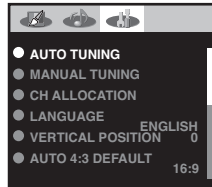

4

Press **EXIT** to return to the normal screen.

Selecting the video input source

Press **INPUT SELECT** to view a signal from another device connected to your TV, such as a VCR. You can select each input source depending on which input jacks you used to connect your devices.

To select the video input source, press ▲/▼. Then press **ENTER** within 6 seconds.

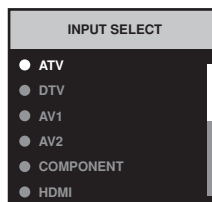

On-screen Language Selection

1

Select LANGUAGE (unless you have already selected when the set was first switched on).

Then press **ENTER**.

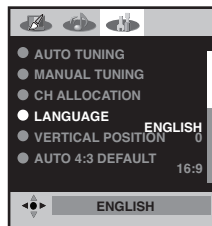

2

Press ◀ or ▶ to select the desired language.

3

Press **EXIT** to return to the normal screen.

Make sure the aerial connection and power supply are connected as per the description on previous page.

Preparations:

- Turn on the unit with the **(Power)** button on the unit. The (On/Timer/Standby) indicator will light up in green.
- To change the unit to standby mode, press (On/Timer/Standby) on the remote control. (On/Timer/Standby) indicator will change from green to red. To turn on the unit from standby mode, press (On/Timer/Standby) on the remote control again.
- In standby mode, you can also turn the unit on with (P) ▲/▼ on the unit or **P + / -** on the remote control.
- To turn off the unit press (Power) button on the unit - to completely switch it off, disconnect the mains power supply.
- Press **TV/DVD** to select the TV mode.
- Press **TV/DVB-T** to select the analogue TV mode.



Note:

- If no buttons are pressed for more than approx. 60 seconds, the MENU disappears automatically.

Automatic station presetting with the built-in Tuner/ Changing the order of stored channels

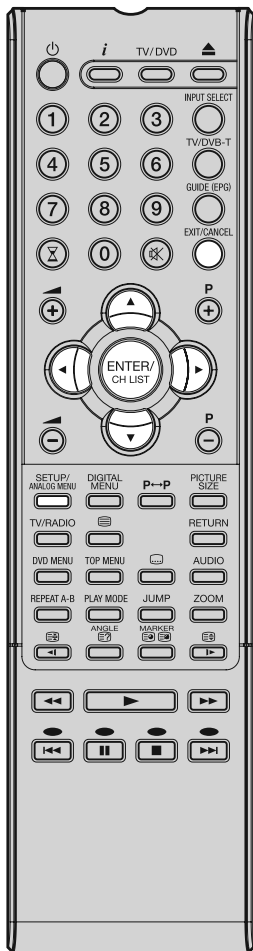

Note:

- To restart digital auto tuning, see page 14.
- When the COUNTRY is set to UK, the automatic tuning will search for UHF broad-casts only.
- When changing the order of the channels, it is best to start with Ch1.

Automatic station presetting with the built-in Tuner

Perform this feature to search for and store new analogue TV programmes after the Automatic installation (see page 4).

Preparation:

Make sure your aerial is connected to the aerial input (see page 3). Select ATV (see page 5). Then press **ANALOG MENU**.

1

Select **AUTO TUNING**, then press **ENTER**.

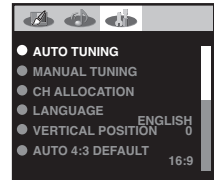

2

Select **COUNTRY**, then press **ENTER**. Press **◀** or **▶** to select your country, then press **ENTER**.



3

Select **START**. Then press **ENTER**. The automatic tuning will search for available broadcasts and should store the channels in the correct order. During the search the sound is muted. When all programs have been stored, the normal TV screen will appear.

Changing the order of stored channels

The Automatic station presetting stores the stations in a specific order. However, this order can be changed if you wish.

1

Select **CH ALLOCATION**. Then press **ENTER**.

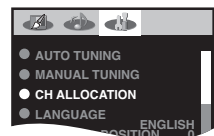

2

Select desired option, then press **ENTER**.

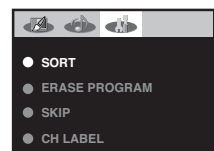

3

After setting the each option, press **ANALOG MENU** to return to **CH ALLOCATION** menu.

4

Press **EXIT** to return to the normal screen.

Description about the each setting option:

SORT: Press **▲** or **▼** to select the channel that you want to move, then press **ENTER**. Press **▲** or **▼** to select the position that you want to move the channel to, then press **ENTER**.

ERASE PROGRAM: Press **▲** or **▼** to select the channel that you want to erase, then press **ENTER**.

SKIP: Press **▲** or **▼** to select the channel that you want to skip, then press **ENTER**. * mark will appear.

CH LABEL: Press **▲** or **▼** to select channel that you want to rename, then press **ENTER**. Press **▲** or **▼** to select character, then press **◀** or **▶**. The cursor will move to the next position. Press **ENTER** to set the channel label.

Manual TV station presetting

If you like, you may manually tune a certain station into a selected program position, without deleting or modifying other program position's contents. Example: Store the BBC 2 into program position 2.

1

Preparation: connect analogue rf-cable-supply. Select program position 2. Press **2** (see page 8). OSD will indicate "2" in right upper corner. Eventually recently stored TV-channel's name might also appear.

2

Press **ANALOG MENU**. Press **◀** or **▶** to select . Press **▲** or **▼** to select **MANUAL TUNING**. Press **ENTER**.

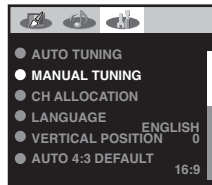

3

Press **▲** or **▼** to select **COLOUR SYSTEM**, then press **ENTER**. Press **◀** or **▶** to select **AUTO**, **PAL** or **SECAM** then press **ENTER**. Please note that **PAL** should be selected for use in UK.

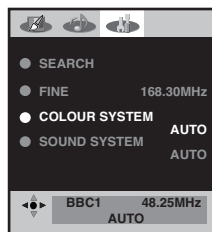

4

Press **▲** or **▼** to select **SOUND SYSTEM**, then press **ENTER**. Press **◀** or **▶** to select **AUTO**, **B/G**, **I**, **D/K** or **L/L'**, then press **ENTER**.

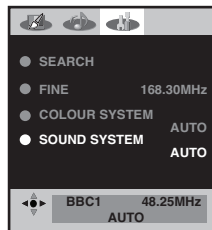

5

Press **▲** or **▼** to select **SEARCH**. Press **ENTER**. Press **◀** or **▶** to start tuning. Tuning will stop automatically at next available station. If this does not happen to be the **BBC 2**, press **◀** or **▶** again to continue tuning for the **BBC 2**. Then press **ENTER**.

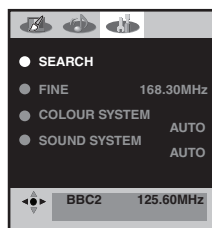

6

If you like use fine-tuning. Select **FINE** and press **ENTER**. Press **▶** or **◀**, to fine tune. See the note on this page.

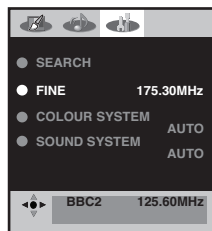

7

To store other stations in additional memory-cells, repeat steps 1 to 6.

8

Press **EXIT** to return to the normal screen.

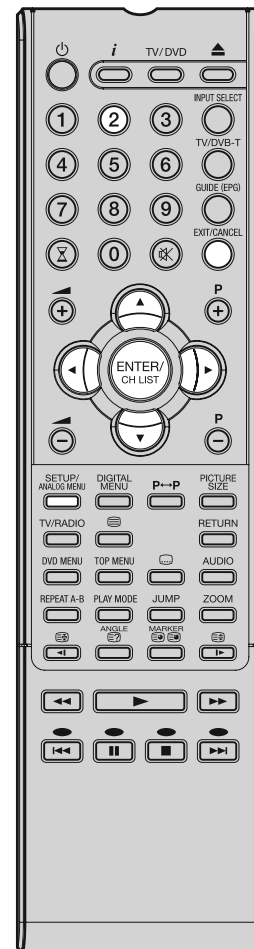

Note:

- Usually fine tuning is not necessary, due to tuning's automatically stopping at the very best position. If you fine-tune anyway, proper working of teletext-reception with built-in tuner is no longer guaranteed.

Basic TV functions

Contents

Connection and Analogue
Channel Setup

Basic TV Features

Digital TV Operation

DVD Operations

Connection to Other
Equipment

Fault-finding guide
and Specifications

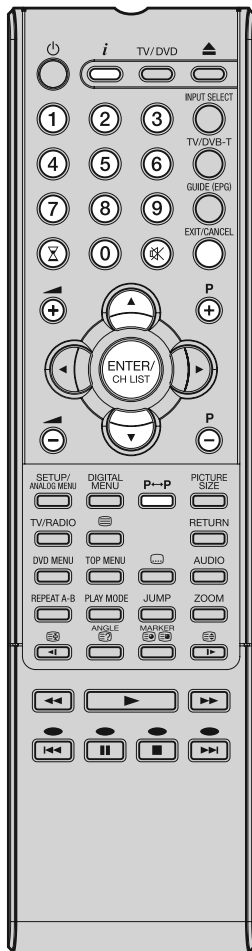

Note:

- If the built-in tuner does not receive anything (e.g. if no aerial is connected) during TV-operation, then the TV-unit will change to standby after approx. 15 minutes.

Channel selection

With the numbered buttons.

Example:

- No. 2: Press **0** and within 2 seconds, press **2**.
 - No. 29: Press **2** and within 2 seconds, press **9**.
- Press **P +** or **-** to change up or down a channel. This takes approx. 2 seconds. If the auto search only stored 5 stations, only these 5 will appear. Skipped channels will not appear (see page 6).

The **CH LIST** shows a list of all receivable programmes. They are located in channels 1 to 99.

Press **CH LIST** to display the CH LIST.

Press **▲** or **▼** to select the desired channel.

Press **CH LIST** to display the selected channel. Press **EXIT** to exit.

QuickView

P↔P button allows you to go back to the last selected channel.

Volume adjusting

Press **▲ +** or **-** to adjust the volume. The volume level indicator disappears after 4 seconds.

MUTE

Press **MUTE**. The sound will be cut off. MUTE will appear for approx. 4 seconds. The muting can be released by pressing **MUTE** again or **▲ +** or **-**.

Information display

In the analogue TV mode: Press **i**. Channel number and picture size setting will appear for approx. 4 seconds.

In the digital TV mode: Press **i**. The program information will appear (see "Channel banner" on page 20).

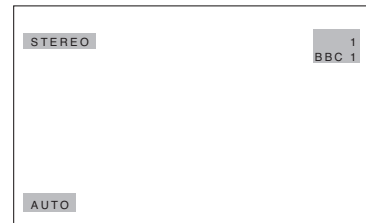

SLEEP TIMER

To set the sleep timer press **SLEEP** and the minutes until shut-off will appear. Each time you press **SLEEP** the SLEEP time shown will change. When the displayed time runs out, the unit will switch to standby. The display will disappear after approx. 4 seconds

To cancel the sleep timer:

Press **SLEEP** repeatedly until "0" appears.



Teletext

Teletext is sent page by page. This unit is able to automatically store up to 256 pages, but they can only be accessed once they have been stored. This can take a few moments.

Fasttext/TOPTtext

The Fasttext/TOPTtext is teletext with a special directory.

On the lower part of the screen there are four different coloured fields (red, green, yellow and blue). These fields lead directly to the pages shown within. The coloured buttons on the remote control correspond to the coloured fields. Press the appropriate coloured button in order to activate the desired colour field.

Switch on/off Teletext

Teletext is not transmitted by all channels.

Select a channel that shows teletext.

Press . You will now see a teletext page. (If "100" is shown without any text information, it may mean that the channel you have selected does not support teletext.)

Press again. The TV-screen will be split into two and both Teletext information and actual broadcast will be displayed at the same time.

Press again in order to switch off teletext.

Press again in order to switch on teletext again. The last page which was stored is now shown.

Note:

- You cannot select any other channels as long as teletext is switched on. Switch teletext off when you want to switch over to another channel.

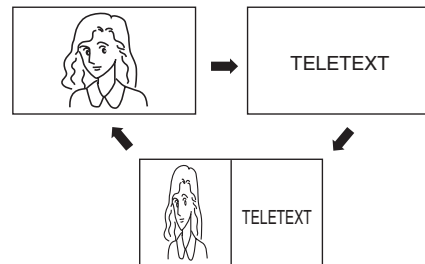

Select Page

Press **P +** or **-** until the page you desire appears. Or ... enter the requested page number by using the **10 Number Buttons**.

And if you mistype something, just enter the complete 3-digit wrong page number then enter the desired number again. Or ... press one of the coloured teletext buttons so that a page from Fasttext/TOPTtext is shown.

Hold Pages

Some pages are divided up into subpages by the channel.

Subpages are automatically shown in turn, as they are transmitted. In order to hold the page, press .

Press again in order to display the next subpage.

Directly Select Subpages

You can directly select the subpages if required.

Example:

Page 128 from Teletext comprises of 2 subpages. In the right upper corner you will, for example, see 1/2. That means that page one of 2 subpages is being shown at the moment.

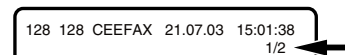

Press in order to select subpage 2. 4 dashes (---) are shown. Enter **0 0 0 2**. It can take a minute before subpage 0002 appears.

Press again in order to switch off the subpage feature.

You can only select other teletext pages when the subpage feature is switched off.

Enlargement

In order to enlarge the display, press .

Either the upper or lower half of the screen is enlarged.

Each time you press you switch between the display of the upper or lower half of the screen or the full picture.

Answering Quiz Questions

Some pages contain quiz questions with concealed answers.

Press in order to show the answers.

Page 100

Press **ENTER** in order to show page 100.



Stereo reception with the built-in analogue tuner

The built-in Tuner can detect and receive NICAM stereo broadcasts automatically.

NICAM stereo sound reception

1

Select **NICAM**, then press **ENTER**.
Press **◀** or **▶** to select **AUTO** or **OFF**.
Select **OFF** if you do not want to receive NICAM sound.

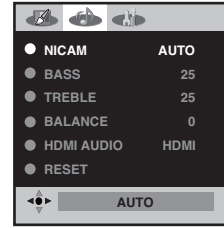

2

Press **EXIT** to return to the normal screen.

The following types of broadcast are possible with NICAM transmissions

"NICAM ST" illuminates for approx. 4 seconds when a NICAM STEREO broadcast signal is received.

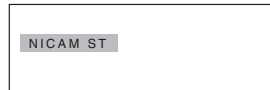

"NICAM M1" illuminates for approx. 4 seconds when a NICAM MONO A broadcast signal is received.

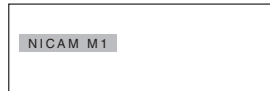

"NICAM M1/M2" illuminates for approx. 4 seconds when a NICAM MONO A and MONO B broadcast signal is received.

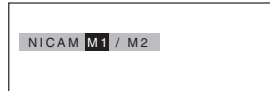

This will be displayed for approx. 4 seconds if a NICAM signal is received when the "NICAM OFF" option is selected.



Stereo reception in Germany

"STEREO" illuminates for approx. 4 seconds when a STEREO broadcast signal is received.



When 2-channel sound reception is available, you can select your preferred audio with the AUDIO button.

Each time you press **AUDIO**, the sound channel will switch to the alternative channel available.

NICAM 2-channel sound reception (not available in Germany)

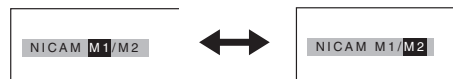

2-channel sound reception in Germany

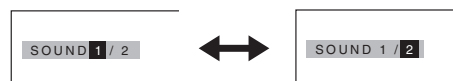

Note:

- In case of bad reception, the stereo sound also can be disturbed.



Picture format

The broadcaster may transmit a Wide Screen Signalling (WSS) signal which can determine the correct picture width and set it automatically when the AUTO setting is used. If you want to change this setting, you can select from the formats listed below.

AUTO

Press **PICTURE SIZE** repeatedly until AUTO appears.

Manual format setting

Pressing **PICTURE SIZE** repeatedly scrolls through the following options.

4:3

This mode shows a 4:3 picture in its original size and shape with vertical bands on the left and right side.

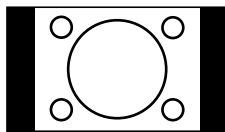

FULL SCREEN

Stretches the left and right hand sides of a 4:3 picture horizontally to fill the screen, while leaving the centre of the picture unstretched.

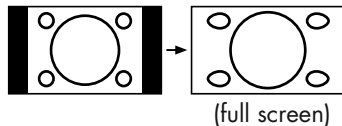

Note:

- In this mode the picture is geometrically distorted on the left and the right sides of the screen.

16:9

This mode is used with 16:9 signals from a Digital decoder, DVD player or other external source. This uniformly stretches a 4:3 image horizontally to fill the screen (For example, a 16:9 image is often stored "anamorphically" on a DVD, where the 16:9 image is stored as a horizontally compressed 4:3 image - this mode restores the image to its correct 16:9 proportions).

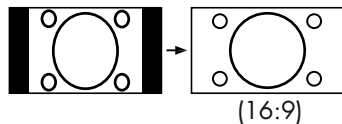

CINEMA

This mode is used to zoom-in on (expand) 4:3 "letterbox" format pictures (with black bars at the top and bottom) so that they fill more of the screen.

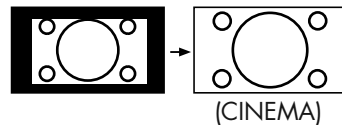

Note:

- In the CINEMA mode, part of the picture may be slightly cut off due to the expansion. However, it is possible to scroll the picture up or down to view the top or bottom part of the picture ("VERTICAL POSITION", see page 12).

14:9

This enlarges a 4:3 picture to the 14:9 format.

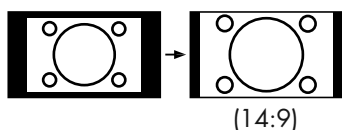



Note:

- The picture size cannot be adjusted in PC operation.
- For 720p and 1080i signals the **PICTURE SIZE** button does not work.
- External receivers can automatically adjust the picture size via a SCART cable. Please read the instructions for the external receiver.



Other convenience functions

You can change the default settings to convenience use.

Icon	Selected Items		Setup hint
	PICTURE PREFERENCE	SPORTS	Bright and dynamic picture (factory-set)
		STANDARD	Standard picture quality (factory-set)
		MOVIE	Movie-like picture setting (factory-set)
		MEMORY	Your personal preferences
	BRIGHTNESS / CONTRAST / COLOUR / TINT(NTSC) / SHARPNESS		You can adjust the picture to your preference. The "TINT(NTSC)" option can be selected if an NTSC 3.58MHz or NTSC 4.43MHz signal is input through one of the AV sockets, and NTSC or AUTO has been selected for the AV COLOUR option.
	COLOUR TEMPERATURE		Bluish (COOL) / Neutral (MEDIUM) / Reddish (WARM)
	BLUE BACK	ON / OFF	You can set the TV to automatically change to a blue screen and mute the sound if the signal is weak or absent.
	BACKLIGHT		You can use the Back light feature to adjust the screen brightness for improved picture clarity.
RESET		Select "RESET" to reset PICTURE PREFERENCE, BRIGHTNESS, CONTRAST, COLOUR, TINT(NTSC), SHARPNESS, COLOUR TEMPERATURE and BACKLIGHT to the factory preset values.	
	NICAM		See page 10.
	BASS / TREBLE / BALANCE		You can adjust the sound quality to your preference.
	HDMI AUDIO		See page 46.
	RESET		Select "RESET" to reset BASS, TREBLE and BALANCE to the factory preset values.
	AUTO TUNING		See page 6.
	MANUAL TUNING		See page 7.
	CH ALLOCATION		See page 6.
	LANGUAGE		See page 5.
	VERTICAL POSITION		When the CINEMA mode is selected (see page 11), you can adjust the vertical picture position. Press ◀ or ▶ to adjust the vertical position of the picture by up to +10 and downwards by up to -10.
	AUTO 4:3 DEFAULT *	4:3 / 16:9	This option selects the default way that a 4:3 signal is shown - either as normal "4:3" or expanded in the "16:9" mode, according to your preferences.
	AV1 OUTPUT		See page 50.
	AV COLOUR		See page 50.
	REC SCREEN STATUS	ON / OFF	This function is used in conjunction with the Timer function that is included as part of the Digital EPG. It determines whether the TV screen switches on or not when a programmed Timer setting begins - see page 23 for further details.
	RESET TV SETTING		Press ENTER to enter the RESET TV SETTING screen. Press ▲ or ▼ to select "YES", then press ENTER . Reset the TV function will now begin, and this unit will automatically turn off.

Note:

- * AUTO 4:3 DEFAULT is available only for AUTO picture size setting.
- * In COMPONENT mode, AUTO 4:3 DEFAULT is available only for 480i/576i mode.

Guide to using the Digital Menu System

Preparation:

Press **TV/DVB-T** to select the digital TV mode.

1

Press **DIGITAL MENU** to display the Main menu. Press **◀** or **▶** to select desired options. (Example: selecting the Language Setup option.)

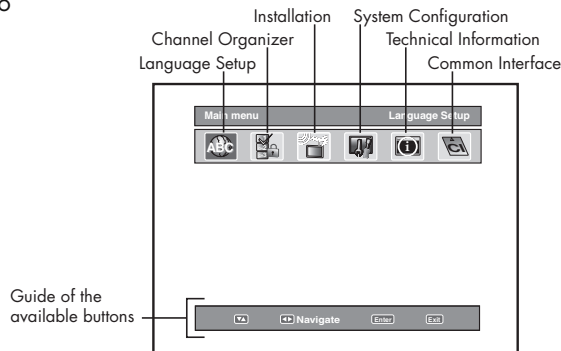

2

Press **ENTER**. The selected menu will appear.

Some of the options have a sub menu. Press **▲** or **▼** to select desired sub menu, then press **ENTER**.

(Example: sub menu in the Installation option.)

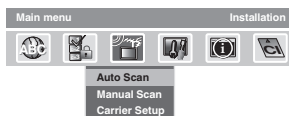
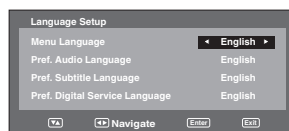

3

When you have finished making adjustments, press **EXIT** to return to the normal screen.

Note:

- In analogue TV mode, **DIGITAL MENU** will not work. Please press **TV/DVB-T** to select digital TV mode to display the digital menu. However, it is possible to use the **ANALOG MENU** in the digital TV mode. The analogue menu includes some general settings for this TV that apply to both modes, and it will be displayed over the digital TV screen.

When the set is in the digital mode, you can access the main menu by pressing **DIGITAL MENU** on the remote control. This main menu contains several options,

- Language Setup
- Channel Organizer
- Installation
- System Configuration
- Technical Information
- Common Interface

The main menu is the gateway for all the other "sub" menus. You can navigate between the different options in the main menu by pressing **◀** or **▶**.

The **DIGITAL MENU** key will also function like an **EXIT** key, i.e. when any menu is active, pressing the **DIGITAL MENU** key will return to the previous stage.

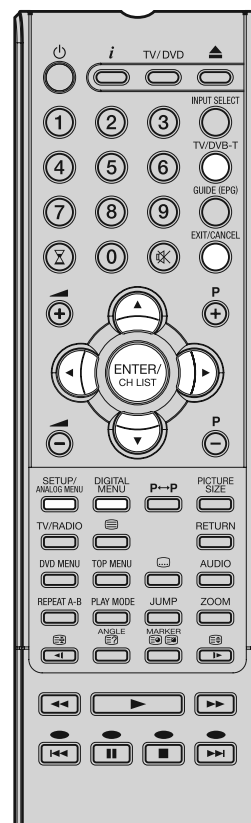

Contents

Connection and Analogue Channel Setup

Basic TV Features

Digital TV Operation

DVD Operations

Connection to Other Equipment

Fault-finding guide and Specifications

Language Setup/Auto Scan

Contents

Connection and Analogue Channel Setup

Basic TV Features

Digital TV Operation

DVD Operations

Connection to Other Equipment

Four: finding guide and Specifications

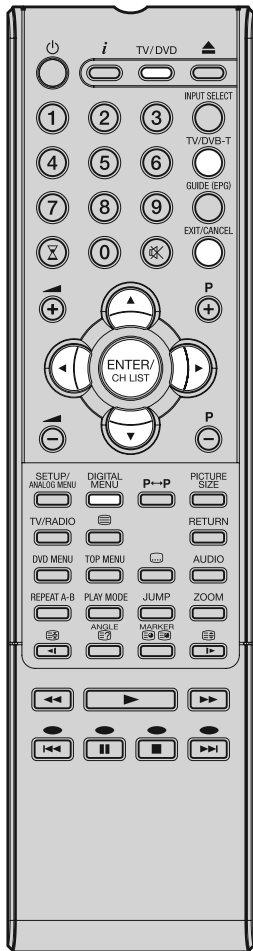

Language Setup

Preparation:

Switch on appliance. Press **TV/DVD** to select the TV mode, then press **TV/DVB-T**.

The appliance switches over to DVB-T-mode.

Menu languages supported are English, French, German, Italian, Spanish, Russian, Portuguese, Dutch, Polish, Swedish, Turkish, Finnish and Greek. (Welsh and Gaelic are available only for Digital Service Language.)

1

Press **DIGITAL MENU**, the menu will appear on the screen.



Press **◀** or **▶** to select Language Setup option, then press **ENTER**.

2

Language Setup menu will appear. Press **▲** or **▼** to select the item you want to change.

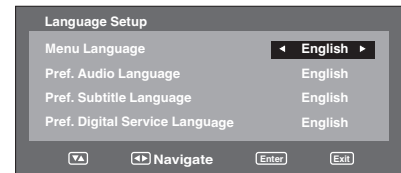

Press **◀** or **▶** to select desired language.

3

When all changes are decided, press **EXIT** to return to the normal screen.

Auto Scan

Preparation:

Please ensure that all the connections have been made correctly (see page 3).

1

Press **▲** or **▼** to select "Auto Scan" then press **ENTER**.

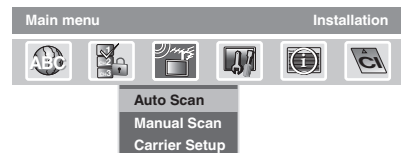

2

The confirmation banner will be displayed.

Press **◀** or **▶** to select "Yes" or "No", then press **ENTER**.

3

The Auto Scan process will now begin. The scanning process will be displayed in the progress bar.

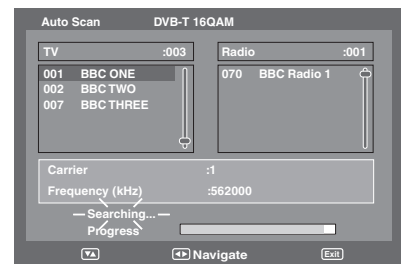

Note:

- If "FINLAND" is selected on the "AUTO INSTALLATION (COUNTRY)" screen, two languages are displayed for each item and the first selected language has priority. The language output depends on the languages contained in the broadcast.
- All the channels will be deleted before the scanning process begins.
- You can cancel the scan process at any time by pressing **EXIT**. The carriers and the services stored before **EXIT** is pressed will be stored.

Manual Scan/Carrier Setup

Manual Scan

With the Manual Scan option, you can tune one carrier at a time, by entering the carrier parameters manually.

1

Press **▲** or **▼** to select "Manual Scan", then press **ENTER**.

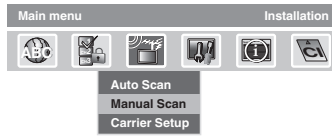

2

You can choose the carrier number from the Channel list by using **◀** or **▶** and the corresponding frequency set for the carrier will be set for tuning.

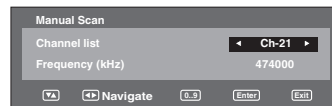

Otherwise you can also directly enter the frequency value to start the tuning.

3

After setting the carrier, press **ENTER** to start the scanning. During the scan process, the list of services (TV/Radio) collected for the carrier will be listed.

4

Then the confirmation banner will be displayed. Press **◀** or **▶** to select "Yes" or "No", then press **ENTER**.

5

Press **EXIT** to return to the normal screen.

Carrier Setup

The Carrier setup option menu lists all the carriers (multiplexes) that are currently available and allows you to Rename, Delete or Rescan carriers individually.

1

Press **▲** or **▼** to select "Carrier Setup" then press **ENTER**.

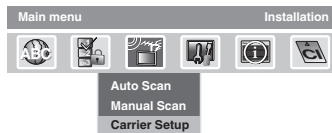

2

All the carriers are listed with their frequency and service information - the user can scroll through the carrier list and select each one individually to Rename, Delete or Rescan.

3

Rename:

Select carrier, then press **Red** button. The alphanumeric keypad will appear. You can rename a service as per your preference (see page 16).

Delete:

Select carrier, then press **Green** button. The check mark (✓) will be displayed for selected carrier. Then press **ENTER**. The confirmation banner will be displayed.

Press **◀** or **▶** to select "Yes" or "No", then press **ENTER**. If the option "Yes" is selected then all the marked carriers will be deleted from the list.

Rescan:

Rescan allows to tune the already tuned carrier, to collect any new programmes that are currently available in the stream. Press **Blue** button, to rescan the current selected carrier.

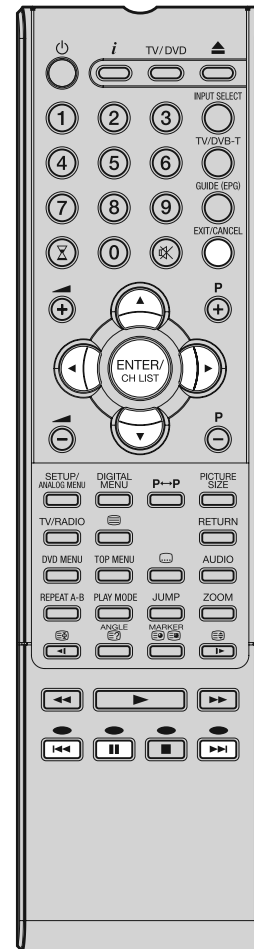

Note:

- If on the "Auto Installation (country)" screen "Finland" is selected, "Frequency (kHz)" cannot be used.
- When the Country is set to Finland in the "Auto installation (Country)" If there is a Channel List in the data after Auto Scan or Manual Scan, Channel Type Selection Menu will be displayed and available to set Channel List Type. Select the Channel List Type by pressing **◀/▶** and press **ENTER**
- If "FINLAND" is selected on the "Auto Installation (country)" screen, Data is displayed on the "Carrier Setup" screen.

Channel Organizer

The Channel Organizer feature provides options to organise the channels. The following options are supported: Favourite, Lock, Skip, Go To, Delete, Rename, Move, Move To, View.

1

Press ◀ or ▶ to select Channel Organizer option, then press **ENTER**.

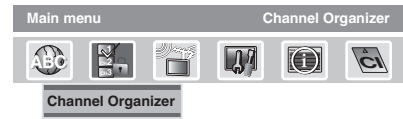

2

The Channel Organizer menu will appear. The available programmes will be listed, depending on the current mode. The selected programme will be highlighted. To toggle within the service list, press ▲ or ▼.



3

By pressing the corresponding **Number Button (1-8)** or the **ENTER** key, you can activate the following functions from this menu for each channel: Favourite, Lock, Skip, Go To, Delete, Rename, Move, Move To and View. (You can deactivate each of these functions by pressing the same number again.) See page 16 for setting details.

Indications:

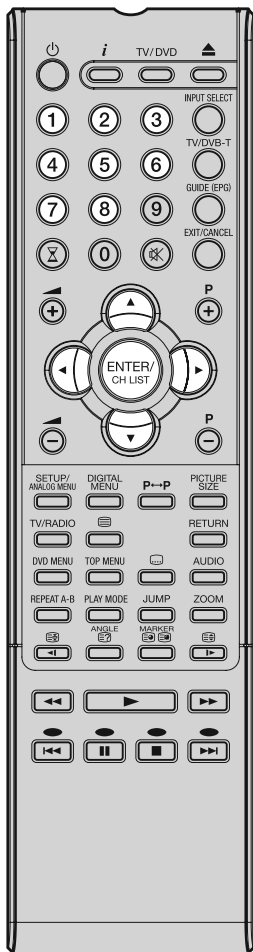
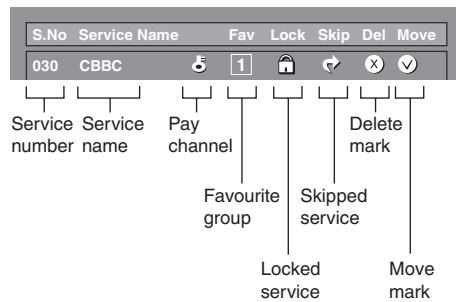

Note:

- While in TV mode, only TV programmes will be displayed and only radio programmes will be displayed while in radio mode.
- The displays of Channel / Service name will be abbreviated depend on its size of the letter.

Channel Organizer

Setting details

Fav *1	None	Assign services to four different favourite groups. ① Press ▲/▼ to select the desired service.
	Fav1	② Press 1 on the remote control. A selection box displays.
	Fav2	③ Press ▲/▼ to register the selected service to any of the four favourite groups (None, Fav1 ... Fav4) and then press ENTER . An icon displays indicating the favourite status.
	Fav3	④ Press DIGITAL MENU .
	Fav4	⑤ Now you can easily select your favourite service from the Channel List (See page 20).
Lock		When the service is locked, you must enter your PIN whenever you tune to the service. ① Press ▲/▼ to select the desired service. ② Press 2 on the remote control. If you already set the PIN, enter it here. If not, enter the factory preset PIN "0000". An icon displays indicating the service is locked. • Pressing 2 will turn the lock icon on and off. (PIN entry is required.) ③ Press DIGITAL MENU .
Skip		Services that are set to skip will not be picked up when pressing P +/- . ① Press ▲/▼ to select the desired service. ② Press 3 on the remote control. An icon displays indicating the service to be skipped. • Pressing 3 will turn the skip icon on and off. ③ Press DIGITAL MENU . • To view services that are set to be skipped, use 0-9 or select from the Channel List.
Go To		Use this function to jump to the specific service in one step. This is useful when there are many services displayed on screen to scroll through. ① Press 4 on the remote control. Now you can change the service number on the left side of the screen. ② Enter the number using 0-9 , and then press ENTER . The highlight moves to the selected service.
Delete		Delete the selected service(s) from the memory. ① Press ▲/▼ to select the desired service. ② Press 5 on the remote control. An icon displays indicating the service to be deleted. • Pressing 5 will turn the delete icon on and off. ③ Press DIGITAL MENU . A confirmation message displays. ④ Press ◀/▶ to select "Yes", and then press ENTER .
Rename		Change individual service names. ① Press ▲/▼ to select the desired service. ② Press 6 on the remote control. A character set screen displays. ③ Enter new name for the service. ④ Press DIGITAL MENU . A confirmation message displays. ⑤ Press ◀/▶ to select "Yes", and then press ENTER .
Move		Sort the order of the selected service by moving the service position. ① Press ▲/▼ to select the desired service. ② Press 7 on the remote control. An icon displays indicating the service to be moved. • Pressing 7 will turn the move icon on and off. ③ Move the selected service to the desired position using ▲/▼, and then press ENTER to register the change.
Move To *2		Sort the order of the selected service by modifying the service number. ① Press ▲/▼ to select the desired service. ② Press 8 on the remote control. Now you can change the service number on the left side of the screen. ③ Enter the number using 0-9 , and then press ENTER . The service moves to the new position.
View		Change to the service shown in the picture window. ① Press ▲/▼ to select the desired service. ② Press ENTER on the remote control. The image shown in the picture window changes. ③ Press EXIT to exit the Channel Organizer screen to view the image in full screen

Note:

*1 You cannot register the same service to two different favourite groups.

*2 If on the "AUTO INSTALLATION (COUNTRY)" screen "UK" is selected, "Move To" cannot be used in U.K.

Display Setup/Password Setup (Parental lock)

Contents

Connection and Analogue Channel Setup

Basic TV Features

Digital TV Operation

DVD Operations

Connection to Other Equipment

Fault-finding guide and Specifications

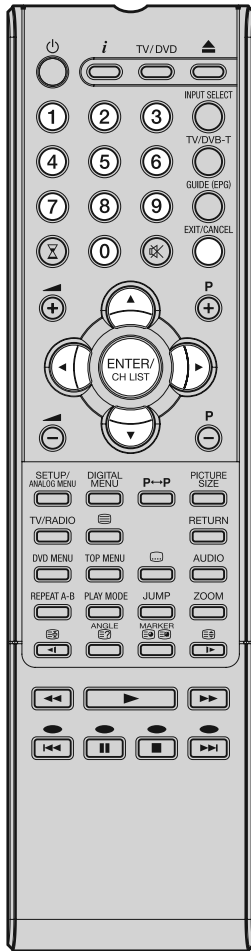

Display Setup

1

Press **▲** or **▼** to select "Display Setup", then press **ENTER**.

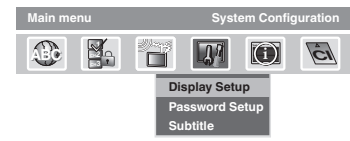

2

Display Setup menu will appear. Press **▲** or **▼** to select the item you want to change. Then you can change each setting by pressing **◀** or **▶**.

Banner timeout	1 Sec, 2 Sec. ... 7 Sec.	Select how long the service banner information appears on screen.
Banner position	Top Bottom	Select whether the service banner information appears on top or bottom of the screen.
Display Transparency	None 10%, 20% ... 50%	Select the desired level of On-Screen Display transparency.

3

After all the changes are made, press **EXIT** to return to the normal screen.

Password Setup (Parental lock)

This feature allows you to have a parental control of the service viewing as per your preference. Once a service is protected with a password, it cannot be viewed unless the correct password is provided.

1

Press **▲** or **▼** to select "Password Setup", then press **ENTER**.

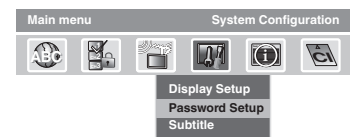

2

"Enter Password" will appear. Press "0 0 0 0" using the **Number Buttons**. (This is the default password.)

3

Press **▲** or **▼** to select "Parental Lock", then press **◀** or **▶** to select desired parental rating (see note). Then press **EXIT** to return to the normal screen.

4

You can also change the password using the next option. Press **▲** or **▼** to select "Change password".

Then enter your chosen new password (be sure to remember this password). After you have entered the new password for the first time, you need to enter the same password again for confirmation. The Information banner will then appear.

Press **EXIT** to return to the normal screen.

While toggling between channels, if a service which has a parental rating is selected then you will be asked to enter the correct password to view that channel. If the channel you are currently watching supports a parental rating then the rating will also be displayed in the Channel banner menu (see page 20).

Note:

- There are 15 age-based ratings, ranging from "4" (years old) to "18" (years old) and "None". Eg. If the Parental Lock is set to "8" (years old), only the services which have the parental rating of "8" (years old) or under will be viewable without entering the Password.
- You will be prompted to enter the password, when you set new parental rating.
- You can set the new parental rating only when you enter the password correctly, otherwise the old parental code will be retained.

Version/Software Upgrade/Common Interface

Version

You can check the software and hardware versions.

1

Press **▲** or **▼** to select "Version", then press **ENTER**.
The hardware and software versions are displayed.



Software Upgrade

Software Upgrade allows you to download the latest software available on the Engineering channel.

1

Press **▲** or **▼** to select "Software upgrade", then press **ENTER**.

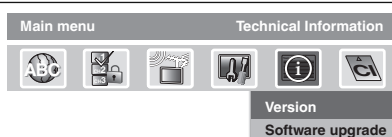

2

If a software upgrade is available from an Over-Air-Download (OAD) then the message "S/W available, do you want to download?" will be displayed - you can then select "Yes" or "No" by pressing **◀** or **▶**, then press **ENTER**.

3

If you select the option "Yes" then the Software Upgrade process will be initiated. It will take about 20 minutes and after this process is complete, the TV will be rebooted automatically.

If you select the option "No" you can continue to watch TV programmes as before.

Common Interface

You can access the Common Interface module information from this menu option.

Preparation:

Insert CAM into the DVB Common Interface slot on the backside of the TV (see page 3).

1

Press **◀** or **▶** to select "Common Interface" option, then press **ENTER**.



2

The CAM module name will be displayed. You have to press **ENTER** to view further information.

3

In the CI Menu, CAM specific information such as Module information, Smart card information, Language and Software Download are shown. Press **▲** or **▼** to select information, then press **ENTER** to see detail.

4

Press **EXIT** to return to the normal screen.

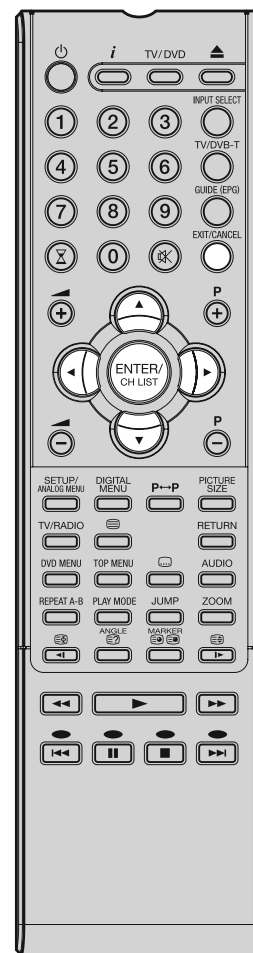

Note:

- During the Software Updating process, do not turn off the unit. At this time you cannot use any of the buttons, apart from **⏻ (Power)**.
- After the Software Updating process, the Digital Menu memory settings will be lost, so it is necessary to go through the setting up procedures again.

Contents

Connection and Analogue
Channel Setup

Basic TV Features

Digital TV Operation

DVD Operations

Connection to Other
Equipment

Fault-finding guide
and Specifications

Channel list/Channel banner

Contents

Connection and Analogue Channel Setup

Basic TV Features

Digital TV Operation

DVD Operations

Connection to Other Equipment

Fault-finding guide and Specifications

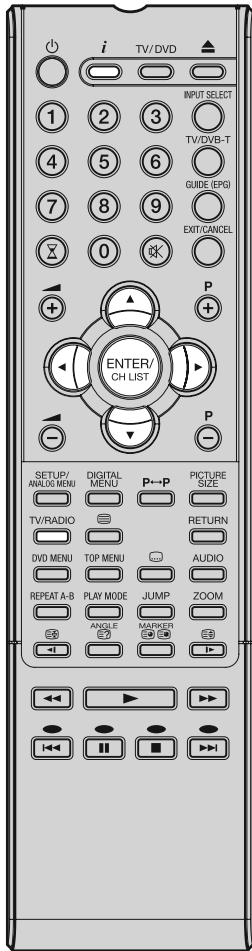

Channel list

1

Press **CH LIST** to display the Channel list menu.

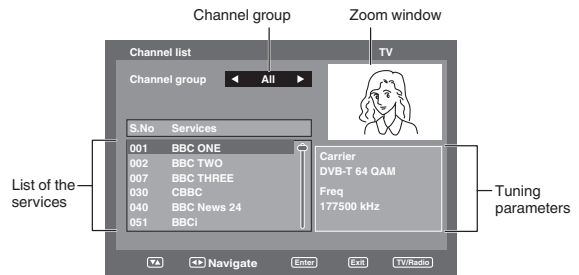

2

Select the Channel group (Favourite):

Press **◀** or **▶** to select between Channel groups - you can toggle through All (complete channel list)/Fav1/Fav2/Fav3/Fav4 (see "Favourite" on page 17 for details on setting Favourites).

Select the Services:

List of the services present under the selected Channel group will be displayed in the left side of the menu.

Press **▲** or **▼** to toggle within the service list, then press **ENTER**.

Toggle between the list of TV and Radio services:

The **TV/RADIO** key is used to toggle between the TV and Radio mode. If you press **CH LIST** when you are in Radio mode then the channel list menu will display the list of Radio services. If you wish to view the list of TV services without exiting the current menu, **TV/RADIO** key should be pressed once.

Channel banner

When you change from one channel to another, the Channel banner will be displayed for the selected service. In the channel banner menu, information such as current date & time, channel name, etc. will be displayed.

1

While watching the service, press **i** to display the Channel banner at any time. It will disappear after the Banner timeout value (this can be adjusted to your preferred value, see page 18).

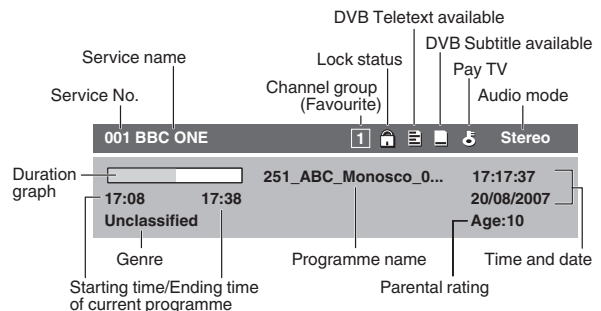

2

Press **i** again to display the Basic Service Information. You can verify the signal strength and quality of the selected service here.

- If necessary, adjust the direction of the aerial to obtain the maximum signal strength.
- When the Country setting has been set to FINLAND, press **i** once more to display the advanced detailed information.

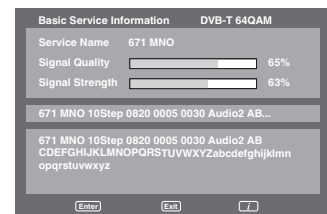

3

To remove the Channel banner immediately, press **i** again.

Note:

- If any Channel group doesn't have any service at the time, "No services" and "No Information" will be displayed in the menu.
- Channel / Service names can only be displayed up to about 10 characters - if the name is longer than this, it will be abbreviated.
- Subtitles are displayed on the channel banner. Some broadcasts may not provide this service.

Multi audio/DVB-Subtitle

Multi audio

You can select your preferred Audio mode and DVB (digital TV) subtitle Language.
The Multi audio menu will display the Audio mode and Language options available with the current broadcast.

1

Press **AUDIO** to display the Multi audio menu.
The Audio mode and Language code will be displayed if available.



2

To select Audio mode, press ◀ or ▶.
In general the below audio modes will be supported in a service.
Stereo, Left, Right and L + R.

To select a language code, press ▲ or ▼ to select code within language code list.

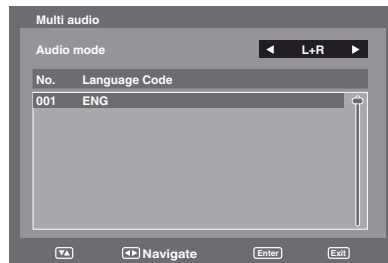

3

Press **EXIT**. Your selected audio preferences will be saved.

DVB-Subtitle

DVB-Subtitle is a feature supported in DVB (Digital Video Broadcasting) applications in which the service shown can be accompanied by a text display on the screen in parallel with the corresponding audio service. The DVB-Subtitle feature can be enabled or disabled at anytime.

1

Press ▲ or ▼ to select "Subtitle", then press **ENTER**.

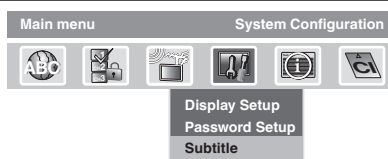

2

Press ◀ or ▶ to select your desired subtitle language from the available languages.

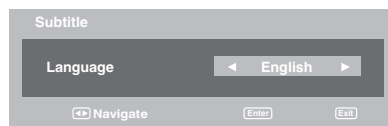

3

To turn off the DVB-Subtitle, press ◀ or ▶ repeatedly until "Off" appears in the Subtitle menu.
Press **EXIT**. Your selected subtitle language will be saved.

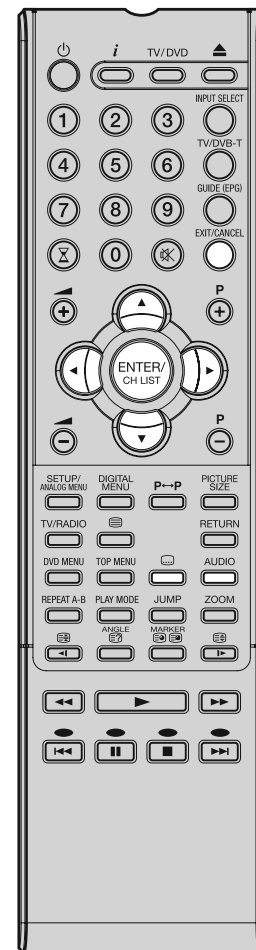

Note:

- DVB-Subtitle can also be changed by pressing of [INFO] repeatedly.

Contents

Connection and Analogue Channel Setup

Basic TV Features

Digital TV Operation

DVD Operations

Connection to Other Equipment

Fault-finding guide and Specifications

EPG (Electronic Program Guide)

The Guide menu shows the available programme listings for the next 8 days only, including today. However, the guide menu will show "No Event Name" for programmes which are more than 8 days ahead, or for programmes within the 8 days when no programme information is available.

1 Press **GUIDE(EPG)** to display the Guide menu.



Service list:

Lists all the services that are currently available. As you scroll through the service list by pressing **▲** or **▼**, the Event list will be refreshed accordingly, and you will see the programme information for the currently highlighted programme. To scroll through the service list page by page, press **Red** or **Green** Key.

Events list:

List the events in a grid of rows and columns. Each row shows the list of events that are available, for the corresponding service in the service list. Within each row, you can press **◀** or **▶** to navigate through the rest of the events. You can easily move to the Previous day or Next day in the Events List by pressing **Yellow** or **Blue** key (the date of the programme information you are currently viewing is shown in the top right hand corner).

The full Event name along with the duration of the event will be displayed in the bar above. Event title will be displayed only if available otherwise "No Description" message will be displayed.

2

From within the Guide menu, you can open the Description menu for the currently highlighted programme by pressing **i**.

The Guide/Description menu shows the extended event description of an event. You can scroll and view the complete event description of the event using **▲** or **▼**.

To return to the Guide menu, press **i**.
To clear the menu screen, press **EXIT**.

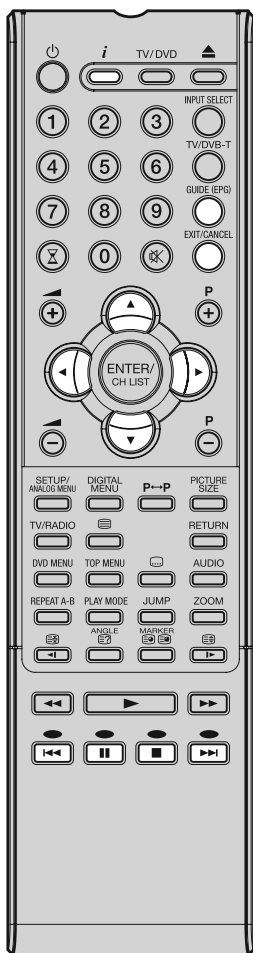

Contents

Connection and Analogue Channel Setup

Basic TV Features

Digital TV Operation

DVD Operations

Connection to Other Equipment

Four: finding guide and Specifications

EPG Timer

You can choose whether or not the screen switches on when the timer event begins - please see page 12 (Rec screen status (LCD Power on/off)). This is so that if you are using the timer to make a recording to your VCR or other device, the TV screen will not switch on unless you want it to. If you try to switch to another channel while a timer event is in progress, the following message will appear: "WARNING: CHANGING THE CHANNEL WILL INTERRUPT YOUR EVENT TIMER. ARE YOU SURE YOU WANT TO PROCEED? YES/NO". Select Yes or No according to your wishes.

1

Press **GUIDE(EPG)** to display the Guide menu. Then press **▲/▼/◀/▶** to highlight the programme you want to set as a timer event, then press **ENTER**.

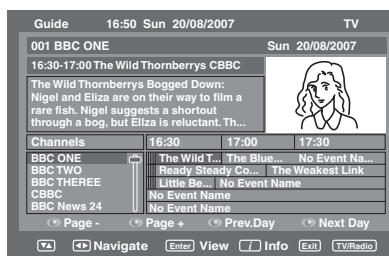

Note:

- If you select an event which has already started, the selected program will be displayed on the screen, as you cannot set the timer for a programme which has already started.
- To display the stored timer events, press **GUIDE(EPG)** twice. The EPG Timer menu (see step 3 below) will appear. You can also delete or change the frequency (Once / Daily / Weekly) of the stored timer events (but please note that you cannot edit the time details that have been set from the EPG).

2

The confirmation banner will be displayed. Press **◀** or **▶** to select "Yes" or "No", then press **ENTER** (the selected option is shown in blue).

3

The EPG Timer menu will appear. Press the **Red** key to set the Timer mode for a selected event.

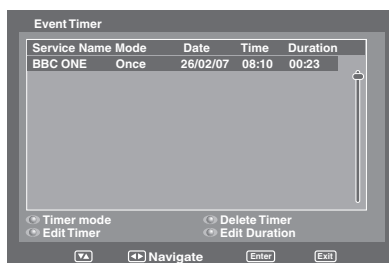

4

The Timer mode specifies the frequency of Timer wake-up which can be set as Once, Daily or Weekly. Press **ENTER** to save the selected Timer mode.

Note:

- To delete a timer event, select the specified event, then press the **Green** key.

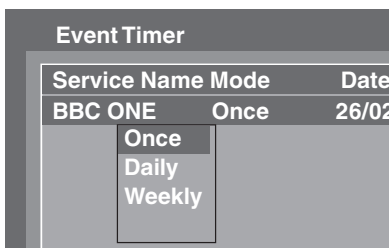

5

To return to the Guide menu, press **DIGITAL MENU**. To clear the menu screen, press **EXIT**.

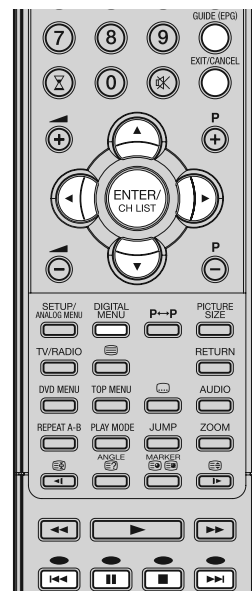

Note:

- A maximum of eight Timers can be programmed.
- If the EPG Timer starts when it is already switched on, it will start at the exact time that is set. If it starts from the standby mode, it will begin 20 seconds in advance of the stated time.
- You cannot hasten the start time from the original start time of the Event.
- You cannot set with the same date and time of another Event.
- Press the **Yellow** key to change the start time of the event.
- Press the **Blue** key to change the time duration of the event.
- If the EPG Timer begins during standby mode, the **On/timer/Standby** indicator on the unit will be lit in orange. This is to indicate that an EPG Timer event has begun in standby mode.

Disc

DVD discs must be Region 2 or Region ALL type to play on this unit. The loaded Disc (DVD and Audio-CD) will be recognized automatically. The suitable disc formats are: DVD-Video, DVD-R/-RW (Video format only), Audio CD, CD-R/CD-RW, Video CD and SVCD.

Some CD-R/RW discs may be incompatible.

- This unit can play an 8cm disc. Please do not use a disc adapter. It may cause trouble.
- Please do not insert any disc of an irregular shape into the unit, as it may interfere with the function of the unit.
- You may not be able to remove it.
- Please do not use after market accessories, such as a ring protector, as this may cause trouble with the operation of the unit.

Do not play DVD-ROM, DVD-Audio, CD-G or Photo CD to prevent accidental erasure of prerecorded material.

Title

When two or more movies are recorded on a disc, the disc is divided into two or more sections. Each section is called a "TITLE".

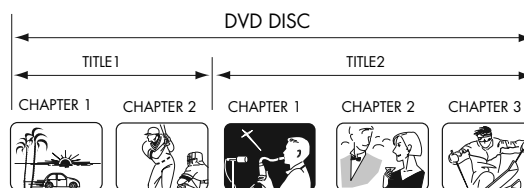

Chapter

The titles can be subdivided into many sections. Each section is called a "CHAPTER".

Track

An Audio CD can contain several items. These are assigned to tracks.

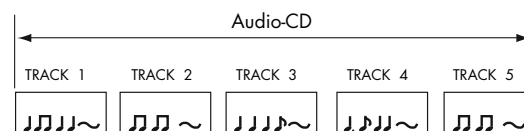

Removing Disc from Case

Be sure to hold the edge of disc. Do not touch the surface of the disc.

- Do not scratch the disc.
- Do not get dirt on the surface of the disc.
- Do not stick a label or adhesive tape on the disc.
- Do not drop or bend the disc.

Storing Disc

- Store the disc in the case to avoid risk of scratches, dirt or damage.
- Do not leave disc exposed to direct sunlight or in hot or humid places.

Cleaning Disc

Wipe the disc with a clean, dry cloth from center to edge.

- Do not wipe in circular direction.
- Do not use liquid or aerosol cleaners.

On Video CDs

This unit supports Video CDs equipped with the PBC (Version 2.0) function. (PBC is the abbreviation of Playback Control.) You can enjoy two playback variations depending on types of discs.

- Video CD not equipped with PBC function (Version 1.1) Sound and movie can be played on this DVD/VCR in the same way as an audio CD.
- Video CD equipped with PBC function (Version 2.0) In addition to operation of a Video CD not equipped with the PBC function, you can enjoy playback of interactive software with search function by using the menu displayed on the TV screen (Menu Playback). Some of the functions described in this owner's manual may not work with some discs.

To turn off the PBC

1. Press **PLAY MODE** in the Stop mode.
2. Press **▲/▼** to select "Mode", then press **ENTER** repeatedly until "off" appears.
3. Press **PLAY MODE** again to clear the screen.

To turn on the PBC

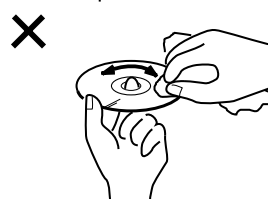
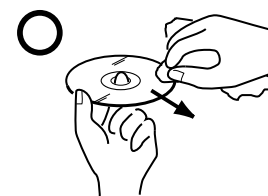

Follow the above step 1~2, then press **ENTER** repeatedly until "PBC" appear.



Playing a disc

This section shows you the basics on how to play a disc.

Basic playback (DVD/VCD/Audio CD) Preparation

Make sure that the  (**Power**) switch on the unit is pushed in (ON). (The  (On/Timer/Standby) indicator lights up.)

1

Press **TV/DVD** on the remote control to select the DVD mode.



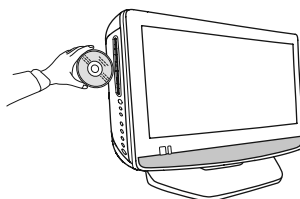

2

Place the disc in the disc slot with the label side facing forward. (If the disc has a label.)



- Do not place a disc which is unplayable in this unit.



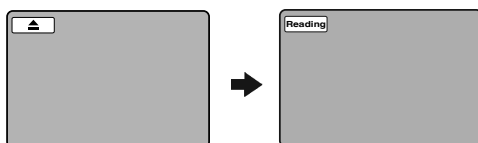

3

- On the TV-screen, "" changes to "Reading" and then playback commences.
- A menu screen will appear on the TV screen if the disc has a menu feature.
- Press /// to select title, then press **ENTER**. Title is selected and play commences.



4

Press  (**STOP**) to end playback.

- The unit records the stopped point, depending on the disc. "" appears on the screen. Press  (**PLAY**) to resume playback (from the scene point).
- If you press  (**STOP**) again ("" appears on the screen.), the unit will clear the stopped point.

To start playback in the stop mode

Press  (**PLAY**).

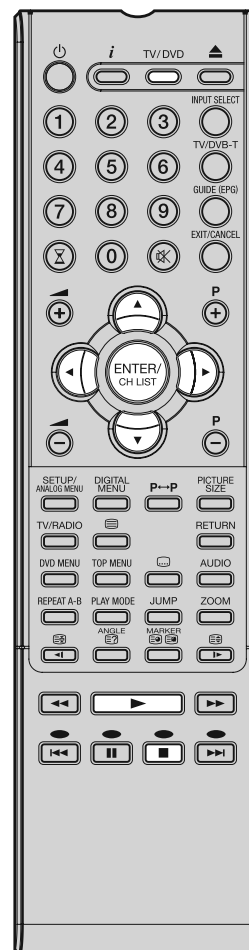

Note:

- **If the unit does not operate properly:** Static electricity, etc., may affect the player's operation. Disconnect the AC mains lead once, then connect it again.
- If a disc is inserted during some modes other than DVD mode, it may switch to DVD mode and then playback may be begun automatically.

Playing a disc

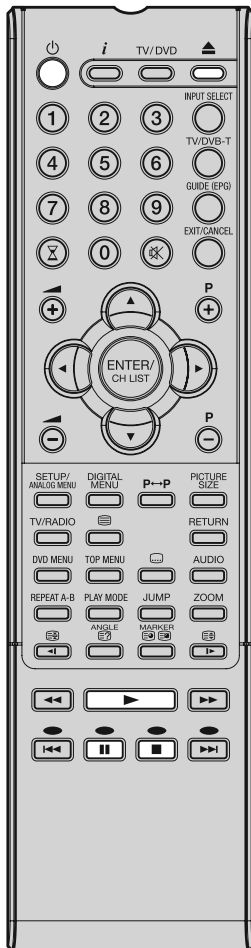

To pause playback (still mode)

Press **II (PAUSE)** during playback.
To resume normal playback, press **▶ (PLAY)**.

- The sound is muted during still mode.

To stop playback

Press **■ (STOP)**.

To remove the disc

Press **▲ (EJECT)**.

Remove the disc after the disc comes out.

Note:

- If a non-compatible disc is loaded, "Incorrect Disc", "Region Code Error" or "Parental Error" will appear on the TV screen according to the type of loaded disc. In this case, check your disc again (see pages 24 and 42).
- Some discs may take a minute or so to start playback.
- When you set a single-faced disc label backwards (i.e. the wrong way), "Reading" will appear on the display for a few minutes and then "Incorrect Disc" will continue to be displayed.
- Some discs may not work the resuming facility.
- Resuming cannot function when you play a PBC-featured Video CD while the PBC is on. To turn off the PBC, see page 24.
- Some playback operations of DVDs may be intentionally fixed by software producers. Since this unit plays DVDs according to the disc contents the software producers designed, some playback features may not be available. Also refer to the instructions supplied with the DVDs.
- Do not move the unit during playback. Doing so may damage the disc.
- In many instances, a menu screen will appear after playback of a movie is completed. Prolonged display of an on-screen menu may damage your television set, permanently etching that image onto its screen. To avoid this, be sure to press **⏻ (Power)** on your remote control once the movie is completed.
- There may be a slight delay between the button is pressed and the function activates.

Playing a disc

You can play discs at various speeds.

Playing in fast reverse or fast forward directions (DVD/VCD/ Audio CD)

Press ◀◀ or ▶▶ during playback.

◀◀: Fast reverse playback

▶▶: Fast forward playback

Each time you press ◀◀ or ▶▶, the playback speed changes.

To stop playback

Press ■ (STOP).

Note:

- The unit mutes sound during reverse and forward scan of DVD/VCD/Audio CD discs.
- The playback speed may differ depending on the disc.

Playing frame by frame (DVD/VCD)

Press ⏸ (PAUSE) during still playback.

Each time you press ⏸ (PAUSE), the picture advances one frame.

To resume normal playback

Press ▶ (PLAY).

Note:

- The sound is muted during frame by frame playback.

Playing in slow-motion (DVD/VCD)

Press ◀| or |▶ during playback.

Each time you press ◀| or |▶, the slow-motion speed changes.

To resume normal playback

Press ▶ (PLAY).

Note:

- The sound is muted during slow-motion playback.
- Reverse slow (◀|) does not work on VCD.

Locating a chapter or track (DVD/VCD/Audio CD)

Press ⏮ or ⏭ repeatedly to display the chapter or track number you want.

Press ⏭ to playback starts from the selected chapter or track.

Press ⏮ to locate succeeding chapters or tracks.

Playback starts from the beginning of the current chapter or track.

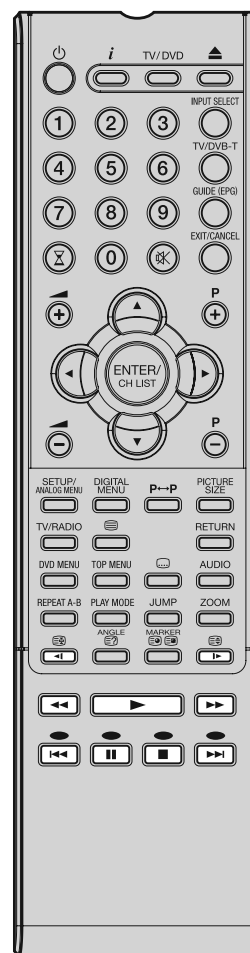

Note:

- A prohibition symbol "X" may appear at the upper right of the screen. This symbol means either the feature you tried is not available on the disc, or the unit cannot access the feature at this time. This does not indicate a problem with the unit.

Zooming/Locating desired scene

Zooming (DVD/VCD)

This unit will allow you to zoom in on the frame image. You can then make selections by switching the position of the frame.

1

Press **ZOOM** during playback.



The centre part of the image will be zoomed in. Each press of **ZOOM** will change the ZOOM Q1(x 1.3), Q2 (x 1.5) and Q3 (x 2.0).

2

Press **▲/▼/◀/▶** to view a different part of the frame. You may move the frame from the centre position to UP, DOWN, LEFT or RIGHT direction.

3

In the zoom mode, press **ZOOM** repeatedly to return to a 1:1 view (Q Off).

Note:

- You can select the Pause or Slow in the zoom mode.
- Some discs may not respond to zoom feature.

Locating desired scene (DVD/VCD/Audio CD)

Use the title, chapter and time recorded on the DVD disc to locate the desired point to playback. In the case of VCD/Audio CD discs, time and track are used to locate the desired point to playback. To check the title, chapter/track and time, press **i**.

1

Press **JUMP** during playback or resume stop mode.

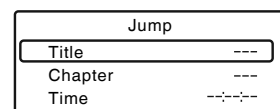

2

Press **▲** or **▼** to select the "Title/Track", "Chapter" or "Time".

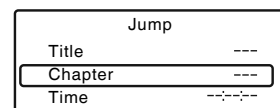

3

Press **Number buttons (0-9)** to input the number.

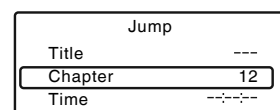

- If you input a wrong number, press **CANCEL**.
- Refer to the package supplied with the disc to check the numbers.

4

Press **ENTER**. Playback starts.

- When you change the title, playback starts from Chapter 1 of the selected title.
- Some discs may not work in the above operation.

Note:

- In case of the Audio CD and Video-CD, only Track and Time can be selected.
- In case of the Video-CD playback with PBC, the JUMP does not work. Turn off the PBC (see page 24).

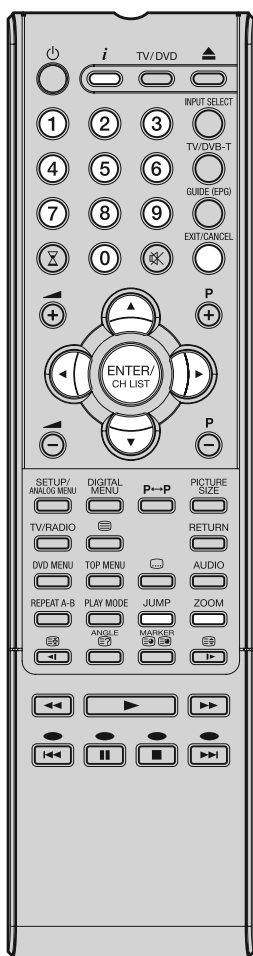

Marking desired scenes

Marking the scenes (DVD/VCD/Audio CD)

The unit stores the points that you want to watch again up to 3 points. You can resume playback from each scene.

1

Press **MARKER** during playback.

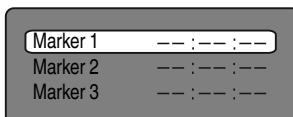

2

Select the blank Marker using **▲** or **▼**. Then press **ENTER** at the desired scene.

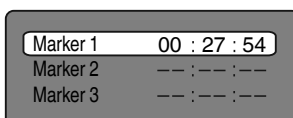

- Repeat this procedure to set the other 2 scenes.

3

Press **MARKER** to clear this display.

Returning to the scenes (DVD/VCD/Audio CD)

1

Press **MARKER** during playback or stop mode.

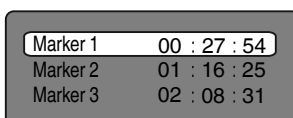

2

Press **▲** or **▼** to select the Marker 1-3.

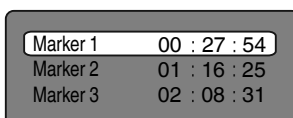

3

Press **ENTER**.

Playback starts from the marked scene.

To cancel the Marker

Follow the above steps 1~2, then press **CANCEL**.

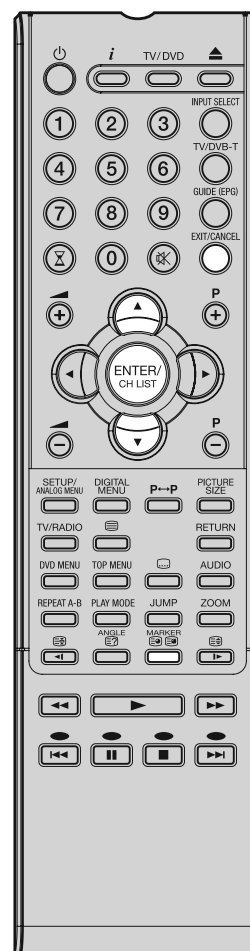

Note:

- Some discs may not work with the marking operation.
- The marking is cancelled when you eject the disc or turn the power off.
- Some subtitles recorded around the marker may fail to appear.
- In case of Video CD with PBC, Marker function is prohibited.
- Marker function does not work with MP3/JPEG CD.

Contents

Connection and Analogue Channel Setup

Basic TV Features

Digital TV Operation

DVD Operations

Connection to Other Equipment

Fault-finding guide and Specifications

Repeat playback/A-B Repeat playback

Repeat playback (DVD/VCD)

1

Press **PLAY MODE** during playback or stop mode.

2

Press **ENTER** repeatedly to select "Chapter" or "Title".

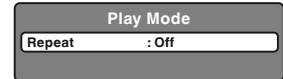

The unit automatically starts repeat playback after finishing the current title or chapter.

[Video CD]

Press **▼** to select "Repeat".

Press **ENTER** to select "Track" or "All".

- If you set the repeat mode during stop mode, press **▶ (PLAY)** to start Repeat playback.

3

Press **PLAY MODE** again to clear the screen.

To resume normal playback

Select Repeat : "Off" in step 2.

Note:

- Some discs may not work with the repeat operation.
- In case of Video CD with PBC, Repeat functions are prohibited during playback.
- Chapter/Track repeat function is cancelled whenever **◀◀ (SKIP)** or **▶▶ (SKIP)** is pressed.

A-B Repeat playback (DVD/VCD/Audio CD)

A-B repeat playback allows you to repeat selection between two selected points.

1

Press **REPEAT A-B** during playback.
The start point is selected.

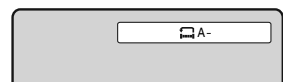

2

Press **REPEAT A-B** again.



The end point is selected. Playback starts at the point that you selected. Playback stops at the end point and returns to Point A automatically, then starts again.

To resume normal playback

Press **REPEAT A-B** again.

"Off" appears on the screen.

Note:

- In A-B Repeat mode, subtitles near the A or B locations may not be displayed.
- You may not be able to set A-B Repeat for the scenes that include multiple angles.
- A-B Repeat playback does not work when Repeat playback is activated.
- You may not be able to set A-B Repeat during certain scenes of the DVD.

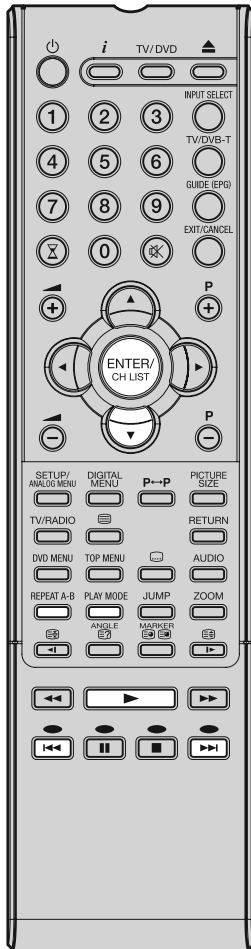

Changing angles/Title selection/DVD menu

Changing angles (DVD)

When playing back a disc recorded with multi-angle facility, you can change the angle that you are viewing the scene from.

1

Press **ANGLE** during playback.
The current angle will appear.



2

Press **ANGLE** repeatedly until the desired angle is selected.

Note:

- Depending on the DVD, you may not be able to change the angles even if multi-angles are recorded on the DVD.

Title selection (DVD)

Two or more titles are recorded on some discs. If the title menu is recorded on the disc, you can select the desired title.

1

Press **TOP MENU** during playback.
Title menu appears on the screen.

2

Press **▲/▼/◀/▶** to select the desired title.

3

Press **ENTER** or **▶ (PLAY)**.
The playback of the selected title will start.

Note:

- Some DVDs allow you to select the disc contents using the menu.
When you playback these DVDs, you can select the subtitle language and soundtrack language, etc. using the menu.

DVD menu (DVD)

Two or more titles are recorded on some discs. If the title menu is recorded on the disc, you can select the desired title.

1

Press **DVD MENU** during playback.
The DVD menu appears on the screen.

- Press **DVD MENU** again to resume playback at the scene when you pressed **DVD MENU**.

2

Press **▲/▼/◀/▶** to select the desired item.

3

Press **ENTER**.
The menu continues to another screen. Repeat steps 2 and 3 to set the item completely.

Note:

- Depending on the DVD, you may not be able to resume playback from the scene point when you press **DVD MENU**.

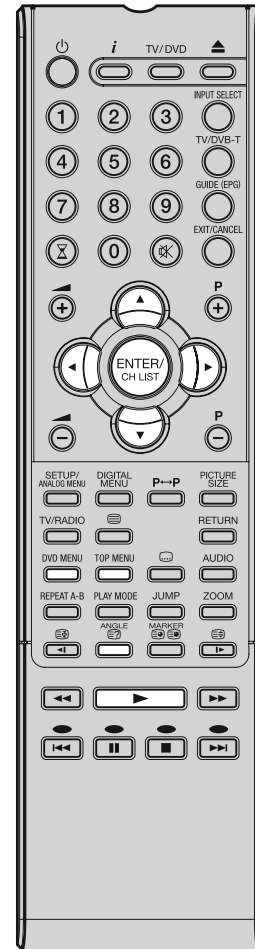

Contents

Connection and Analogue
Channel Setup

Basic TV Features

Digital TV Operation

DVD Operations

Connection to Other
Equipment

Fault-finding guide
and Specifications

Changing soundtrack language/Subtitles/Disc status

Contents

Connection and Analogue Channel Setup

Basic TV Features

Digital TV Operation

DVD Operations

Connection to Other Equipment

Fault-finding guide and Specifications



Changing Soundtrack Language (DVD/VCD)

You can select the language when you play a multilingual disc.

1

Press **AUDIO** during playback.
The current soundtrack language will appear.

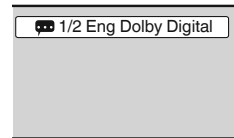

2

Press **AUDIO** repeatedly until the desired language is selected.
• The on screen display will disappear after a few seconds.

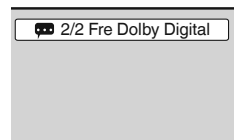

In case of Video CD playback

Audio type changes as follows each time you press **AUDIO**.



Subtitles (DVD)

When playing back a disc recorded with subtitles, you can select the subtitle language or turn the subtitle off.

1

Press **SUBTITLE** repeatedly during playback until the desired language is selected.

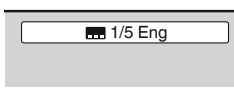

2

To turn off the subtitle, press **SUBTITLE** until "Off" appears.
The on screen display will disappear after a few seconds.

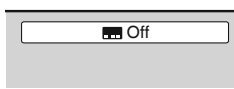

Disc status

With press of **i**, the status of the disc will appear on the screen.
To cancel the display, press **i** again.

[Video CD]

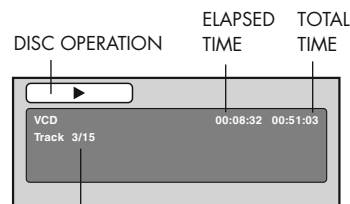

TRACK NO.

[DVD]

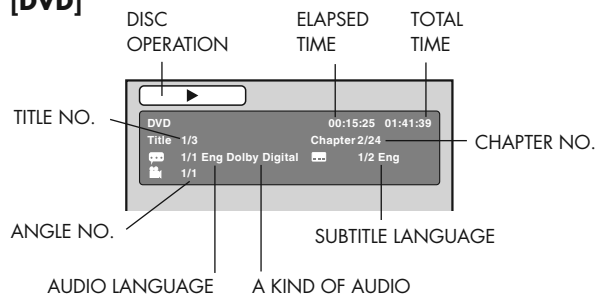

TITLE NO.

CHAPTER NO.

ANGLE NO.

SUBTITLE LANGUAGE

AUDIO LANGUAGE

A KIND OF AUDIO

Note:

- If the desired language is not heard after pressing the button several times, the language is not recorded on the disc.
- The selected soundtrack language is cancelled when you eject the disc. The initial default language or available language will be heard if the disc is played back again.
- If you select DTS in playing DTS-encoded disc, no sound will be heard.
- Depending on the DVD, you may not be able to change subtitles, or to turn subtitles on or off.
- While playing a DVD, the subtitle may change when you loaded or eject the disc.
- In some cases, a selected subtitle language may not be changed immediately.

MP3/WMA/JPEG and Audio CD operation

This unit can playback the MP3/WMA/JPEG-data which has been recorded on CD-R/RW. Audio CD also can be played back. To produce the MP3/WMA JPEG-data, you need a Windows-PC with CD-RW drive and a MP3/WMA/JPEG-encoding Software (not supplied). The Apple-HFS-System cannot be played. This unit requires discs/recordings to meet certain technical standards in order to achieve optimal playback quality.

There are many different types of recordable disc formats (including CD-R containing MP3/WMA files). Not all recordable discs will produce optimal playback quality. The technical criteria set forth in this instruction manual are meant only as a guide. Use of CD-RW for MP3 files is not recommended.

MP3/WMA/JPEG - data information

Limitations on MP3/WMA/JPEG playback

- MP3/WMA/JPEG CD are standardized by ISO9660, its file name must include following extensions; ".mp3", ".wma", ".jpg".
- MP3/WMA/JPEG CD must be corresponded to the ISO standardized files.
- This unit can read 2000 files per disc. If one disc has more than 2000 files, it reads up to 2000 files, the remaining files will be omitted.
- MP3/WMA/JPEG CDs cannot be used for the purpose of recording on this unit.
- If the CD has both CDA audio tracks and MP3/WMA/JPEG files, only the CDA audio tracks will be played.
- It may take more than one minute for this unit to read MP3/WMA/JPEG files depending on its structure.
- Music recorded by "Joliet Recording Specification" can be played back.
- The music files recorded by "Hierarchical File System" (HFS) cannot be played.

Limitations on displaying of the file name.

- The maximum number for display is 15 characters. Long file names will be condensed.
- Available characters for display are the following:
capital or small alphabets of A through Z, numbers of 0 through 9, and _ (under score).
- Other characters than those above are replaced in hyphen.

To playback MP3/WMA/JPEG CD in the recorded order.

1. Use MP3/WMA/JPEG software that records data alphabetically or numerically.
2. Insert two or three digit number in the head of file name. (ex. "01" "02" or "001" "002").
3. Refrain from making too many sub-folders.

CAUTION:

- Some MP3/WMA/JPEG CDs cannot be played back depending on the recording conditions.
- The CD-R/RW that has no music data or non MP3/WMA/JPEG files cannot be played back.

Standard sampling frequency and the bit rate:

MP3

MPEG-1 Audio

32kHz, 44.1kHz, 48kHz

32kbps ~ 320kbps (constant bit rate or variable bit rate)

The recommend recording setting for a high-quality sound is 44.1kHz of sampling frequency and 128kbps of constant bit rate.

WMA

WMA version 7 and 8

32kHz/48kbps, 44.1kHz/48kbps~192kbps, 48kHz/128kbps~192kbps

The file recorded by mono, 48kHz, 48 kbps is not available to this unit.

MP3/WMA/JPEG and Audio CD operation

Loading CD

1

Load a MP3/WMA/JPEG CD or an Audio CD into the disc slot.

2

A file browser screen will appear on the screen. In case the current directory includes 9 files or more, press ▲ or ▼ to scroll in the file list.

To see contents in folder, select the folder and then press **ENTER**. To return to the parent directory, select "Go Up ..." then press **ENTER**.

In case of a CD containing a mixture of MP3, WMA and files, the files are played back by selecting them from the file browser.

Operation status File number Elapsed time Selected file name

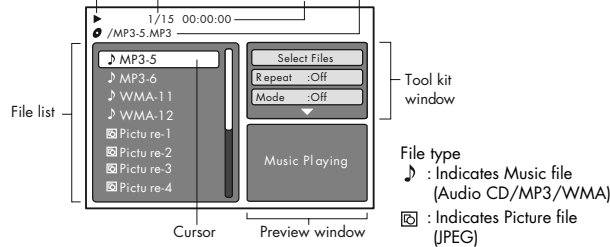

MP3/WMA and Audio CD playback

1

In the file browser, press ▲/▼ to select the desired file.

When ▶ (**PLAY**) is pressed after displaying file browser displayed, playback begins automatically starting from the first file. In this case, if the first file is an MP3/WMA file, only MP3/WMA files are played back in order. If the first file is a JPEG file, the first JPEG file is played back. If there is no file at a root directory, playback does not begin automatically.

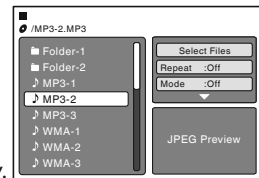

2

Press **ENTER**.
The selected file starts playing back.

3

Press ■ (**STOP**) to end playback.
The selected file starts playing back.

- The unit records the stopped point. "■" appears on the screen. Press ▶ (**PLAY**) to resume playback (from the scene point).
- If you press ■ (**STOP**) again or unload the disc, the unit will clear the stopped point.

Select Files

The file type to make it display in the file browser can be chosen.

1. Press ◀ or ▶ to select "Select Files" at right column in the file browser.
- Press **ENTER**, then press ▲ or ▼ to select file type from the list (Music or Picture).
1. Press **ENTER** to add/remove check mark. Checked file type will be displayed in the file browser.
2. Press **RETURN** to save the setting.

Note:

- MP3 or WMA file on the Kodak Picture CD is not recognized on this unit.
- During MP3/WMA/JPEG-Playback, you cannot use JUMP and A-B Repeat functions.
- You can use Repeat (Track or All), Random functions and Program playback for MP3/WMA/JPEG-Playback (See pages 36, 37)

MP3/WMA/JPEG and Audio CD operation

JPEG playback

1

In the file browser, press ▲/▼ to select the desired JPEG file.
To display a thumbnail list, press **DVD MENU**.
Press ▲/▼/◀/▶ to select the desired file.
(To return to the file browser, press **TOP MENU**.)
When ► (**PLAY**) is pressed after displaying the file browser, playback begins automatically starting from the first file. In this case, if the first file is a JPEG file, the first JPEG file is played back.

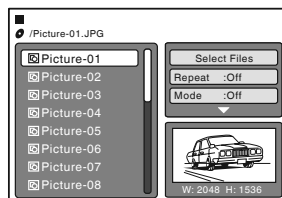

If the first file is an MP3/WMA file, only MP3/WMA files are played back in order. If there is no file at a root directory, playback does not begin automatically.

2

Press **ENTER**. The selected picture appears on the screen.

Rotating an image

You can rotate an image by 90 degrees.
Press **ANGLE** during playback of the image.
"↺", "↻", "↻", "↺" or "↻" appears on the screen.

Zooming an image

Zoom function also can be used in viewing JPEG files.
Press **ZOOM** (See "Zooming" on page 28).

3

Press ■ to end playback.
The file browser appears on the screen. If you want to watch the other file, repeat steps 1~2.

Slide show playback

The slide show enables you to view pictures (files) one after another automatically.

Preparation:

Set "JPEG Interval" setting to "Off", "5 Seconds", "10 Seconds" or "15 Seconds" (See page 41).

1

Select your desired starting file for the slide show in step 1 above.

2

Press **ENTER** or ► (**PLAY**) to start slide show from the selected file.
If you press ■ (**PAUSE**) during the slide show, the slide show stops temporary.
"⏸" appears briefly on the screen.
If the picture appears upside down or sideways, press **ANGLE** repeatedly until it's right side up. "↺", "↻", "↻", "↺" or "↻" appears on the screen.
Press ► (**PLAY**) or ►► (**SKIP**) again to resume the slide show.
When the slide show playback finished, the file list appears.
To stop the slide show, press ■ (**STOP**). The file list appears.

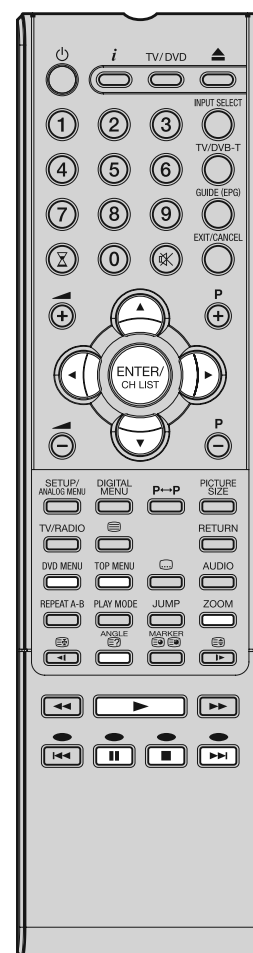

Note:

- During JPEG playback, you cannot use Jump and A-B Repeat functions.
- When an image exceeds 5760 x 3840 pixels, the entire image (preview window or thumbnail list) may not be displayed on a screen.
- It may have a longer interval due to the size of data.

MP3/WMA/JPEG and Audio CD operation

Contents

Connection and Analogue Channel Setup

Basic TV Features

Digital TV Operation

DVD Operations

Connection to Other Equipment

Four-finding guide and Specifications

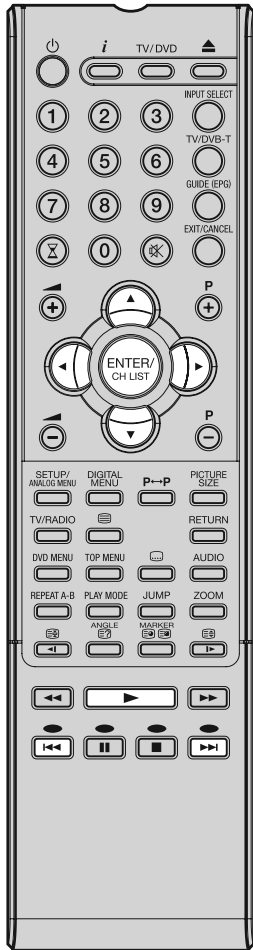

Repeat playback (Audio CD/MP3/WMA/JPEG)

1

In the file browser, press ▲/▼/◀/▶ to select "Repeat" during stop mode.



2

Press **ENTER** repeatedly to select "Track" or "All".



3

Press **▶ (PLAY)**.

The unit automatically starts repeat playback after finishing the current track.

To resume normal playback

Select Repeat : "Off" in step 2.

Random playback (Audio CD/MP3/WMA/JPEG)

1

In the file browser, press ▲/▼/◀/▶ to select "Mode" during stop mode.

2

Press **ENTER** to select "Random".



3

Press **▶ (PLAY)**.

The Random playback will start.

To resume normal playback

Select Mode : "Off" in step 2.



Note:

- The repeat or random function is cancelled when you eject the disc or turn the power off.
- The track repeat function is cancelled when **◀◀** or **▶▶** is pressed.
- In case of Audio CD, the function of A-B Repeat also can be used. See "A-B Repeat playback" (See page 30).

MP3/WMA/JPEG and Audio CD operation

Program playback (Audio CD/MP3/WMA/JPEG)

1

In the file browser, press ▲/▼/◀/▶ to select "Edit Mode", then press **ENTER**.



When "Edit Mode" is black colour, you can mark the files which you want to add into Program list.

2

Press ▲/▼/◀/▶ to select the file you want to add into the program list.



Press **ENTER**. Selected file was marked. Repeat this procedure to select the other files.

3

Press ▲/▼/◀/▶ to select "Add To Program". Then press **ENTER**. All marked files are added into the program list.



When you finish storing the files you want into the Program list, select "Edit Mode" again and press **ENTER** to release edit mode.

4

Press ▲/▼ to select "Program View", then press **ENTER**. Program View shows only the programmed files that you have added in Step 2.

Browser View



Program View



5

In the Program View, press ► (**PLAY**). The files start to playback in programmed order that were added by you.

To remove file from program list in stop mode

In the Edit Mode, switch to Program View. Select the files you want to remove, then press **ENTER**. Select "Clear Program" and press **ENTER**. Marked file is removed from program list.

Note:

- The program function is cancelled when you eject the disc or turn the power off.

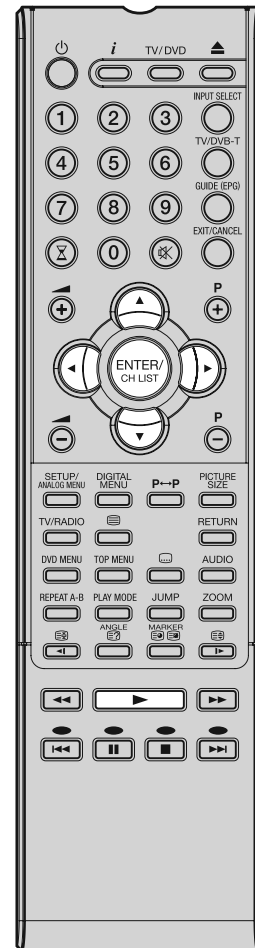

Program playback/Random playback

Contents

Connection and Analogue Channel Setup

Basic TV Features

Digital TV Operation

DVD Operations

Connection to Other Equipment

Fast finding guide and Specifications

You can arrange the playback order of tracks or files on the disc. And the unit can also select tracks or files at random and playback them. This feature works for Video CD.

For Audio CD and MP3/WMA/JPEG CD, please see "Random playback (Audio CD/MP3/WMA/JPEG)" on page 36 and "Program playback (Audio CD/MP3/WMA/JPEG)" on page 37.

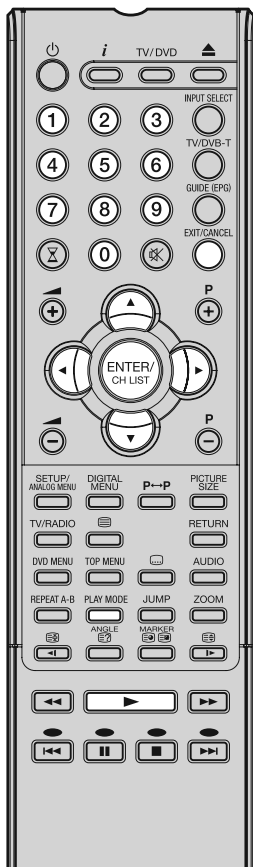

Program playback (VCD)

1

Press **PLAY MODE** during stop mode.

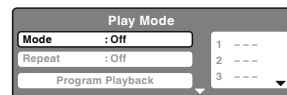

2

Press **◀/▶** to select "Mode", then press **ENTER** to select "Program".

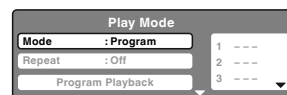

3

Press **◀/▶** to select the programming position. Use **Number buttons (0-9)** to input the track numbers on sequentially.

- If you input a wrong number, press **CANCEL**.

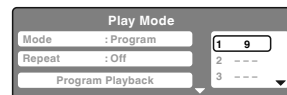

4

Press **◀/▶** to return to the left column, then press **▲/▼** to select the "Program Playback" and press **ENTER**.

The programs you selected will start to playback in order.

- To resume normal playback, select Mode "Off" in step 2.

To change the program

1. Select Mode to "Program" (as step 2), press **▲/▼/◀/▶** to select the track number you want to change, then press **CANCEL**.
2. Press **Number buttons (0-9)** to overwrite the new track number.

To clear the program one by one

Select Mode to "Program", press **▲/▼/◀/▶** to select the track number. Then press **CANCEL**.

To clear all the programs

In the above column, press **▲/▼** to select "Clear Program". Then press **ENTER**.

Random playback (VCD)

1

Press **PLAY MODE** during playback or stop mode.

2

Press **▲/▼** to select "Mode", then press **ENTER** to select "Random".

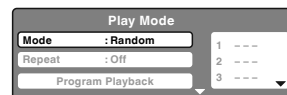

3

Press **▶ (PLAY)**. The Random Playback will start.

- If you set "Random" during playback mode, Random playback will begin after the track that is currently being played has ended.
- To resume normal playback, select Mode "Off" in step 2.

Note:

- In case of Video CD with PBC, you cannot set Program playback.
- The program is cancelled when you eject the disc or turn the power off.
- In case of Video CD with PBC, you cannot set Random function during playback.

Customizing The Function Settings

Setting procedure

1

Press **SETUP** in stop mode.

The following on-screen display appears.

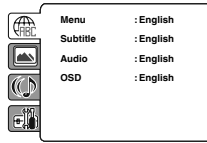

2

Press **▲** or **▼** to select the desired section, then press **▶** or **ENTER**.

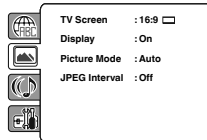

3

First option will be highlighted. Press **▲** or **▼** to select the desired option.

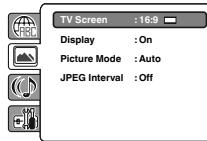

4

Then press **▶** or **ENTER**. The selectable settings will appear.

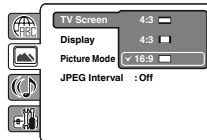

5

Change the selection using **▲** or **▼** by referring to the corresponding pages 40 ~ 42.

Press **ENTER** to save the setting.

- Repeat steps 3 and 5 to change other option.
- To select another section, go back to step 2 by pressing **◀** or **RETURN** repeatedly.

6

To clear SETUP screen, press **SETUP** or press **RETURN** repeatedly.

Setting details

Section	Option	Details	Page
	Menu	To select the language of "Menu", "Subtitle" and "Audio" if more than one languages are available on the disc.	40
	Subtitle		
	Audio		
	OSD		
	TV Screen	To select a picture size according to the aspect ratio of your TV.	41
	Display	To turn On or Off the operational status display on the screen.	
	Picture Mode	To select a preferred picture mode from "Video", "Film" or "Auto".	
	JPEG Interval	To select a preferred setting for the slide show playback.	
	Night Mode	To select On or Off for Night Mode.	41
	Digital Out	To select a digital output sound format corresponding to your system connection.	
	Parental	To select a preferred parental level for the parental setting.	42
	Password	To change the password.	

You can change the default settings to customize performance to your preference.

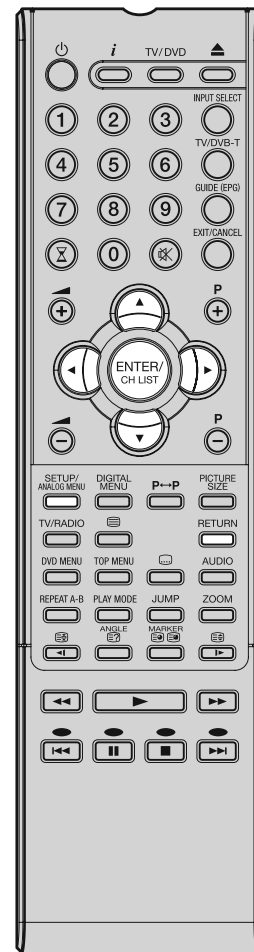

Contents

Connection and Analogue Channel Setup

Basic TV Features

Digital TV Operation

DVD Operations

Connection to Other Equipment

Fault-finding guide and Specifications

Customizing The Function Settings



Menu, Subtitle, Audio

You can select the language of "Menu", "Subtitle" and "Audio" if more than one language is recorded onto the disc.

English, Deutsch, Русский, Italiano, Espanol:

The selected language will be heard or seen.

Other:

Other languages can be selected (see "Language code list" on page 44).

Off (Subtitle):

Subtitles do not appear.

Original (Audio):

The unit will select the first priority language of each disc.

Note:

- If the selected language is not recorded on the disc, the first- priority language is selected.

	Menu	: English
	Subtitle	: English
	Audio	: English
	OSD	: English

OSD

The setup language can be selected.

- English:** To display OSD language is English
Deutsch: To display OSD language is German
Русский: To display OSD language is Russian
Italiano: To display OSD language is Italian
Espanol: To display OSD language is Spanish



TV Screen

You have the following screen sizes to choose from:

4:3 (Letterbox)

When playing back a wide screen-DVD disc, it displays the wide picture with black bands at the top and bottom of screen.

4:3 (Panscan)

It displays the wide picture on the whole screen with left and right edges automatically cut off.

16:9 (Wide screen)

A wide screen picture is displayed full size, although the image on the screen may be geometrically distorted in this mode because the TV screen has an aspect ratio of 4:3 not 16:9.

Note:

- If the DVD disc is not formatted in the pan & scan style, it displays 4:3 style.

	TV Screen	: 16:9 <input type="checkbox"/>
	Display	: On
	Picture Mode	: Auto
	JPEG Interval	: Off

Display

On screen display can be switched on or off when you press any buttons.

Off: On screen displays do not appear when you press any buttons except **PLAY MODE**, **MARKER**, **i** and **JUMP**.

On: On screen displays appear when you press the buttons (factory setting).

Customizing The Function Settings

Picture Mode

There are two types of source content in pictures recorded in DVD video discs: film content (pictures recorded from films at 24 frames per second) and video content (video signals recorded at 30 frames per second). Make this selection according to the type of content being viewed.

- Auto:** Select this selection normally. The DVD player automatically detects source content, film or video of playback source, and converts that signal in an appropriate method.
- Film:** The DVD player converts film content pictures appropriately. Suitable for playback of film content pictures.
- Video:** The DVD player filters video signal, and converts it appropriately. Suitable for playback of video content pictures.

Note:

- Depending on the disc, pictures may be cut off or doubled. In this case, select "Video".

JPEG Interval

You can continuously playback all JPEG files automatically. After the selection below, the disc will start playback on JPEG files which have been recorded.

- Off:** Plays back one file at a time.
- 5 Seconds:** Plays back images in the form of a slide show at 5 second intervals.
- 10 Seconds:** Plays back images in the form of a slide show at 10 second intervals.
- 15 Seconds:** Plays back images in the form of a slide show in 15 second intervals.

Night Mode

Night Mode enables you to control the dynamic range so as to achieve a suitable sound for your equipment.

- Off:** It plays back at the recording level on the disc.
- On:** Loud sound such as explosion is toned down slightly when played back. This is suitable when it is connected to a stereo.

Note:

- This function works only when the disc recorded with Dolby Digital is played back.
- The level of Night Mode may differ depending on DVD video disc.

Digital Out

You can select the digital output sound format corresponding to your system connection.

- Off:** There is no sound output from DIGITAL AUDIO OUT jack.
- PCM:** Change Dolby Digital to PCM for the output. Select when connected to a 2 channel digital stereo amplifier.
- Bitstream:** Disc audio bitstream data will be output.

Note:

- Even if you select "Bitstream", MPEG Audio will be output in PCM format.



	Night Mode : Off
	Digital Out : PCM

Customizing The Function Settings

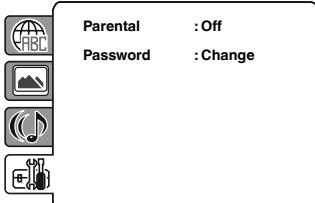

Parental

Some discs are specified as not suitable for children. Such discs can be limited not to playback with the unit.

- 1) Press **▲** or **▼** to select "Parental", then press **ENTER**. "Enter Password" screen will appear.
- 2) Press "0 0 0 0" using **Number buttons (0-9)**. (Please note, this is pre-setting password of this unit). Then press **ENTER**. The parental level list will appear.

Level 1: DVD software for adults cannot be played back.

Level 8: Virtually all DVD software can be played back.

Level Off: The parental control setting does not function.

- 3) Press **▲** or **▼** to select from the level 1 to level 8. The limitation will be more severe as the level number is lower. Then press **ENTER**.
- 4) Press **▲ (EJECT)** to activate Parental control setting.

Note:

- If each setup (pages 40~42) has been completed, the unit can always work under the same condition (especially with DVD discs).
- Each setup will be retained in the memory even if you turn the power off.
- Depending on the discs, the unit cannot limit playback.
- Some discs may not be encoded with specific rating level information though its disc jacket says "adult." For those discs, the age restriction will not work.
- The password is required every time when you change the parental level.
- If you input a wrong number, press **CANCEL**.

Password

- 1) Press **▲** or **▼** to select "Password", then press **ENTER**. "Enter Current Password" screen will appear.
- 2) Press **Number buttons (0-9)** to input the current password (If the password has not been set yet after you purchase this unit, it is "0000").
- 3) Then press **ENTER**. "Enter New Password" screen will appear. Press **Number buttons (0-9)** to input the new password.
- 4) Press **ENTER**. Now your new password has been set. Be sure to remember this number!

If you forget the password.

- 1) Press **▲ (EJECT)** to remove the disc.
- 2) While holding **7** down on the remote control and at the same time press **■ (STOP)** on the unit. "Password Clear" appears on the screen. Now the password has been returned to the initial value ("0000").

Temporary cancel the rating level by DVD disc

1

Load a DVD disc.

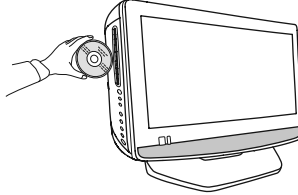

Depending on the DVD disc, the disc may try to temporarily cancel the rating level that you have set. It is up to you to decide whether to cancel the rating level or not.

2

If the DVD disc has been designed to temporarily cancel the Rating level, the screen which follows the "Reading" screen will change, depending on which disc is played. If you select "YES" with the **ENTER** key, password input screen will then appear.

3

Enter the password with **Number buttons (0-9)**. Then press **ENTER**.



To exit from the entry, press **RETURN**.

4

Playback will commence if the entered password was correct.

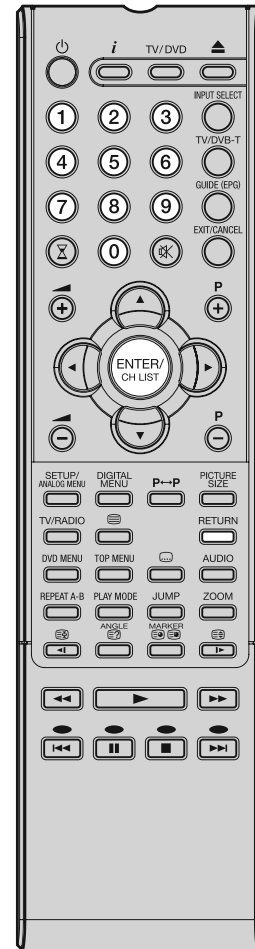

Note:

- This temporary cancellation of rating level will be kept until the disc is ejected. When the disc is ejected, the original rating level will be set again automatically.

Contents

Connection and Analogue
Channel Setup

Basic TV Features

Digital TV Operation

DVD Operations

Connection to Other
Equipment

Fault-finding guide
and Specifications

Language Code List

Enter the appropriate code number for the initial settings "Menu", "Subtitle" and/or "Audio" (see pages 40).

Language Name	Code	Language Name	Code	Language Name	Code	Language Name	Code
Abkhazian	1112	Fiji	1620	Lingala	2224	Sinhalese	2919
Afar	1111	Finnish	1619	Lithuanian	2230	Slovak	2921
Afrikaans	1116	French	1628	Macedonian	2321	Slovenian	2922
Albanian	2927	Frisian	1635	Malagasy	2317	Somali	2925
Amharic	1123	Galician	1722	Malay	2329	Spanish	1529
Arabic	1128	Georgian	2111	Malayalam	2322	Sundanese	2931
Armenian	1835	German	1415	Maltese	2330	Swahili	2933
Assamese	1129	Greek	1522	Maori	2319	Swedish	2932
Aymara	1135	Greenlandic	2122	Marathi	2328	Tagalog	3022
Azerbaijani	1136	Guarani	1724	Moldavian	2325	Tajik	3017
Bashkir	1211	Gujarati	1731	Mongolian	2324	Tamil	3011
Basque	1531	Hausa	1811	Nauru	2411	Tatar	3030
Bengali; Bangla	1224	Hebrew	1933	Nepali	2415	Telugu	3015
Bhutani	1436	Hindi	1819	Norwegian	2425	Thai	3018
Bihari	1218	Hungarian	1831	Oriya	2528	Tibetan	1225
Breton	1228	Icelandic	1929	Panjabi	2611	Tigrinya	3019
Bulgarian	1217	Indonesian	1924	Pashto, Pushto	2629	Tonga	3025
Burmese	2335	Interlingua	1911	Persian	1611	Turkish	3028
Byelorussian	1215	Irish	1711	Polish	2622	Turkmen	3021
Cambodian	2123	Italian	1930	Portuguese	2630	Twi	3033
Catalan	1311	Japanese	2011	Quechua	2731	Ukrainian	3121
Chinese	3618	Javanese	2033	Rhaeto-Romance	2823	Urdu	3128
Corsican	1325	Kannada	2124	Romanian	2825	Uzbek	3136
Croatian	1828	Kashmiri	2129	Russian	2831	Vietnamese	3219
Czech	1329	Kazakh	2121	Samoan	2923	Volapük	3225
Danish	1411	Kirghiz	2135	Sanskrit	2911	Welsh	1335
Dutch	2422	Korean	2125	Scots Gaelic	1714	Wolof	3325
English	1524	Kurdish	2131	Serbian	2928	Xhosa	3418
Esperanto	1525	Laothian	2225	Serbo-Croatian	2918	Yiddish	2019
Estonian	1530	Latin	2211	Shona	2924	Yoruba	3525
Faroese	1625	Latvian, Lettish	2232	Sindhi	2914	Zulu	3631

PC connection

As PCs are sometimes supplied with a "conventional" CRT monitor, you may need to adjust the display settings of your PC's graphics card, otherwise the pictures may not appear correctly. Switch on your PC (still with your original monitor) - select "1280x 768" for the screen resolution, and select 60 Hz for the on-screen refresh rate. Switch off your PC, then connect it to your LCD TV while both items are still switched off.

Select PC input

Switch on the LCD-TV.
Select the PC input mode (see page 5).

Note:

- If there is no video signal from the computer when the unit is in PC mode, "NO SIGNAL" will appear on the TV screen.
- Digital PC-connection via HDMI input is not supported.
If you try to connect your PC digitally anyway, the TV-operation might freeze. TV will stop to respond properly on usercommands.
- Countermeasure:** Switch-off your TV and disconnect from the 220~240V-power-supply. Disconnect the digital PC-connection. Now you may retry operating your TV.
- If a digital PC-connection does show a picture, proper working is not guaranteed. Digital PC-connection is not granted for this TV.
- Resolution 720x400 is not supported. This can therefore result in the PC-BIOS not being able to be presented.

Use a PC-VGA cable (not supplied) to connect the LCD-Monitor to your PC. Make the connections carefully so as not to break or bend the contacts inside the plug.

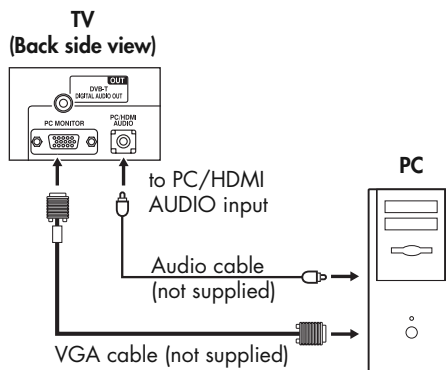

Example: Adjust the contrast.

1

During PC mode press **ANALOG MENU**. The Menu will appear on the screen.

BRIGHTNESS	25
CONTRAST	40
HOR POSITION	0
VER POSITION	0
PHASE	25
CLOCK	0

2

Select **CONTRAST**, then press **ENTER**. Press ◀ or ▶ to adjust **CONTRAST**.

3

Press **EXIT** to return to the normal screen.

Monitor Display modes

MODE	Resolution	Refresh rate
VGA	640x480	60Hz
SVGA	800x600	60Hz
XGA	1024x768	60Hz
WXGA	1280x720	60Hz
WXGA	1280x768	60Hz
WXGA	1360x768	60Hz

(according to Graphic card)

Description about the each setting option:

PICTURE Menu

BRIGHTNESS and CONTRAST: You can adjust these according to your personal preferences.
HOR POSITION and VER POSITION: to adjust the horizontal and vertical placing of the image.
PHASE and CLOCK: eliminates the horizontal (PHASE) and vertical (CLOCK) interfering lines.
RED/GREEN/BLUE: influences the colour balance.
BACKLIGHT: Press ◀ or ▶ to adjust the level you require.
WXGA INPUT: When you input an WXGA signal, set this option to "ON".
RESET: Press **ENTER** to reset BRIGHTNESS, CONTRAST, RED, GREEN, BLUE and BACKLIGHT to the factory preset values.

AUDIO Menu

BASS/TREBLE/BALANCE: Tone setting menu.
RESET: Press **ENTER** to reset BASS, TREBLE and BALANCE to the factory preset values.

Connecting an HDMI or a DVI device to the HDMI input

The HDMI input receives digital audio and uncompressed video from a HDMI equipped device or uncompressed digital video from a DVI equipped device.

When you connect to a DVI device with a HDMI-to-DVI adapter cable, it only transfers the video signal, so it is necessary to use separate analogue leads to transfer the audio signals. Select the HDMI input mode (see page 5).

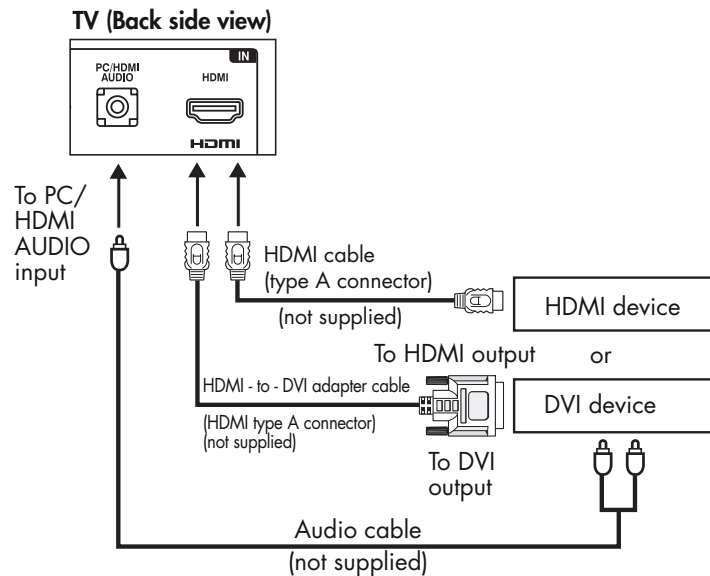

Selecting the HDMI audio input source

You must choose the appropriate HDMI audio input setting for each connection, depending on whether the source is equipped with a DVI or HDMI socket.

1

Select **HDMI AUDIO** then press **ENTER**. Press **◀** or **▶** to select HDMI or DVI.

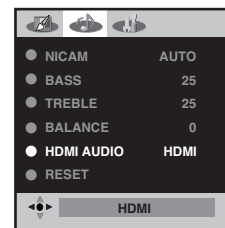

2

Press **EXIT** to return to the normal screen.

Note:

- Follow the user's manual that came with the HDMI-system, which you try to connect to this TV.
- If there is no picture available via HDMI-connection, do connect via SCART-cable first. Use the HDMI-system's remote-control to call the HDMI-system's setup-menu onto the screen.
- Follow the HDMI-system's manual, to set its video-output to HDMI.
- When successfully set to HDMI, select this TV's HDMI-input, as described in here on page 5 (Select Video Input).

Note:

- This set is classed as "HD-Ready". This means that it is capable of displaying HD (High Definition) signals when connected to a suitable HD source, such as an HD receiver or DVD player that has HD capability, via HDMI, DVI, or Component Video connections.
- Some devices may not operate properly with the TV.

HDMI™

HDMI, the HDMI logo and High-Definition Multimedia Interface are trademarks or registered trademarks of HDMI Licensing LLC.

Connection to other equipment

1. Connecting other units to your TV

Caution. Before connecting:

- Make sure to disconnect the appliance from the power supply in order to avoid any potential damage from occurring.
- Make sure to establish the required connection.
- Make sure that connections are properly and correctly attached before connecting the appliances to the power supply.

Connect with Satellite receiver as shown below. Select the TV-Program at the satellite receiver. To do this, use the remote control of the satellite receiver. You can not store the same station once again additionally in LCD-Monitor which already stored in satellite receiver.

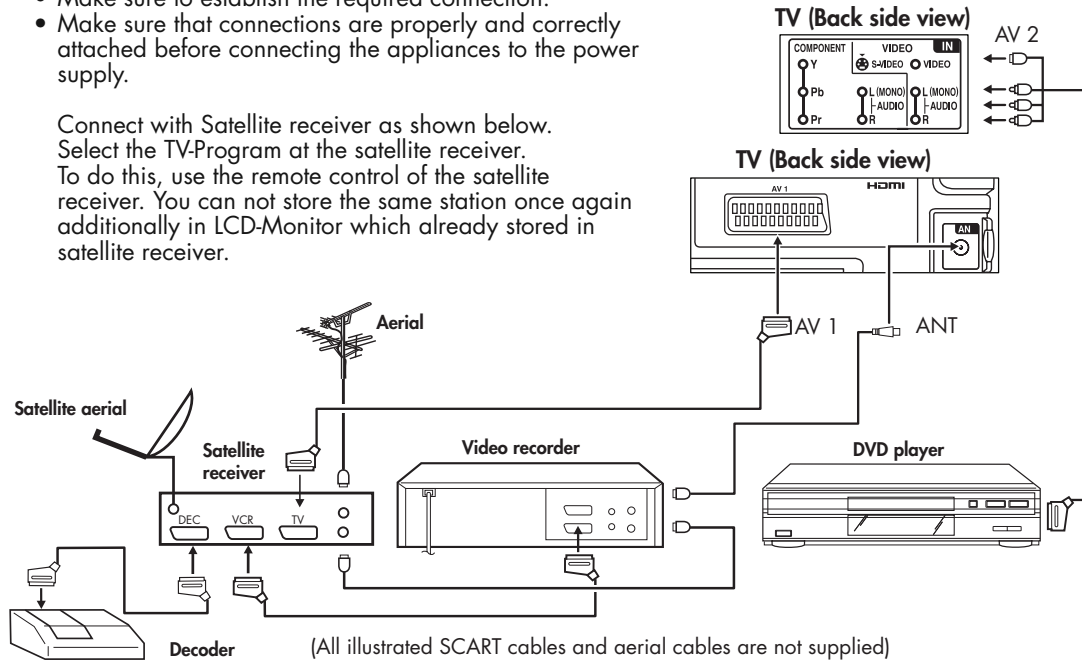

Note:

- S-Video signals can be played back through the AV 2 input (see page 49).

2. Connecting a DVD player

TV (Back side view)

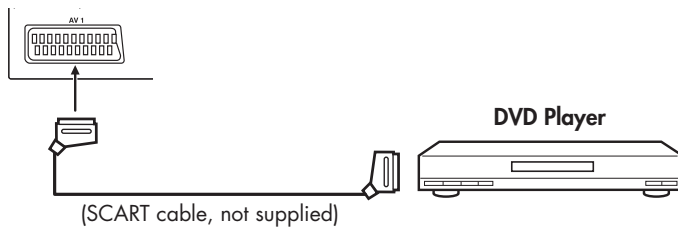

For to ensure optimum picture quality, select RGB for the DVD player's output signal (see Owner's manual of the DVD player). AV 1 SCART is compatible with RGB signal. Select AV 1 input mode to view (see page 5).

Connection to other equipment

3. Connecting an audio system

You can supply the TV sound to the stereo equipment with the scart socket. Use a special scart cable for the connection which sold at the accessory shop. (please consult your hi-fi instructions for details).

Note:

- The Bass/Treble/Balance adjustments (see page 21) only function with the sound from the TV speakers - it does not affect the audio output sockets.

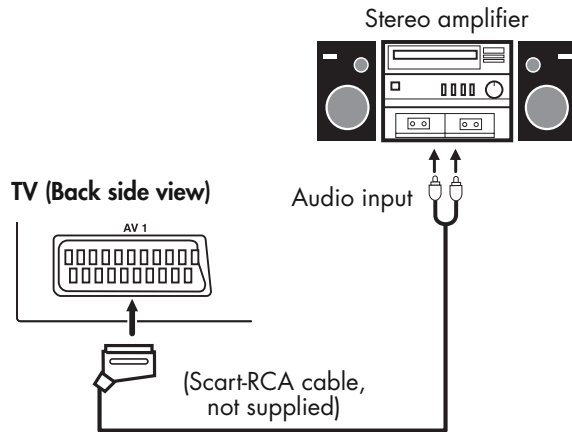

4. Connection of a digital amplifier or digital A/V receivers (with DTS or Dolby Digital Decoder)

DTS and Dolby Digital are two different systems. DTS-DVDs cannot be played with a Dolby Digital receiver. Please use in this case a decoder that matches your DVDs.

Note:

- In earlier years Dolby Digital was known as AC-3. Nowadays only the name has changed. To enjoy Dolby Digital you may still use your "old" AC-3 decoder. Also the commercially available AC-3 DVDs can still be played with any Dolby Digital DVD player.

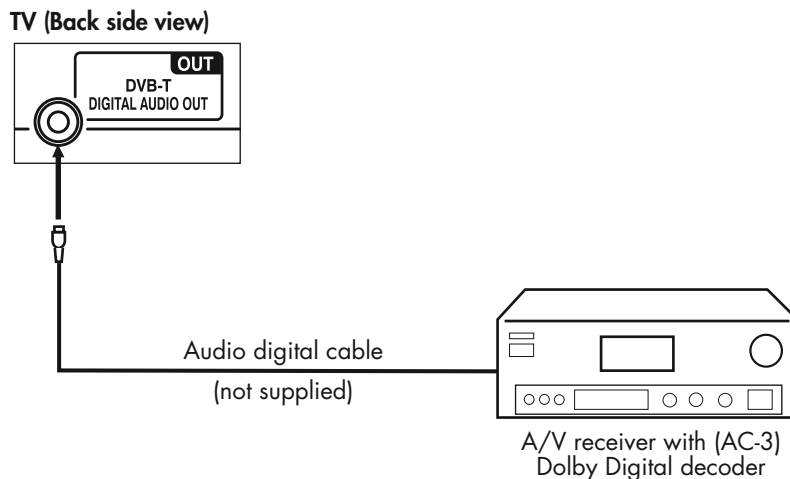

- After connecting a DD decoder please select in the DVD menu the Dolby Digital (DD) sound track option.
- Several DVDs may be pre-recorded on both sides however only one side contains the DD sound track. Please insert the correct DVD side.
- When a DTS sound track is played the integrated loudspeakers are mute. The DTS sound can only be played digitally using the digital outlet. For hearing a DTS decoder is necessary.
- Digital audio output is active only when receiving DVB-T, not when receiving analogue cable TV broadcasting.

Connection to other equipment

5. Connecting Video camera and Video recorder

Select the "MONITOR" option in the SETUP menu (see No.7 on page 50).
 Select the AV 2 input mode (see page 5). You can see the playback picture from video camera.
 This signal is output via AV 1 and can be recorded by video recorder.
 With this arrangement, Video recorder will record exactly what is shown on the screen.

Note:

- If you have a camcorder with S-video, use an S-video cable instead of a standard video cable. Do not connect both a standard video cable and an S-video cable at the same time, or the picture performance will be unacceptable.
- When you input the PAL-M signal to AV 2 input, select AV COLOUR setting to AUTO, otherwise the monochrome images will be displayed.

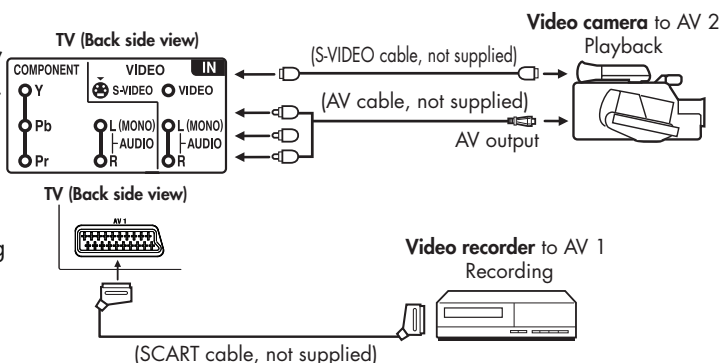

6. Connecting to a DVD player or other AV device with Component Video outputs

If your DVD player (or other device) has Component Video output jacks, use a suitable set of leads (RCA/Phono) to connect these to the Component Video inputs on this TV as shown - it can greatly enhance the picture quality and performance. Please remember that you will also need to connect separate leads (RCA/Phono) for the audio signals. Select the COMPONENT input mode (see page 5).

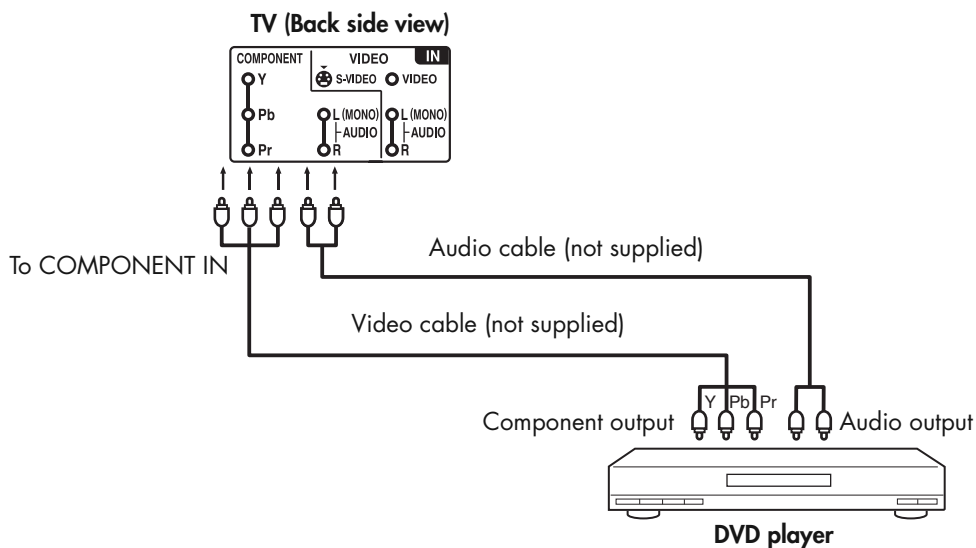

Note:

- The Component Video input of this unit are for use with equipment which outputs interlaced signals (PAL: 576i/1080i or NTSC: 480i/1080i) and progressive signals (PAL: 576p/720p or NTSC: 480p/720p).



Connection to other equipment

7. Setting of Scart socket

1

In , select AV1 OUTPUT, then press **ENTER**.

2

This determines whether the AV1 outputs the signal from the internal tuner or whatever input is shown on the screen.

Press ◀ or ▶ to select TV or MONITOR.

TV: Outputs the last channel position selected.

MONITOR: The picture displayed on TV-screen.

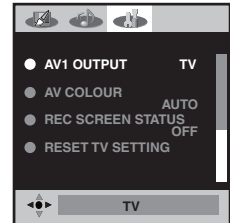

3

Press **EXIT** to return to the normal screen.

AV colour adjustment

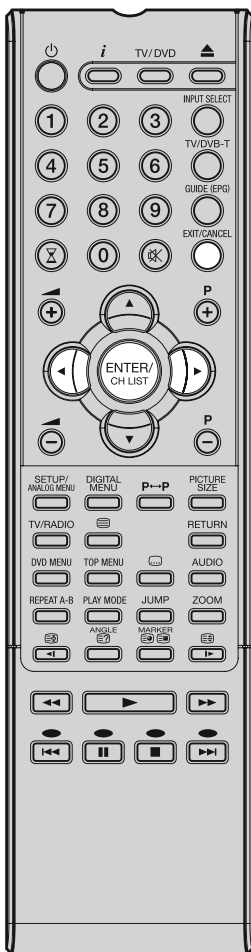

The AV Colour setting only applies when viewing devices connected to the AV inputs.

1

In , select AV COLOUR, then press **ENTER**.

2

Press ◀ or ▶ to select AUTO.

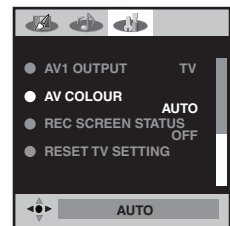

3

If AUTO option does not work, press ◀ or ▶ to select desired colour (e.g. NTSC 3.58).

4

Press **EXIT** to return to the normal screen.

Note:

- PAL is the colour system used in UK. NTSC 3.58 is used in the USA, PAL 60 used in UK by some video recorders, which play NTSC video tape recording.

If the picture shows horizontal stripes:

Set to AUTO as the description above.



Fault finding guide

If the problem still exists after checking the points on this page, you can call the Orion Helpline for advice - details on the next page.

SYMPTOMS	CAUSE	SOLUTION	PAGE
POWER			
TV does not operate.	Internal error may occur.	Unplug the unit for 1 minute, then plug it back in.	-
No power.	The Mains lead is disconnected.	Connect the Mains lead to the AC outlet.	3
	Main power (ON) switch is OFF.	Set it to ON.	2
TV BROADCAST RECEPTION			
No picture, no sound.	The Mains lead is disconnected.	Connect the Mains lead to the AC outlet.	3
	Aerial connector is not connected or wires are broken.	Check aerial connections or broken wires.	3
	Sub ⏻ (Power) button is off.	Press the ⏻ (Power) button.	2
	Possibly station trouble.	Try another channel.	8
Sound OK, poor picture.	Possibly station trouble.	Try another channel.	8
	Aerial connector is not connected or wires are broken.	Check aerial connections or broken wires.	3
	Possibly local interference.	Move the aerial away from the source of interference.	-
Picture OK, poor sound.	Possibly station trouble.	Try another channel.	8
	Possibly local interference.	Move the aerial away from the source of interference.	-
	Volume control set at minimum position.	Increase VOLUME control.	8
Poor reception.	Aerial connector is not connected or wires are broken.	Check aerial connections or broken wires.	3
	Possibly station trouble.	Try another channel.	8
Poor colour or no colour.	Aerial connector is not connected or wires are broken.	Check aerial connections or broken wires.	3
	Possibly station trouble.	Try another channel.	8
	Possibly local interference.	Move the aerial away from the source of interference.	-
	Colour control is not adjusted.	Adjust the colour settings.	12
While viewing a DVB (digital) channel, there is sound but no picture.	Received channel has audio content only.	Some channels offer audio content only. It is normal.	20
Blocky image or image stops intermittently.	Digital signal strength is low.	Check all aerial connections. Move the aerial away from areas of possible interference. Try using an aerial booster.	-
Some digital channels cannot be viewed.	Some channels are encrypted and are only available via subscription.	Contact the service provider to subscribe.	-
"Database empty" message appears on the screen.	The auto tuning process has not been successful.	Check all aerial connections and try auto tuning again.	3
No sound when connecting to external source via HDMI to DVI lead.	Audio leads have not been connected.	Ensure that separate audio leads are connected to the relevant audio input socket.	45

Fault finding guide

If the problem still exists after checking the points on this page, you can call the Orion Helpline for advice - details below.

SYMPTOMS	CAUSE	SOLUTION	PAGE
DVD			
The playback picture has occasional distortion.	The disc is dirty.	Eject the disc and clean it.	24
	It is in fast forward or fast reverse playback.	Some times a small amount of picture distortion may appear. This is not a malfunction.	-
The unit does not start playback.	No disc is inserted.	Insert a disc.	25
	An unplayable disc is inserted.	Insert a playable disc (Check the disc type and colour system).	24
	The disc is placed with the label side facing backward.	Place the disc in the disc slot with the label side facing forward.	25
	The disc is dirty.	Clean the disc.	24
	The parental lock function is set.	Cancel the parental lock function or change the parental lock level.	42
Playback does not follow the course of the disc's program.	It is in the mode of repeat playback, memory playback, etc.	These operations may prevent a proper progress of the contents.	-
X appears on the screen.	The function is prohibited with the unit or the disc.	-	25
REMOTE CONTROL			
Remote control does not work.	It is not aimed at the remote sensor.	Aim it at the remote control sensor.	-
	Distance too far or there is too much light in the room.	Operate within 5 metres and reduce the light of the room.	-
	Obstacle in the path of beam.	Clear the path of the beam.	-
	Batteries are weak.	Replace batteries.	-
	Polarities of the batteries, + or -, are not inserted correctly.	Install batteries correctly.	-

* This product incorporates copyright protection technology that is protected by U.S. patents and other intellectual property rights. Use of this copyright protection technology must be authorized by Macrovision, and is intended for home and other limited viewing uses only unless otherwise authorized by Macrovision. Reverse engineering or disassembly is prohibited.

* Manufactured under license from Dolby Laboratories. "Dolby" and the double-D symbol are trademarks of Dolby Laboratories.

* Manufactured under license under U.S. Patent #: 5,451,942 & other U.S. and worldwide patents issued & pending. DTS and DTS Digital Out are registered trademarks and the DTS logos and Symbol are trademarks of DTS, Inc. © 1996-2007 DTS, Inc. All Rights Reserved.

* Unauthorized recording of copyrighted television programs, films, video cassettes and other materials may infringe the rights of copyright owners and be contrary to copyright laws.

If you have a problem with setting up or operating your Orion product, you can call the **Orion Helpline** on **020 8236 9090** (Mon-Fri, 9am-5pm).

Please note: This is for operating problems and not for Service or Technical enquiries (see back cover for After Sales Service information).

Specifications

TELEVISION

Colour System	PAL, SECAM
System:	Analogue: PAL UK, IR, CCIR, FRENCH System, B/G, D/K, I/I, L Digital: DVB-T (OFDM 2k/8k 16QAM/64QAM) AV Input receivable: NTSC 3.58, NTSC 4.43/PAL 60
Preset channels:	Analogue channels (99) + Digital channels (Carrier 200/Service1000)
Frequency Range:	Analogue: IreE2~E4, X~Z+2, S1~S10, E5~E12, S11~S41, E21~E69 Digital: E5~E12, ItaE~G, F1~F6, Rus6~12, E21~E69
LCD:	21.6" TYPE (54.8 cm visible) TFT low-glass Active Matrix Colour LCD, 1680 x 1050 Pixel
Terminals	Aerial input: UHF/VHF 75Ω Din type (Analogue Digital) AV 1: SCART (AV input/output, RGB input, TV output) AV 2: S-VIDEO (Y/C input), RCA pin (AV input) COMPONENT: COMPONENT (Y/Pb (Cb)/Pr (Cr) input), RCA (Audio input) HDMI: HDMI, Ø 3.5 mm jack (Audio input*) PC: Ø 3.5 mm jack (Audio input*), 15 pin mini D-sub (PC/Component) C. I. (Common Interface): EN50221 DIGITAL AUDIO OUTPUT: RCA pin (Audio) Headphones: Ø 3.5 mm jack (Audio output) * Audio input that share with HDMI and PC.
Audio Output Power:	1.5W x 2 (MAX)

DVD

Signal system:	NTSC, PAL
Applicable disc:	DVD (12cm, 8cm), CD (12cm, 8cm)
Frequency response:	DVD: 4Hz - 22KHz, CD: 4Hz - 20KHz
S/N Ratio:	85dB
Harmonic distortion:	0.02%
Output:	Audio : (RCA) -12.0 dBm, 1 k ohm Digital Audio : 0.5Vp-p/75 ohm
Pickup:	CD : Wavelength: 775 - 805 nm Maximum output power: 0.5 mW DVD : Wavelength: 640 - 660 nm Maximum output power: 1.0 mW

GENERAL

Power Source:	AC 220~240V, 50Hz
Power Consumption:	65 W (at Standby: 1W)
Weight:	5.8 kg
Dimensions:	536.5(W)x439.5(H)x207(D)mm
Operating Temperature:	5°C to 40°C

REMOTE CONTROL UNIT

Power Supply:	DC 3V (Two batteries, AA/ R6/ UM-3)
---------------	-------------------------------------

Weight and Dimensions are approximate. Because we continually strive to improve our products we may change specifications and designs without prior notice.

Contents

Connection and Analogue
Channel Setup

Basic TV Features

Digital TV Operation

DVD Operations

Connection to Other
Equipment

Fault finding guide
and specifications



After Sales Service

Whilst Orion products have been designed and manufactured to a very high standard and have been subjected to rigorous quality control, regrettably problems can sometimes occur.

In the unlikely event of a manufacturing defect occurring during the first twelve months of ownership, your dealer, Mail Order or Catalogue Company, from whom you purchased the product, will arrange for free-of-charge service to be carried out. However as this may NOT include a home visit, please ensure that you have received details of their respective service procedures and policy at the time of purchase.

Free-of-charge service covers the product for domestic use only, and does not cover any fault or defect caused by accident, misuse, lightning strike, fire or water damage, neglect, connection to an incorrect mains voltage or inadequate aerial, cable or satellite installation.

None of the foregoing comments or statements affect your Statutory Rights as currently provided for by law in the United Kingdom.

If you have a problem with setting up or operating your Orion product, you can call the **Orion Helpline** on **020 8236 9090** (Mon-Fri, 9am-5pm).

Please note: This is for operating problems and not for Service or Technical enquiries.



Electrical and electronic equipment should never be disposed of with general household waste but must be separately collected for their proper treatment and recovery.

The crossed out bin symbol, placed on the product, reminds you of the need to dispose of the product correctly at the end of its life.

In this way you will assist in the recovery, recycling and reuse of many of the materials used in this product.

Where possible recycle your packaging.

With your help it is possible to reduce the amount of electrical and electronic waste ending up in landfill and to improve quality of life by preventing the release of potentially hazardous substances into the environment.



J51B0201A SH 08/07

