

NEC

LCD Projector

MultiSync LT156/155/LT154

User's Manual



LIMITED WARRANTY (USA and Canada only)

NEC SOLUTIONS' PROJECTOR PRODUCTS

NEC Solutions (America), Inc. (hereafter NEC Solutions) warrants this product to be free from defects in material and workmanship under the following terms.

HOW LONG IS THE WARRANTY

NEC Solutions' LT156, LT155 and LT154 projectors are covered by a three (3) year limited parts and labor warranty from the date of the first customer purchase. The lamp when used under normal operating conditions is warranted for 1000 hours or six months, whichever comes first.

WHO IS PROTECTED

This warranty may be enforced only by the first purchaser, and is not transferable.

WHAT IS COVERED AND WHAT IS NOT COVERED

Except as specified below, this warranty covers all defects in material or workmanship in this product.

NEC SOLUTIONS' LIABILITY FOR ANY DEFECTIVE PRODUCT IS LIMITED TO THE REPAIR OR REPLACEMENT OF THE PRODUCT AT NEC SOLUTIONS' OPTION. REPLACEMENT PRODUCTS MAY BE NEW OR 'LIKE NEW'. The following are not covered by the limited warranty and NEC Solutions shall not be liable for:

1. Any product which is not distributed in the U.S.A. or Canada by NEC Solutions or which is not purchased, installed, and operated in the U.S.A or Canada.
2. Any product on which the serial number has been defaced, modified or removed.
3. Normal decrease in lamp light output over time.
4. Damage, deterioration or malfunction resulting from:
 - a. Accident, misuse, abuse, neglect, improper ventilation, fire, dust, smoke, water, lightning or other acts of nature, unauthorized product modification, or failure to follow instructions supplied with the product.
 - b. Repair or attempted repair by anyone other than a NEC Solutions authorized service center.
 - c. Any shipment of the product (claims must be presented to the carrier).
 - d. Removal or installation of the product.
 - e. Any other cause which does not relate to a product defect.
 - f. Use of the product beyond normal operating conditions. Normal operating conditions are defined as product use not in excess of 5 hours per day and 260 days per year.
5. Cartons, carrying cases, shipping cases, batteries, external cabinets, magnetic tapes, or any accessories used in connection with the product.
6. Service required as a result of third party components.

WHAT NEC SOLUTIONS WILL PAY FOR

NEC Solutions will pay labor and material expenses for covered items, but NEC Solutions will not pay for the following:

1. Removal or installation charges.
2. Costs of technical adjustments, set-up, maintenance, or adjustment of user controls.
3. Payment of shipping and related charges incurred in returning the product for warranty repair.

HOW YOU CAN GET WARRANTY SERVICE

1. To obtain service on your product, consult the dealer from whom you purchased the product.
2. Whenever warranty service is required, the original dated invoice (or a copy) must be presented as proof of warranty coverage. In order to obtain warranty service, you may be required to describe and demonstrate the problem to your dealer or to NEC Solutions.
3. All products returned to NEC Solutions for service MUST have prior approval. To receive approval or for the name of the nearest NEC Solutions authorized service center, call NEC Solutions at 800-836-0655.
4. It shall be your obligation and expense to ship the product, freight prepaid, or to deliver it to a NEC Solutions authorized service center, in either the original package or a similar package affording an equal degree of protection.
5. In the event a product is returned to NEC Solutions for warranty service, and it is determined that there is no product defect or that the product condition is not covered by this limited warranty, a diagnostic service fee may be charged to the customer.

LIMITATION OF IMPLIED WARRANTIES

EXCEPT AS EXPRESSLY SET FORTH IN THIS LIMITED WARRANTY, NEC SOLUTIONS MAKES NO OTHER WARRANTIES, EXPRESS OR IMPLIED, INCLUDING BUT NOT LIMITED TO ANY IMPLIED WARRANTIES OR CONDITIONS OF MERCHANTABILITY AND FITNESS FOR A PARTICULAR PURPOSE. ANY IMPLIED WARRANTIES THAT MAY BE IMPOSED BY LAW ARE LIMITED TO THE TERMS AND DURATION OF THIS LIMITED WARRANTY.

EXCLUSION OF DAMAGES

NEC SOLUTIONS' LIABILITY FOR ANY DEFECTIVE PRODUCT IS LIMITED TO THE REPAIR OR REPLACEMENT OF THE PRODUCT AT NEC SOLUTIONS' OPTION. NEC SOLUTIONS SHALL NOT BE LIABLE FOR:

1. DAMAGE TO OTHER PROPERTY CAUSED BY ANY DEFECTS IN THIS PRODUCT, DAMAGES BASED UPON INCONVENIENCE, LOSS OF USE OF THE PRODUCT, LOSS OF TIME, COMMERCIAL LOSS; OR
2. ANY OTHER DAMAGES, WHETHER INCIDENTAL, CONSEQUENTIAL OR OTHERWISE.

HOW STATE LAW RELATES TO THE WARRANTY

SOME STATES DO NOT ALLOW LIMITATIONS ON HOW LONG AN IMPLIED WARRANTY LASTS AND/OR DO NOT ALLOW THE EXCLUSION OR LIMITATION OF INCIDENTAL OR CONSEQUENTIAL DAMAGES, SO THE ABOVE LIMITATIONS AND EXCLUSIONS MAY NOT APPLY TO YOU. THIS LIMITED WARRANTY GIVES YOU SPECIFIC LEGAL RIGHTS, AND YOU MAY HAVE OTHER RIGHTS WHICH VARY FROM STATE TO STATE.

FOR MORE INFORMATION, CONTACT:

NEC SOLUTIONS (AMERICA), INC.
1250 N. Arlington Heights Road, Suite 500
Itasca, Illinois 60143-1248
TELEPHONE 800-836-0655
www.necvisualsystems.com

Customers are cautioned that product performance is affected by system configuration, software, the application, customer data, and operator control, among other factors. While NEC Solutions' products are considered to be compatible with many systems, the specific functional implementation by the customers of the product may vary. Therefore, the suitability of a product for a specific purpose or application must be determined by the customer and is not warranted by NEC Solutions.

DECLARATION OF CONFORMITY

This device complies with Part 15 of FCC Rules. Operation is subject to the following two conditions. (1) This device may not cause harmful interference, and (2) this device must accept any interference received, including interference that may cause undesired operation.

U.S. Responsible Party:	NEC Technologies, Inc.
Address:	1250 N. Arlington Heights Road Itasca, Illinois 60143
Tel. No.:	(630) 467-5000

Type of Product: LCD Projector
Equipment Classification: Class B Peripheral
Models: LT156, LT155 and LT154

*We hereby declare that the equipment specified above
conforms to the technical standards as specified in the FCC Rules.*



.....

MultiSync LT156/LT155/LT154
LCD Projector
User's Manual

.....

English

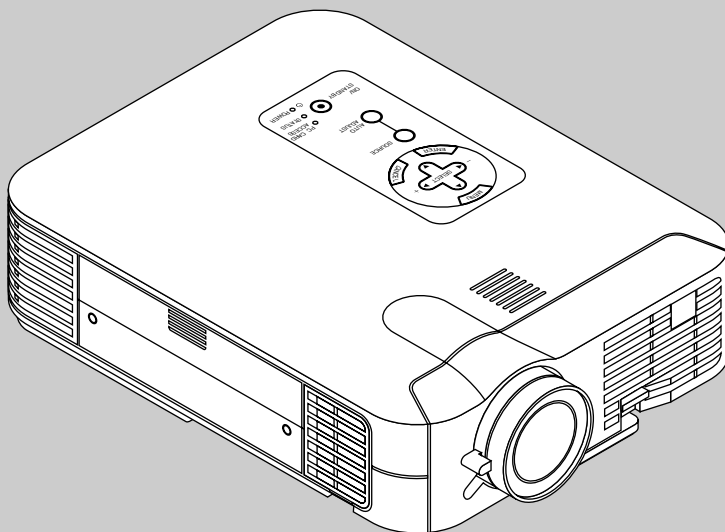



IMPORTANT INFORMATION

Precautions

Please read this manual carefully before using your NEC MultiSync LT156/LT155/LT154 Projector and keep the manual handy for future reference.

Your serial number is located under the name plate label on the bottom of your MultiSync LT156/LT155/LT154. Record it here:

CAUTION	
	<p>To turn off main power, be sure to remove the plug from power outlet.</p> <p>The power outlet socket should be installed as near to the equipment as possible, and should be easily accessible.</p>

CAUTION	
	<p>TO PREVENT SHOCK, DO NOT OPEN THE CABINET. NO USER-SERVICEABLE PARTS INSIDE.</p> <p>REFER SERVICING TO QUALIFIED NEC SERVICE PERSONNEL.</p>

	<p>This symbol warns the user that uninsulated voltage within the unit may be sufficient to cause electrical shock. Therefore, it is dangerous to make any kind of contact with any part inside of the unit.</p>
---	--

	<p>This symbol alerts the user that important information concerning the operation and maintenance of this unit has been provided. The information should be read carefully to avoid problems.</p>
--	--

WARNING

TO PREVENT FIRE OR SHOCK, DO NOT EXPOSE THIS UNIT TO RAIN OR MOISTURE.

DO NOT USE THIS UNIT'S GROUNDED PLUG WITH AN EXTENSION CORD OR IN AN OUTLET UNLESS ALL THREE PRONGS CAN BE FULLY INSERTED.

DO NOT OPEN THE CABINET. THERE ARE HIGH-VOLTAGE COMPONENTS INSIDE. ALL SERVICING MUST BE DONE BY QUALIFIED NEC SERVICE PERSONNEL.

DOC Compliance Notice

This Class B digital apparatus meets all requirements of the Canadian Interference-Causing Equipment Regulations.

3. GSGV Acoustic Noise Information Ordinance:

The sound pressure level is less than 70 dB (A) according to ISO 3744 or ISO 7779.

CAUTION		RADIACION LASER NO MIRE AL RAYO PRODUCTO LASER CLASSE2	REMOTE CONTROL MODEL: RD-367E 7N900012
	<p>LASER RADIATION- DO NOT STARE INTO BEAM</p> <p>WAVE LENGTH: 650nm MAX. OUTPUT: 1mW CLASS 2 LASER PRODUCT</p>	<p>LASER-STRAHLUNG NICHT IN DEN STRAHL BLICKEN I LASER KLASSE2</p>	
<p>レーザー光 ビームをのぞき込まないこと 最大出力:1mW レーザーダイオード:650nm</p>		<p>RAYONNEMENT LASER NE PAS REGARDER DANS LE FAISCEAU APPAREIL A LASER DE CLASSE2</p>	
		EN60825-1 : 1994 + A11 : 1996	MADE IN CHINA

This label is located on the back of the remote control.

RF Interference

WARNING

The Federal Communications Commission does not allow any modifications or changes to the unit EXCEPT those specified in this manual. Failure to comply with this government regulation could void your right to operate this equipment.

This equipment has been tested and found to comply with the limits for a Class B digital device, pursuant to Part 15 of the FCC Rules. These limits are designed to provide reasonable protection against harmful interference in a residential installation. This equipment generates, uses, and can radiate radio frequency energy and, if not installed and used in accordance with the instructions, may cause harmful interference to radio communications. However, there is no guarantee that interference will not occur in a particular installation. If this equipment does cause harmful interference to radio or television reception, which can be determined by turning the equipment off and on, the user is encouraged to try to correct the interference by one or more of the following measures:

- Reorient or relocate the receiving antenna.
- Increase the separation between the equipment and receiver.
- Connect the equipment into an outlet on a circuit different from that to which the receiver is connected.
- Consult the dealer or an experienced radio / TV technician for help.

In UK, a BS approved power cable with moulded plug has a Black (five Amps) fuse installed for use with this equipment. If a power cable is not supplied with this equipment please contact your supplier.

- IBM is a registered trademark of International Business Machines Corporation.
- Macintosh and PowerBook are registered trademarks of Apple Computer, Inc.
- Other product and company names mentioned in this user's manual may be the trademarks of their respective holders.

Important Safeguards

These safety instructions are to ensure the long life of your projector and to prevent fire and shock. Please read them carefully and heed all warnings.

Installation

1. For best results, use your projector in a darkened room.
2. Place the projector on a flat, level surface in a dry area away from dust and moisture.
3. Do not place your projector in direct sunlight, near heaters or heat radiating appliances.
4. Exposure to direct sunlight, smoke or steam can harm internal components.
5. Handle your projector carefully. Dropping or jarring can damage internal components.
6. Do not place heavy objects on top of the projector.
7. **If you wish to have the projector installed on the ceiling:**
 - a. **Do not attempt to install the projector yourself.**
 - b. The projector must be installed by qualified technicians in order to ensure proper operation and reduce the risk of bodily injury.
 - c. In addition, the ceiling must be strong enough to support the projector and the installation must be in accordance with any local building codes.
 - d. Please consult your dealer for more information.

Power Supply

1. The projector is designed to operate on a power supply of 100-120 or 200-240 V 50/60 Hz AC. Ensure that your power supply fits this requirement before attempting to use your projector.
2. Handle the power cable carefully and avoid excessive bending. A damaged cord can cause electric shock or fire.
3. If the projector is not to be used for an extended period of time, disconnect the plug from the power outlet.

Cleaning

1. Unplug the projector before cleaning.
2. Clean the cabinet periodically with a damp cloth. If heavily soiled, use a mild detergent. Never use strong detergents or solvents such as alcohol or thinner.
3. Use a blower or lens paper to clean the lens, and be careful not to scratch or mar the lens.

CAUTION

Do not unplug the power cable from the wall outlet under any one of the following circumstances. Doing so can cause damage to the projector:

- While the Hour Glass icon appears.
- While the message "Please wait a moment." appears. This message will be displayed after the projector is turned off.
- Immediately after the power cable is plugged into the wall outlet (the POWER indicator has not changed to a steady orange glow).
- Immediately after the cooling fan stops working (The cooling fan continues to work for ONE minute after the projector is turned off with the POWER button).
- While the POWER and the STATUS indicators are alternately flashing.

CAUTION

Do not put the projector on its side when the lamp is turned on. Doing so may cause damage to the projector.

Lamp Replacement

- To replace the lamp, follow all instructions provided on page E-48.
- Be sure to replace the lamp when the message "**The Lamp has reached the end of its usable life. Please replace the lamp.**" appears. If you continue to use the lamp after the lamp has reached the end of its usable life, the lamp bulb may shatter, and pieces of glass may be scattered in the lamp case. Do not touch them as the pieces of glass may cause injury. If this happens, contact your NEC dealer for lamp replacement.
- Allow a minimum of ONE minute to elapse after turning off the projector. Then disconnect the power cable and allow 60 minutes to cool the projector before replacing the lamp.

Fire and Shock Precautions

1. Ensure that there is sufficient ventilation and that vents are unobstructed to prevent the build-up of heat inside your projector. Allow at least 3 inches (10 cm) of space between your projector and a wall.
2. Prevent foreign objects such as paper clips and bits of paper from falling into your projector. Do not attempt to retrieve any objects that might fall into your projector. Do not insert any metal objects such as a wire or screwdriver into your projector. If something should fall into your projector, disconnect it immediately and have the object removed by a qualified NEC service personnel.
3. Do not place any liquids on top of your projector.
 - Do not look into the lens while the projector is on. Serious damage to your eyes could result.
 - Keep any items such as magnifying glass out of the light path of the projector. The light being projected from the lens is extensive, therefore any kind of abnormal objects that can redirect light coming out of the lens, can cause unpredictable outcome such as fire or injury to the eyes.
 - Do not cover the lens with the supplied lens cap or equivalent while the projector is on. Doing so can lead to melting of the cap and possibly burning your hands due to the heat emitted from the light output.
 - Do not look into the laser pointer while it is on and do not point the laser beam at another person. Serious injury could result.

TABLE OF CONTENTS

1. INTRODUCTION

Introduction to the MultiSync LT156/LT155/LT154 Projector	E-5
Getting Started	E-5
What's in the Box	E-6
Getting to Know Your MultiSync LT156/LT155/LT154 Projector	E-7
Front / Side Features	E-7
Attaching the lens cap	E-7
Rear / Side Features	E-8
Top Features	E-9
Terminal Panel Features	E-10
Remote Control Features	E-11
Remote Control Battery Installation	E-13
Operating Range	E-13
Remote Control Precautions	E-13
Using Remote Mouse Receiver	E-14
Switching Operation mode between mouse and projector	E-15

2. INSTALLATION

Setting Up Your Projector	E-16
Selecting a Location	E-16
Screen and Projection Distance	E-16
Distance Chart	E-17
Reflecting the Image	E-17
Wiring Diagram	E-18
Connecting Your PC	E-19
Connecting Your Macintosh Computer	E-20
Connecting Your DVD Player	E-21
Connecting Your VCR or Laser Disc Player	E-22
About Startup screen (Menu Language Select screen)	E-23

3. OPERATION

Connecting the Power Cable and Turn on the Projector	E-24
Basic Operation	E-27
Using the Menus	E-29
Customizing Basic/Custom Menu	E-29
Using a USB Mouse	E-30
Menu Tree	E-31
Menu Elements	E-32
Menu Descriptions & Functions	E-33
Source Select	E-33
RGB (DVI on LT156 only)/Video/S-Video/PC Card Viewer	E-33
Picture	E-33
Brightness/Contrast/Color/Hue/Sharpness	E-33
Volume	E-33
Image Options	E-34
Keystone	E-34
Color Temperature	E-34
Lamp Mode	E-34
Gamma Correction	E-34
Aspect Ratio	E-34
Noise Reduction	E-35
Color Matrix	E-35
White Balance	E-35
Position/Clock	E-35
Resolution	E-35
Video Filter	E-35
Factory Default	E-36
Projector Options	E-36
Menu	E-36
Menu Mode	E-36
Advanced Menu, Basic/Custom Menu	E-36
Language	E-36
Projector Pointer	E-36
Source Display	E-36
Direct Button (Volume Bar and Keystone Bar)	E-36
Menu Display Time	E-36

Setup	E-37
Orientation	E-37
Background	E-37
Mouse Settings	E-37
Button/Sensitivity	E-37
PC Card Viewer Options	E-37
Capture Options	E-37
Signal Select	E-37
Auto Adjust (RGB only)	E-38
Auto Start	E-38
Power Management	E-38
Power Off Confirmation	E-38
Keystone Save	E-38
Clear Lamp Hour Meter	E-38
Communication Speed	E-38
Default Source Select	E-38

Tools	E-39
Capture	E-39
PC Card Files	E-39
Changing Background Logo	E-40
Chalk Board	E-40

Help	E-40
Contents	E-40
Information	E-40

Using the PC Card Viewer Function	E-41
Features	E-41
Inserting and Ejecting a CompactFlash™ Card	E-41
Installing the PC Card Viewer Software	E-42
Starting Up the PC Card Viewer Software on your PC (PC Card Viewer Utility 1.0)	E-42
Operating the PC Card Viewer Function from the Projector (playback)	E-43
Capturing Images Displayed on the Projector	E-45
Viewing Digital Images	E-45
Uninstalling the PC Card Viewer Software	E-46
Terminology	E-47

4. MAINTENANCE

Replacing the Lamp	E-48
Cleaning or Replacing the Filters	E-49

5. TROUBLESHOOTING

Power / Status Light Messages	E-50
Common Problems & Solutions	E-50

6. SPECIFICATIONS

Optical/Electrical/Mechanical	E-52
Cabinet Dimensions	E-53
D-Sub Pin Assignments	E-54
Timing Chart	E-55
PC Control Codes	E-56
Cable Connection	E-56

CompactFlash is trademark of San Disk Corporation.

1. INTRODUCTION

Introduction to the MultiSync LT156/LT155/LT154 Projector

This section introduces you to your new MultiSync LT156 (XGA) / LT155 (XGA) / LT154 (XGA) Projector and describes the features and controls.

Congratulations on Your Purchase of The MultiSync LT156/LT155/LT154 Projector

The MultiSync LT156/LT155/LT154 is one of the very best projectors available today. The MultiSync LT156/LT155/LT154 enables you to project precise images up to 300 inches across (measured diagonally) from your PC or Macintosh computer (desktop or notebook), VCR, DVD player, document camera, a laser disc player or PC Card Viewer.

You can use the projector on a tabletop or cart, you can use the projector to project images from behind the screen, and the projector can be permanently mounted on a ceiling*¹. The remote control can be used wirelessly.

Features you'll enjoy:

- Simple set up and operation.
- A high-performance 130 watt NSH lamp.
- The supplied wireless remote control operates the projector from the front side or rear.
- The image can be projected between 25 and 300 inches (measured diagonally).
- Keystone correction allows you to correct trapezoidal distortion so that the image is square.
- You can choose between video modes depending on your source: "normal" for a typical picture, "natural" for true color reproduction.
- The built-in PC Card Viewer allows you to start your presentation even when a PC is not available at the site.
- The "Capture" enables you to capture the current projected image.
- An image can be projected from in front or behind a screen, and the projector can even be installed on the ceiling.
- NEC Technologies' exclusive Advanced AccuBlend intelligent pixel blending technology - an extremely accurate image compression technology - offers a crisp image with UXGA (1600×1200) resolution*².
- Supports most IBM VGA, SVGA, XGA, SXGA/UXGA(with Advanced AccuBlend)*², Macintosh, component signal (YCbCr / YPbPr) or any other RGB signals within a horizontal frequency range of 15 to 100 kHz and a vertical frequency range of 50 to 120 Hz. This includes NTSC, PAL, PAL-N*³, PAL-M*³, PAL60, SECAM and NTSC4.43 standard video signals.

NOTE: Composite video standards are as follows:

NTSC: U.S. TV standard for video in U.S. and Canada.

PAL: TV standard used in Western Europe.

PAL-N: TV standard used in Argentine, Paraguay and Uruguay.

PAL-M: TV standard used in Brazil.

PAL60: TV standard used for NTSC playback on PAL TVs.

SECAM: TV standard used in France and Eastern Europe.

NTSC4.43: TV standard used in Middle East countries.

- The supplied remote control can be used without a cable, and you can even use the remote control and mouse adapter to operate your PC or Macintosh mouse wirelessly from across the room with the built-in remote mouse receiver.
- You can control the projector with a PC using the PC Control port*⁴.
- USB terminal allows USB mouse operation *⁵.
- The contemporary cabinet design is light, compact, easy to carry, and complements any office, boardroom or auditorium.
- Eight pointers are available for your presentation.

*¹ Do not attempt to mount the projector on a ceiling yourself.

The projector must be installed by qualified technicians in order to ensure proper operation and reduce the risk of bodily injury. In addition, the ceiling must be strong enough to support the projector and the installation must be in accordance with any local building codes. Please consult your dealer for more information.

*² A UXGA (1600×1200) and an SXGA (1280×1024) image are displayed with NEC technology's Advanced AccuBlend. This applies only to analog RGB signal.

*³ LT156 only.

*⁴ The PC Control Utility 1.0 is required. This program is included on the supplied CD-ROM.

*⁵ The USB terminal meets the USB1.1 specification and accepts a USB mouse only.

Getting Started

The fastest way to get started is to take your time and do everything right the first time. Take a few minutes now to review the user's manual. This may save you time later on. At the beginning of each section of the manual you'll find an overview. If the section doesn't apply, you can skip it.

What's in the Box?

Make sure your box contains everything listed. If any pieces are missing, contact your dealer.
Please save the original box and packing materials if you ever need to ship your MultiSync LT156/LT155/LT154 Projector.

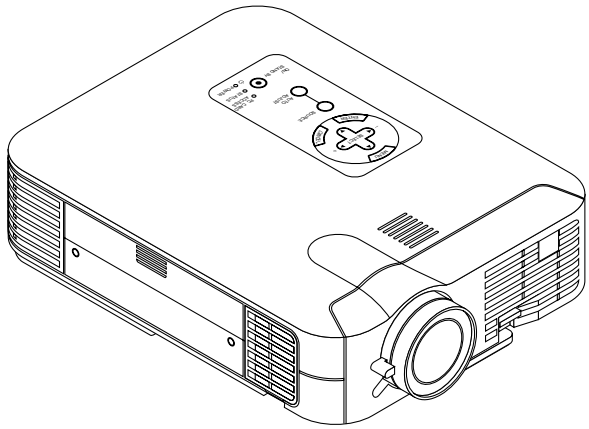

NEC MultiSync LT156/LT155/LT154 projector

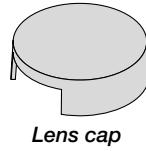

Lens cap

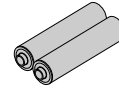

Batteries (AA × 2)

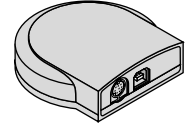

Remote mouse receiver



String and rivet

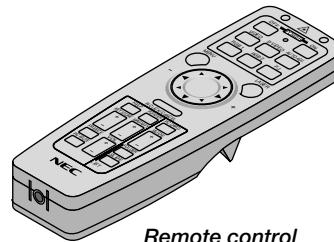

Remote control

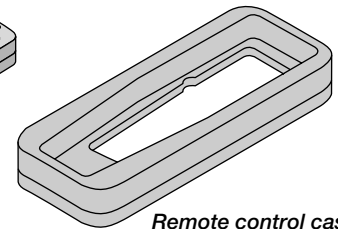

Remote control case

LT156 only

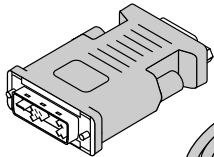

DVI-A – VGA adapter

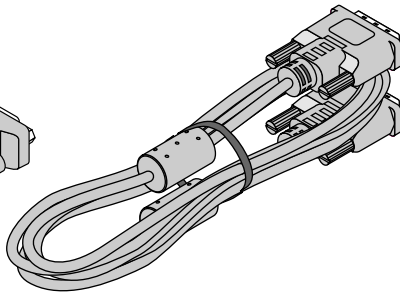

DVI-D – DVI-D signal cable

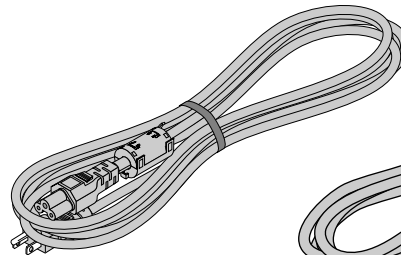

Power cable

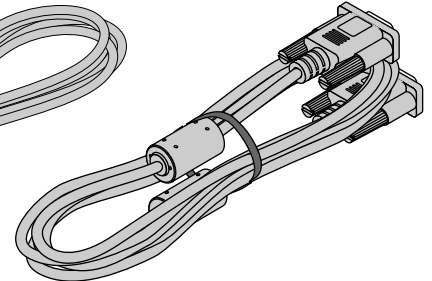

RGB signal cable

(15-Pin Mini D-Sub To 15-Pin Mini D-Sub connector)

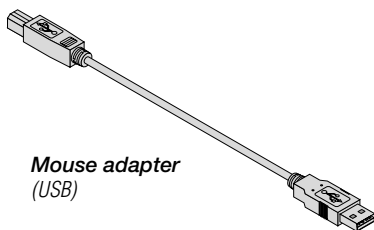

Mouse adapter (USB)

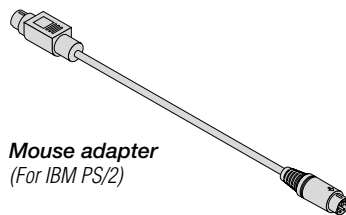

Mouse adapter (For IBM PS/2)

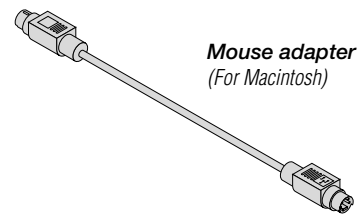

Mouse adapter (For Macintosh)

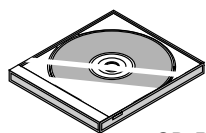

CD-ROM

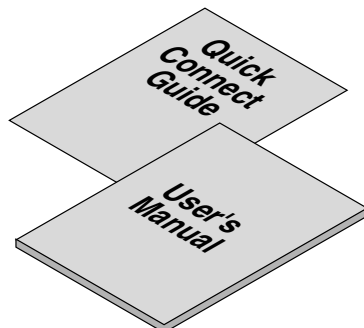

Soft carrying case

Getting to Know Your MultiSync LT156/LT155/LT154 Projector

Front/Side Features

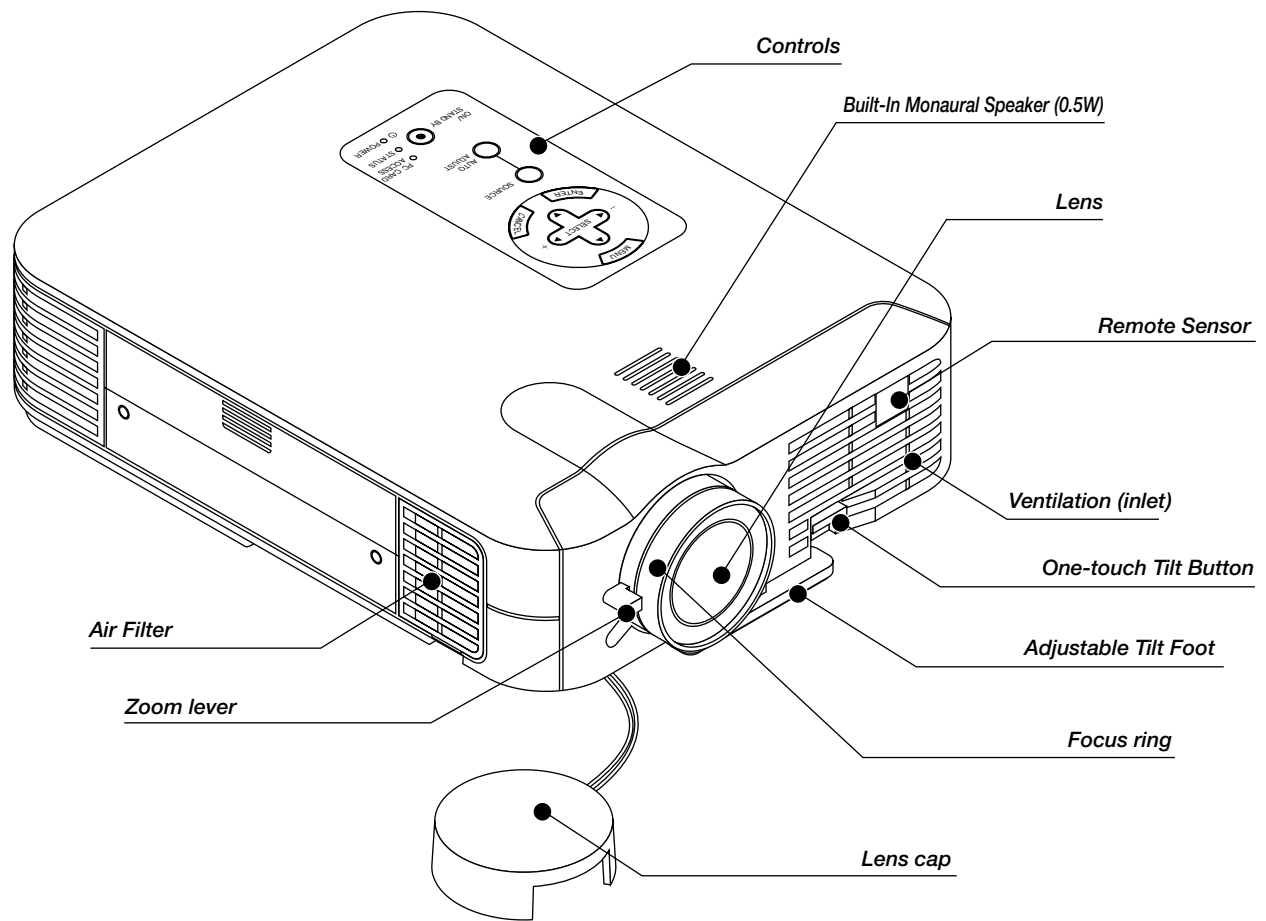

Attaching the lens cap to the lens hood with the supplied string and rivet

1. Thread the string through the hole on the lens cap and then tie a knot in the string.
2. Use the rivet to attach the string to the bottom of the lens hood.

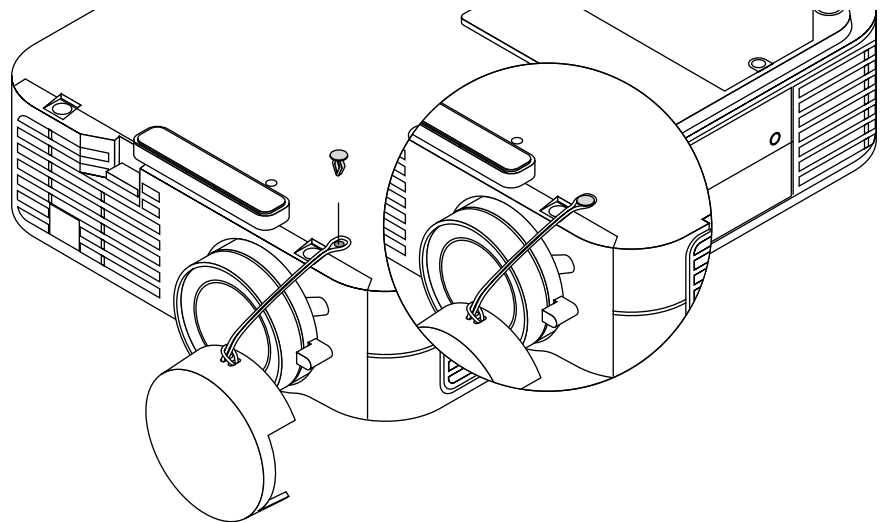
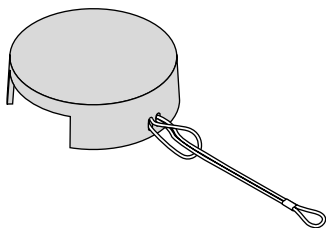

Rear/Side Features

AC Input

Connect the supplied power cable's three-pin plug here.

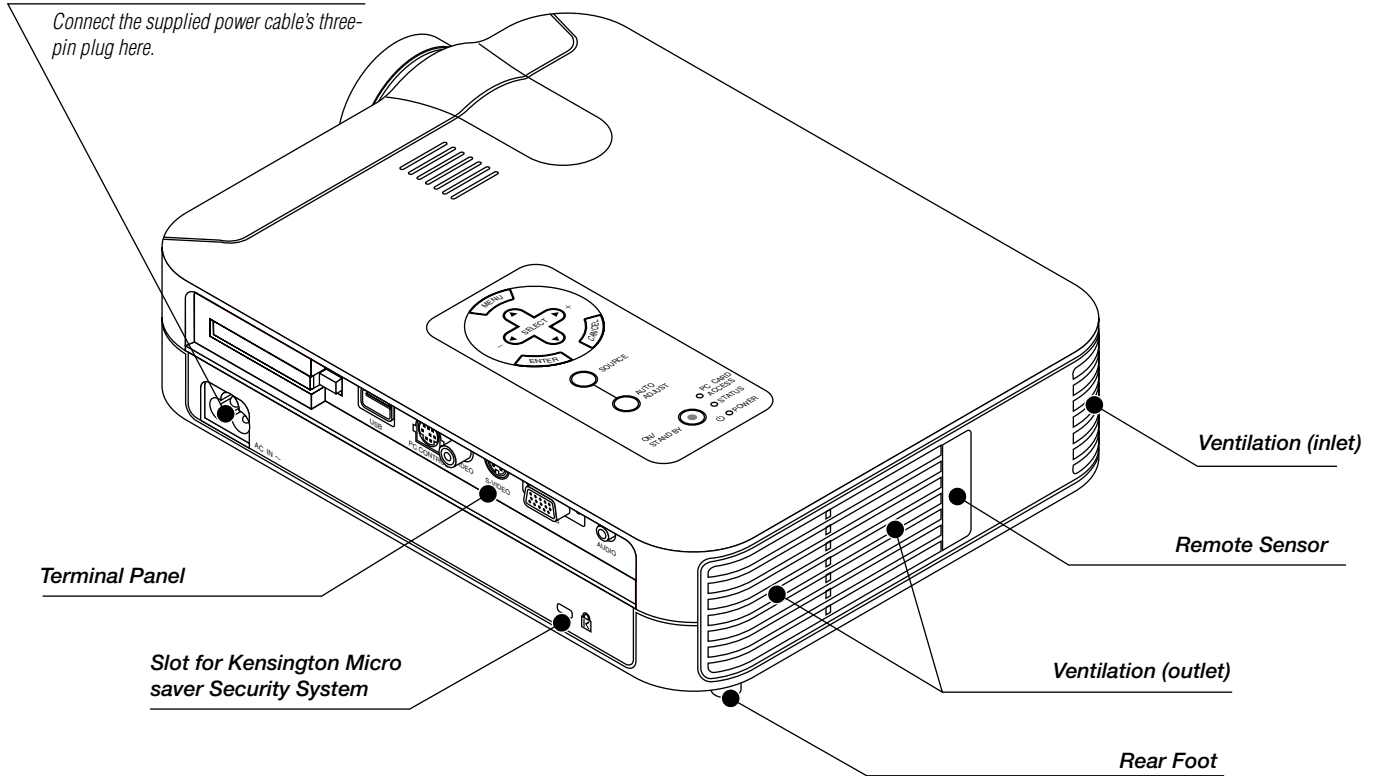

Bottom

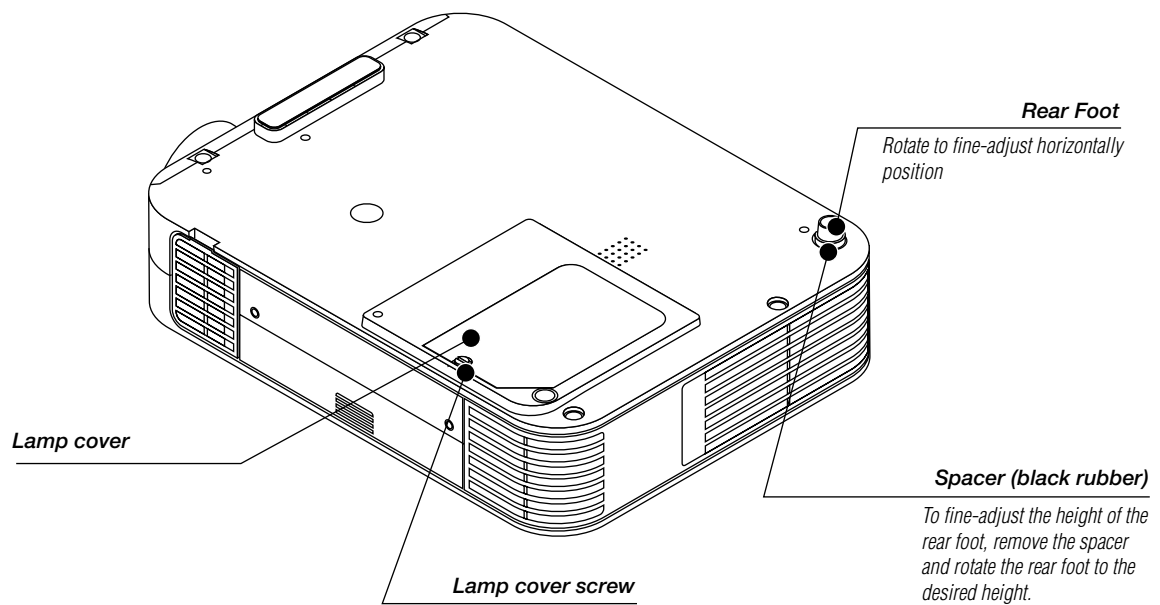

Top Features

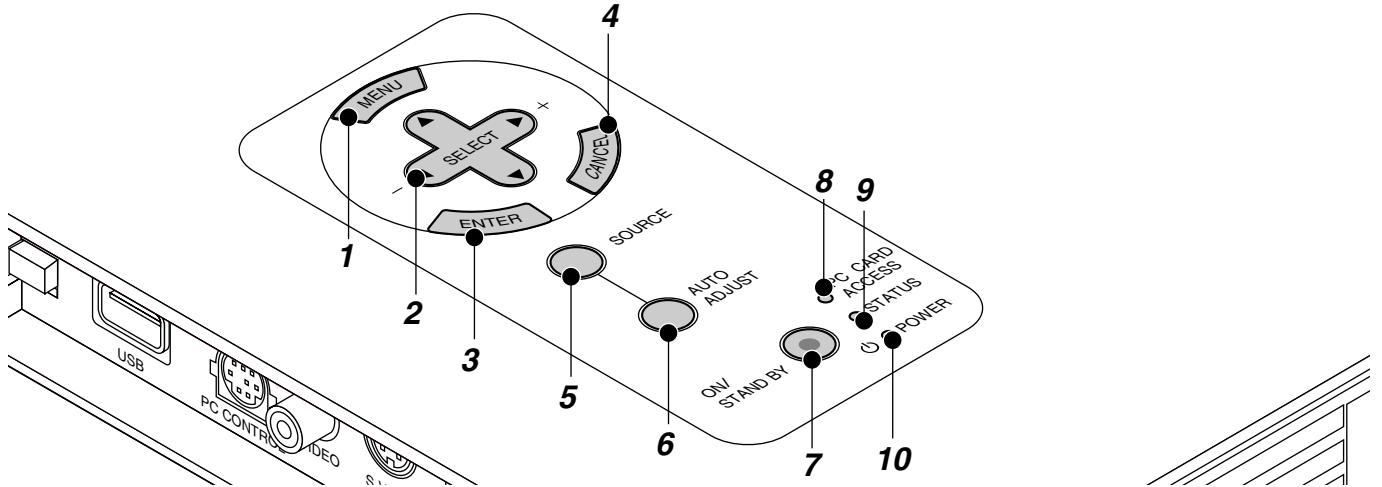

1. Menu Button

Displays the menu.

2. Select ▲▼ ◀▶ / Volume (+) (-) Buttons

▲▼: Use these buttons to select the menu of the item you wish to adjust.

When no menus appear, these buttons work as a volume control.

◀▶: Use these buttons to change the level of a selected menu item. A press of the ▶ button executes the selection.

When the menus or the Viewer tool bar is not displayed, these buttons can be used to select a slide, or to move the cursor in Folder List or Slide List.

When the pointer is displayed, these ▲▼ ◀▶ buttons move the pointer.

3. Enter Button

Executes your menu selection and activates items selected from the menu.

4. Cancel Button

Press this button to exit "Menus". Press this button to return the adjustments to the last condition while you are in the adjustment or setting menu.

5. Source Button

Use this button to select a video source such as a PC, VCR, DVD player or PC Card Viewer (CompactFlash card).

Each time this button is pressed, the input source will change as follows:

→ RGB ["DVI (DIGITAL) → DVI (ANALOG)" on LT156] → Video
 PC Card Viewer ← S-Video ←

If no input signal is present, the input will be skipped.

6. Auto Adjust Button (RGB only)

Use this button to adjust Position-H/V and Pixel Clock/Phase for an optimal picture. Some signals may not be displayed correctly or take time to switch between sources.

7. Power Button (ON / STAND BY)

Use this button to turn the power on and off when the power is supplied and the projector is in standby mode.

NOTE: To turn off the projector, press and hold this button for a minimum of two seconds.

8. PC Card Access Indicator

Lights while accessing a CompactFlash memory card.

9. Status Indicator

When this is lit red (orange in Eco mode) continually, it's warning you that the projection lamp has exceeded 1000 hours (2000 hours in Eco mode) of service. After this light appears, it is advisable to replace the projection lamp as soon as possible. (See page E-48). In addition the message "The lamp has reached the end of its usable life. Please replace the lamp." appears continually until the lamp is replaced.

If this light blinks red rapidly, it indicates that the lamp cover is not attached properly or the projector is overheated.

See the Power / Status Light Messages on page E-50 for more details.

10. Power Indicator ()

When this indicator is green, the projector is on; when the indicator is orange, it is in standby mode.

Terminal Panel Features

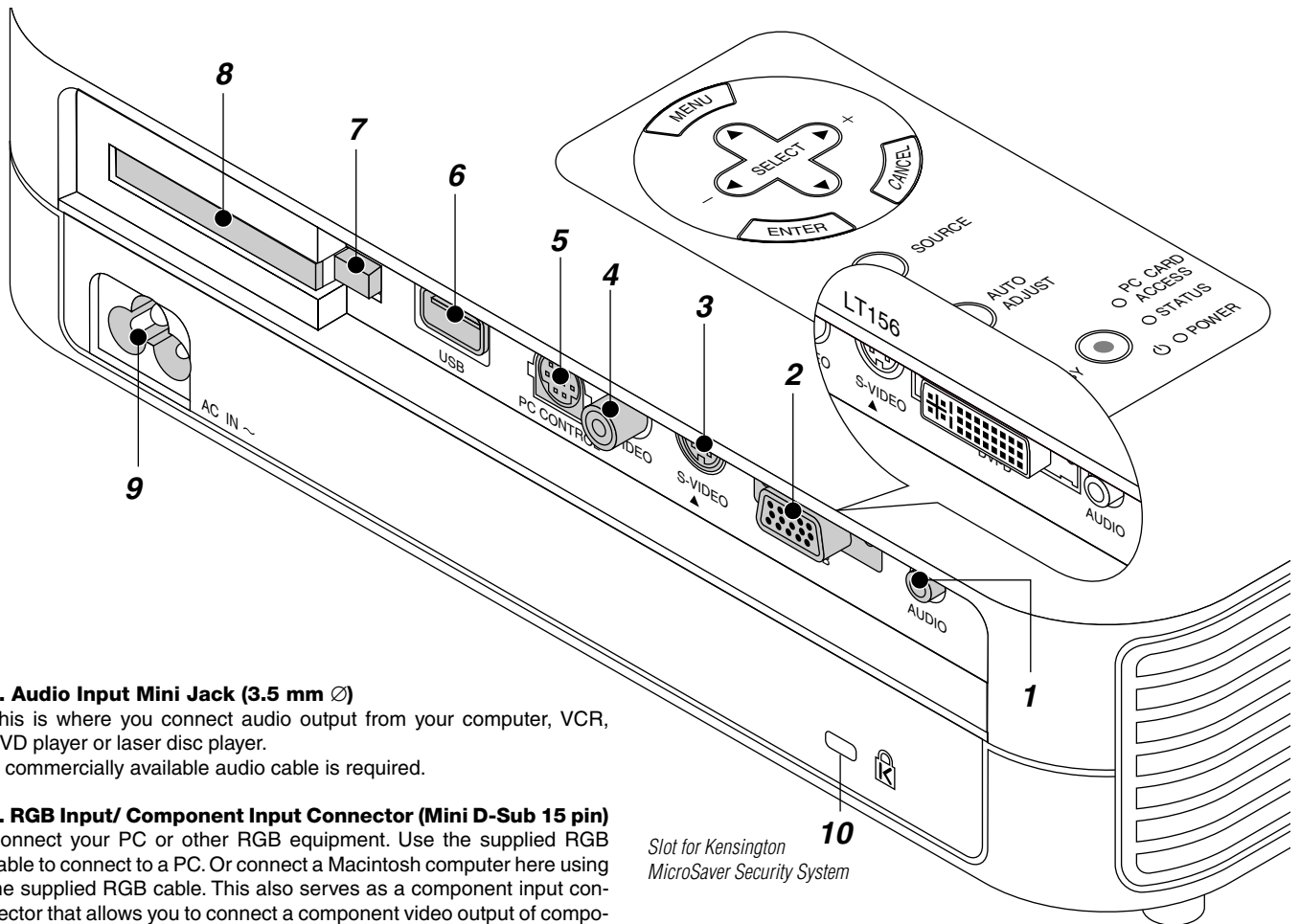

1. Audio Input Mini Jack (3.5 mm Ø)

This is where you connect audio output from your computer, VCR, DVD player or laser disc player.

A commercially available audio cable is required.

2. RGB Input/ Component Input Connector (Mini D-Sub 15 pin)

Connect your PC or other RGB equipment. Use the supplied RGB cable to connect to a PC. Or connect a Macintosh computer here using the supplied RGB cable. This also serves as a component input connector that allows you to connect a component video output of component equipment such as a DVD player.

For LT156: DVI Connector (DVI 29-pin)

This connector can accept digital or analog signal input from a computer with a DVI connector.

If you connect a mini D-sub 15 pin connector of a computer, attach the supplied DVI-A–VGA adapter to this connector.

3. S-Video Input (Mini DIN 4 Pin)

Here is where you connect the S-Video input from an external source like a VCR.

NOTE: S-Video provides more vivid color and higher resolution than the traditional composite video format.

4. Video Input (RCA)

Connect a VCR, DVD player, laser disc player, or document camera here to project video.

5. PC Control Port (Mini DIN 8 Pin)

Use this port to connect your PC to control your projector via a serial cable. This enables you to use your PC and serial communication protocol to control the projector. The NEC optional serial cable is required to use this port. Also PC Control Utility 1.0 included in the supplied CD-ROM must be installed on your PC.

If you are writing your own program, typical PC control codes are on page E-56.

A cap is put on the port at the factory. Remove the cap when using the port.

Slot for Kensington
MicroSaver Security System

6 USB Terminal

Connect a commercially available mouse that supports USB. You can operate the menu or PC Card Viewer with the USB mouse via this terminal.

Note that this terminal is not used with a computer and that there may be some brands of USB mouse that the projector does not support.

7. PC Card Eject Button

Press to eject a CompactFlash memory card.

8. PC Card Slot

Insert a CompactFlash memory card here.

9. AC Input

Connect the supplied power cable's three-pin plug here. When you plug the other end into an active wall outlet, the POWER indicator turns orange and the projector is in standby mode.

10 Built-in Security Slot ()

This security slot supports the MicroSaver® Security System. MicroSaver® is a registered trademark of Kensington Microware Inc. The logo is trademarked and owned by Kensington Microware Inc.

Remote Control Features

NOTE: If you are using a Macintosh computer, you can click either the right-click or left-click button to activate the mouse.

NOTE: If any one of the buttons is pressed and held for 60 seconds or more, the button operations will cease to operate. This is not a malfunction, rather it is a feature used to prolong battery power. To cancel this feature, press any one of the buttons other than the Mouse button.

1. Infrared Transmitter

Direct the remote control toward the remote sensor on the projector cabinet.

2. Laser Pointer

Beams a laser light when "Laser" button is pressed.

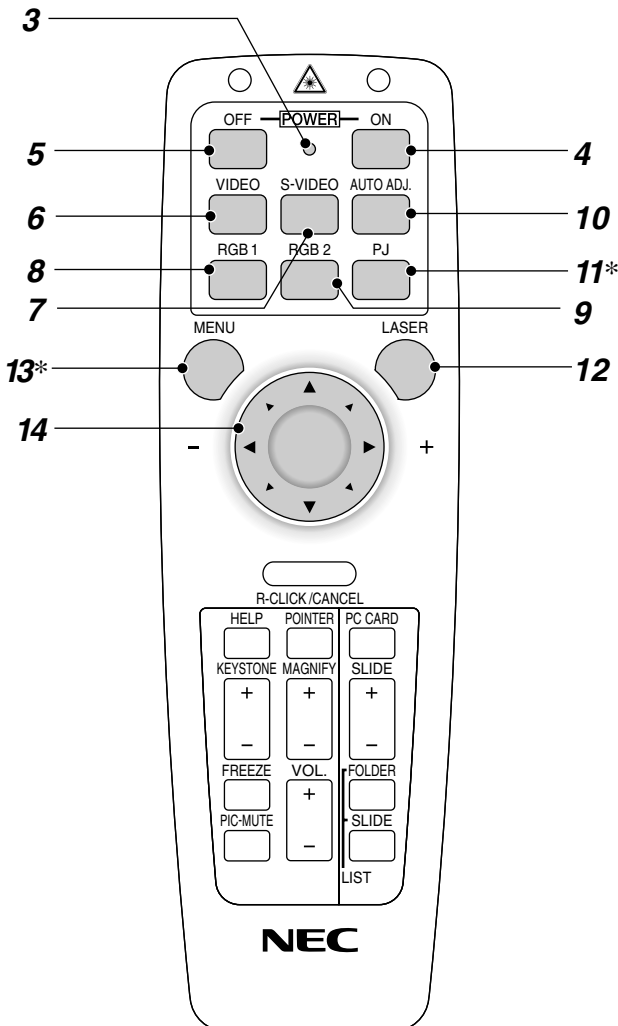
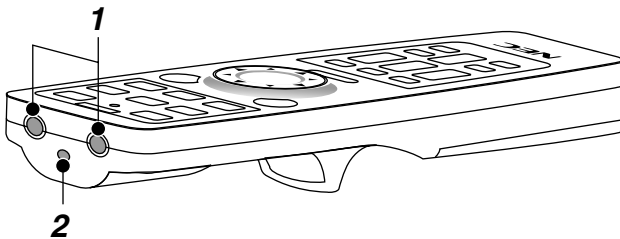

3. LED

Flashes when any button is pressed.

4. Power On Button

If the main power is applied, you can use this button to turn your projector on.

5. Power Off Button

If the main power is applied, you can use this button to turn your projector off.

NOTE: To turn off the projector, press and hold the POWER OFF button for a minimum of two seconds.

6. Video Button

Press this button to select an NTSC, PAL, SECAM or NTSC4.43 compatible video source from a VCR, DVD player, laser disc player or document camera.

7. S-Video Button

Press this button to select an S-Video source from a VCR.

8. RGB 1 Button

Press this button to select a video source from computer or component equipment connected to your RGB port (DVI digital on LT156).

9. RGB 2 Button

Not available on LT155/LT154.

For LT156:

Press this button to select DVI analog signal from a computer.

10. Auto Adjust Button (RGB only)

Press this button to automatically adjust the vertical/horizontal position, clock frequency/phase and resolution if the projected picture is not centered, if there are vertical stripes on the picture or if the picture is flickering.

11. PJ Button

Press this button to switch the Mouse, Cancel/Right Click, and Enter/Left Click buttons between the Projector mode (lit red) and the Computer mode. Press this button or any one of the Menu, Help, Pointer, PC Card, Folder List or Slide List buttons to switch to the Projector mode and the PJ button lights red. To switch back to the Computer mode, press the PJ button again.

12. Laser Button

Press and hold this button to activate the laser pointer. When lit, you can use the laser to draw your audience's attention to a red dot that you can place on any object.

13. Menu Button

Displays the menu for various settings and adjustments.

14. Mouse (▲▼◀▶) / (+) (-) Button

When you are in the Computer mode, these buttons work as a computer mouse.

When you are in the Projector mode, which is indicated by lighting the PJ button:

▲▼: Use these buttons to select the menu of the item you wish to adjust.

◀▶: Use these buttons to change the level of a selected menu item. A press of the ▶ button executes the selection.

When the pointer is displayed, these ▲▼◀▶ buttons move the pointer.

15. Enter / Left Click Button

When you are in the Computer mode, this button works as the mouse left button.

When you are in the Projector mode, which is indicated by lighting the PJ button:

Use this button to enter your menu selection. It works the same way as the "Enter" button on the cabinet.

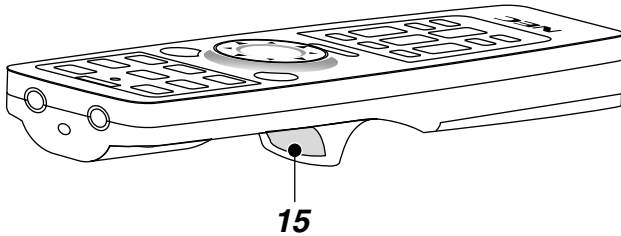

16. Cancel/ Right Click Button

When you are in the Computer mode, this button works as the mouse right button.

When you are in the Projector mode, which is indicated by lighting the PJ button:

Press this button to exit "Menus". It works the same way as the "Cancel" button on the cabinet.

17. Pointer Button

Press this button to display one of the eight pointers; press again to hide the pointer. You can move your pointer icon to the area you want on the screen using the Mouse button.

18. Help Button

Provides information about operation and adjustment procedures or the set information for the current menu or adjustment during menu operation.

19. Keystone (+) (-) Button

Press the (+) or (-) button to correct the keystone (trapezoidal) distortion, and make the image square.

20. Magnify (+) (-) Button

Use this button to adjust the image size up to 400%.

When the pointer is displayed, the image is magnified about the center of the pointer. When the pointer is not displayed, the image is magnified about the center of the screen.

When the image is magnified, the pointer is changed to the magnifying icon.

21. Freeze Button

This button will freeze a picture. Press again to resume motion.

22. Picture Mute Button

This button turns off the image and sound for a short period of time. Press again to restore the image and sound.

NOTE: When the menu is displayed, a press of this button mutes an image and sound without turning off the menu.

23. Volume (+) (-) Button

Press (+) to increase the volume and (-) to decrease it.

24. PC Card Button

Press this button to select the PC Card Viewer source.

25. Slide (+) (-) Button

Press (+) to select the next folder or slide and (-) to select the previous folder or slide.

26. Folder List Button

Press this button to select PC Card Viewer source to display a list of folders included in a CompactFlash memory card.

27. Slide List Button

Press this button to select PC Card Viewer source to display a list of slides included in a CompactFlash memory card.

28. Remote Jack

Not available on this model.

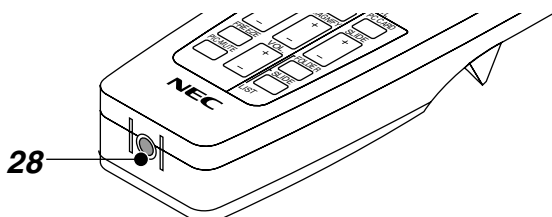
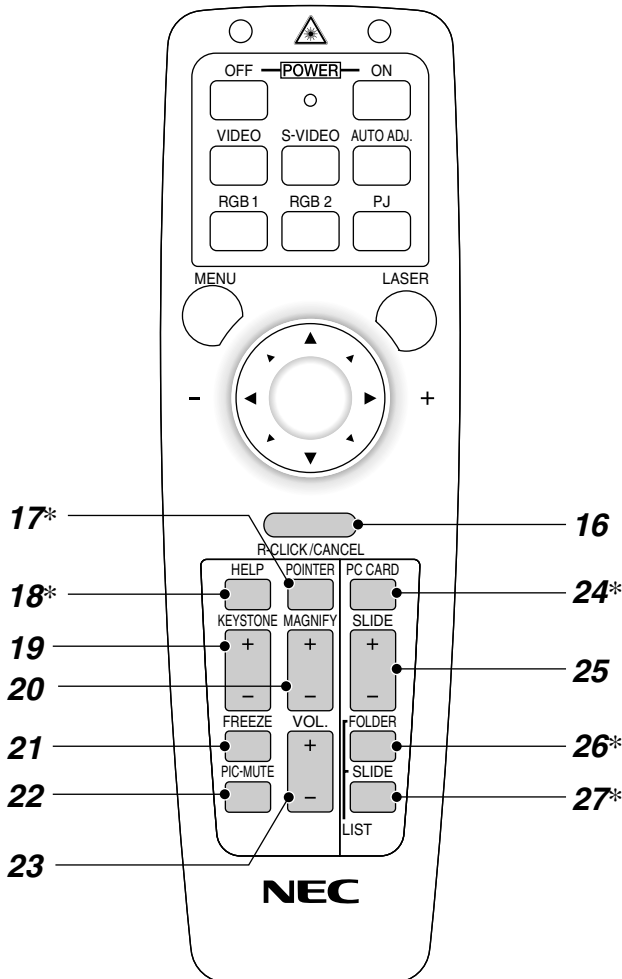

***NOTE:** The default is the Computer mode, which allows you to use the Mouse, R-Click/Cancel, and L-Click/Enter buttons as your computer mouse. When the MENU, HELP, POINTER, PC CARD, FOLDER LIST, or SLIDE LIST button is pressed, the PJ button lights red to indicate that you are in the Projector mode. If no buttons are pressed within 10 seconds, the light goes out and the Projector mode is canceled.

Remote Control Battery Installation

1. Press firmly and slide the battery cover off.

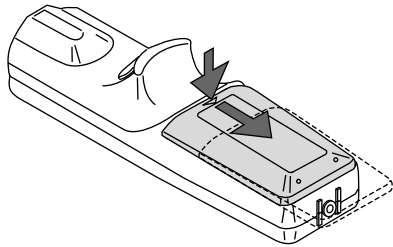

2. Remove both old batteries and install new ones (AA). Ensure that you have the batteries' polarity (+/-) aligned correctly.

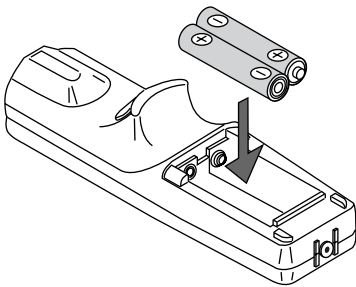

3. Slip the cover back over the batteries until it snaps into place.

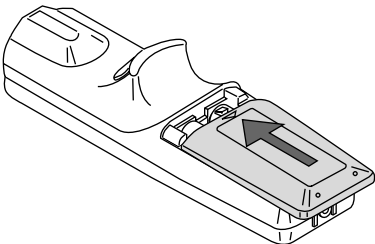

Do not mix different types of batteries or new and old batteries.

Operating Range

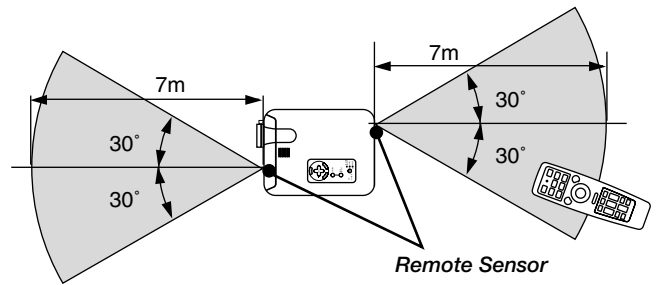

Remote Control Precautions

- Handle the remote control carefully.
- If the remote control gets wet, wipe it dry immediately.
- Avoid excessive heat and humidity.
- If you will not be using the remote control for a long time, remove the batteries.
- Do not place the batteries upside down.
- Do not look into the laser pointer while it is on.
- Do not point the laser beam at a person.

Using Remote Mouse Receiver

The remote mouse receiver enables you to operate your computer's mouse functions from the remote control (Computer mode). It is a great convenience for clicking through your computer-generated presentations. To return to the Projector mode, press the PJ button (lit red).

Connecting the remote mouse receiver to your computer

To use the remote mouse function, connect the remote mouse receiver to your computer with one of the remote mouse cables (USB, PS/2 or Mac ADB). Choose the appropriate mouse cable for your computer.

NOTE: Depending on the type of connection or OS installed on your computer, you may have to restart your computer or change your computer settings.

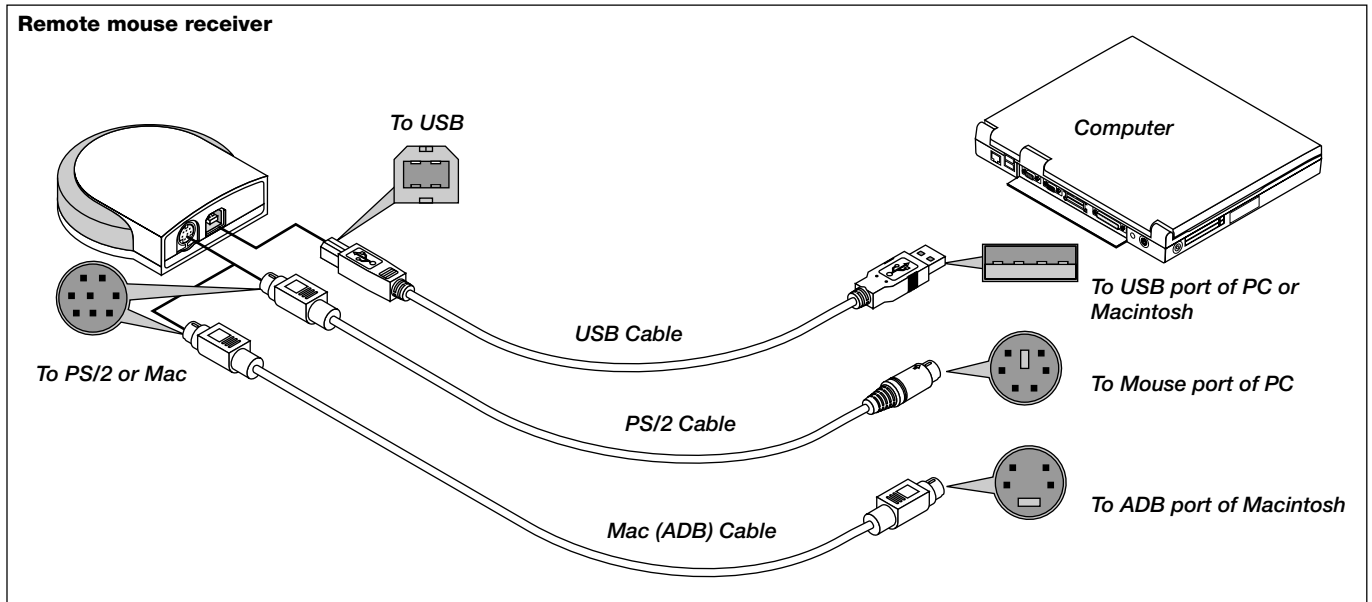

Notes on Connecting with USB Cable

- * When you use an IBM PC, the Remote mouse receiver does not support the other operating systems than Windows 98/2000.
- * Do not pull out the cable from the USB port of your PC or the remote mouse receiver and then immediately insert it back into the USB port. Allow a minimum of 5 seconds to elapse between insertion and extraction of the cable. Doing so repeatedly can result in your PC failing to detect the remote mouse receiver.
- * The supplied USB cable is designed especially for the Remote mouse receiver. If you use the USB cable with other equipment, we do not assure the correct functioning of the equipment.

When operating a computer via the remote mouse receiver

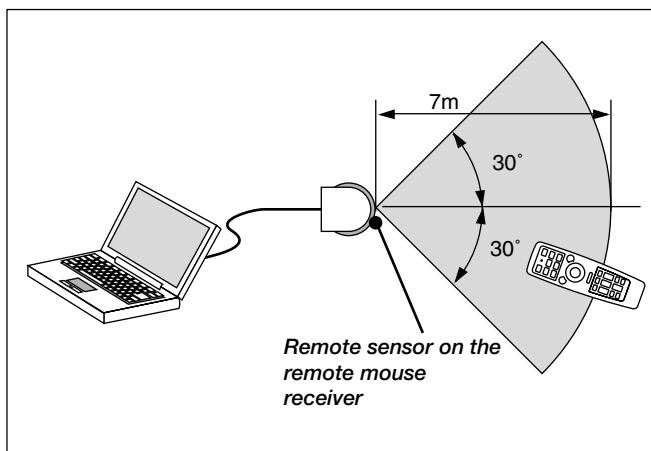

Switching operation mode between mouse and projector

The three shaded buttons shown on the drawing work as a computer mouse in the Computer mode. In the Computer mode the PJ button is not lit.

- When the MENU button is pressed, the PJ button lights red to indicate that you are in the Projector mode, which allows the projector menu operation using the three buttons.
- When the POINTER button is pressed, the PJ button lights red to indicate that you are in the Projector mode and that the MOUSE ▲▼◀▶ button works as a moving button for the POINTER or magnified image.
- If no buttons are pressed within 10 seconds, the PJ button's light goes out to indicate that you are in the Computer mode. To enable the projector menu operation again, press the PJ button to light red. To move the pointer or a magnified image again, turn off the pointer and then turn on the pointer (press the POINTER button two times).
- When the PJ button is lit, if you want to use the mouse function immediately, press the PJ button to return to the Computer mode (not lit).

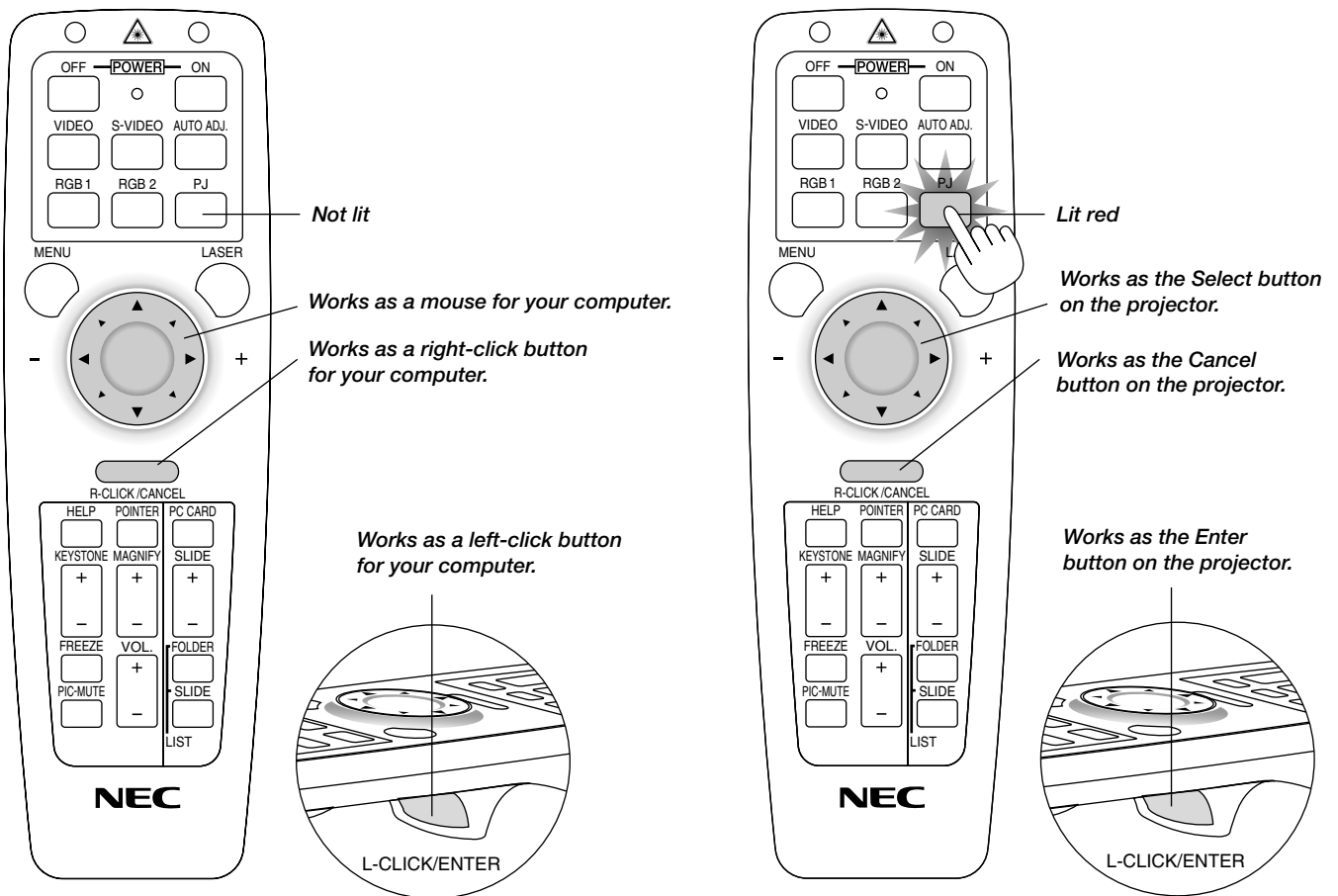

2. INSTALLATION

This section describes how to set up your MultiSync LT156/LT155/LT154 projector and how to connect video and audio sources.

Setting up Your Projector

Your MultiSync LT156/LT155/LT154 Projector is simple to set up and use. But before you get started, you must first:

1. Determine the image size.
2. Set up a screen or select a non-glossy white wall onto which you can project your image.
 Ensure that the power cable and any other cables connecting to video sources are disconnected before moving the projector.
 When moving the projector or when it is not in use, cover the lens with the lens cap.

Selecting a Location

The further your projector is from the screen or wall, the larger the image. The minimum size the image can be is approximately 25" (0.6 m) measured diagonally when the projector is roughly 3.7 feet (1.1 m) from the wall or screen. The largest the image can be is 300" (7.6 m) when the projector is about 40.1 feet (12.2 m) from the wall or screen.

Screen and Projection Distance

The following shows the proper relative positions of the projector and screen. Refer to the table to determine the position of installation.

Throw distance

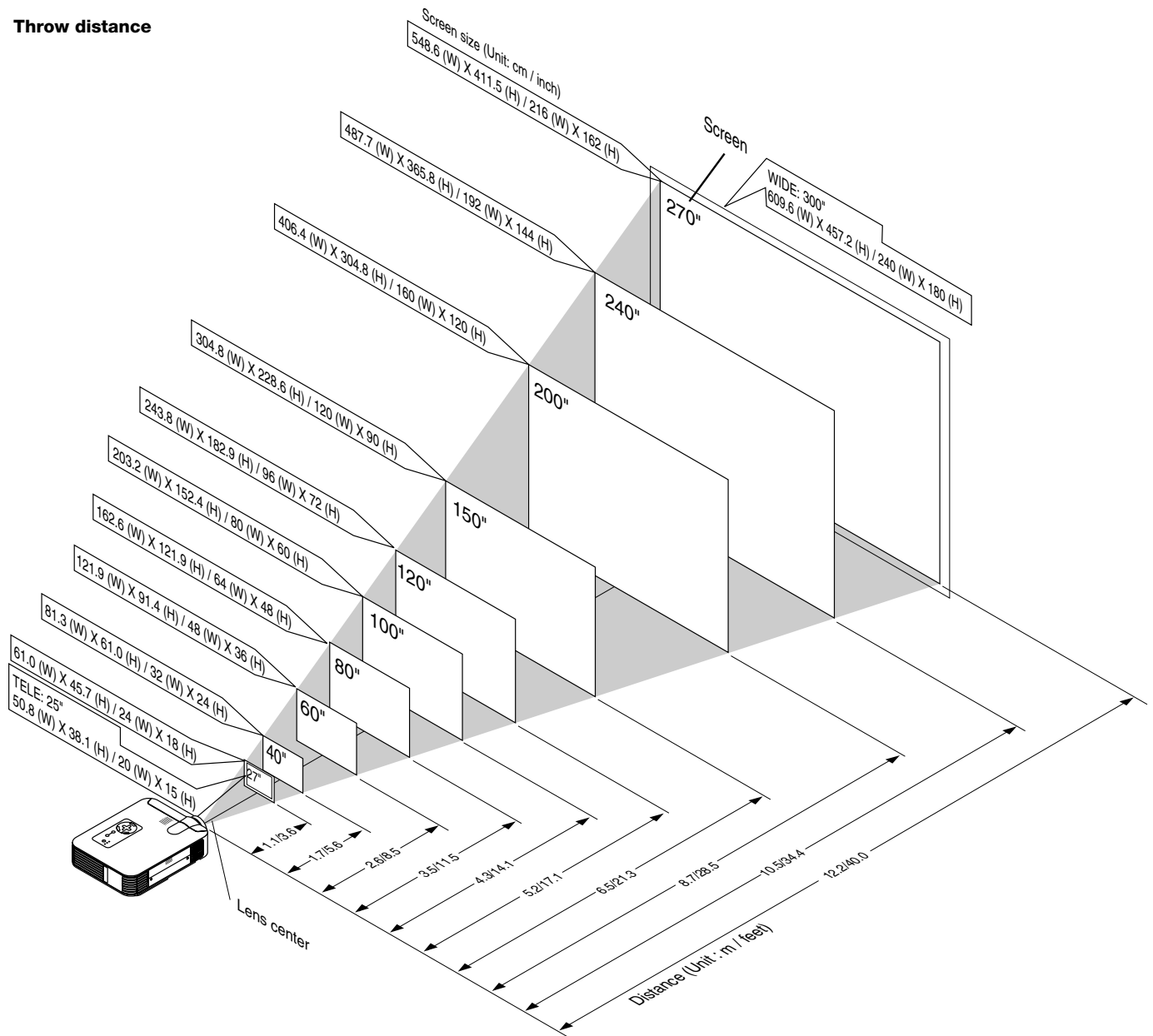

Distance Chart

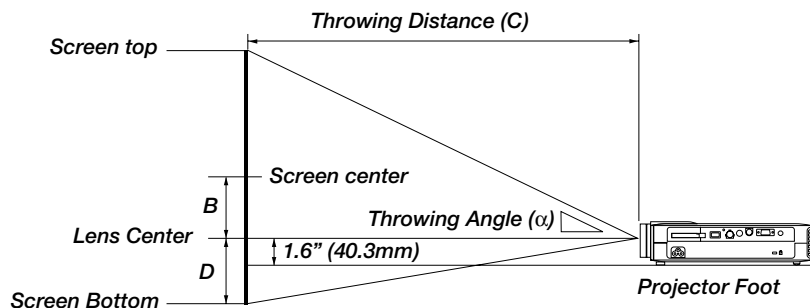

B=Vertical distance between lens center and screen center
 C=Throw distance
 D=Vertical distance between lens center and screen bottom (screen top for ceiling installation)

Ceiling Installation

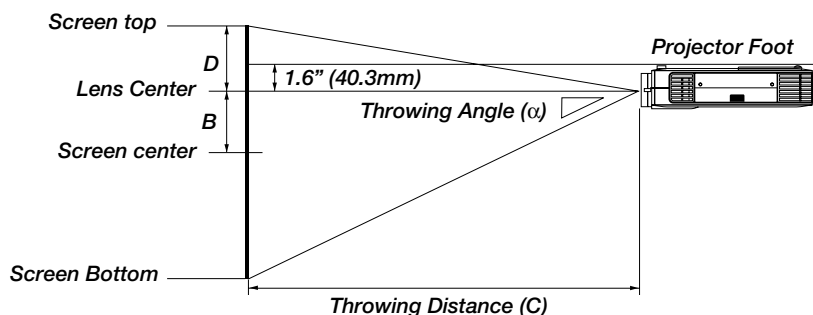

WARNING

- Installing your projector on the ceiling must be done by a qualified technician. Contact your NEC dealer for more information.
- * Do not attempt to install the projector yourself.
- Only use your projector on a solid, level surface. If the projector falls to the ground, you can be injured and the projector severely damaged.
- Do not use the projector where temperatures vary greatly. The projector must be used at temperatures between 32°F (0°C) and 95°F (35°C).
- Do not expose the projector to moisture, dust, or smoke. This will harm the screen image.
- Ensure that you have adequate ventilation around your projector so heat can dissipate. Do not cover the vents on the side or the front of the projector.

If your projector is mounted on the ceiling and your image is upside down, use the "Menu" and "Select" buttons on your projector cabinet or ▲▼ button on your remote control to correct the orientation. (See page E-37.)

Reflecting the Image

Using a mirror to reflect your projector's image enables you to enjoy a much larger image. Contact your NEC dealer if you need a mirror. If you're using a mirror and your image is inverted, use the "Menu" and "Select" buttons on your projector cabinet or ▲▼ buttons on your remote control to correct the orientation. (See page E-37.)

Screen Size						B		C				D		α			
Diagonal		Width		Height				wide		tele				wide		tele	
inch	mm	inch	mm	inch	mm	inch	mm	inch	mm	-	inch	mm	inch	mm	degree	-	degree
25	635	20	508	15	381	6	150	-	-	-	44	1110	-1	-40	-	-	7.8
30	762	24	610	18	457	7	180	46	1170	-	53	1350	-2	-50	8.9	-	7.8
40	1016	32	813	24	610	10	240	62	1580	-	72	1820	-2	-60	8.8	-	7.7
60	1524	48	1219	36	914	14	370	94	2400	-	109	2760	-4	-90	8.7	-	7.6
67	1702	54	1361	40	1021	16	410	106	2680	-	122	3090	-4	-100	8.7	-	7.6
72	1829	58	1463	43	1097	17	440	114	2890	-	131	3320	-4	-110	8.7	-	7.5
80	2032	64	1626	48	1219	19	490	127	3220	-	146	3700	-5	-120	8.6	-	7.5
84	2134	67	1707	50	1280	20	510	133	3380	-	153	3890	-5	-130	8.6	-	7.5
90	2286	72	1829	54	1372	22	550	143	3620	-	164	4170	-5	-140	8.6	-	7.5
100	2540	80	2032	60	1524	24	610	159	4030	-	183	4640	-6	-150	8.6	-	7.5
120	3048	96	2438	72	1829	29	730	191	4850	-	220	5580	-7	-180	8.6	-	7.5
150	3810	120	3048	90	2286	36	920	239	6080	-	275	6990	-9	-230	8.6	-	7.5
180	4572	144	3658	108	2743	43	1100	288	7300	-	331	8400	-11	-270	8.6	-	7.5
200	5080	160	4064	120	3048	48	1220	320	8120	-	368	9340	-12	-300	8.6	-	7.5
210	5334	168	4267	126	3200	51	1280	336	8530	-	386	9810	-12	-320	8.7	-	7.5
240	6096	192	4877	144	3658	58	1470	384	9760	-	442	11220	-14	-360	8.6	-	7.4
261	6629	209	5304	157	3978	63	1600	418	10610	-	481	12210	-16	-390	8.5	-	7.4
270	6858	216	5486	162	4115	65	1650	432	10980	-	-	-	-16	-410	8.5	-	-
300	7620	240	6096	180	4572	72	1830	481	12210	-	-	-	-18	-450	8.5	-	-

NOTE: Distances may vary +/-5%.

Wiring Diagram

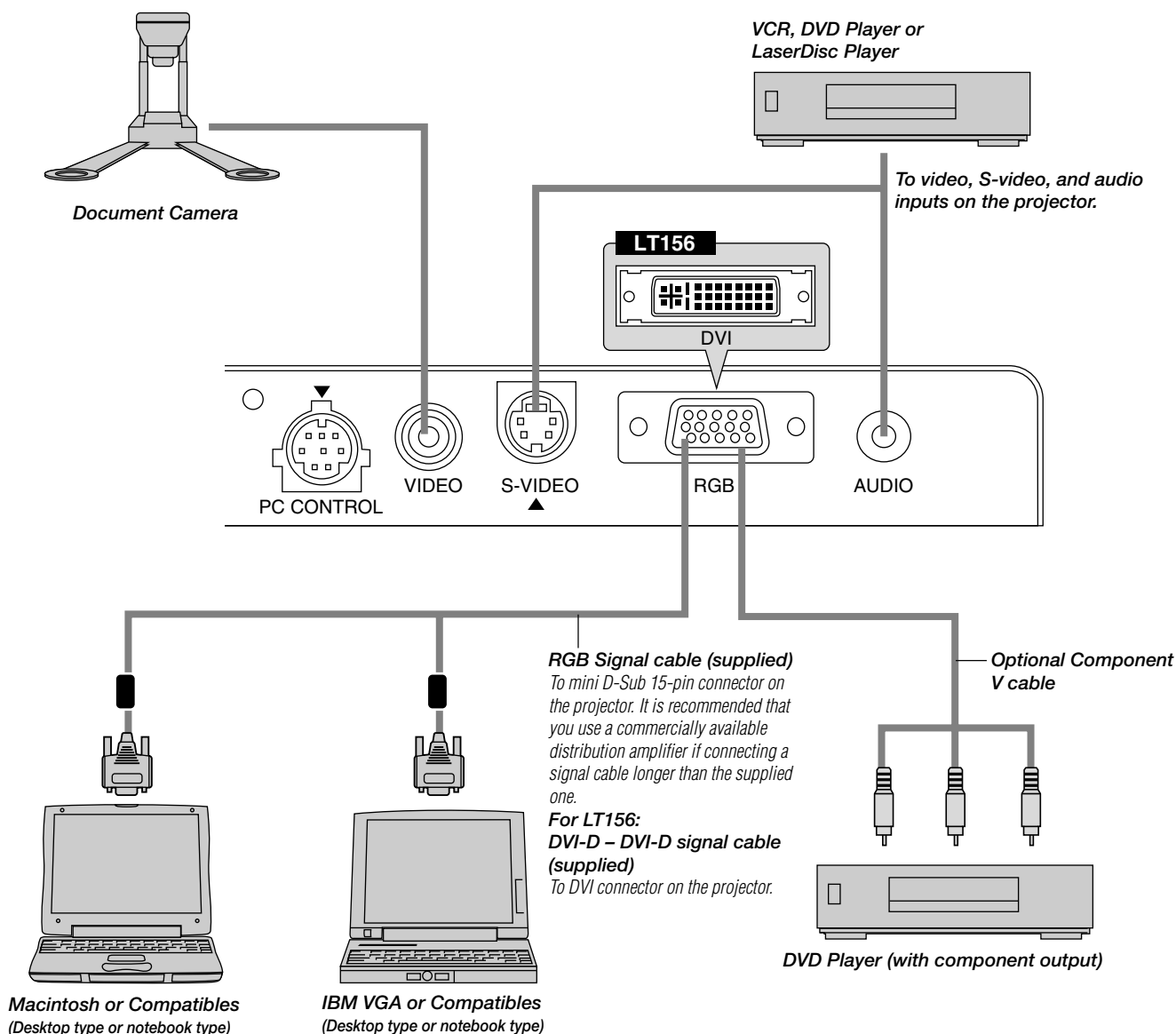

NOTE: When using with a notebook PC, be sure to connect between the projector and the notebook PC before turning on the power to the notebook PC. In most cases signal cannot be output from RGB output unless the notebook PC is turned on after connecting with the projector.

NOTE:

* If the screen goes blank while using your remote control, it may be the result of the computer's screen-saver or power management software.

* If you accidentally hit the POWER button on the remote control, wait 60 seconds and then press the POWER button again to resume.

NOTE: If using video, S-video, or audio cables, the cables should be 3 m (9.8 feet) or shorter.

For LT156:

NOTE: Some personal computers or video cards may not offer images correctly on LT156.

To connect a DVI connector on your computer to LT156, attach the supplied DVI-D – DVI-D signal cable to the DVI connector on the projector. If you use a separately sold DVI cable, images may not be correctly displayed.

NOTE: The DVI connector can accept a maximum resolution of 1024x768(XGA) when DVI (DIGITAL) input is selected.

Connecting Your PC

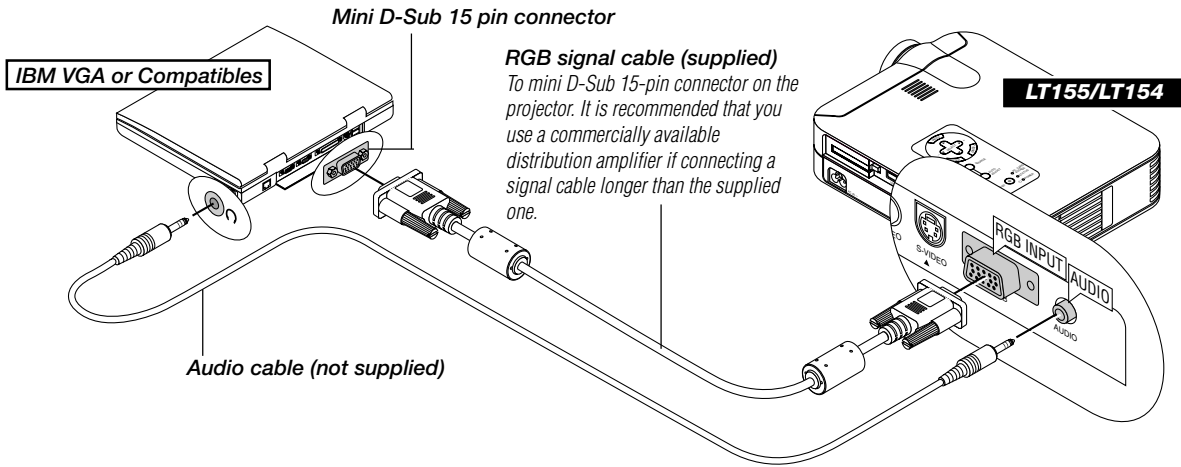

Connecting your PC to your MultiSync LT155 (XGA)/ LT154 (XGA) projector will enable you to project your computer's screen image for an impressive presentation.

To connect to a PC, simply:

1. Turn off the power to your projector and computer.
2. Use the supplied signal cable to connect your PC to the projector.
3. Turn on the projector and the computer.
4. If the projector goes blank after a period of inactivity, it may be caused by a screen saver installed on the computer you've connected to the projector.

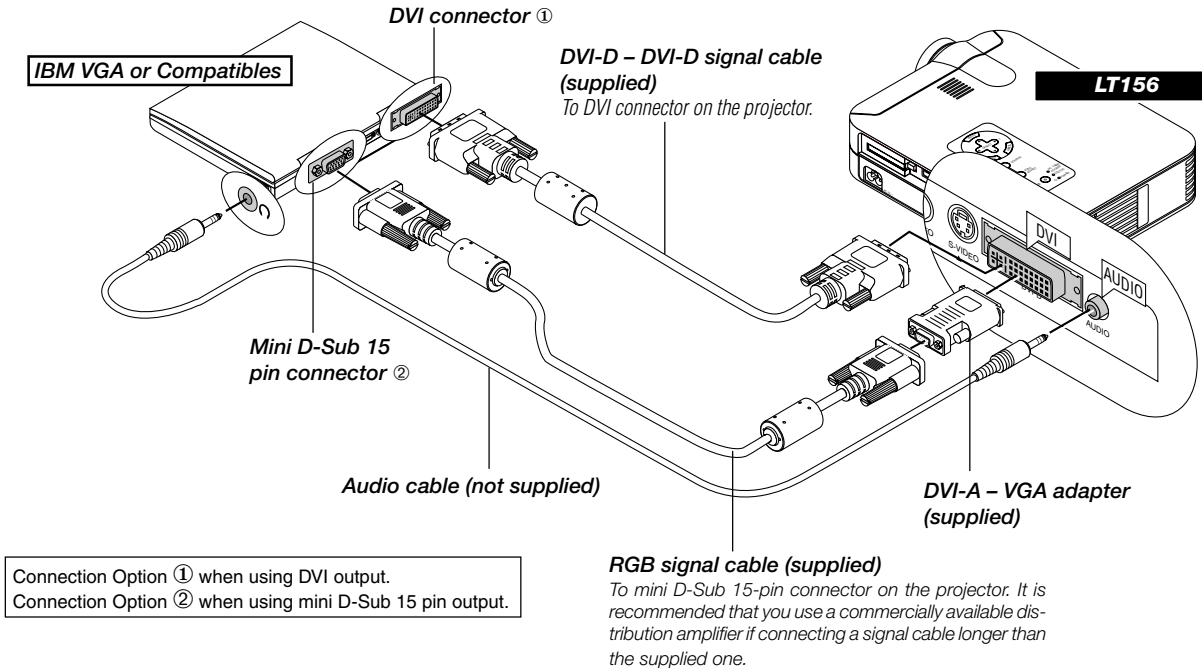

Connection Option ① when using DVI output.
Connection Option ② when using mini D-Sub 15 pin output.

Connecting Your PC with a DVI Connector

You can connect your PC with a DVI output to your MultiSync LT156 (XGA) projector.

When connecting a PC with a D-sub 15 pin analog connector, attach the supplied DVI-A – VGA adapter to the D-sub 15 pin connector of your PC.

To connect to a PC, simply:

1. Turn off the power to your projector and computer.
2. ① Use the supplied DVI-D--DVI-D signal cable to connect a DVI connector of your PC to the projector.
② To connect a PC with a mini D-sub 15 pin- mini D-sub 15 pin connector, attach the supplied DVI-A – VGA adapter to the DVI connector on the projector.
3. Turn on the projector and the computer.
4. If the projector goes blank after a period of inactivity, it may be caused by a screen saver installed on the computer you've connected to the projector.

Connecting Your Macintosh Computer

Macintosh (Notebook type)

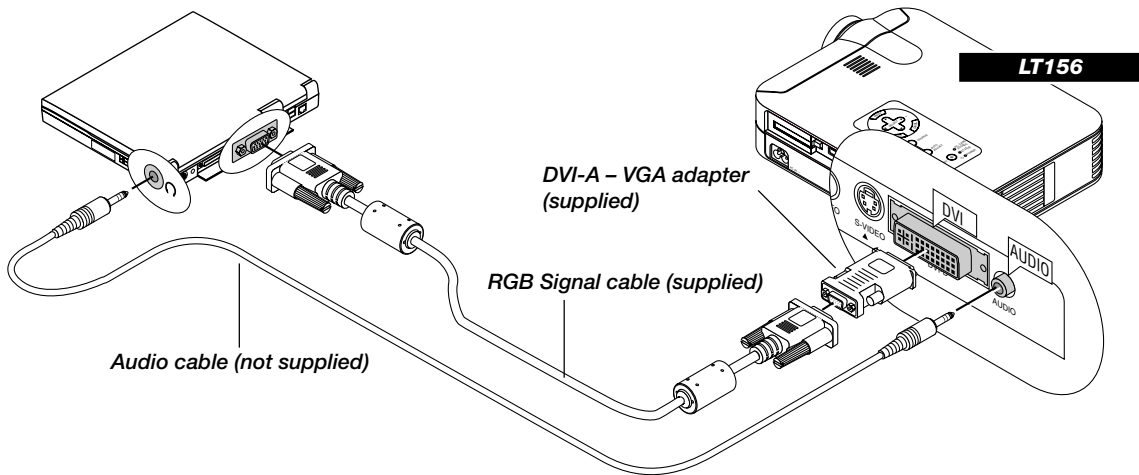
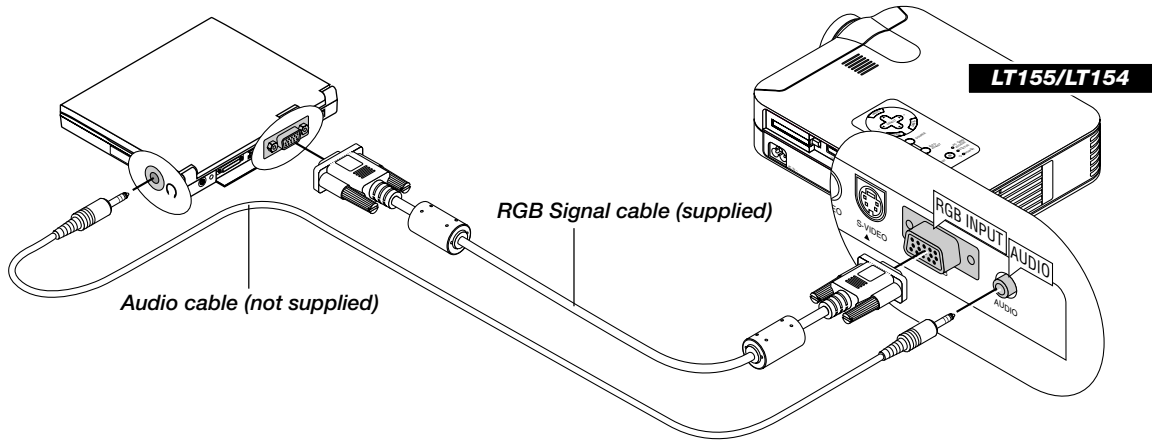

Macintosh (Desktop type)

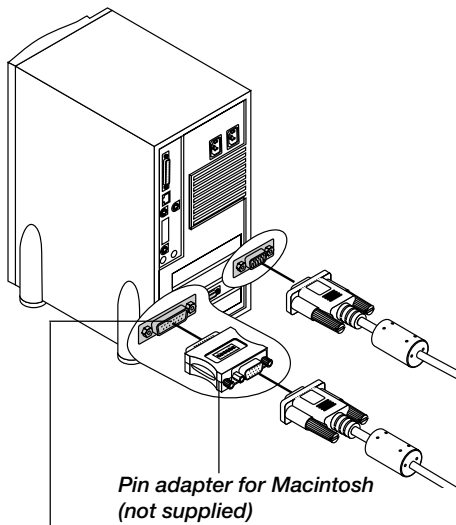

For older Macintosh, use a commercially available pin adapter to connect to your Mac's video port.

To connect to a Macintosh, simply:

1. Turn off the power to your projector and your Macintosh computer.
2. Use the supplied signal cable to connect your Macintosh computer to the projector.
3. Turn on the projector and the Macintosh computer.

For LT156:

When connecting a Macintosh with a mini D-sub 15 pin analog connector, attach the supplied DVI-A - VGA adapter to the DVI connector on the projector.

Connecting Your DVD Player

DVD player

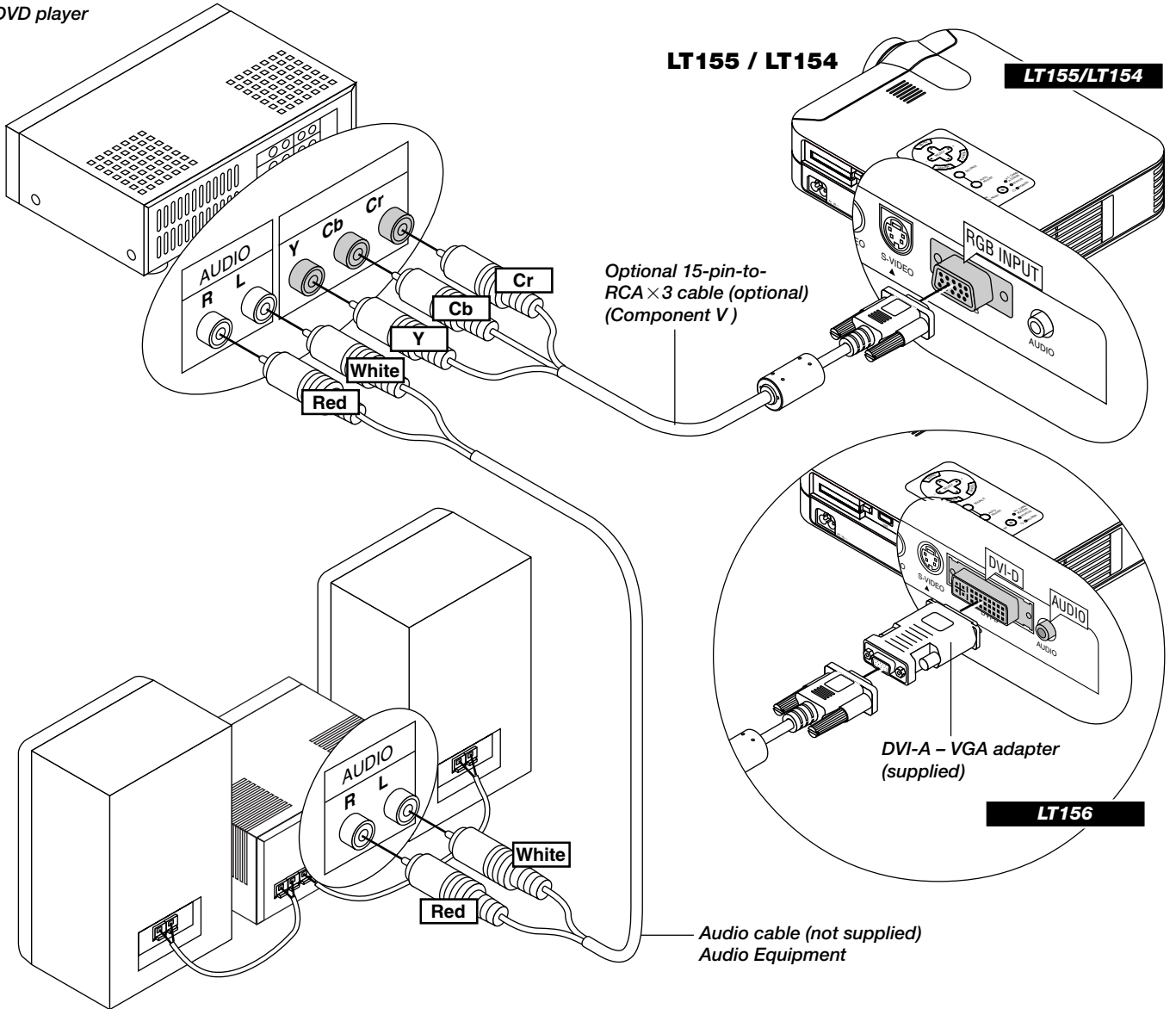

You can connect your projector to a DVD player with component outputs or Video output. To do so, simply:

1. Turn off the power to your projector and DVD player.
2. If your DVD player has the component video (Y,Cb,Cr) output, use the optional 15-pin-to-RCA × 3 cable to connect your DVD player to the RGB INPUT connector on the projector.
For a DVD player without component video (Y,Cb,Cr) outputs, use common RCA cables (not provided) to connect a composite VIDEO output of the DVD player to the Video Input of the projector.
3. Turn on the projector and DVD player.

NOTE: Refer to your DVD player's owner's manual for more information about your DVD player's video output requirements.

For LT156:
Attach the supplied DVI-A--VGA adapter to the DVI connector on your projector.

Connecting Your VCR or Laser Disc Player

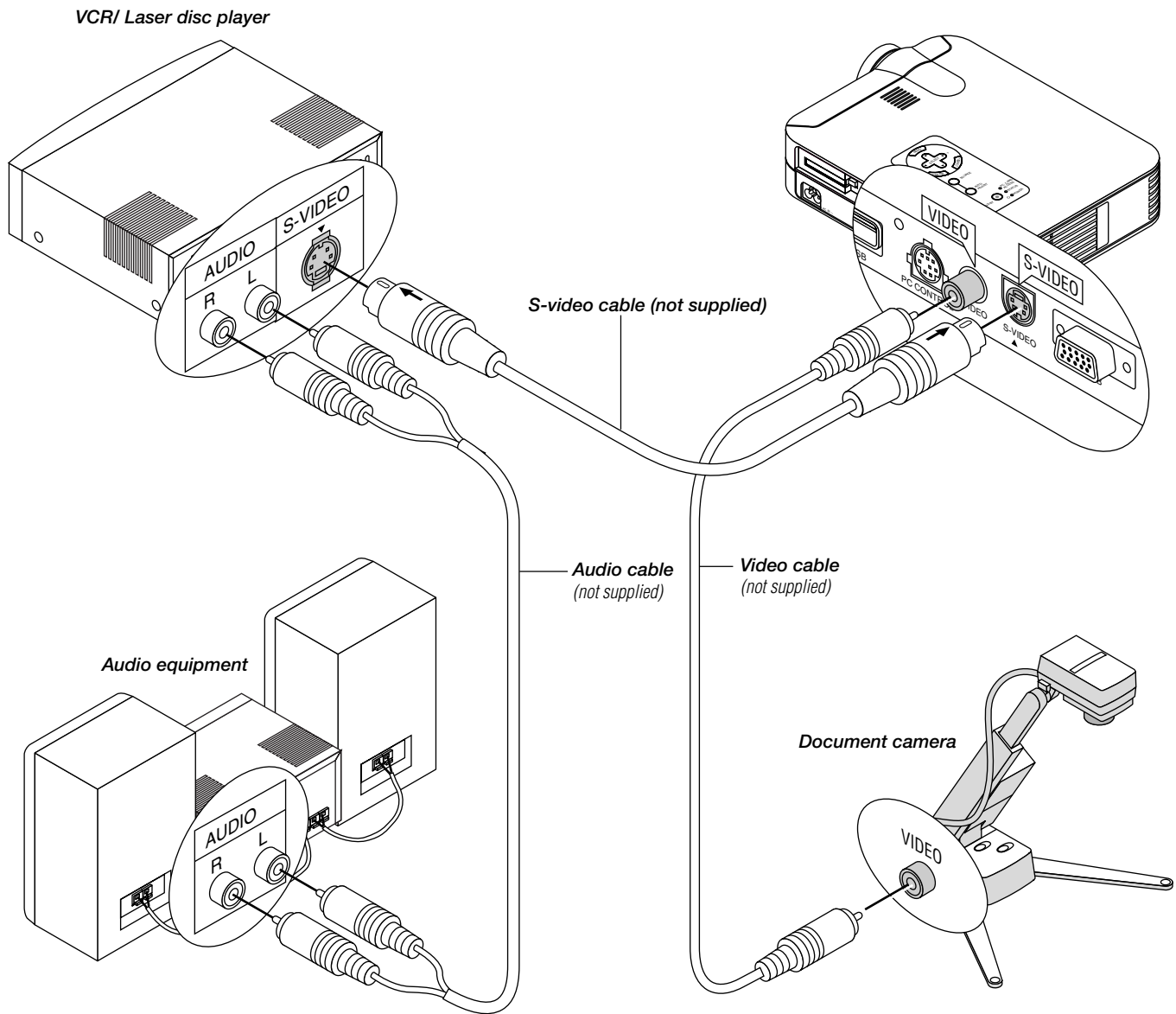

Use common RCA cables (not provided) to connect your VCR, laser disc player or document camera to your projector.

To make these connections, simply:

1. Turn off the power to the projector and VCR, laser disc player or document camera.
2. Connect one end of your RCA cable to the video output connector on the back of your VCR or laser disc player, connect the other end to the Video input on your projector. Use an audio cable (not supplied) to connect the audio from your VCR or laser disc player to your audio equipment (if your VCR or laser disc player has this capability). Be careful to keep your right and left channel connections correct for stereo sound.
3. Turn on the projector and the VCR or laser disc player.

NOTE: Refer to your VCR or laser disc player owner's manual for more information about your equipment's video output requirements.

About Startup screen (Menu Language Select screen)

When you first turn on the projector, you will get the Startup screen. This screen gives you the opportunity to select one of the seven menu languages: English, German, French, Italian, Spanish, Swedish and Japanese.

To select a menu language, follow these steps:

1. Use the Select ▲ or ▼ button to select one of the seven languages for the menu.



2. Press the Enter button to execute the selection.
3. The Basic/Custom menu will be displayed in the language you have selected.



To close the menu, press the Cancel button.

After this has been done, you can proceed to the advanced menu operation.

If you want, you can select the menu language later. See “Language” on page E-36.

3. OPERATION

Connecting the Power Cable and Turn on the Projector

Before you turn on your projector, ensure that the computer or video source is turned on and that your lens cap is removed.

1. Connect the supplied power cable to the projector.

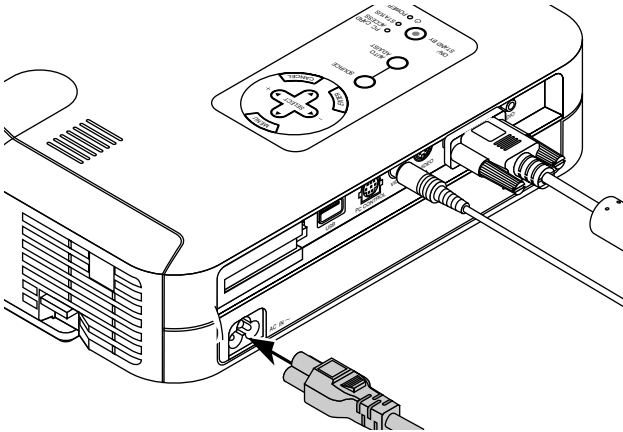

Plug the supplied power cable in the wall outlet. The projector will go into its standby mode and the power indicator will glow orange.

2. Turn on and off the Projector

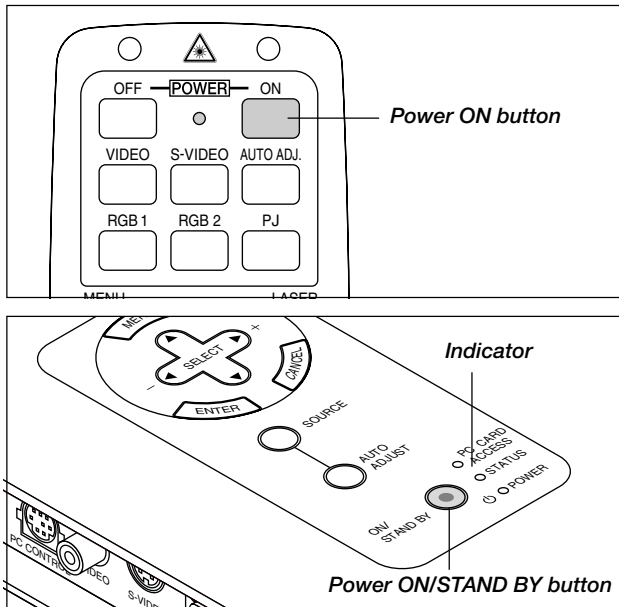

To turn on the projector:
Only after you press the "On" button on the remote control ("ON/STAND BY" button on the projector cabinet) will the power indicator turn to green and the projector become ready to use.

NOTE: To turn the projector on by plugging in the power cable, use the menu and enable the "Auto Start" feature. (See page E-38.)

NOTE: Immediately after turning on the projector, screen flicker may occur. This is not a fault. Wait 3 to 5 minutes until the lamp lighting is stabilized.

To turn off the projector:
First press the "off" button on the remote control ("ON/STAND BY" button on the projector cabinet) for a minimum of two seconds. The power indicator will glow orange. After the projector turns off, the cooling fans keep operating for one minute.

NOTE: Do not disconnect the power cable during this time. Then, unplug the power cable. The power indicator will go out.

Status of indicator light: turn on

High-Bright mode:

stand by

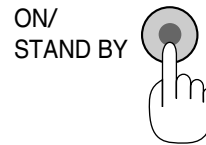
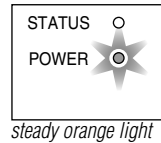

flashing one minute

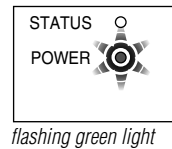

steady light

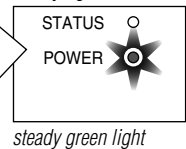

Eco mode:

stand by

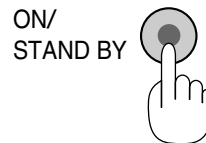
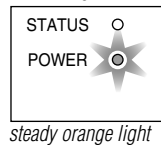

flashing one minute

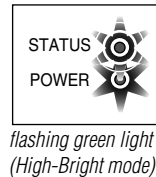

steady light

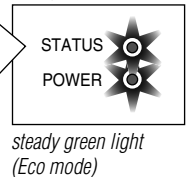

Status of indicator light: turn off

ON

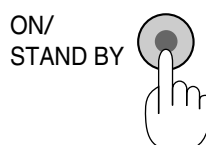
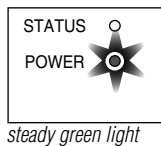

Press a minimum of two seconds.

cooling down

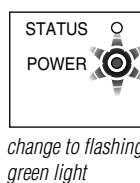

stand by

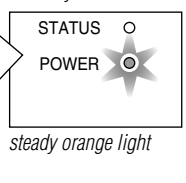

3. Adjust a Projected Image

Select the Computer or Video Source

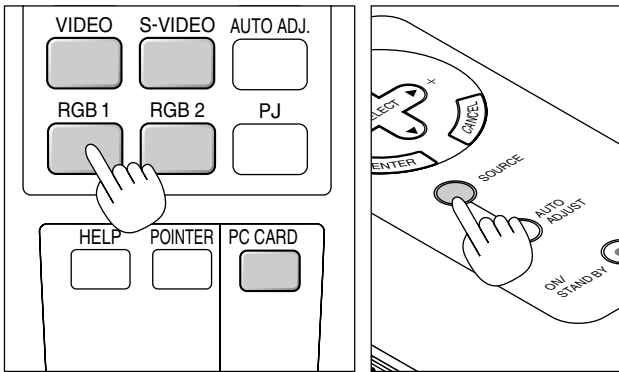

Press the Source button on the remote control or the projector cabinet to select "Video" (VCR, document camera, or laser disc player), S-Video, "RGB" (computer or DVD with component output) ["DVI digital", "DVI analog" (computer with DVI output: LT156 only)] or "PC Card Viewer" (slides on a CompactFlash card) to display the image. Or press the "Menu" button on the remote control or the cabinet and use the menu to select your video source: "Video", "S-Video", "RGB (DVI on LT156)" or "PC Card Viewer".

NOTE: If no input signal is available, the projector will display a blue background (factory preset).

Adjust the Image Size and the Focus

Use the Zoom lever to fine adjust the image size on the screen

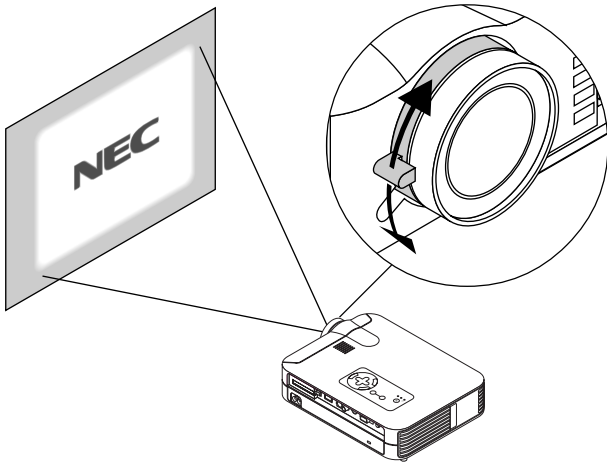

Use the Focus ring to obtain the best focus.

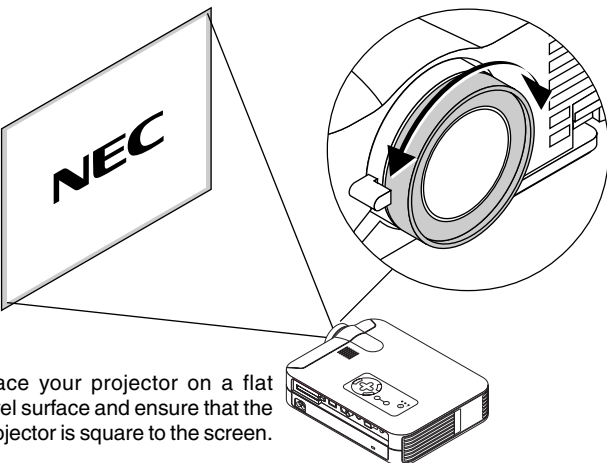

Place your projector on a flat level surface and ensure that the projector is square to the screen.

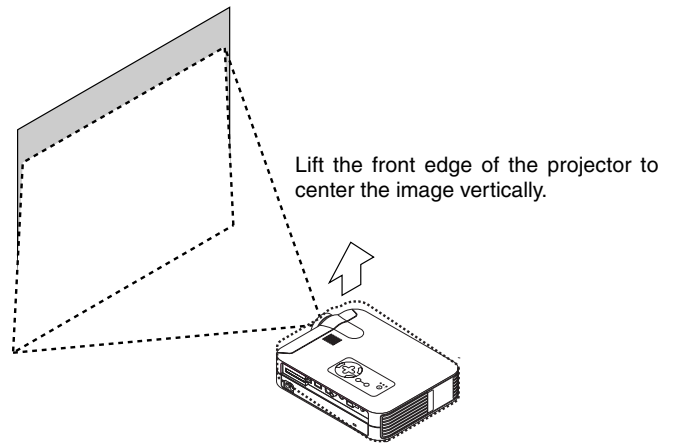

Lift the front edge of the projector to center the image vertically.

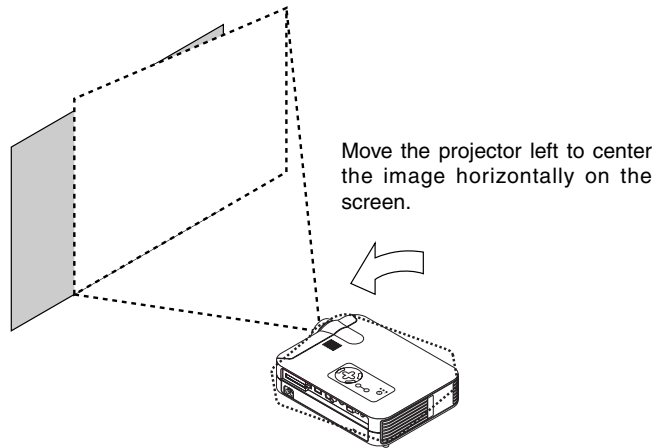

Move the projector left to center the image horizontally on the screen.

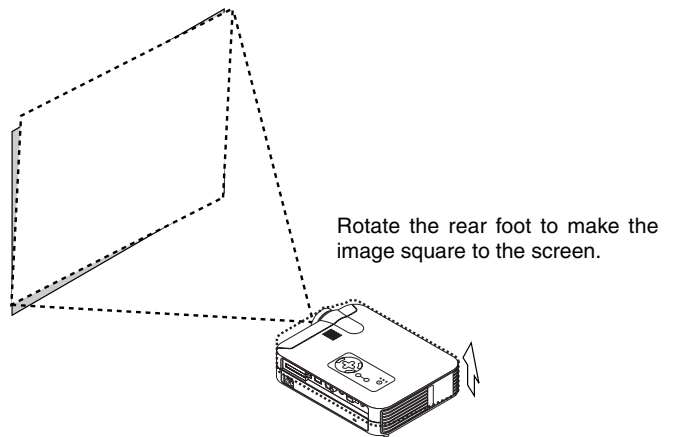

Rotate the rear foot to make the image square to the screen.

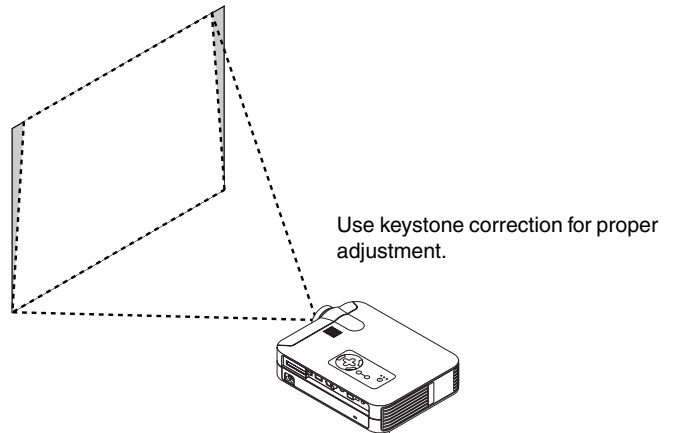

Use keystone correction for proper adjustment.

Adjust the Tilt Foot

1. Lift the front edge of the projector.
2. Press the Tilt button on the front of the projector to extend the adjustable tilt foot (maximum height).

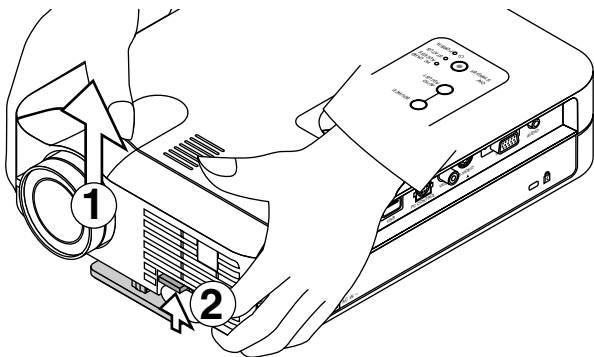

3. Press and hold the Tilt button.
4. Lower the front of the projector to the desired height and release the button to lock the Adjustable tilt foot. There is approximately 10 degrees of up and down adjustment for the front of the projector.

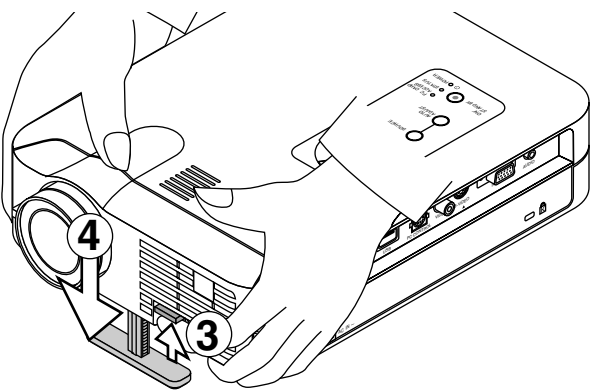

Do not use the tilt-foot for purposes other than originally intended. Misuses such as gripping the tilt-foot or hanging on the wall can cause damage to the projector.

To fine-adjust the height of the rear foot, remove the spacer (black rubber) and rotate the rear foot to the desired height.

* If the projected image does not appear square to the screen then use keystone correction for proper adjustment.

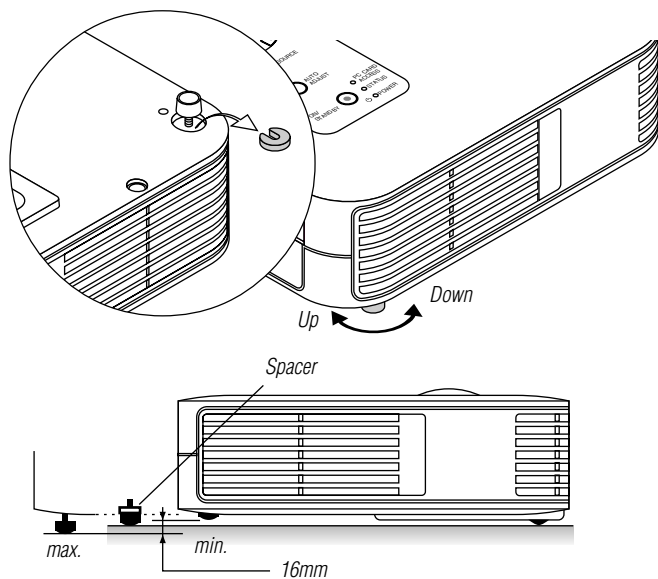

Adjust the Image Using Auto Adjust

The Auto Adjust function automatically optimizes the image in RGB mode.

[Poor picture]

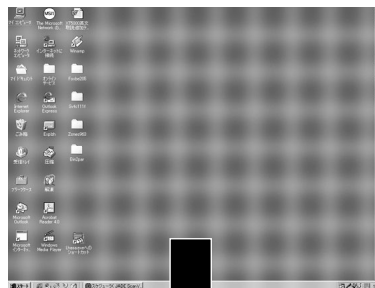

[Normal picture]

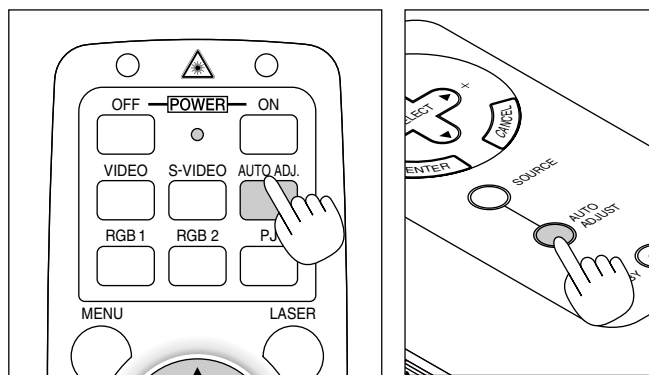
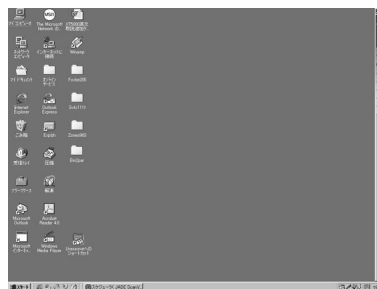

Press the Auto Adjust button to adjust Position-H/V and Pixel Clock/Phase for an optimal picture. Some signals may not be displayed correctly or take time to switch between sources.

NOTE: For LT156

* The horizontal and vertical position adjustments to DVI digital signal are not stored in memory on LT156.

* The Pixel Clock and Phase items are not available for DVI digital signal on LT156.

Basic Operation

Selecting the computer or video source:

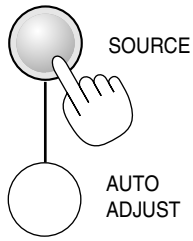

Each time the Source button is pressed, the input source will change as follows:

→ RGB ["DVI (DIGITAL) → DVI (ANALOG)" on LT156] → Video → PC Card Viewer ← S-Video ←

If no input signal is present, the input will be skipped.

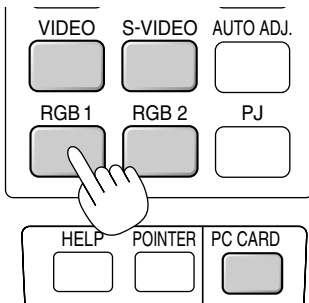

On LT156:

Press the RGB 1 button on the remote control to select DVI digital signal and the RGB 2 button for DVI analog signal.

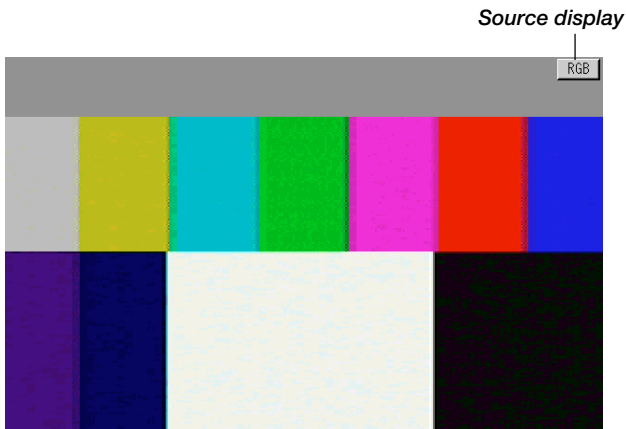

Optimizing RGB image automatically

Press the Auto Adjust button to optimize an RGB image automatically.

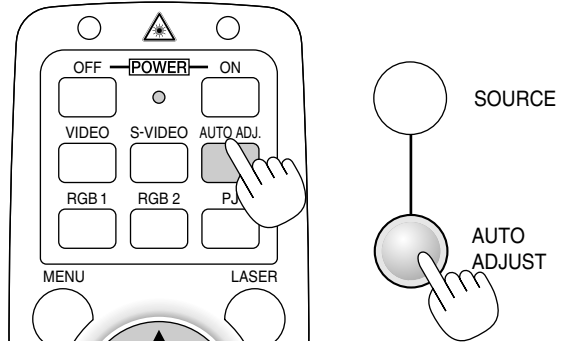

Press the Auto Adjust button to fine-tune the computer image or to remove any vertical banding that might appear and to reduce video noise, dot interference or cross talk (this is evident when part of your image appears to be shimmering). This function adjusts the clock frequencies that eliminate the horizontal banding in the image. This function also adjusts the clock phase to reduce video noise, dot interference or cross talk. (This is evident when part of your image appears to be shimmering.) This adjustment may be necessary when you connect your computer for the first time.

NOTE: The Auto Adjust function does not work for component signal.

Volume control:

Sound level from the speaker on the projector can be adjusted.

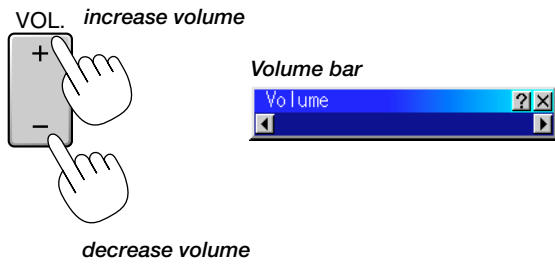

Turning off picture and sound:

Press the Picture Mute button to turn off the image and sound for a short period of time. Press again to restore the image and sound.



Getting Help about how to operate the projector:

You get the contents about Help.

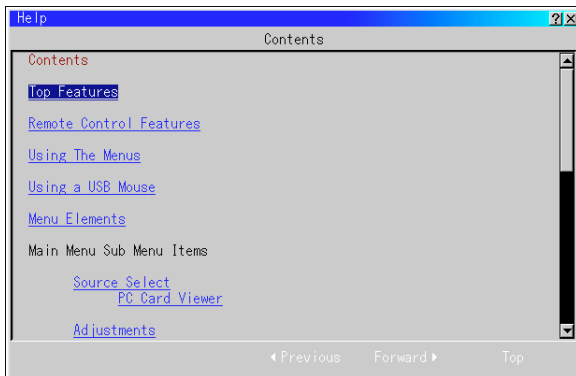
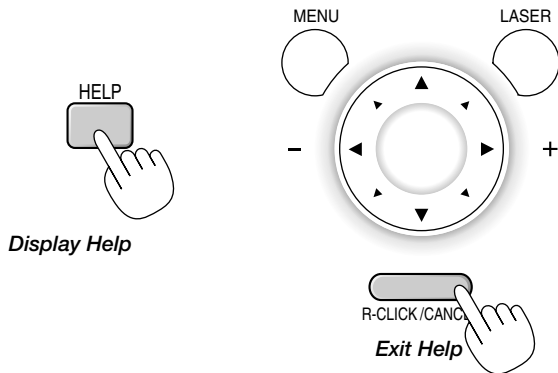

Using Pointer

You can use one of eight pointers to draw your audience's attention to the portion of a projected image you want.



Press the Pointer button to display the pointer.

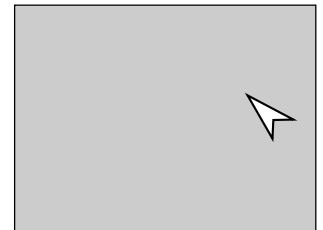
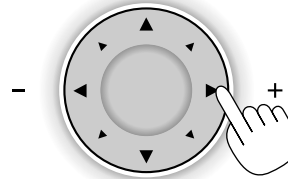
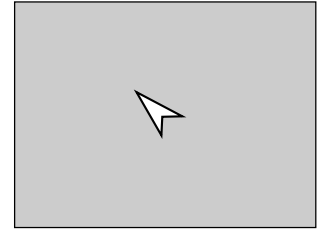

Enlarging and Moving a Picture

You can enlarge the area you want up to 400 percent.

To do so:

1. Press the Pointer button to display the pointer.

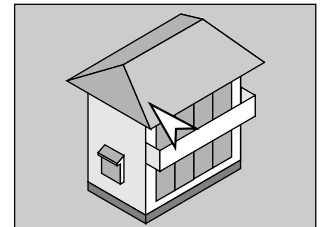

2. Move the pointer to the area you want to enlarge.

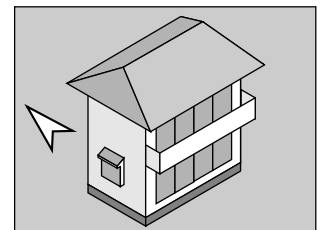
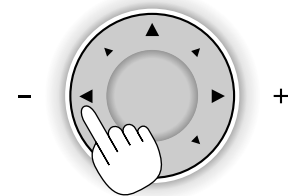

3. Enlarge the selected area.

When the Magnify (+) button is pressed, the pointer is changed to a magnifying glass. To move the magnifying glass, use the Mouse button.

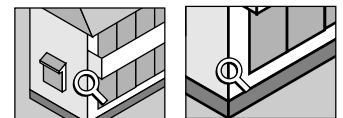
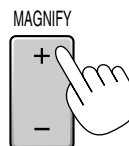

4. Return the image to the original size.

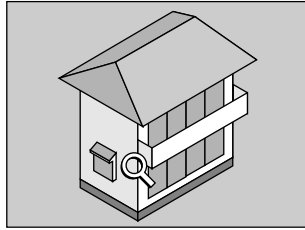
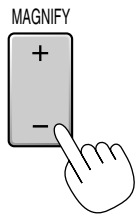

Correcting Keystone distortion

Press (+) or (-) to correct keystone (trapezoidal) distortion to make the top or bottom of the screen longer or shorter so that the projected image is rectangular.

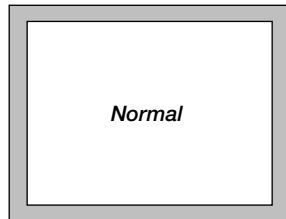
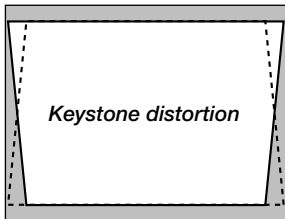

NOTE: The maximum keystone angle that can be corrected is 40 degrees upward and 20 degrees downward with the projector placed horizontally on the ground plane.

Depending on the type of graphics being used, the picture may get blurred or keystone correction may not be possible when excessive keystone correction is used.

The idea is, the closer you are to native resolution, the better image you will see.

Freezing a picture

Press the Freeze button to freeze a picture. Press again to resume motion.



Using the Menu

NOTE: The on-screen menu may not be displayed correctly while interlaced motion video image is projected.

1. Press the "Menu" button on the remote control or projector cabinet to display the Main Menu.

NOTE: When using a USB mouse, click the mouse button to display the main menu. For other operations, do the same way as you use your PC mouse.

2. Press the ▲▼ buttons on the remote control or the projector cabinet to highlight the menu for the item you want to adjust or set.

3. Press the ► button or the "Enter" button on the projector cabinet or the "Left Click" button on the remote control to select a submenu or item.

4. Adjust the level or turn the selected item on or off by using "Select" ◀ or ▶ buttons on the cabinet, or the "Mouse button" on the remote control. The on-screen slide bar will show you the amount of increase or decrease.

5. Changes are stored until you adjust it again.

ENTER Stores the setting or adjustments.

CANCEL Return to the previous screen without storing settings or adjustments.

NOTE: You can close the main and sub menus simultaneously by pressing the PJ button to cancel the Projector mode.

6. Repeat steps 2-5 to adjust an additional item, or press "Cancel" on the projector cabinet or the remote control to quit the menu display.

Customizing Basic/Custom Menu

The Basic/Custom menu can be customized to meet your requirements. Selecting a menu item from the "Basic/Custom Menu Edit" list, allows you to custom tailor the menu items to your needs.

1. Select "Basic/Custom Menu Edit" to display the "Basic/Custom Menu Edit" screen.

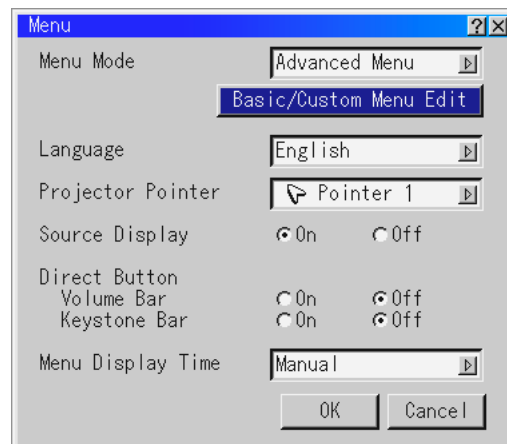

2. Use the ▲ or ▼ button to highlight your selection and press the Enter button to place a check mark next to an option. This action enables that feature. Press the Enter button again to clear the check box.

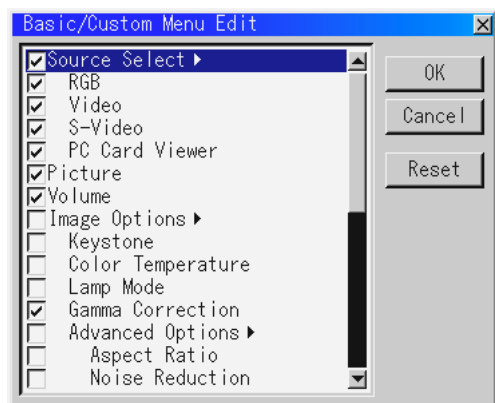

If you select an item with a solid triangle ▶ and press the Enter button on the remote control or the projector cabinet, you can enable all the items within that submenu. Also you can turn on an item within the submenu without placing a check mark on the main menu item.

NOTE: Up to 12 main menu items (within Basic/Custom Menu Edit, not including submenu items) can be selected.

3. In order for the changes to take effect, use the ◀ or ▶ button on the remote control or the projector cabinet to highlight “OK”, then press the Enter button. To cancel the changes, use the ▲ or ▼ buttons to highlight “Cancel” and press the “Enter” button. To return to the factory default, select “Reset” then press the “Enter” button.

The default Basic/Custom Menu items are:

Source Select (RGB [DVI (DIGITAL) / DVI (ANALOG) on LT156], Video, S-Video and PC Card Viewer), Picture, Volume, Image Options (Keystone, Color Temperature and Lamp Mode), Projector Options (Menu and Setup), Tools (Capture, PC Card Files and ChalkBoard) and Help (Contents and Information)

NOTE: Once you have selected OK on the Basic/Custom Menu Edit screen, you cannot cancel the changes on the Menu screen. However, you can re-edit the menu items over again as described in the steps above.

NOTE: If the “Advanced Menu” item has been selected on the Menu mode, you get the “Confirmation Change Menu” upon completion of “Basic/Custom Menu” editing. In this case, selecting “Yes” then “Enter” will close all the menus and apply the changes from the Advanced menu to the Basic/Custom Menu. If you select “No” then “Enter” functions, then all menu items will return to the Advanced menu, but your changes will still be available within the “Basic/Custom Menu” selection. To display the previously tailored Basic/Custom Menu, select “Basic/Custom Menu” from the “Menu Mode”.

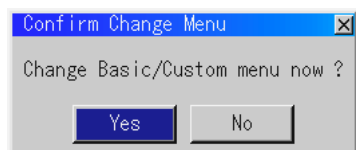

An item “To Advanced Menu” will be added to the bottom of the Basic/Custom Menu. Selecting this item and pressing the “Enter” button will display the “Advanced Menu” features.

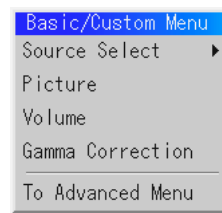

Using a USB Mouse

Using a USB mouse gives you a smooth operation. A commercially available USB mouse is required.

NOTE: There may be some brands of USB mouse that the projector does not support.

Operate the Menus using the USB mouse:

Mouse Cursor:
When connecting a USB mouse to the projector, you get a mouse cursor on the screen. Unless you use your USB mouse within 10 seconds, the mouse cursor disappears.

Menu Display:
Clicking with a mouse button displays the main menu.
Clicking ▶ displays the pull-down menu.
To close the menu, click anywhere in the background.

Adjusting and Setting Display:
You can select a menu item and click with a mouse button to make adjustments and setting.

Examples:
Click (or press and hold) the mouse button ◀ or ▶ to adjust the brightness.
Or click and drag the mouse button on the slide bar horizontally to adjust it.
To save the adjustments, click [X]. The display is closed.
If you click anywhere in the background while displaying adjustment and setting menu or dialog box, you will get the main menu at the clicking point.

Menu Tree

NOTE:

- 1) When menu items are not available, they are indicated in white.
- 2) **For LT156:** When DVI (DIGITAL) is selected, making any adjustment executes the Auto Adjust feature. The AUTO ADJUST button on the remote control is also available. You can adjust the horizontal and the vertical position for DVI digital signal but cannot save those adjustments.

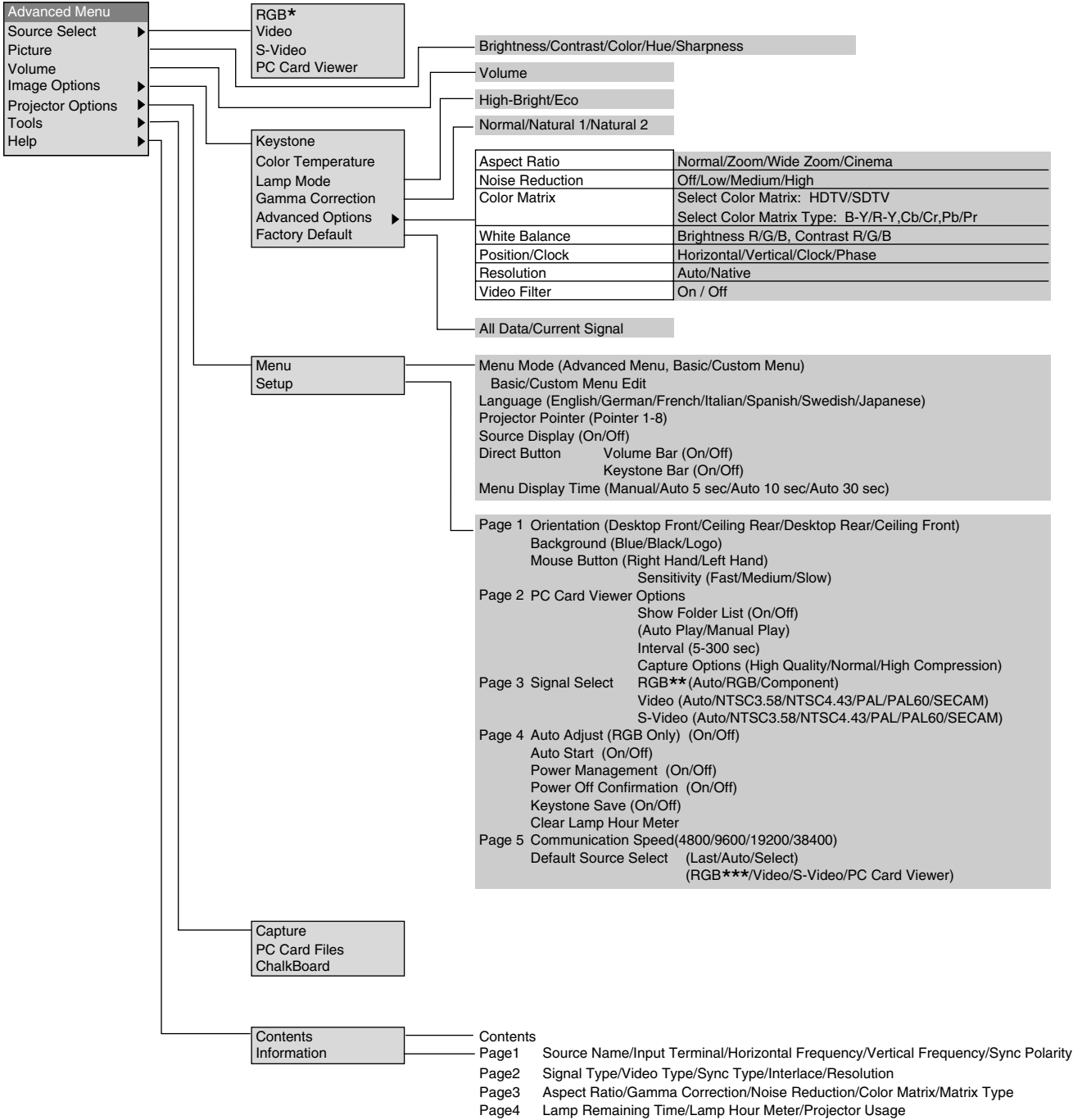

NOTE:

- * On LT156, "DVI (DIGITAL)" and "DVI (ANALOG)" are displayed in the Source Select submenu.
- ** On LT156, "DVI (ANALOG)" is displayed in the Signal Select on Page 3.
- *** On LT156, "DVI (DIGITAL)" and "DVI (ANALOG)" can be also selected.

Menu Elements

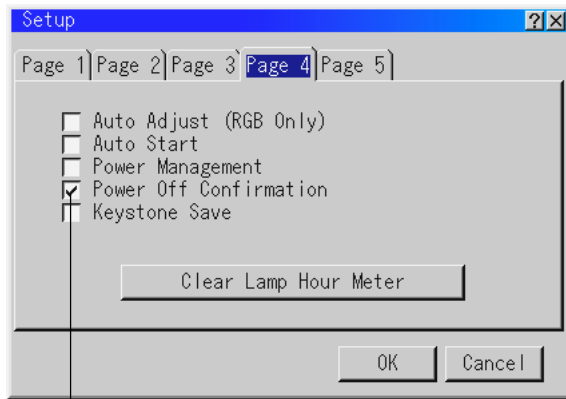
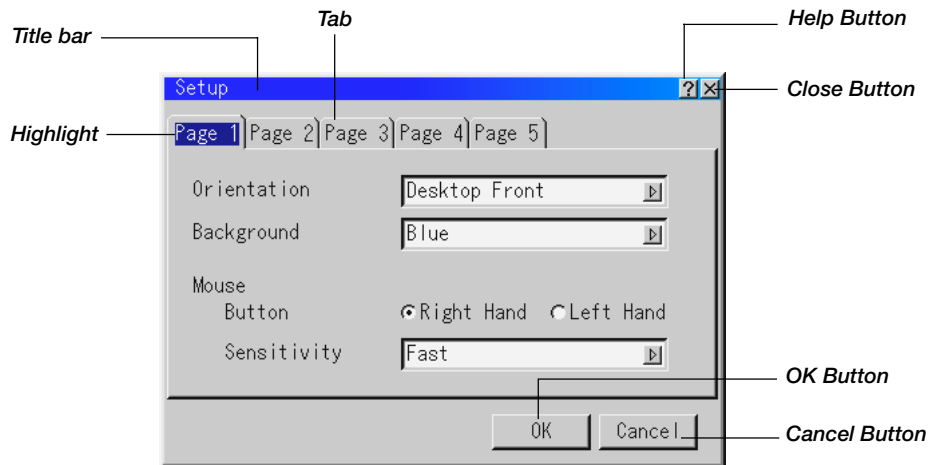

Check box

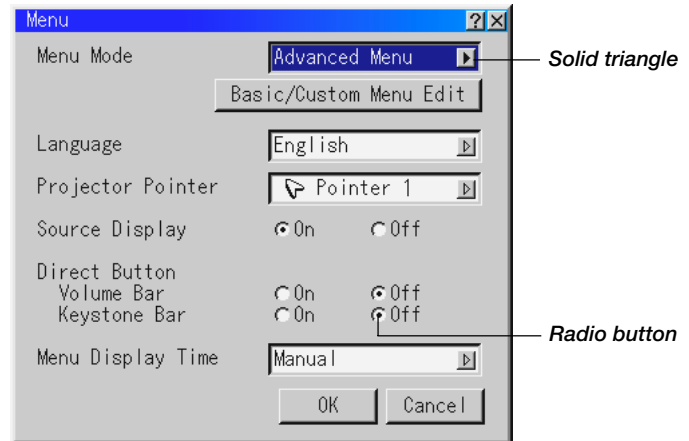

Solid triangle

Radio button



Drag

Tool bar



Slide bar

Menu windows or dialog boxes typically have the following elements:

- Title bar:** Indicates the menu title.
- Highlight:** Indicates the selected menu or item.
- Solid triangle:** Indicates further choices are available. A highlighted triangle indicates the item is active.
- Tab:** Indicates a group of features in a dialog box. Selecting on any tab brings its page to the front.
- Radio button:** Use this round button to select an option in a dialog box.
- Check box:** Place a checkmark in the square box to turn the option On.
- Slide bar:** Indicates settings or the direction of adjustment.
- OK button:** Press to confirm your setting. You will return to the previous menu.
- Cancel button:** Press to cancel your setting. You will return to the previous menu.
- Close button:** Click to close the window with saving changes. (USB mouse only)
- Help button:** Indicates that help about that feature is available (USB mouse only). Press the Help button on the remote control to display help.
- Toolbar:** Contains several icons for specific tasks. It is also referred to as "launcher".
- Drag:** Point the mouse here, and click and drag to move a toolbar.

Menu Descriptions & Functions

Source Select

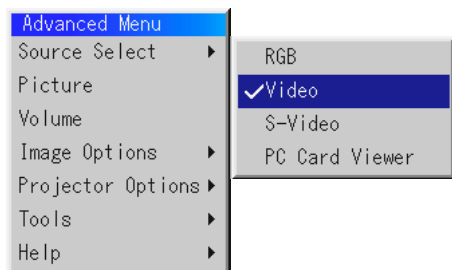

Enables you to select a video source such as a VCR, DVD player, laser disc player, computer or document camera depending on what is connected to your inputs.

Press the "Select" button on the projector cabinet or ▲▼ buttons on your remote control to highlight the menu for the item you want to adjust.

RGB (DVI on LT156 only)

Selects the computer connected to your RGB, DVI-digital, DVI-analog or component signal.

NOTE: An optional component cable (Component V cable) is needed for a component signal. Select "Component" from the Input Signal submenu to display the component signal.

Video

Selects what is connected to your Video input-VCR, laser disc player, DVD player or document camera.

S-Video

Selects what is connected to your S-Video input-VCR, DVD player, or laser disc player.

NOTE: A frame may freeze for a brief period of time when a video is played back in fast-forward or fast-rewind with a Video or S-Video source.

PC Card Viewer

This feature enables you to make presentations using a CompactFlash card that contains captured images and slides created with the exclusive PC Card Viewer Utility contained in the CD-ROM. See page E-42 for installing the PC Card Viewer Utility. The starting screen for the PC Card Viewer varies depending on the settings of the Setup's Page 2. See Setup on page E-37.

NOTE: Even if you switch the current PC Card Viewer source to another source, the current slide is retained. When you return back to the PC Card Viewer, you will get the slide that has been retained. A launcher will appear when you press the MENU button.

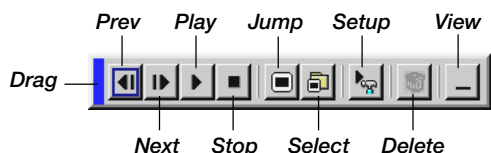
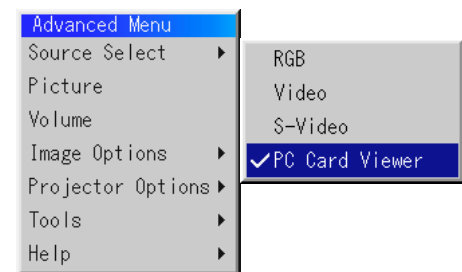

A press of the MENU button displays the toolbar; a press of the MENU button again displays the Menu and hereafter each press of the MENU button switches displaying between the Menu and the toolbar.

The launcher is a tool bar including the following buttons:

- Drag Drags to move the tool bar. (for USB mouse operation only)
- Prev Returns to the previous slide or folder.
- Next Advances to the next slide or folder.
- Play Plays back automatically or manually depending on the setting on PC Card Viewer Options of the menu. This allows you to move on to the next slide when "Manual Play" is selected.
- Stop Stops Auto Play while you are playing back and to resume playing from the selected slide or folder when "Auto Play" is selected.
- Jump Displays a list of slides while you are playing back.
- Select Displays a list of folders while you are playing back.
- Setup Displays the PC Card Viewer Options dialog box on Page 2 of the Setup dialog box.
- Delete Deletes a captured slide(s) or all the captured slides in the selected folder.
- View Hides the tool bar while you are playing back. Clicking with the right button of a mouse shows it again.

Picture



Provides access to controls for your image. Use ▲▼ buttons on the projector cabinet or the remote control to highlight the menu for the item you want to adjust.

- Brightness ... Adjusts the brightness level or the back raster intensity.
- Contrast Adjusts the intensity of the image according to the incoming signal. (not valid for DVI digital on LT156)
- Color Increases or decreases the color saturation level (not valid for RGB).
- Hue Varies the color level from +/- green to +/-blue. The red level is used as reference. This adjustment is only valid for Video and Component inputs (not valid for RGB).
- Sharpness Controls the detail of the image for Video (Not valid for RGB and Component).

Volume



Adjusts the sound level of the projector.

NOTE: You can also display the volume bar without opening the menu. See "Volume Bar (Direct Button)" on page E-36 for more details.

Image Options

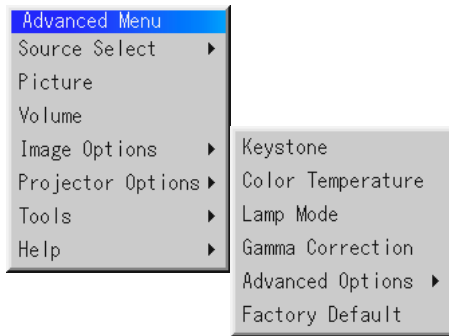

Keystone



This feature corrects the keystone (trapezoidal) distortion to make the top of the screen longer or shorter to be the same as the bottom. Use the ◀ or ▶ buttons on the slide bar to correct the keystone (trapezoidal) distortion.

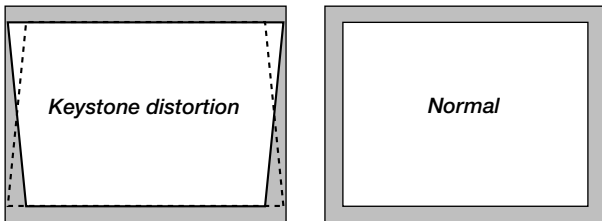

NOTE: The maximum keystone angle that can be corrected is 40 degrees upward and 20 degrees downward with the projector placed horizontally on the ground plane.

Depending on the type of graphics being used, the picture may get blurred or keystone correction may not be possible when excessive keystone correction is used.

The idea is, the closer you are to native resolution, the better image you will see.

Color Temperature

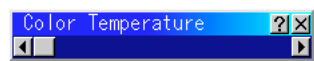

This feature adjusts the color temperature using the slide bar. Move the slide bar to the right to increase the color temperature for a bluish image; to the left to decrease it for a reddish image.

Lamp Mode

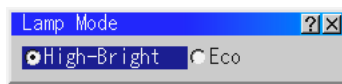

This feature enables you to select two brightness mode of the lamp: High-Bright and Eco modes. The lamp life can be extended up to 2000 hours by using the Eco mode.

High-Bright Mode This is the default setting.
Eco Mode Select this mode to increase the lamp life.

NOTE: If you have selected the Eco mode, the lamp lights in High-Bright mode for one minute after the projector is turned on. After one minute the lamp will change to Eco mode.

Gamma Correction

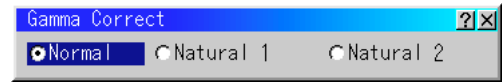

Use the ◀ or ▶ button to choose "Normal" when in a lighted room and "Natural 1&2" when in a darkened room. "Natural 1" for better flesh tone; "Natural 2" for true reproduction of middle tones. Each mode is recommended for :

Normal For the regular picture
Natural 1 For true color reproduction of natural tones
Natural 2 For dark portions of a picture

Aspect Ratio

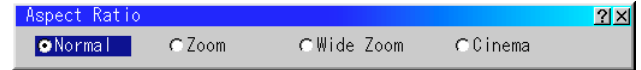
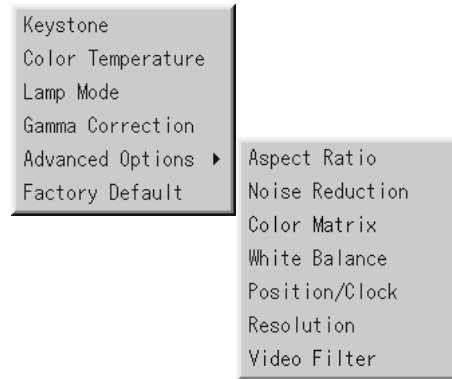

Aspect Ratio allows you to select the best Aspect mode to display your source image.

When 4:3 is selected from the source (i.e. DVD player), the following selections will display:

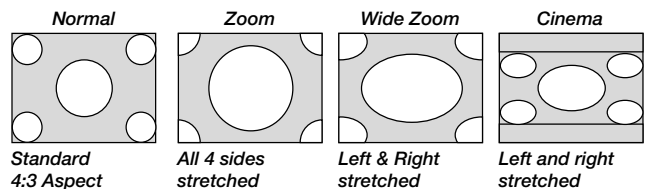

When 16:9 is selected from the source (i.e. DVD player), the following selections will display:

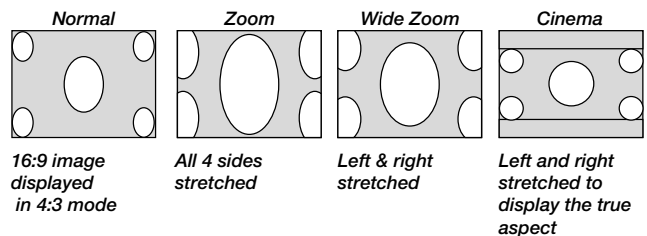

Noise Reduction



You can select three levels video noise reduction.

NOTE: The lower the Noise Reduction level, the better the image quality by way of higher video bandwidth.

Color Matrix

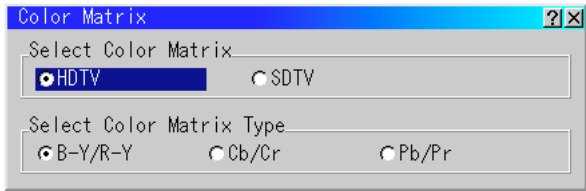

First select an appropriate color matrix to fit your component signal for HDTV or SDTV. Then select an appropriate matrix type from B-Y/R-Y, Cb/Cr or Pb/Pr.

White Balance



This allows you to adjust the white balance. Brightness for each color (RGB) is used to adjust the black level of the screen; Contrast for each color (RGB) to adjust the white level of the screen. First use the ▲ or ▼ buttons to select R, G, or B for the brightness and the contrast. Next use the ◀ or ▶ buttons to adjust the level.

Position/ Clock (when Auto Adjust is off)

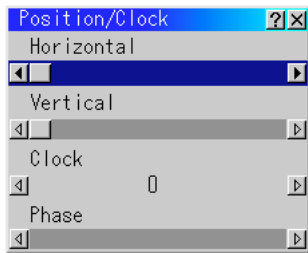

This allows you to manually adjust the image horizontally and vertically, and adjust Clock and Phase.

Horizontal/Vertical Position

..... Adjusts the image location horizontally and vertically using the ◀ and ▶ buttons. This adjustment is made automatically when the Auto Adjust is turned on.

Clock Use this item to fine tune the computer image or to remove any vertical banding that might appear. This function adjusts the clock frequencies that eliminate the horizontal banding in the image.

Press the ◀ and ▶ buttons until the banding disappears. This adjustment may be necessary when you connect your computer for the first time. This adjustment is made automatically when the Auto Adjust is turned on.

Phase Use this item to adjust the clock phase or to reduce video noise, dot interference or cross talk. (This is evident when part of your image appears to be shimmering.) Use the ◀ and ▶ buttons to adjust the image.

See "Auto Adjust (RGB Only) on page E-38 for turning on or off the Auto Adjust feature.

Use "Phase" only after the "Clock" is complete. This adjustment is made automatically when the Auto Adjust is turned on.

Resolution (when Auto Adjust is off)



This allows you to activate or deactivate the Advanced AccuBlend feature.

Auto Turns on the Advanced AccuBlend feature. The projector automatically reduces or enlarges the current image to fit the full screen.

Native Turns off the Advanced AccuBlend feature. The projector displays the current image in its true resolution.

See "Auto Adjust (RGB Only) on page E-38 for turning on or off the Auto Adjust feature.

NOTE: While you are displaying an image with higher resolution than the projector's native resolution, even when you are in the Native mode, the image is displayed full screen using the Advanced AccuBlend feature.

Video Filter (when Auto Adjust is off)

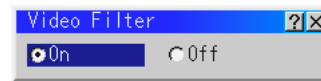

This function reduces video noise.

On The low-pass filter is applied.
Off The filter is removed.

Screen adjustments are possible even when the filter is On.

Factory Default

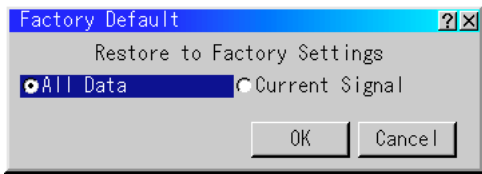

Changes all adjustments and setting to the factory preset for each source individually except Lamp Hour Meter, Projector Usage, Language and Communication Speed. (To reset the lamp usage time, see "Clear Lamp Hour Meter" on page E-38.)

- All Data Reset all the adjustments and settings for all the signals to the factory preset.
- Current Signal Resets the adjustments for the current signal to the factory preset levels.

The items that can be reset for the currently projected image are: Picture (Brightness, Contrast, Color, Hue and Sharpness) and Image Options (Color Temperature, Gamma Correction, Advanced Options [Aspect Ratio, Noise Reduction, Color Matrix, White Balance, Position/Clock, Resolution and Video Filter]).

NOTE: The Volume, Keystone, Lamp Mode and all the items in the Projector Options can be reset only when "All Data" is selected.

Projector Options

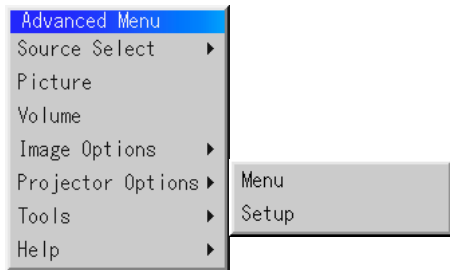

Menu



Allows you to set preferences for the on-screen menu. Press "OK" to save your changes for all the features.

Menu Mode:

This feature allows you to select two menu modes: Advanced Menu and Basic/Custom Menu.

Advanced Menu This is the menu that contains all the available menus and commands.

Basic/Custom Menu This is the menu that you can customize using the Basic/Custom Menu Edit to fit your needs.

The factory default Basic/Custom menu includes:

Source Select (RGB [DVI (DIGITAL) / DVI (ANALOG) on LT156], Video, S-Video and PC Card Viewer), Picture, Volume, Image Options (Keystone, Color Temperature and Lamp Mode), Projector Options (Menu and Setup), Tools (Capture, PC Card Files and ChalkBoard) and Help (Contents and Information). See page E-29 for instructions about how to customize the Basic/Custom Menu.

Language:

You can choose one of seven languages for on-screen instructions. The options are: English, German, French, Italian, Spanish, Swedish and Japanese.

Projector Pointer:

This enables you to select from eight different Pointer icons for the "Pointer" button on your remote control.

After moving your Pointer icon to the area you want on the screen, press the Magnify button on the remote control to enlarge the selected area on the screen. See page E-28 for more details.



NOTE: There may be cases where the Pointer function is not available (ex. a non-interlace signal at 15kHz such as video game.)

Source Display:

You can turn on and off the information for input name such as VIDEO and RGB.

When this option is on, the current input will be displayed each time you switch sources or turn on the projector.

Direct Button:

Volume Bar: This option turns on or off the volume bar when you adjust the sound volume using VOL+/- button on the remote control.

On You can increase or decrease the sound volume with the volume bar on screen. If no adjustments are performed within 3 seconds, the Volume bar will disappear.

Off You can increase or decrease the sound volume without having to use the volume bar.

Keystone Bar: This option turns on or off the keystone bar when you adjust the keystone using KEYSTONE +/- button on the remote control.

On You can increase or decrease the level with the keystone bar on screen. If no adjustments are performed within 3 seconds, the Keystone bar will disappear.

Off You can increase or decrease the level without having to use the keystone bar.

Menu Display Time :

This option allows you to select how long the projector waits after the last touch of a button to turn off the menu.

The preset choices are "Manual", "Auto 5 sec", "Auto 10 sec", and "Auto 30 sec". The "Auto 10 sec" is the factory preset.

Manual The menu can be turned off manually.

Auto 5 sec The menu will automatically be turned off in 5 seconds if no buttons are pressed within 5 seconds.

Auto 10 sec .. The menu will automatically be turned off in 10 seconds if no buttons are pressed within 10 seconds.

Auto 30 sec .. The menu will automatically be turned off in 30 seconds if no buttons are pressed within 30 seconds.

NOTE: If no buttons on the remote control are pressed within 10 seconds, the PJ button's light goes out to indicate that you are in the Computer mode. To enable the projector menu operation again, press the PJ button again to light red.

Setup

Enables you to set operating options. Press "OK" to save your changes for all the features of Page1, Page2, Page3, Page 4 and Page5.

[Page1]

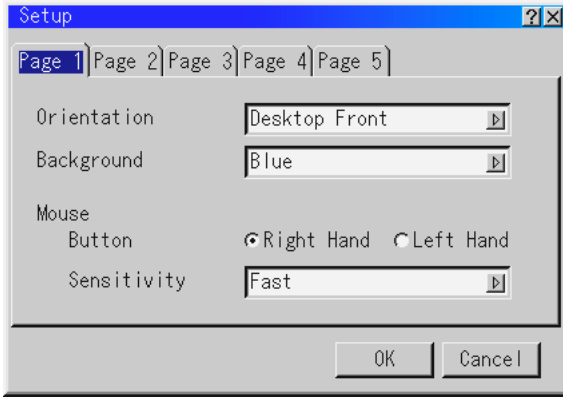

Orientation:

This reorients your image for your type of projection. The options are: desktop front projection, ceiling rear projection, desktop rear projection, and ceiling front projection.

Background:

Use this feature to display a blue/ black screen or logo when no signal is available. The default background is blue. You can change the logo screen using the PC Card Files feature. See page E-40.

Mouse Settings:

This option lets you to change your USB mouse settings. The mouse settings feature is available for USB mouse only. Choose the settings you want:

Mouse Button "Right Hand" or "Left Hand"
Mouse Sensitivity "Fast", "Medium" or "Slow"

[Page2] PC Card Viewer Options

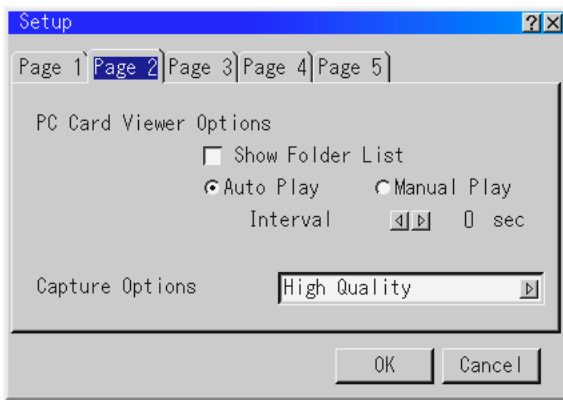

Show Folder List:

If this option is checked, when PC Card Viewer input is selected on the projector, the folder lists will be displayed and allows you to select the presentation from a CompactFlash card.

Auto Play:

If this option is checked, any given slide will start to play automatically.

Auto Play Interval:

You can specify interval time between 5 and 300 seconds.

NOTE: The Auto Play Interval time set on the PC Card Viewer Utility overrides the one set here.

Manual Play:

Views a slide manually when PC Card Viewer input is selected.

NOTE: The Auto Play and Manual Play options determine the behavior of the Play/Stop [] / [] icon on the Viewer toolbar.

NOTE: If you check "Auto Play" and select "PC Card Viewer" on the projector, the slides will automatically start to play back from any given slide.

Capture Options: (available for JPEG only)

These options are used for the Capture function that you can select from Tools. You have three options for JPEG compression quality: High quality, Normal and High Compression.

High Quality . Gives quality of JPEG a priority.
Normal Gives normal JPEG quality.
High Compression Gives compression a priority.

[Page3] Signal Select

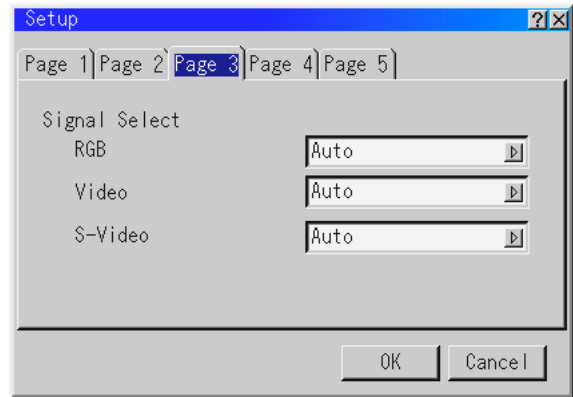

RGB on LT155 and LT154/DVI (ANALOG) on LT156:

Allows you to choose "RGB" for an RGB source such as a computer, or "Component" for a component video source such as a DVD player. Normally select "Auto" and the projector automatically detects a component signal. However there may be some component signals that the projector is unable to detect. If this is the case, select "Component".

VIDEO and S-VIDEO:

This feature enables you to select composite video standards manually. Normally select "Auto". Select the video standard from the pull-down menu. This must be done for Video and S-Video separately.

[Page4]

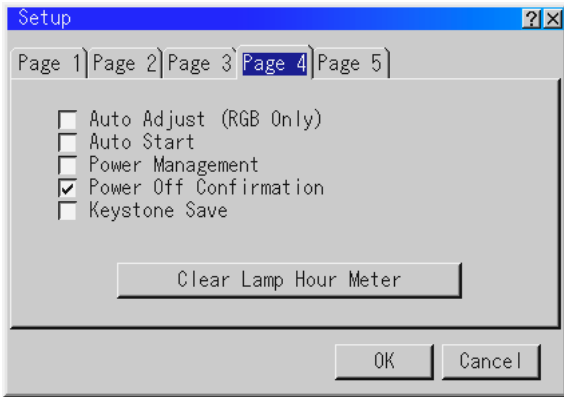

Auto Adjust (RGB Only):

When "Auto Adjust" is set to "On", the projector automatically determines the best resolution for the current RGB input signal to project an image using NEC's Advanced AccuBlend Intelligent Pixel Blending Technology.

The image can be automatically adjusted for position and stability; "Horizontal Position", "Vertical Position", "Clock", "Phase", and "Resolution."

On Automatically adjusts image "Horizontal Position", "Vertical Position", "Clock", "Phase" and "Resolution".

Off User can adjust the image display functions ("Horizontal Position", "Vertical Position", "Clock", "Phase" and "Resolution") manually.

NOTE: For LT156

This feature is not available for DVI (DIGITAL) signal. If you make any adjustment to DVI digital signal, the Auto Adjust feature automatically adjusts position and stability; Horizontal and Vertical Position, and Resolution. However, the horizontal and vertical adjustments will not be stored in memory.

Auto Start:

Turns the projector on automatically when the power cable is inserted into an active power outlet. This eliminates the need to always use the "Power" button on the remote control or projector cabinet.

Power Management:

When this option is on and there is no RGB input for five minutes or more, the projector will automatically turn itself off.

Power Off Confirmation:

This option determines whether a confirmation dialog for turning off the projector will appear or not.

NOTE: *When the confirmation message is displayed, you must be in the Projector mode to operate your projector using the remote control. If not, press the PJ button on the remote control to change your projector to the Projector mode. The button lights to indicate that you are in the Projector mode.*

Keystone Save:

This option enables you to save your current keystone settings. Saving your change once affects all sources. The changes are saved when you turn off the projector.

Clear Lamp Hour Meter:

Resets the lamp clock back to zero. Pressing this button appears a confirmation dialog box. To reset the lamp usage hour, press "OK".

NOTE: *The projector will turn off and go into standby mode after 1100 hours (up to 2200 hours in Eco mode) of service. If this happens, press the "Help" button on the remote control for ten seconds to reset the lamp clock back to zero. Do this only after replacing the lamp.*

[Page5]

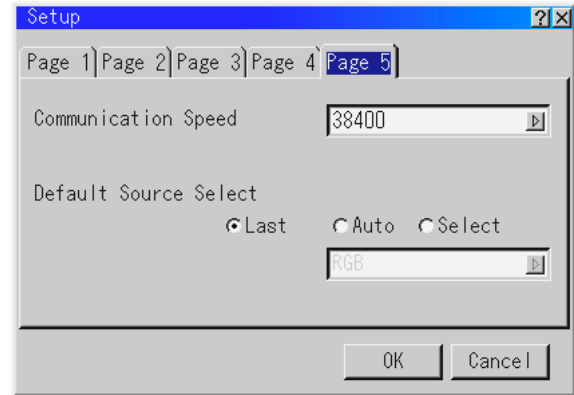

Communication Speed:

This feature sets the baud rate of the PC Control port (Mini DIN 8 Pin).

It supports data rates from 4800 to 38400 bps.

The default is 38400 bps. Select the appropriate baud rate for your equipment to be connected.

Default Source Select:

You can set the projector to default to any one of its inputs each time the projector is turned on.

Last Sets the projector to default to the previous or last active input each time the projector is turned on.

Auto Searches for an active source in order of RGB* → Video → S-Video → PC Card Viewer → RGB and displays the first found source.

Select Displays the selected source input every time the projector is started up. Select an input from the pull-down menu.

* "DVI (DIGITAL) → DVI (ANALOG)" on LT156.

Tools

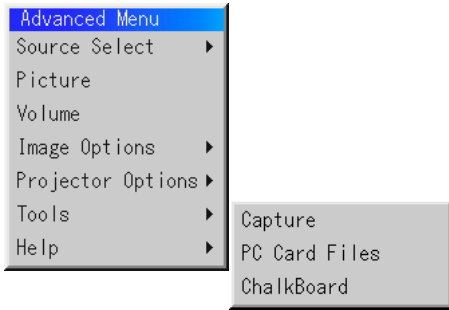

Provides tools for capturing images, displaying files in a CompactFlash Card and drawing.

NOTE: The "Capture" and "PC Card Files" features are required for a CompactFlash card.

Capture:

Allows you to capture an image from a source that is currently being displayed. The image is saved as JPEG in the CompactFlash card.

When you select Capture from the menu, you will get a tool bar. You can capture an image directly using the tool bar when the menu is not displayed.

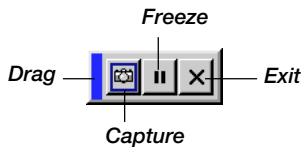

The tool bar includes the following buttons:

- Drag Drags to move the tool bar. (for USB mouse operation only)
- Capture Captures an image and save it as a JPEG file in a CompactFlash card.
- Freeze Freezes and unfreezes images.
- Exit Exits the Capture function.

Unless a CompactFlash card is inserted into the PC Card slot of the projector, the Capture feature is not available.

The "Card Error" display means that the free space of the CompactFlash card is insufficient for saving images. Make more space available on the card by erasing unwanted images with your PC. The number of images that can be captured depends on the size of the CompactFlash card.

NOTE: Be sure not to turn off the power or remove the CompactFlash card while capturing an image. Doing so could cause a loss of the data in the CompactFlash card or damage to the card itself.

NOTE: Captured images with higher resolution than the projector's native resolution cannot be displayed correctly.

PC Card Files:

Displays a list of all the files stored in the CompactFlash card so that you can select a file you want to display. You can also sort files by file name or date, or display the file.

Although a list of all the files in the CompactFlash card is displayed, you can view files in idx, text, HTML, JPEG and BMP format only. Selecting BMP and JPEG files automatically switches to the PC Card Viewer source.

NOTE: When an image with a resolution of XGA (1024x 768) or higher is projected, the PC Card Files screen may not be correctly displayed.

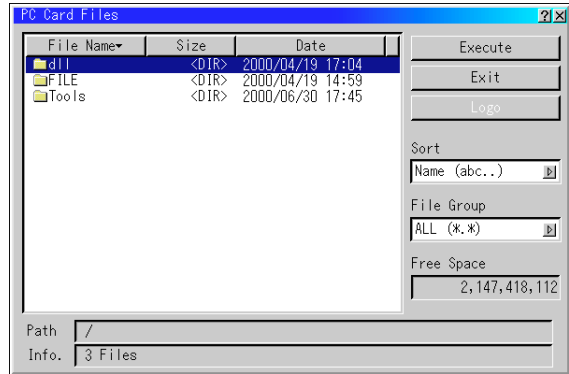

Selecting "Execute" displays the file you selected.

When you select a JPEG or BMP file and press the Enter button on the remote or the cabinet, or "Execute" on the above, you will get a toolbar. This toolbar is used to return to the PC Card Files screen.

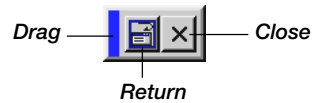

- Drag Drags to move the tool bar. (for USB mouse operation only)
- Return Returns to the PC Card Files screen.
- Close Close the toolbar.

Changing Background Logo:

The Logo button allows you to select a background logo from graphic files on a CompactFlash card and change to it as the background logo.

NOTE: File size must be 64KB or less. Other file formats than JPEG and BMP are not available.

1. Use the ▲ or ▼ button to select a JPEG or BMP file for your background logo.

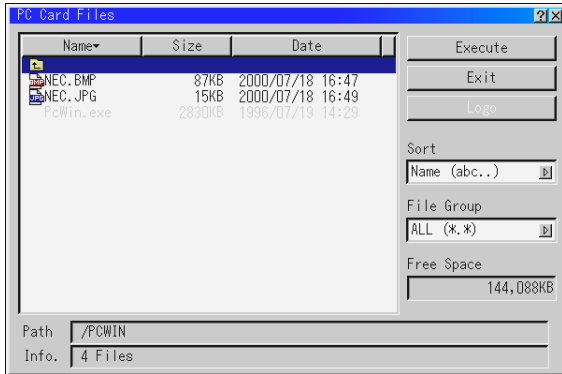

2. Use the ► and then ▼ button to select "Logo".
3. Press the Enter on the remote control or the cabinet. You will get the confirmation dialog box.

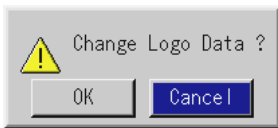

4. Select "OK" and press the Enter button. This completes changing a logo for the background.
- * Once you have changed the background from the NEC logo to another, you cannot return the logo to background even by using Factory Default. To do so, repeat the above steps. The NEC logo file is included on the supplied CD-ROM (/logo/nec_b_x.jpg).

ChalkBoard: (available only when using with USB mouse)
Provides the tool bar for producing freehand drawings.

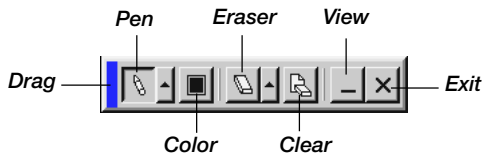

- Drag Drags to move the tool bar. (for USB mouse operation only)
- Pen Left-click and drag to draw. Left-click [▲] or right-click the pen icon to display the pen palette containing four lines of different thickness from which you can select a line you prefer by left-clicking.
- Color Selects a color. Left-click to display the color palette from which you can select a color you prefer by left-clicking.
- Eraser Left-click and drag to erase part of a drawing. Left-click [▲] or right-click the eraser icon to display the eraser palette containing four eraser of different thickness from which you can select an eraser you prefer by left-clicking.
- Clear Left-click to clear the drawing completely from the ChalkBoard screen.
- View Hides the tool bar by left-clicking. Right-clicking anywhere on the screen displays the ChalkBoard tool bar again.
- Exit Clears the complete drawing and exits the ChalkBoard.

NOTE:

- * The ChalkBoard feature is available only when a USB mouse is used. Free-hand drawings cannot be saved or captured.
- * The menu is not available while you display the ChalkBoard screen.
- * The Capture function is not available on ChalkBoard screen.
- * Switching slides clears a drawing completely.

Help

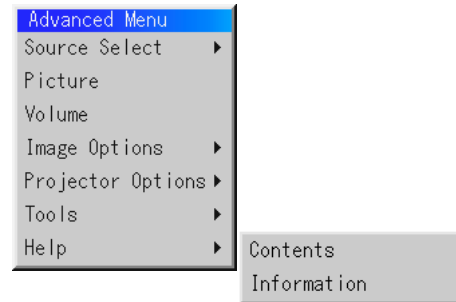

Contents:

Provides an online help about how to use the menus. An underlined link means that you can move to an adjustment item directly. Selecting the underlined link and pressing ENTER moves to the corresponding adjustment item.

NOTE: The Help Menu may not be displayed correctly when a UXGA signal is displayed.

Information:

Displays the status of the current signal, and the lamp and the projector usage hours. This dialog box has four pages.

The information included are as follows:

[Page 1]	[Page 2]
Source Name	Signal Type
Input Terminal	Video Type
Horizontal Frequency	Sync Type
Vertical Frequency	Interlace
Sync Polarity	Resolution
[Page 3]	[Page 4]
Aspect Ratio	Lamp Remaining Time (%)
Gamma Correction	Lamp Hour Meter (H)
Noise Reduction	Projector Usage (H)
Color Matrix	
Matrix Type	

NOTE: The progress indicator shows the percentage of remaining bulb life. The value informs you of the amount of lamp and projector usage respectively.

Installing the PC Card Viewer Software

Before Installing

Perform the following before installing the PC Card Viewer software:

- If Windows is already started, exit all applications. Installation may not be performed properly if any applications are running.

Installation

Install the viewer software as described below.

To quit installation before it is completed, press the "Cancel" button then follow the instructions in the dialog box.

1. Start up Windows.
2. Insert the CD-ROM into the CD-ROM drive.
The auto CD play function automatically starts the CD-ROM's program and the contents screen appears.

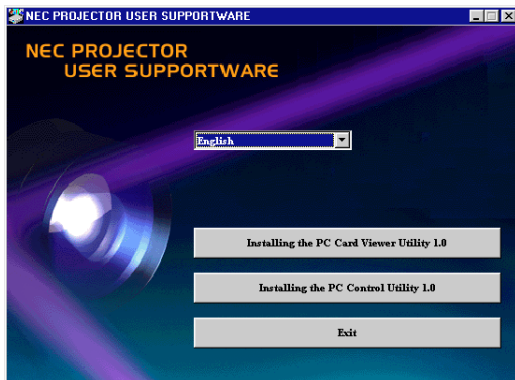

- * The auto CD play function operates if the "Auto insert notification" box in the computer's CD-ROM control panel is checked. (The box is checked by default.)

3. Click [Installing the PC Card Viewer Utility 1.0]
The setup dialog appears.

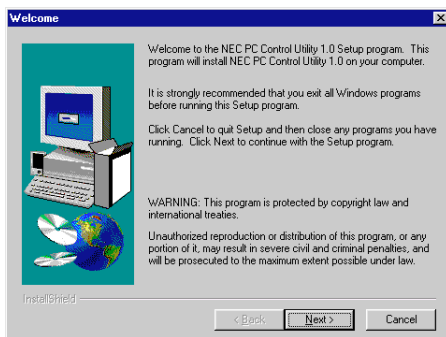

- * Follow the instructions in the setup dialog to complete the installation.

For instructions on uninstalling the PC Card Viewer software, see page E-46.

Starting Up the PC Card Viewer Software on your PC

(PC Card Viewer Utility 1.0)

Use the PC Card Viewer Utility 1.0 for creating viewer slides.

To start the PC Card Viewer software:

- * Select [Start]-[Programs]-[NEC Projector Tools]-[PC Card Viewer Utility 1.0].

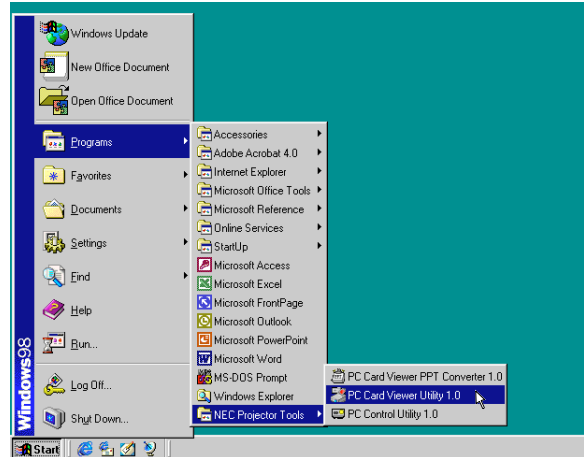

Refer to online help for instructions on using the PC Card Viewer software.

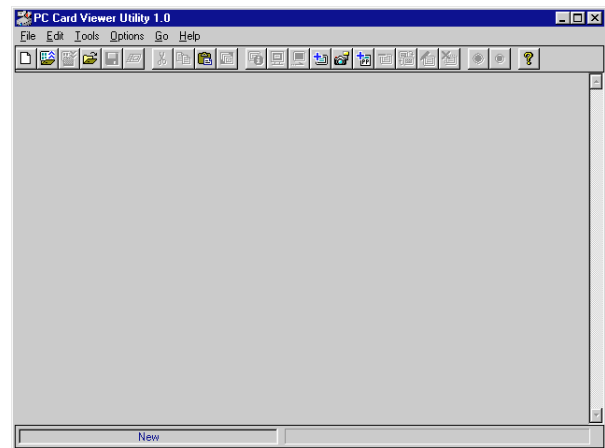

Contents of the English version PC Card Viewer software (PC Card Viewer Utility 1.0)

This is the software used for creating PC Card Viewer slides. In this manual it is referred to as the "PC Card Viewer software".

PC Card Viewer PPT Converter 1.0

This is an application that converts files created with Microsoft PowerPoint 95/97/2000 into indexes so that they can be played directly with the PC Card Viewer Utility 1.0.

PC Card Viewer PPT Converter is installed automatically when you install the PC Card Viewer Utility.

To start PC Card Viewer PPT Converter:

- * Select PC Card Viewer PPT Converter from NEC Projector Tools.

Basic Operation of the PC Card Viewer Software

PC Card Viewer Utility is an application for editing documents, converting them into slides and storing them on CompactFlash cards as playback data (indexes) for presentations using projectors.

Operating the PC Card Viewer Function from the Projector (playback)

This section describes the operation for showing slides of presentation documents created using the PC Card Viewer function with the projector.

It is also possible to make slides directly from the images projected with the projector.

Projecting slides

1. Insert a CompactFlash card into the card slot.
Insert the CompactFlash card with the side with the insertion direction arrow on the top.
* Press the eject button to eject the card.
2. Select the "PC Card Viewer" from the Source Select menu.

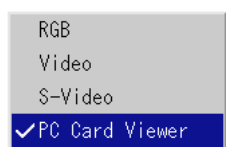

3. Project slides.

Checking "Show Folder List", means that selecting PC Card Viewer input displays a list of the folders in the CompactFlash card and if "Auto Play" is checked the projector automatically starts to play slides at the first slide of the folder you have selected.

A tool bar will appear when you press the MENU button on the remote control or the projector cabinet or clicking with the right button of a mouse.

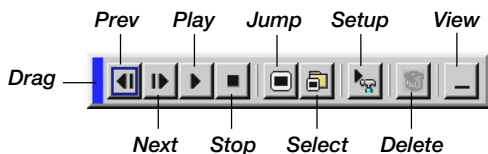

The tool bar includes the following buttons:

- Drag Drags to move the tool bar (for USB mouse operation only).
- Prev Returns to the previous slide or folder. Or this lets you play slides back in reverse.
- Next Advances to the next slide or folder. Or this lets you play slides back.
- Play Plays back automatically or manually depending on the setting on PC Card Viewer Options of the menu. This allows you to move on to the next slide when "Manual Play" is selected.
- Stop This allows you to stop Auto Play while you are playing back and to resume playing from the selected slide or folder when "Auto Play" is selected.
- Jump Displays a list of slides while you are playing back.
- Select Displays a list of folders while you are playing back.
- Setup Displays the PC Card Viewer Options dialog box on Page 2 of the Setup dialog box.

- Delete Deletes a captured slide(s) or all the captured slides in the Capture – specific folder.
- View Hides the tool bar while you are playing back. Pressing the MENU button or clicking with the right button of a mouse shows it again.

NOTE: If no CompactFlash card is inserted in the PC CARD slot, there is no signal, and a black, blue or logo background is displayed, depending on the setting.

Playback is stopped when SLIDE +/- on the remote control or ◀ / ▶ button on the cabinet is pressed in Auto Play mode.

NOTE: Up to 12 indexes can be displayed on the list of folders. The folder in the right bottom is always a folder exclusively for captured images, but is only displayed when images have been captured. To display the list of folders when there are 13 or more indexes stored on the CompactFlash card, select "Edit index" from the PC Card Viewer software's "File" menu and move the index you want to display to within 12 indexes from the top of the folder index. For details on indexes, refer to the PC Card Viewer software's help folder.

When the tool bar is not displayed:

Press the FOLDER LIST button on the remote control to display folders from a CompactFlash card in the projector's PC Card slot.

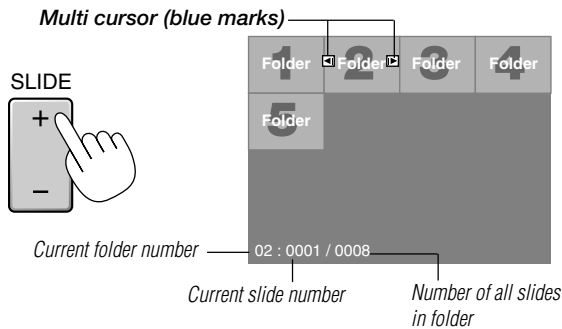

Use the SLIDE +/- button to advance to the next folder or return to the previous folder.



Slide(Table) cursor (green marks)

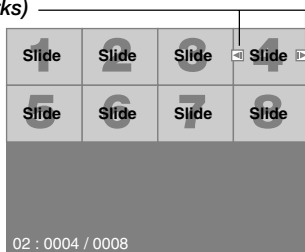

Use the SLIDE +/- button to advance to the next slide or return to the previous slide.



NOTE: You can also use the ◀ and ▶ button on the remote control to select folders or slides.

If you use the ◀ and ▶ button on the remote control for PC Card Viewer operation, press the PJ button to switch to the Projector mode and the PJ button lights red.

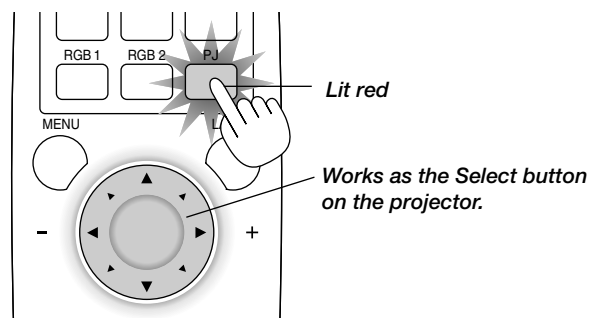

Auto Play Mode

- If the "Auto Play" option is selected in "PC Card Viewer Options" of the menu, any given slide will start to play automatically. You can also specify Auto Play Interval between 5 and 300 seconds.

Switching to Slides Directly from Other Input Modes

With this function it is possible to switch directly to a slide when the picture of a VCR or computer is being projected.

Example:

When conducting presentations using a combination of slides and moving pictures from a VCR, etc., it is possible to switch from a PC Card Viewer slide to the video picture then back to the PC Card Viewer slide simply by using a source button and PC CARD button.

NOTE: Even if you switch the current PC Card Viewer source to another source, the current slide is retained. When you return back to the PC Card Viewer, you will get the slide that has been retained.

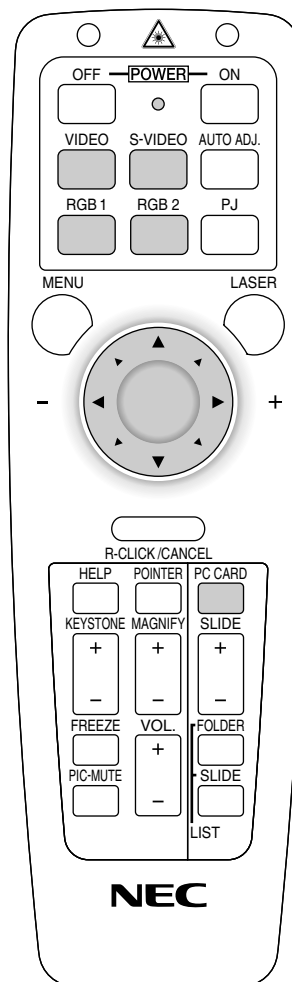

NOTE: The CompactFlash card editing operation cannot be performed from the projector. Do so using the PC Card Viewer software.

Capturing Images Displayed on the Projector

Storing images displayed on the projector on the CompactFlash card

Preparations:

Insert the CompactFlash card into the card slot.

Insert the CompactFlash card with the side with the insertion direction arrow on the top.

* Press the eject button to eject the card.

1. Project the image you wish to store on the projector.
2. Select the "Capture" from the Tools menu.

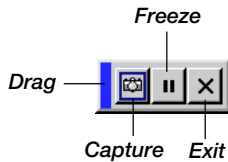
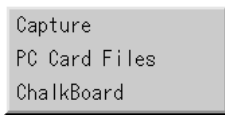

3. A tool bar will appear.

The tool bar includes the following buttons:

- Drag Drags to move the tool bar (for USB mouse operation only).
- Capture Captures an image and save it as a JPEG file in a CompactFlash card.
- Freeze Freezes and unfreezes images.
- Exit Exits the Capture function. Another option to exit the Capture function is to press MENU or CANCEL button on the remote control or projector cabinet.

NOTE: You can compress a captured file (JPEG) using the Capture Options in the Setup dialog. See page E-37.

NOTE: Captured images with higher resolution than the projector's native resolution cannot be displayed correctly.

NOTE:

- File size of the captured image varies depending on the resolution of an input signal.
- Since an image data is compressed with the JPEG format, the image is slightly degraded.

NOTE: An hourglass indicating that an image is being captured appears on the projector's display. Do not eject the CompactFlash card or turn off the projector's power while this icon is displayed. Doing so will damage the CompactFlash card data. If the CompactFlash card data is damaged, use a computer to repair the data.

NOTE: The folder in the right bottom is always a folder exclusively for captured images. To display the list of folders when there are 13 or more indexes stored on the CompactFlash card, select "Edit index" from the PC Card Viewer software's "File" menu and move the index you want to display to within 12 indexes from the top of the folder index. For details on indexes, refer to the PC Card Viewer software's help file.

Deleting Captured Images

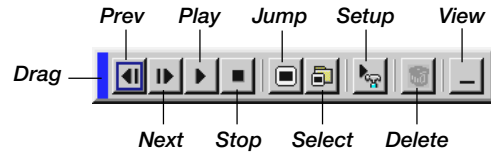

Using the Delete button on the tool bar for PC Card Viewer can delete captured images.

To delete captured images:

1. Select PC Card Viewer.
2. Use ► button to select the Capture folder in the right bottom of the screen.
3. Press the MENU button to display the tool bar.
4. Use the ◀ or ▶ button to select the Delete icon and press the ENTER button or click with a mouse button.

Viewing Digital Images

Digital images can be played with the PC Card Viewer if the following conditions are met:

- If the image can be stored on an MS-DOS format CompactFlash card
- If the image can be stored in a format supported by the PC Card Viewer. With the PC Card Viewer, images on the card are searched for in directories and images in JPEG or BMP format are recognized as slides. Searchable directories are directories within two steps from the root directory, and searchable images are images within the first 12 files in the directory. Only file and slide switching are possible.

NOTE: The maximum number of images recognized as slides within one directory is 128.

Uninstalling the PC Card Viewer Software

Even if you do not know the PC Card Viewer software's file names or where they are stored, the PC Card Viewer software files can be easily removed from the system using the "Install/Uninstall Applications" control panel in Windows. (Normally there is no need to perform this operation.)

Uninstalling the software

Use the procedure described below to uninstall the PC Card Viewer software files.

1. From the "Start" menu, select "Settings" then "Control Panel".

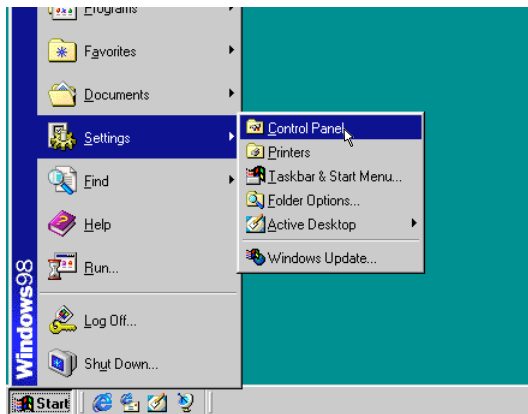

2. In the "Control Panel" dialog box, double-click on "Add/Remove Programs".

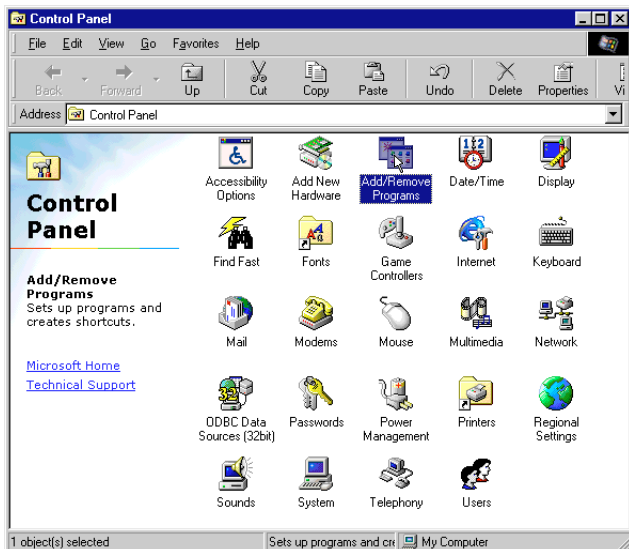

3. In the "Add/Remove Programs Properties" dialog box, click the "Install/Uninstall" tab, then select "PC Card Viewer Utility 1.0" from the list of applications and click on "Add/Remove".

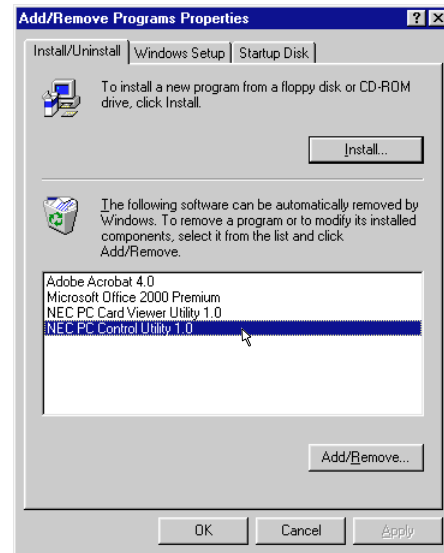

4. In the "Confirm File Deletion" dialog box, click "Yes".

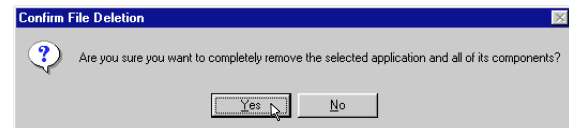

5. Once the application is uninstalled, click on "OK" in the "Remove Program From Your Computer" dialog box.

Terminology

PC card	This is the name of a card currently being standardized by the Japan Electronic Industry Association (JEIDA) and PCMCIA (Personal Computer Memory Card Interface Association) of the United States.
ATA card	A type of PC card. ATA was originally a type of interface between computers and fixed disk devices. The ATA card is a standard card-type recording medium.
CompactFlash	CompactFlash card is a small removable card conforming to ATA specifications. It is one-fourth the volume of a PCMCIA card.
TYPE (I, II and III)	PCMCIA 2.1 PC cards are divided into three types according to their thickness: Type I (3.3 mm), Type II (5.0 mm) and Type III (10.5 mm).
BMP	A type of image format. The standard Windows Bit Map format used for MS-DOS/Windows-compatible computers.
JPEG	A type of image format. "JPEG" is the abbreviation of Joint Photographic Experts Group. JPEG compression offers efficient data storage. The data not required for displaying the image is identified and deleted. Since the data is deleted, JPEG algorithms are said to be irreversible. This means that once the image is compressed, the decompressed image it is not the same as the original image.

4. MAINTENANCE

This section describes the simple maintenance procedures you should follow to replace the lamp and clean the filter.

Replacing the Lamp

After your lamp has been operating for 1000 hours (2000 hours : Eco mode) or longer, the "Status" light in the cabinet will go on and the message will appear. Even though the lamp may still be working, replace it at 1000 (2000 hours : Eco mode) hours to maintain optimal projector performance.

CAUTION

- DO NOT TOUCH THE LAMP immediately after it has been used. It will be extremely hot. Turn the projector off, wait a full minute, and then disconnect the power cable. Allow at least one hour for the lamp to cool before handling.
- DO NOT REMOVE ANY SCREWS except the lamp cover screw and two lamp housing screws. You could receive an electric shock.
- The projector will turn off and go into stand by mode after 1100 (2200 hours : Eco mode) hours of service. If this happens, be sure to replace the lamp. If you continue to use the lamp after 1000 hours (2000 hours : Eco mode) of use, the lamp bulb may shatter, and pieces of glass may be scattered in the lamp housing. Do not touch them as the pieces of glass may cause injury. If this happens, contact your NEC dealer for lamp replacement.

To replace the lamp:

1. Loosen the lamp cover screw until the screwdriver goes into a freewheeling condition and remove the lamp cover. The lamp cover screw is not removable.

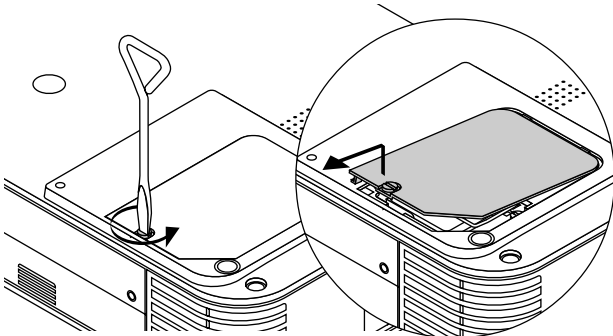

2. Loosen the two screws securing the lamp housing until the screwdriver goes into a freewheeling condition. The two screws are not removable.

Remove the lamp housing by pulling out the handle.

NOTE: There is an interlock on this case to prevent the risk of electrical shock. Do not attempt to circumvent this interlock.

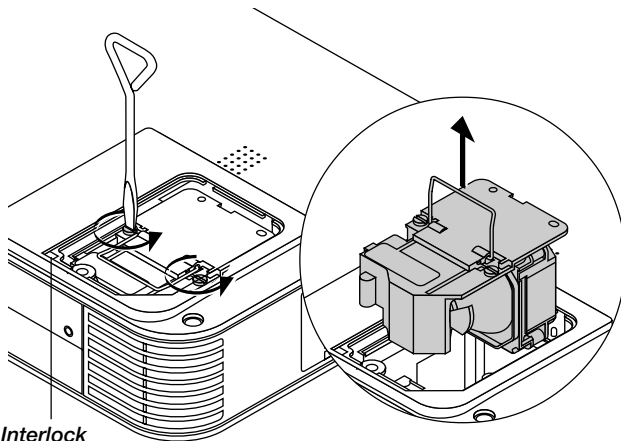

3. Insert a new lamp housing until the lamp housing is plugged into the socket.

CAUTION: Do not use a lamp other than the NEC replacement lamp (LT55LP). Order this from your NEC dealer.

Secure it in place with the two screws.

Be sure to tighten the screws.

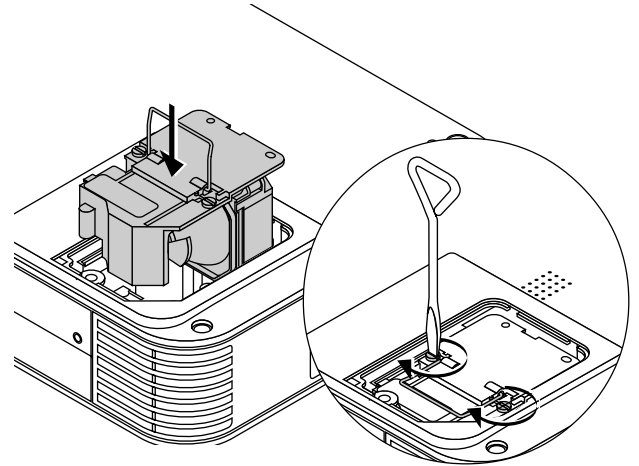

4. Reattach the lamp cover.

Tighten the lamp cover screw.

Be sure to tighten the screw.

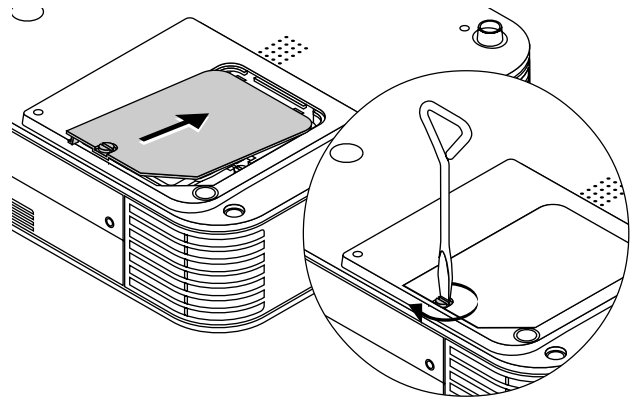

5. After you install a new lamp, select [Menu] → [Projector Options] → [Setup] → [Page 4] → [Clear Lamp Hour Meter] to reset the lamp usage hours.

NOTE: When the lamp exceeds 1100 hours (2200 hours : Eco mode) of service, the projector cannot turn on and the message is not displayed. If this happens, press the Help button on the remote control for a minimum of 10 seconds while in standby mode. When the lamp time clock is reset to zero, the STATUS indicator goes out.

Cleaning or Replacing the Filters

The air-filter sponge keeps the inside of the MultiSync LT156/LT155/LT154 Projector free from dust or dirt and should be cleaned after every 100 hours of operation (more often in dusty conditions). If the filter is dirty or clogged, your projector may overheat.

CAUTION

- Turn off the power and unplug the projector before replacing the filter.
- Only clean the outside of the filter cover with a vacuum cleaner.
- Do not attempt to operate the projector without a filter cover.
- Your projector will not operate unless the filter cover is installed correctly.

To clean the air-filter:

Vacuum the filter-through the filter cover.

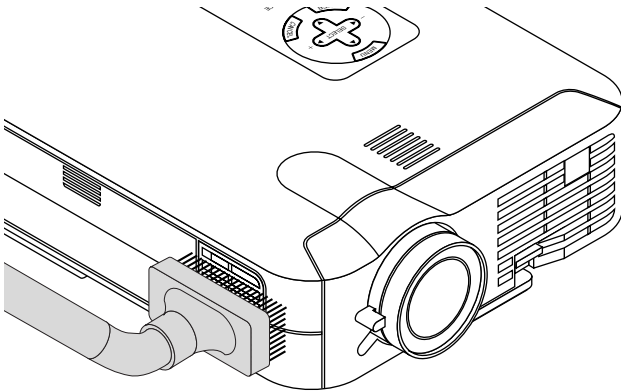

To replace the air-filter:

1. Remove the filter cover by pushing down on the catch of the cover until you feel it detach.

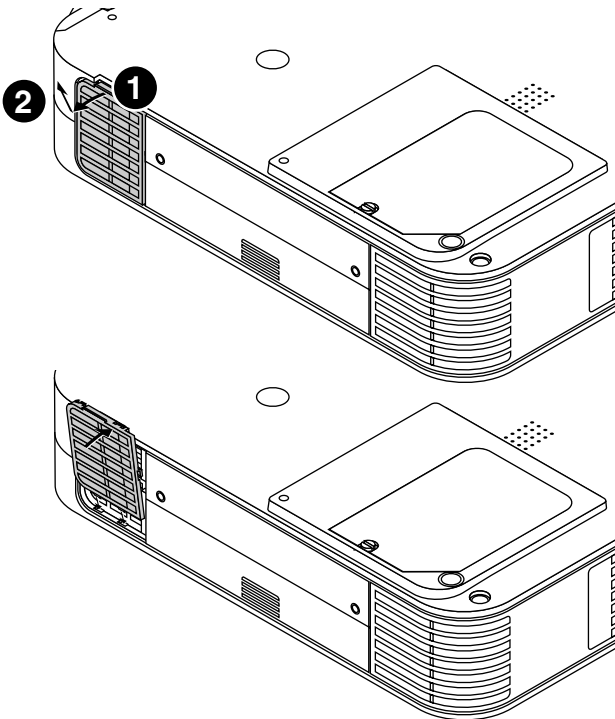

2. Reinstall the new filter cover.

NOTE: Do not detach the sponge from the filter cover. Do not wash the filter cover with soap and water. Soap and water will damage the the filter membrane. Before replacing the filter cover, remove dust and dirt from the projector cabinet. Keep out dust and during filter replacement.

5. TROUBLESHOOTING

This section helps you resolve problems you may encounter while setting up or using the projector.

Power/ Status Light Messages

Condition	Power Indicator	Status Indicator	Note
Standby	Steady orange	–	–
Cooling down	Blinking green	–	Blinks green for 60 seconds
Lamp in High-Bright mode	Steady green	–	–
Lamp in Eco mode	Steady green	Steady green	–
Retrying to turn on lamp	Steady green	Blinking orange	The projector retries 3 times at an interval of 15 sec for max. 45 sec)
One minute after lamp is turned on	Blinking green	No light in High-Bright mode Blinking green in Eco mode	–
3 minutes after lamp is turned on in Eco mode	Steady green	Blinking green	Fixed at High-Bright mode. Lamp mode can be changed on the menu
Lamp has reached its end of life (1000 hours or over)	Steady green	Steady red (High-Bright mode)/ Steady orange (Eco mode)	Message appears on screen during 1000-1100 hours of lamp usage. The projector reaches its end of life. Please replace the lamp as soon as possible
Lamp life has reached its end of life (1100 hours or over)	Steady orange	Steady red	The projector is in standby mode and cannot be turned on.
Lamp or filter cover error (2 locations)	Steady orange	Blinking red (1 sec interval)	The projector is in standby mode and cannot be turned on.
Fan error	Steady orange	Blinking red (8 sec interval)	The projector is in standby mode and cannot be turned on.
Lamp error	Steady orange	Blinking red (12 sec interval)	The projector is in standby mode and cannot be turned on.
Temperature error	Steady orange	Blinking red (4 sec interval)	The projector is in standby mode and cannot be turned on.

Common Problems & Solutions

Problem	Check These Items
Does not turn on	<ul style="list-style-type: none"> • Check that the power cable is plugged in and that the power button on the projector cabinet or the remote control is on. • Ensure that the lamp cover or filter cover is installed correctly. See page E-48 and 49. • Check to see if the projector has overheated or the lamp usage exceeds 1100 hours (2200 hours in Eco mode). If there is insufficient ventilation around the projector or if the room where you're presenting is particularly warm, move the projector to a cooler location.
No picture	<ul style="list-style-type: none"> • Use the menu to select your source (Video, S-Video, RGB (DVI digital or DVI analog on LT156) or PC Card Viewer). See page E-33. • Ensure your cables are connected properly. • Use menus to adjust the brightness and contrast. See page E-33. • Remove the lens cap. • Reset the settings or adjustments to factory preset levels using the Factory Default on the Image Options Menu in Advanced menu. See page E-36.
Image isn't square to the screen	<ul style="list-style-type: none"> • Reposition the projector to improve its angle to the screen. See page E-25. • Use the Keystone to correct the trapezoid distortion. See page E-29 or 34.
Picture is blurred	<ul style="list-style-type: none"> • Adjust the focus. See page E-25. • Reposition the projector to improve its angle to the screen. See page E-25. • Ensure that the distance between the projector and screen is within the adjustment range of the lens. See page E-16.
Image is scrolling vertically, horizontally or both	<ul style="list-style-type: none"> • Use menus or a source button on the remote control or the cabinet to select the source you want to input.
Remote control does not work	<ul style="list-style-type: none"> • Install new batteries. See page E-13. • Make sure there are no obstacles between you and the projector. • Stand within 22 feet (7 m) of the projector. See page E-13. • Make sure that you are in the Projector mode or the PJ button lights in red. If not, press the PJ button.
Status indicator is lit or blinking	<ul style="list-style-type: none"> • See the Power/ Status Light messages above.
Cross color in RGB mode	<ul style="list-style-type: none"> • If Auto Adjust is off, turn it on. If Auto Adjust is on, turn it off and balance the image with the Position and Clock Adjust on the Advanced Options Menu. See page E-35.

When using the PC Card Viewer function

Condition	Status
No picture	<ul style="list-style-type: none">• Is "PC Card Viewer" selected from the Source menu?• Is the CompactFlash card seated in the PC CARD slot completely?• Are slide data stored in the CompactFlash card?• Have the contents of the CompactFlash card been destroyed?
Part of a slide is not displayed	<ul style="list-style-type: none">• While an image with over 1024×768 dots is projected, several lines of information will be lost. Use the supplied software change the image to 1024×768 dots in size.
Contents of CompactFlash Card are damaged	<ul style="list-style-type: none">• Use a computer, etc., to repair the data.

For more information contact your dealer.

6. SPECIFICATIONS

This section provides technical information about the MultiSync LT156/LT155/LT154 Projector's performance.

Model Number **LT156/LT155/LT154**

Optical

LCD Panel	0.9" p-Si TFT active-matrix, 1024×768 dots With Micro Lens Array (LT156 / LT155)
Lens	Manual zoom, manual focus F2.0 – 2.3 f=36.5 – 42 mm
Lamp	130W NSH lamp (110W in Eco mode) The lamp, under normal operating conditions, is warranted for 1000 hours of operation time within 6 months.
Image Size	25 – 300 inches (0.64 – 7.62 m) diagonal
Projection Distance	3.7 – 40.1 ft (1.1 - 12.2 m)

Electrical

Inputs	Video (NTSC / PAL / PAL-N* / PAL-M* / PAL60 / SECAM / NTSC4.43) Horizontal Frequency : 15 – 100 kHz (RGB : 24 kHz or over) Vertical Frequency : 50 – 120 Hz DVI 29 pin* : RGB digital (Max resolution: XGA), TMDS specification (functions as DVI analog input)
Video Bandwidth	RGB: 80 MHz
Color	Reproduction Full color, 16.7 million colors simultaneously.
Horizontal Resolution	500 TV lines : NTSC / PAL / NTSC4.43 / YCbCr (550 TV lines : LT156 only) 350 TV lines : SECAM RGB 1024 dots horizontal, 768 dots vertical
Power Requirement	100 – 120 / 200 – 240 VAC, 50 / 60 Hz
Input Current	2.2 A (100 – 120 VAC) / 1.0A (200 – 240 VAC)

Mechanical

Dimensions	8.1" (W)×2.5" (H)×10.5" (D) / 207mm (W)×63mm (H)×266mm (D) (not including lens and feet)
Net Weight	4.9 lbs / 2.2 kg
Environmental Considerations	Operational Temperatures: 32° – 95°F (0° to 35°C), 20 – 80% humidity (non-condensing) Storage Temperatures: 14° – 122°F (-10° to 50°C), 20 – 80% humidity (non-condensing)
Regulations	UL Approved (UL 1950, CSA 950) Meets DOC Canada Class B requirements Meets FCC Class B requirements Meets AS/NZS3548 Class B Meets EMC Directive (EN55022, EN55024, EN61000-3-2, EN61000-3-3) Meets Low Voltage Directive (EN60950, TUV GS Approved)



* LT156 only

LCD panels are inherently susceptible to bad pixels.
The LCD panel may have pixel failures at the rate of 0.01% or less.

We provide information about our projectors through the World Wide Web at <http://www.nec-pj.com/>

The specifications are subject to change without notice.

Cabinet Dimensions

LT156/LT155/LT154

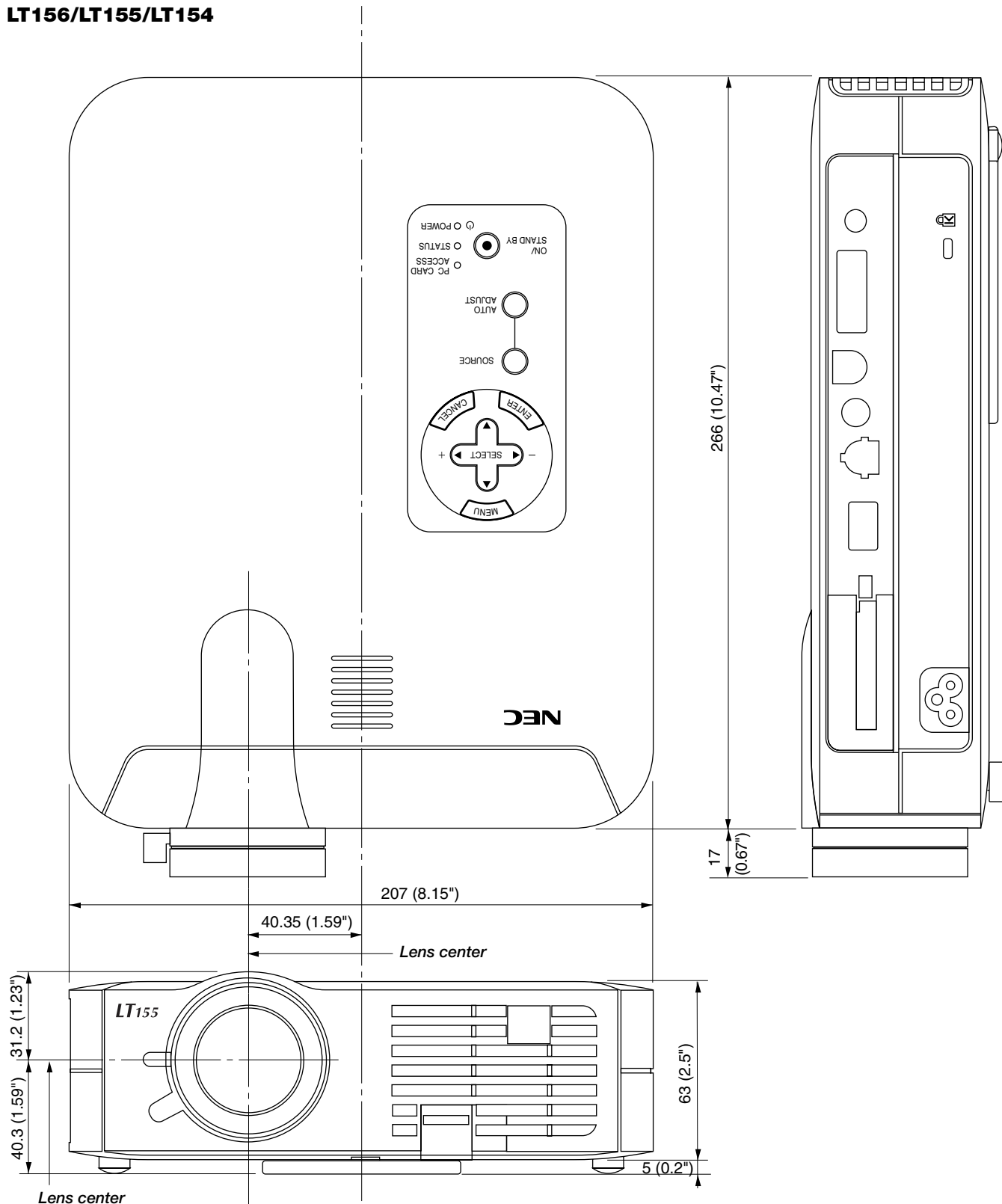

Unit = mm (inch)

D-Sub Pin Assignments

Mini D-Sub 15 Pin Connector

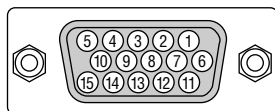

Signal Level
 Video signal : 0.7Vp-p (Analog)
 Sync signal : TTL level

Pin No.	RGB Signal (Analog)	YCbCr Signal
1	Red	Cr
2	Green or Sync on Green	Y
3	Blue	Cb
4	Ground	
5	Ground	
6	Red Ground	Cr Ground
7	Green Ground	Y Ground
8	Blue Ground	Cb Ground
9	No Connection	
10	Sync Signal Ground	
11	Ground	
12	Bi-directional DATA (SDA)	
13	Horizontal Sync or Composite Sync	
14	Vertical Sync	
15	Data Clock	

Timing Chart

Y / N	Signal	Resolution (Dots)	Frequency H. (kHz)	Refresh Rate (Hz)	Dot Clock (MHz)
Y	NTSC	640 × 480	15.734	60	-
Y	PAL	768 × 576	15.625	50	-
Y	SECAM	768 × 576	15.625	50	-
Y	VESA	640 × 480	31.47	59.94	25.175
Y	IBM	640 × 480	31.47	60	25.175
Y	MAC	640 × 480	31.47	60	25.175
Y	MAC	640 × 480	34.97	66.67	31.334
Y	MAC	640 × 480	35	66.67	30.24
Y	VESA	640 × 480	37.86	72.81	31.5
Y	VESA	640 × 480	37.5	75	31.5
Y	IBM	640 × 480	39.375	75	31.49
Y	VESA	640 × 480	43.269	85.01	36
Y	IBM	720 × 350	31.469	70.09	28.322
Y	VESA	720 × 400	37.927	85.04	40
Y	IBM	720 × 350	39.44	87.85	35.5
Y	IBM	720 × 400	39.44	87.85	35.5
Y	VESA	800 × 600	35.16	56.25	36
Y	VESA	800 × 600	37.879	60.32	40
Y	VESA	800 × 600	48.077	72.19	50
Y	VESA	800 × 600	46.88	75	49.5
Y	VESA	800 × 600	53.674	85.06	56.25
Y	MAC	832 × 624	49.725	74.55	57.283
Y	VESA	1024 × 768	35.5	43 Interlaced	44.9
Y	VESA	1024 × 768	48.363	60	65
Y	VESA	1024 × 768	57.476	70.07	75
Y	MAC	1024 × 768	60.241	74.93	80
Y	VESA	1024 × 768	60.023	75.03	78.75
Y	VESA	1024 × 768	68.677	85	94.5
#Y	VESA	1152 × 864	67.5	75	108
#Y	MAC	1152 × 870	68.681	75.6	100
#Y	SUN	1152 × 900	61.796	65.95	92.94
#Y	SGI	1152 × 900	71.736	76.05	105.6
#Y	VESA	1280 × 960	60	60	108
#Y	SGI	1280 × 1024	63.9	60	107.35
#Y	VESA	1280 × 1024	64.286	60.02	108
#Y	MAC	1280 × 1024	64.31	60.38	107
#Y	MAC	1280 × 1024	69.89	65.2	118.5
#Y	HP	1280 × 1024	78.125	72.01	135
#Y	SUN	1280 × 1024	81.13	76.11	135
#Y	VESA	1280 × 1024	79.976	75.03	135
#Y	VESA	1280 × 1024	91.146	85.02	157.5
#Y	HDTV (1080i)(1125i)	1920 × 1080	33.75	60 Interlace	74.25
#Y	HDTV (720p)(750p)	1280 × 720	45	60 Progressive	74.25
#Y	SDTV (480p)(525p)	-	31.47	59.94 Progressive	27
#Y	SDTV (480i)(525i)	-	15.73	59.9 Interlace	-
#Y	VESA	1600 × 1200	75.0	60	162
#Y	VESA	1600 × 1200	81.3	65	175.5
#Y	VESA	1600 × 1200	87.5	70	189
#Y	VESA	1600 × 1200	93.75	75	202.5
Y	DVD YCbCr	-	15.734	59.94 Interlaced	-
Y	DVD YCbCr	-	15.625	50 Interlaced	-

#Y: Images in above flagged with # and Y are compressed with Advanced AccuBlend.

NOTE1: Some composite sync signals may not be displayed correctly.

NOTE2: Signals other than those specified in the table above may not be displayed correctly. If this should happen, change the refresh rate or resolution on your PC. Refer to Display Properties help section of your PC for procedures.

NOTE3: UXGA can be supported for separate sync signal only.

NOTE4: DVI digital signal can support a maximum resolution of XGA@85Hz.

PC Control Codes

LT155/LT154

Function	Code Data
POWER ON	02H 00H 00H 00H 00H 02H
POWER OFF	02H 01H 00H 00H 00H 03H
INPUT SELECT RGB	02H 03H 00H 00H 02H 01H 01H 09H
INPUT SELECT VIDEO	02H 03H 00H 00H 02H 01H 06H 0EH
INPUT SELECT S-VIDEO	02H 03H 00H 00H 02H 01H 0BH 13H
INPUT SELECT PC CARD VIEWER	02H 03H 00H 00H 02H 01H 1FH 27H
PICTURE MUTE ON	02H 10H 00H 00H 00H 12H
PICTURE MUTE OFF	02H 11H 00H 00H 00H 13H
SOUND MUTE ON	02H 12H 00H 00H 00H 14H
SOUND MUTE OFF	02H 13H 00H 00H 00H 15H
ON SCREEN MUTE ON	02H 14H 00H 00H 00H 16H
ON SCREEN MUTE OFF	02H 15H 00H 00H 00H 17H

LT156

Function	Code Data
POWER ON	02H 00H 00H 00H 00H 02H
POWER OFF	02H 01H 00H 00H 00H 03H
INPUT SELECT DVI (DIGITAL)	02H 03H 00H 00H 02H 01H 1AH 22H
INPUT SELECT DVI (ANALOG)	02H 03H 00H 00H 02H 01H 01H 09H
INPUT SELECT VIDEO	02H 03H 00H 00H 02H 01H 06H 0EH
INPUT SELECT S-VIDEO	02H 03H 00H 00H 02H 01H 0BH 13H
INPUT SELECT PC CARD VIEWER	02H 03H 00H 00H 02H 01H 1FH 27H
PICTURE MUTE ON	02H 10H 00H 00H 00H 12H
PICTURE MUTE OFF	02H 11H 00H 00H 00H 13H
SOUND MUTE ON	02H 12H 00H 00H 00H 14H
SOUND MUTE OFF	02H 13H 00H 00H 00H 15H
ON SCREEN MUTE ON	02H 14H 00H 00H 00H 16H
ON SCREEN MUTE OFF	02H 15H 00H 00H 00H 17H

NOTE: Contact your local dealer for a full list of the PC Control Codes if needed.

Cable Connection

Communication Protocol

Baud rate: 38400 bps
 Data length: 8 bits
 Parity: No parity
 Stop bit: One bit
 X on/off: None
 Communications procedure: Full duplex

PC Control Connector (DIN-8P)

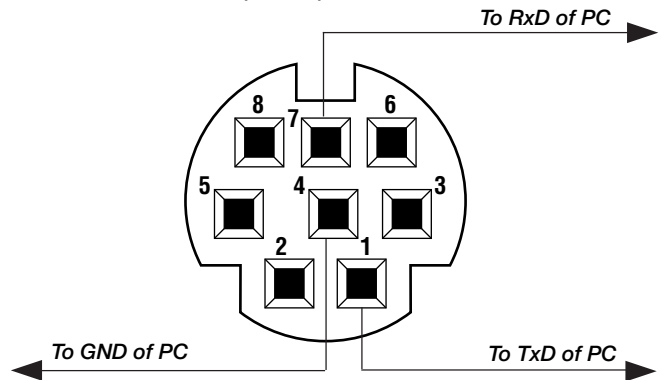

NOTE: Pins 2, 3, 5, 6 and 8 are used inside the projector.

NEC