

IKASU™



DB060883
HIFI/DVD Player

Table of Contents.....	1
Safety and Upkeep.....	2
Functions	3
Accessories.....	4
Remote Control	5
Instructions	6-20
Specifications	21
Trouble Shooting	22
Technical Support.....	23

Please read all the warnings given and those marked on the unit. This unit has been designed and manufactured to assure personal safety.

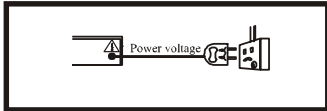

Only use the power plug supplied
With the unit

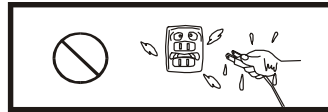

Keep unit and power plug
away from water!



Avoid direct sunlight and
close heat source.

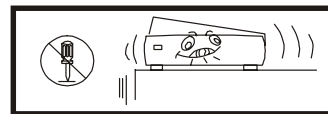

Never open the cover, avoid metals
dropping in, like needles, hairpin,
coin, etc.

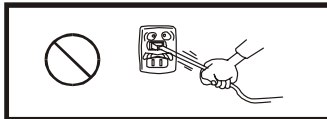

Do not pull and bend the power
cable excessively.

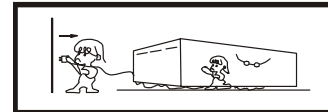

Unplug the set from the outlet when
not in use for long periods of time

- FM radio receiver
- Illuminated Colour LED display
- Full function infrared remote control
- Audio supported – CD/DVD/VCD/MP3/MP4
- Video Supported – DVD/MPEG2/MPEG1
- Chromatic aberration output, S-Video output, Stereo, Video output, Optical Fiber output, Coaxial output and Scart output

ACCESSORIES

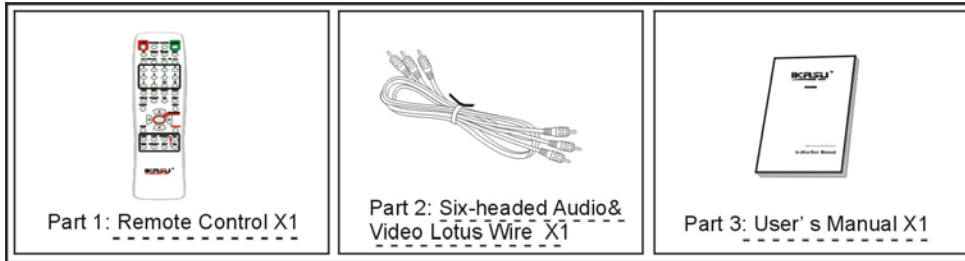

REMOTE CONTROL

NOTE:

The distance of remote control should not exceed 7 meters otherwise it will not work
 Battery Size: 2x AAA Standard Voltage: 1.5V

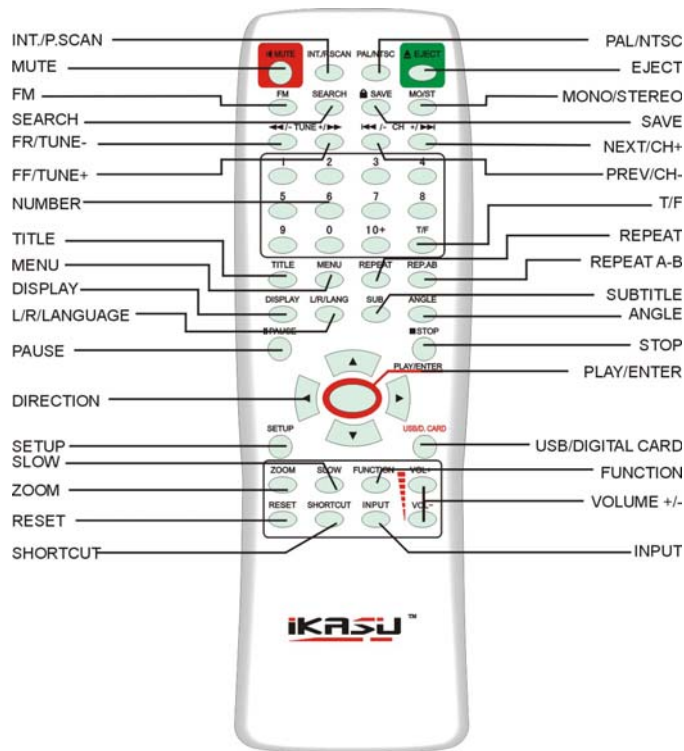

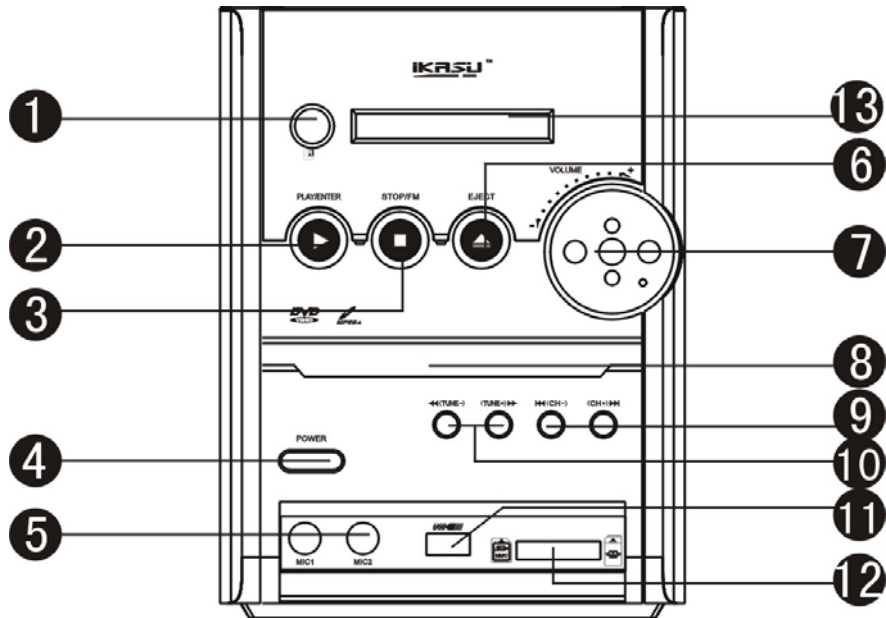

- 1. REMOTE CONTROL SENSOR
- 2. PLAY/ENTER
- 3. STOP/FM
- 4. POWER
- 5. MIC. SOCKETS
- 6. EJECT
- 7. VOLUME+/-

- 8. DISC DOOR
- 9. PREVIOUS/NEXT/(CH-/+)
- 10. FR/FF/(TUNE-/+)
- 11. USB PORT
- 12. MULTI-MEDIA CARD PORT
- 13. DISPLAY SCREEN

BACK PANEL

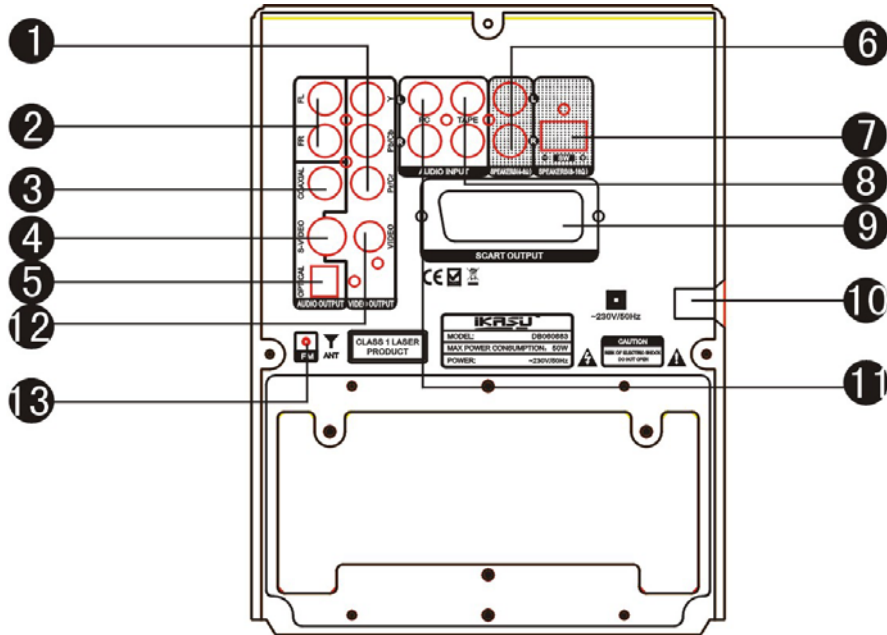

1. Y, Pb/Cb, Pr/Cr COMPONENT OUTPUT
2. L/R FRONT AUDIO OUTPUT
3. COAXIAL OUTPUT
4. S-VIDEO OUTPUT
5. OPTICAL FIBER OUTPUT
6. L/R SPEAKERS OUTPUT
7. SUBWOOFER OUTPUT
8. L/R TAPE AUDIO OUTPUT
9. SCART OUTPUT
10. POWER SUPPLY INPUT
11. L/R PC AUDIO INPUT
12. VIDEO OUTPUT
13. FM ANTENNA INTERFACE

CONNECTING TO YOUR TV

1. If your TV has a AV terminal, connect this unit to the TV with A/V cables, and set your TV to AV status after confirming the connection is correct. (Figure 1)
2. If your TV has a S-Video terminal, please use the S-Video connection cable to connect the player and TV, to obtain a higher quality image. (Figure 2)
3. If your TV has a chromatics output terminal, please use three connection cables to connect the player and TV, to obtain a more vivid image. (Figure 3)
4. This unit has an output interface for SCART output, which can directly be connected with TV. (Figure 4)

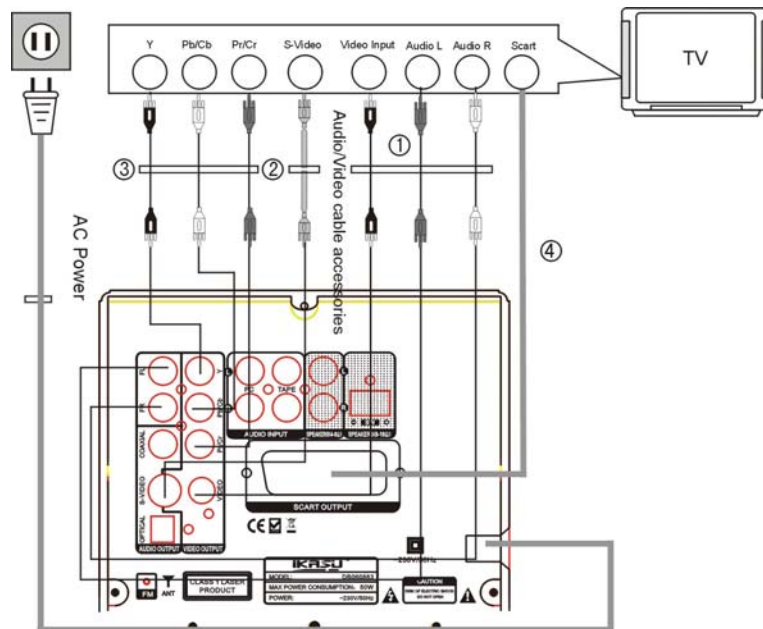

Note:

1. You must turn off the switch of both the player and the TV before they are connected and unplug the power line from the socket.
2. You may adjust the corresponding system according to your TV system while watching various discs.
3. If there are multiple connections between your video player and TV, please select one and unplug others so as not to affect the quality of the images and sound.
4. Do not connect the digital optical or coaxial output jack of this player with the analogue signal input terminal for reception.

CONNECTING WITH AN AMPLIFIER

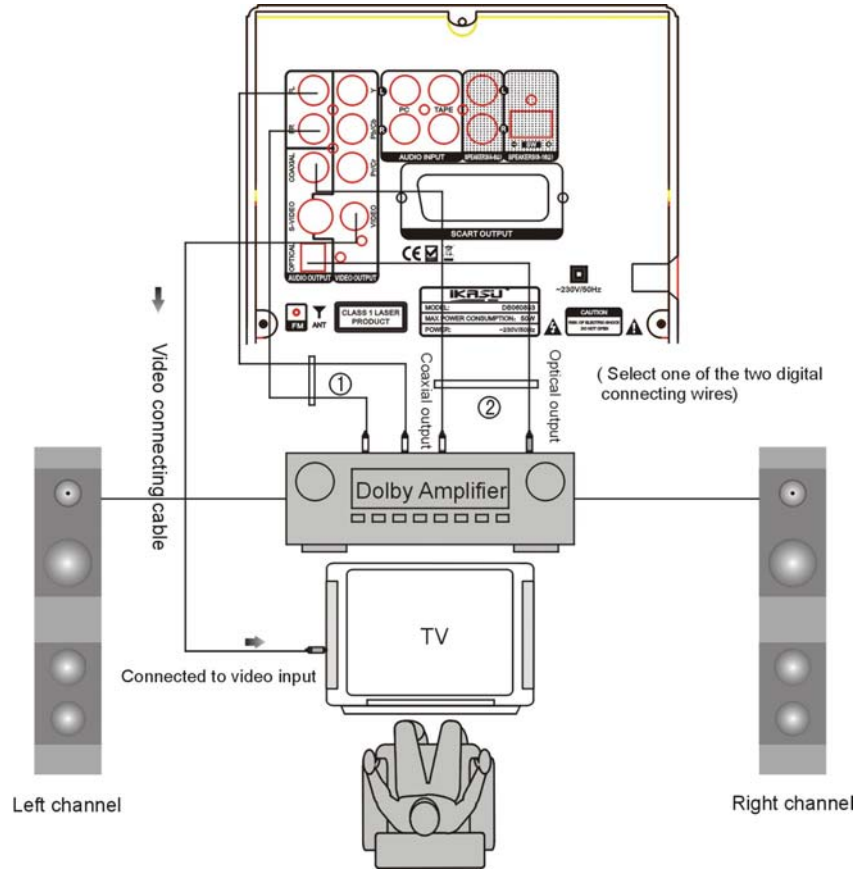

Setup of Digital Audio Output

Connect the optical or coaxial output jack to the amplifier. While in play or stop mode, press the setup button on the remote control to open the system setup page, switch to audio setup page by pressing the directional buttons, then move the cursor to Audio Out, select SPDIF/RAW or SPDIF/PCM, press Play/Enter button to finish. Press setup button again to exit the setup.

SYSTEM CONNECTION

Please refer to the following figure to connect your acoustic equipment!

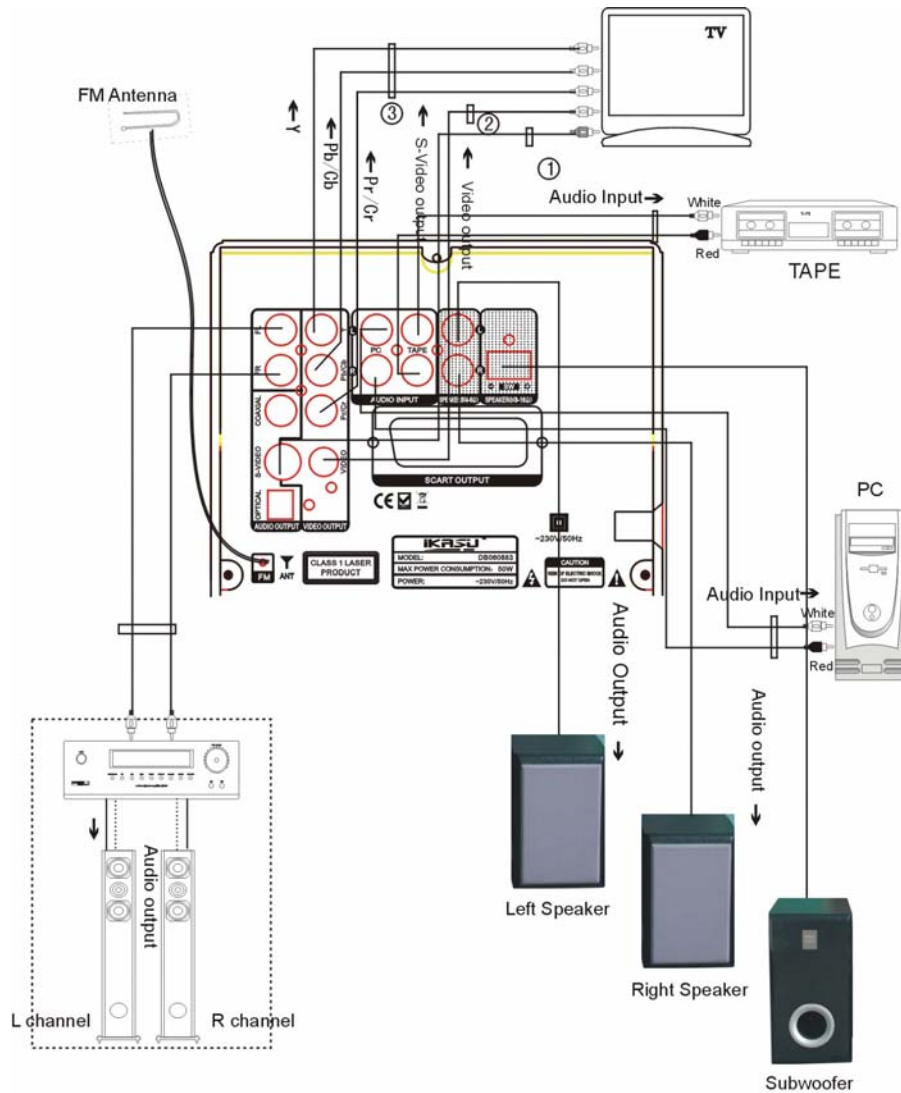

BASIC OPERATION

SWITCHING ON

- 1). Before turning on, check whether all the connections are correct and reliable. Plug the power plug into the corresponding power socket.
- 2). Press the Power button on the front panel to turn on.
- 3). Press the Eject button on the remote control or panel to open the disc tray, put the disc into the tray, press Eject button again, the unit will start to read and play.

MUTE

In play status, If the Mute button is pressed, there will be no audio output, the sound is eliminated, however the image will still be played normally. Then press the button again or press Vol.+/- button to exit the mute status, the sound resumes to be its normal status.

STATUS DISPLAY

In play status, press Display button, the TV screen will display the following data:

VCD display: Disc Type, Soundtrack and Gross Track, Mute ON/OFF, Menu ON/OFF, Repeat ON/OFF, Song Time.

DVD display: Disc Type, Chapter for play, Song Time, Language Channel Mode, Screen Picture Proportion, Angle Status.

SOUNDTRACK SWITCH

When playing VCD, DVCD's, press L/R/LANG button to select the multiple output modes such as Mono L, Mono R, Stereo, etc. Press the button once to switch soundtrack.

When playing DVD's, pressing the L/R/LANG button will select multiple languages for playback. (Only applies to the discs like DVD recorded in multiple languages.)

FAST FORWARD & FAST BACKWARD

In play status, press Tune-◀◀ button or Tune+▶▶, there will be various speeds of fast forward and fast backward, shown as follows,

FORWARD X 2, FORWARD X 4, FORWARD X 8, FORWARD X 20, PLAY

BACKWARD X 2, BACKWARD X 4, BACKWARD X 8, BACKWARD X 20, PLAY

PREVIOUS & NEXT

In play status, press CH- ◀◀ button, the device will skip to the previous one for play, press CH+ ▶▶ button, the device will skip to the next one.

SUBTITLE SELECTION

When the played DVD disc records multiple subtitles, you can make 7 selections of subtitles by pressing Subtitle button, they are:

English, German, French, Spanish, Portuguese, Dutch and Danish.

BASIC OPERATION

TIME SELECTION

In play mode, press **T/F** button on the remote control, the TV screen displays,

VCD Display: VCD TRK 01/XX  PBC  00:00:00

VCD Display: DVD TT 01/XX CH 007/XXX 00:00:00

You can press **◀ ▶** directional buttons to move the cursor to the time position, then input the corresponding numbers by pressing the numeric buttons, then press **Play/Enter** button to enter the desired part for playing. The optional time range depends on the volume of the played disc.

For example: Select 55 minutes 20 seconds, enter 0,0,5,5,2,0, press **Play/Enter**.

Select 90 minutes, enter 0,1,3,0,0,0, press **Play/Enter**.

REPEAT

In play status, repeatedly press **Repeat** button to select the different repeat types.

1). When in DVD mode, repeatedly press **Repeat** button, the TV screen will display:

OFF, CHAPTER, ALL.

2). When in CD, VCD, CD-R mode, press the repeat button repeatedly, the screen will display:

OFF, REP 1, REP ALL.

3). When in MP3, JPEG mode the options are: OFF, REP 1, REP DIR, REP ALL.

A-B REPEAT

A-B repeat allows you to repeat between two points which you select. In order to do this press the **REP.AB** button once to select the starting point, then press it again to select the end point. It will now repeatedly play in between the two selections. In order to turn this off press the button one more time. Note: This function only works for DVD's.

SYSTEM SWITCH

In any status, press the **PAL/NTSC** button on the remote control, the TV screen will be switched between PAL, AUTO, NTSC.

TITLE

If the played DVD disc contains a directory column, press the **Title** button to display the items contained in this disc. Use the direction buttons to move the cursor to select the items you want to play, or directly use the number button to select.

SHORTCUT

When playing DVD discs, press the Shortcut button to jump over the initial title, menu or warnings.
(Only for some discs, subject to the quality or recorded status of the played discs)

RESET

In any status, press the Reset button to return to the original setup or default value.

STOP

In play mode, press the Stop button, the TV screen will return to the startup screen, press Play/Enter button, the player will begin to play where it left off, here the TV screen will display "RESUME". In play status, successively press Stop button twice and then press Play/Enter button, the disc will be played from the beginning.

PAUSE

In play status, press Pause button, the player will pause, and press it again or press Play/Enter button once to continue playing.

MENU

Pressing the Menu button on the remote control opens or closes the PBC menu.

- Note: 1). It will go into the Root menu when playing DVD discs.
2). Older discs or some copies don't support this function.

ANGLE SELECTION

In play status, repeatedly press the Angle button, you can enjoy the same action shot in different angles. (The function depends on the discs and if its encoded)

VOLUME ADJUSTMENT

You can press the VOL-/+ button to turn up or down the volume of this unit.

DIRECTION BUTTONS

Press the direction buttons ▲ ▼ ◀ ▶ to move the cursor to select pictures or menu selections.

SLOW

In play status, every time the Slow button is pressed, the speed of the disc will play in 1/2, 1/3, 1/4, 1/5, 1/6, 1/7.

NUMBER BUTTONS

- 1). While playing songs, press the numeric buttons to directly select the songs you need.
- 2). If the desired track number is # 10 or above, you can select it by pressing the 10+ button once, and then pressing a numeric button (1--10). For example: If the 16th song is needed, you can press the 10+ button followed by the 6.

PROGRESSIVE SCAN/INTERLACE

Press the INT./P.SCAN button to switch between video output modes: INTERLACE-YUV, TV-RGB, P-SCAN YPBPR, S-VIDEO.

Note: If the TV image is poor, please first confirm the correspondence between DVD setup and TV scanning mode.

INPUT SELECTION

When you are connected to an external source like Tape or your PC, press the input button on your remote control to switch between the two modes.

FUNCTION

If you want to adjust the volume of Treble, Bass or Subwoofer. First press the Function button, select the corresponding item and press Vol+/- button on the remote control to increase or reduce the volume of Treble, Bass and Subwoofer.

ZOOM

In play status every time the Zoom button is pressed, the TV screen will be zoomed in or out proportionally. In case of zoom proportion more than 1, pressing direction button is able to move the picture, continuously press the button, "Zoom in 2,3,4,1/2, 1/3,1/4, Zoom in :off" will be displayed.

MP3 DISC PLAYING FUNCTION

1). Press the Eject button on the panel or remote control to open the deck, put in an MP3 disc, then press the Eject button to close the deck. This unit begins to read it, and the TV screen will display the following figure. If you are not attached to a TV then the disc will automatically begin to play.

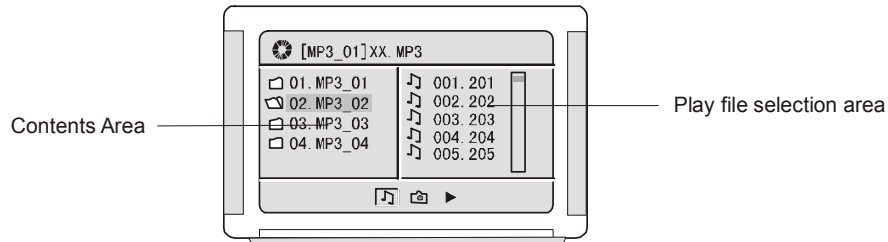

2). Press the directive keys ▲▼ to move the cursor to a certain directory, and press Play/Enter button to enter the directory. Press the direction buttons to enter the subdirectory or the file area, select a song with the cursor, press Play/Enter button to play the song.

- During play, press ◀◀ or ▶▶ button to select other songs under the current directory.
- During play, press the left direction button, the icon will skip to the directory symbol □, press the up/down direction button to select other directories, press Play/Enter buttons for confirmation.

Note: When playing MP3 discs, functions such as mute, pause, previous and next selection operate in the same way as CD playing.

VIEWING PICTURES

1). Before attempting to view any pictures on the player, please make sure that the pictures are either JPEG format and the videos are in MPEG4 format. Place the MPEG4/JPEG disc into the deck, the unit will begin to read the disc, the main directory will be displayed on the TV screen.

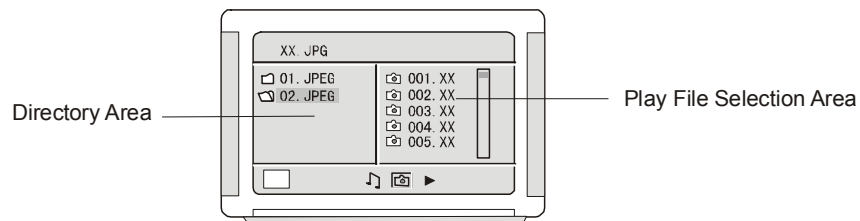

2). Press the direction button ▲▼ to move the cursor to the corresponding directory, press Play/Enter button to enter the next layer, and so on, until the desired picture is found for play.

- During play, the number buttons or **◀▶** buttons can be used to select pictures.
- For technical details, please visit at the www.ikasuhifi.com
- 0164-975-0458 (Office hours 9am-5pm) Monday to Friday.
- This unit can play the digital photo discs with extension name JPEG and Adobe photo shop.
- If you want to repeat playing some pictures, press the Repeat button to select the repeat type.
- During browsing , press the Stop button to go back to the main menu.

14

USB/DIGITAL CARD

In order to play media from either a SD/MMC or USB device simply plug the said device into the corresponding slot located under the flap on the front of the hifi.

1. Press the USB.D CARD key once on the remote control.
2. After entering the USB/DIGITAL CARD mode, press the " ▲ ▼ " key on the remote control to move the cursor to the corresponding option you wish to select.
3. Press the "Play/Enter" key to switch to the option that you want.
4. In the status of no disk, the machine will read the USB or Digital Card automatically. If there are some contents for playing, the machine will go into play or display the content automatically.

FM RADIO OPERATION

1. In order to enter the FM Function press the FM button on the remote control, or press Stop/FM button twice on the front panel to enter FM status.
2. To tune into the stations use one of the following methods.
 - 1) Directly input frequency: press the T/F button on the remote control; input the frequency that you want directly using the number keypad on the remote.
 - 2) Select a band by pressing Tune- or Tune+ button.
 - 3) Automatically search bands: press the Search button, this unit will start to search bands from the lowest part to highest part automatically. Meanwhile the searched bands will be saved orderly. Press the button again to stop searching.
3. Save Bands
Press the Save button, then press the number in which you wish to store your frequency. So if you want 29 as the stored channel then press the 10+ button twice then 9. Now press the T/F button an input the frequency, then press Save button to save this frequency.
4. Soundtrack Selection
Press MO/ST button, you may select Mono and Stereo soundtrack output in FM status. If the signal is not strong enough, you can not select Stereo.
5. Exit FM Status
Press the Play/Enter button to exit FM status and enter the disc playing.

Remark: FM Frequency range: 87-108MHz

- NOTE:
1. You may adjust the best radio effect by adjusting the FM antenna.
 2. You can search further bands by pressing Search button when adjusted the FM/AM antenna in a right position.
 3. If the band is not clear by auto search, you choose the way manual search adjustment by

DVD Menu Setup

Press the **Setup** button on the remote control to open the menu setup function, the TV screen will display the following options.

SYSTEM SETUP PAGE



1). TV System

Allows you to change the video output from: NTSC, PAL, AUTO.

2). Screen Saver

This option is used to open or close the screen saver to ON and OFF.

3). Video Output

Allows you to select the required video output mode: INTERLACE-YUV, TV-RGB, P-SCAN YPBPR, S-VIDEO.

(1) INTERLACE-YUV : this option can be chosen if Y, Cb, Cr are connected with a TV.

(2) TV-RGB : this option can be chosen if Y, Pb, Pr are connected with a TV, and the TV is switched to TV-RGB.

4). TV Type

Please select the right screen type according to your TV, includes 3 options,

4:3 LB: Mailbox format, the picture data without panoramic and scanning format will be played in this format.(Fig 1)

4:3 PS: For regular TV, the picture data with panoramic and scanning format will be played in this format.(The edges on both the left and right are removed) (Fig.2)

16:9 : For wide screen TV, to be played in full size.(Meanwhile, it is necessary to set the TV to FULL status.) (Fig.3)



Fig.1

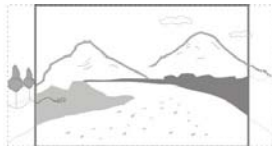

Fig.2



Fig .3

As shown above, each screen type is presented by one example.

Such setting will not affect the normal size of the picture data.

For technical Enquiries please call us on
 0161 975 0458 (Office hours: 9am-5pm) Monday to Friday

16

5). Password and Rating

The password is used to prevent the children watching inappropriate discs.

- (1) Input a four-digit password. (The initial password of this unit is 0000.)
- (2) Move the cursor to rating option, press Play/Enter button to select the desired rating.
- (3) Press the direction buttons to exit.

Note: You can not play the discs with a rating higher than your set rating, unless you input the correct password upon the system prompt.

Note: Rating selection can be done only when the password lock is open, and only when the password lock is locked, the rating restriction can take effect.

6). Default Value

This option is used to restore all the preset values for menu setup. Select Restore, this unit will return to the original setup.

LANGUAGE SETUP PAGE



1). OSD Language

This option is used to select the language for menu and other screen displays, includes English, German, French, Spanish and Dutch.

2). Audio Language

When playing a DVD disc, the player will automatically play the Pre-selected language, Includes English, German, French, Spanish, Portuguese, Italian, Dutch and Danish. If there is no such option in the disc, the default language of the disc will be played.

3). Subtitle Language

When playing a DVD disc, the player will automatically play the pre-selected subtitle if there is such a language in the disc. The options are as follows, English, German, French, Spanish, Portuguese, Dutch, Danish and OFF. If there is no such an option in the disc, the default subtitle language of the disc will be played.

4). Menu Language

When play DVD disc, this unit has 8 languages available: English, German, French, Spanish, Portuguese, Italian, Dutch and Danish.

Note: If there is no the language you selected in the DVD disc, the player will automatically play the default recorded in the disc.

For technical Enquiries please call us on
0161 975 0458 (Office hours 9am-5pm) Monday to Friday

17

AUDIO SETUP PAGE

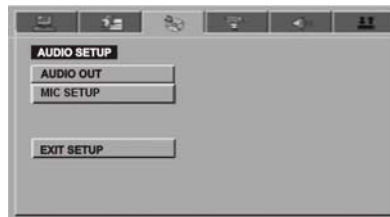

1). Audio Out

Each DVD disc has various audio output types for selection. You can set the type according to the acoustic system type you are using. Three options are available:

1. SPDIF/OFF: no signal output from either coaxial or optical output port
2. SPDIF/RAW: this option is chosen when the coaxial and optical port is connected with a power amplifier. When playing Dolby, MPEG discs, the coaxial or optical port (of this unit) will output the corresponding digital signal (source code format), here the connected power amplifier must have the decoding function for Dolby and MPEG.
3. SPDIF/PCM: this option can be chosen when the player is connected with the digital stereo amplifier with 2-channels. When play the Dolby, MPEG discs, the coaxial or optical output port will output 2-channel signal, which is modulated by PCM.

Microphone Setting

The options contain two items: AUTO and OFF

AUTO: You can sing the songs after the Mic output channel is connected.

OFF: Close the Mic output.(Note: The default is MIC OFF.)

VIDEO SETUP PAGE



1). Brightness

For technical Enquiries please call us on 0161 975 0438 (Office hours 9am-5pm) Monday to Friday
 This option is used to change the brightness of the screen, press the up/down direction button to adjust the brightness, press left direction button to exit.

2). Contrast

This option is used to change the contrast of the screen, press the up/down direction button to adjust the contrast, press left direction button to exit.

3). Hue

This option is used to change the hue of the screen, press the up/down direction button to adjust the hue, press left direction button to exit.

4). Saturation

This option is used to change the saturation of the screen, press the up/down direction button to adjust the saturation, press left direction button to exit.

SPEAKER SETUP PAGE



Down mix

- (1) LT/RT: Left and Right soundtrack audio output
- (2) Stereo: Stereo audio signal output
- (3) VSS: The main loudspeaker can output virtual surrounding sound effect.

DIGITAL SETUP PAGE



OP Mode

- (1) Line Output : to compress the input signal linearly, lower in volume and applicable to night.
- (2) RF Remod: no compression for the input signal, higher volume and applicable to day.

Dynamic Range

For technical Enquiries please call us on 0161 975 0458 (Office hours 9am-5pm) Monday to Friday

When the output mode is Line Output, this unit will automatically adjust the linear compression ratio to acquire different compression effect of signals. When the option Full is chosen, the peak value of the audio signal will be the minimum; when OFF is chosen, it will be the maximum.

Dual Mono

To set the output mode for left and right audio signal, Available options: Stereo, Mono L, Mono R and Mix Mono.

The pictures above will appear on the TV screen in case of menu setup. Every time a picture is chosen, you can use the direction buttons or Play/Enter button to switch over to a certain picture you are to set, then use the direction buttons to move the cursor onto a specific directory, press the Right direction button to enter the subdirectory and press the up/down direction button to change various status of a specific item. At last, press Play/Enter button to make the setup effective, and press the left direction button to return back to the upper level directory. Press the Setup button to exit the menu setup page.

SPECIFICATIONS

For technical Enquiries please call us on 0161 975 0458 (Office hours 9am-5pm) Monday to Friday		20
Disc Type	CD DVD VCD MP3 MP4	
Video Format	MPEG 2 for DVD, MPEG 1 for VCD	
Audio Format	MPEG 1, MPEG 2, PCM, STEREO	
Signal Output	Video system: NTSC, PAL, PAL60, AUTO Video output 1.0 V p-p Audio: stereo	
Output Joint	Chromatic aberration output, S-Video output, Stereo, Video output, Optical Fiber output, Coaxial output and Scart output	
Power Supply	~230V 50Hz	
Max.Power	50W	
Frequency Response	±3dB(20Hz-20KHz)	
Audio S/N	80dB Weight A	
Operating Condition	Temperature: 5--35°C Operating status: Level	
Others	FM radio receiver with 75 ohm jack Blue LED display with red color symbol Full function infrared remote control Power output 2 X 5W + 1 X 15W RMS power output	

Note: * Some MPEG 4 discs are in *.rm/ *.ra/ *.ram/ *.rmm etc format and are not supported by this device. Please select carefully before purchase. The specification is for reference only, subject to change without prior notice.



If at any time in the future you should need to dispose of this product, please note that: Waste electrical products should not be disposed of with household waste. Please Recycle where facilities exist. Check with your Local Authority or retailer for recycling Advice. (Waste Electrical and Electronic Equipment Directive)

Please use the following methods to solve the following problems while using this unit.

Fault	Possible Cause	Solution
Power supply can not be turned on	Power plug is not fully inserted into the socket	Insert the power plug into the socket securely
The remote control does not work	Battery is used up	Replace with a new battery
	The front end of the remote control is not aimed at the infrared reception part of the player	Please aim at the remote control window
No image on the TV screen	No video cables are connected or not securely connected	Perform connection according to system connection diagram
	TV not set at video mode	Set the TV at the video mode
	The scanning mode of the device does not match the TV scanning mode	Press line by line/alternate line key to convert scanning mode
The disc is not playing	No disk is placed into the guide slot	Place the disk into the guide slot
	No disk is in	Place in a disk
	Inverse placement of disk	Be sure that the side with pictures of the disk points upwards
No sound from loudspeaker	Video cable not connected or not connected securely	Connect the cable as per the diagram
	Wrong operations with external amplifier	Correct operations of amplifier
Discontinuous sound and distorted pictures	Disk not clean	Use a piece of clean and soft cloth to clean the disk
	Disk scratched	Replace the disk with a new one
	Disk distorted	
Invalid displayed on the TV screen	Wrong Operation	Please refer to the function operation description for more details
Operation can not be done	Embedded micro computer fails due to lightning, static or other interference	Power OFF, and restart the computer

For technical Enquiries please call us on
0161 975 0458 (Office hours 9am-5pm) Monday to Friday

22

TECHNICAL SUPPORT LINE

GENERAL SUPPORT CAN BE PROVIDED ON ALL
PRODUCTS PURCHASED FROM US
(Unfortunately we cannot provide support on products or components that we do not supply)

0161 975 0458

Calls cost National Rate, Unless dialing from 0161 area

CALLERS MUST BE MINIMUM OF 18 YEARS OF AGE
CALLERS MUST HAVE THE PERMISSION OF THE TELEPHONE SUBSCRIBER

ALL INFORMATION GIVEN IS CORRECT
AT THE DATE OF PUBLICATION - 13/07/2007

HOURS OF BUSINESS
MON – FRI 9am to 5pm (excludes bank holidays)

FASCIN8 LTD
14 EMBANKMENT BUSINESS PARK
VALE ROAD, HEATON MERSEY
STOCKPORT CHESHIRE, SK4 3GN

Alternatively visit our website for further support
www.fascin8.co.uk