

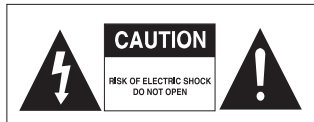

## Notice

**Read this manual carefully and make sure you understand the instructions provided. For your safety, check what the result of each action will be.**



**To reduce the risk of electric shock**, do not remove cover (or back). No user serviceable parts inside. Refer servicing to qualified service personnel. Indicates a situation which, if not avoided, could damage the equipment or other apparatus.\*



**This symbol** indicates dangerous voltage inside the TV that presents a risk of electric shock or personal injury. Indicates a hazardous situation which, if not avoided, could result in serious injury.



**This symbol** indicates important instructions accompanying the TV.



### **Disposal of electrical and electronic equipment**

This equipment must not be disposed with the normal domestic refuse. Please direct your inquiry to disposal to your local disposal enterprises, environmental paper of your municipality or to your dealer, where you bought this product. You can help to reduce the consumption of raw materials by recycling the devices and protect the environment by professional disposal.

## **Copyright (Copyright © 2006 HUMAX Corporation)**

Not to be copied, used or translated in part or whole without HUMAX's prior consent in writing except approval of ownership of copyright and copyright law.

## **Warranty**

The information in this document is subject to change without notice. HUMAX does not have any responsibility for direct, indirect, accidental and other damage caused by the use of the information contained in this manual.

## Trademarks

**VIACCESS™** is a trademark of France Telecom.

**CryptoWorks™** is a trademark of Philips Electronics N.V.

**Irdeto** is a trademark of Mindport BV.

**Nagravision** is a registered trademark of KUDELSKI S.A.

**Conax** is a trademark of Telenor Conax AS.

*Thank you for purchasing a HUMAX TV. Please read this user manual carefully in order to safely install, use and maintain the TV at maximum performance. Keep this user manual next to your TV to ensure the best performance possible.*



## General Safety Precautions

### Power

- Plug the power cord into the correct power outlet. An unstable connection may cause fire.
- Do not use damaged power cords or plugs, or use a loose wall outlet. This may cause electrical shock or fire.
- Do never touch the power cord with wet hands. This may cause electrical shock.
- Do not use multiple devices with one outlet. Overheating the outlet may cause fire.
- Do not bend or pull out the power cord using force, nor place heavy objects over it. This may cause electrical shock or fire.
- Make sure you pull out the power cord holding the plug itself. An internal disconnection may cause fire.
- When removing the product, turn off the power and pull out the plug from the power outlet. Also make sure other devices including the antenna or the connectors are removed from the outlets before relocating the product. Otherwise you may suffer electrical shock or fire due to a damaged power cord.
- This TV shall be connected to mains socket outlet with a protective earthing connection.
- The mains plug shall remain readily operable.

### Installation

- Keep the product away from any heating devices. Placing it close to a heating device may cause fire.
- Keep the power cord away from any heating devices. A melted coating may cause fire or electrical shock.
- Place the antenna as far away as possible from any high-voltage cables. Touching the high voltage wiring may cause fire or electrical shock.
- Do not install the product in oily, smoky or humid (or exposed to rain/water) places or automobiles. This may cause fire.
- The connection between the external antenna and the internal wiring should be turned inside to avoid any inflow of rain. Exposing the LCD to water (rain) will cause electrical shock or fire.
- Do not use the product in humid places. Humidity will shorten the life of the product and may cause an electrical shortage or fire.
- Do not use the product in places with low temperatures (below 5°C).
- Avoid installing the product in poorly ventilated places. Internal overheating may cause an electrical shortage and fire.
- Be sure not to cover the ventilator (with a table-cloth or curtain, etc.). Internal overheating may cause an electrical shortage and fire.
- Do not install the product in an unstable place or on a small stand. The product may cause serious injury, if it falls on somebody (especially children). Install it on an even, stable place as it is front-heavy.
- Do not install the product on the floor. Someone (especially children) may trip over it.

## Usage

- Unplug the product from the wall outlet and do not touch the antenna during a thunderstorm. This will prevent damage to the unit due to lightning and power-surges.
- Keep dust or water away from the pins or touching points of the power plug. This will prevent electrical shock or fire.
- Keep children from climbing over the product. The device may cause serious injury or death if it falls on them.
- Do not place anything over the product that children may try to reach. The device may cause serious injury or death if it falls on them.
- When removing the battery from the product, keep it out of children's reach. If a child swallows a battery, consult a doctor immediately.
- Use only specified batteries and do not use an old battery along with a new one. Align the batteries according to the correct polarity (+ or -). Aligning them incorrectly may cause an internal explosion or a leakage of the internal liquid, leading to electrical shock, physical damage or pollution of the surroundings.
- Do not insert any metal or a flammable object or an alien substance into the ventilator, the AV input terminal or the slots for the modules or Smartcards. This may cause damage to the product and reduce its life span.
- Do not disassemble, repair or reconstruct the product at your discretion. This may cause electrical shock or fire. Contact your local customer support.
- Keep the product away from inflammable sprayers or ignitable objects. Exposure to these may cause explosion or fire.
- Do not place water-pots, flower vases, beverage cans, small metals or heavy objects over the product. Contact of these contents with the product may cause electrical shock or fire, while any falling of the product may cause injury.
- If the product breaks down, turn off the power and unplug it from the outlet before contacting Customer Support. This will protect you from electrical shock or fire.
- When you notice something strange like an odd noise, smell something burning or see smoke, unplug the power cord and contact your local Customer Support. Do this to avoid electrical shock or fire.
- Do not use sharp tools such as a pin or a pencil near the TV, as they may scratch the LCD surface.
- Do not use a solvent, such as benzene, to clean the TV, as it will damage the LCD surface.



# Contents

Chapter 1 >> Getting Started .....	8
Package Contents.....	8
Front Panel .....	9
Rear & Side Panel .....	10
Remote Control Buttons.....	11
Installing on the Wall.....	13
Chapter 2 >> Connecting Your TV.....	14
Connecting to an Aerial or a Cable TV.....	14
Connecting to the VCR .....	15
Connecting to the DVD Player.....	17
Connecting to the Set-Top Box .....	18
Connecting to the Digital Audio System.....	19
Connecting to the PC.....	19
Connecting Headphones .....	20
Conditonal Access System .....	20
Chapter 3 >> Turning on Your TV.....	21
Turning on Your TV .....	21
Selecting the Menu Language .....	21
Selecting the Main Input Source.....	22
Setting Channels.....	22
Scanning Channels Automatically .....	22
Scanning Analog Channels Manually.....	23
Scanning Digital Channels Manually.....	24
Editing Analog Channels .....	24
Viewing Channel List .....	26
Displaying Information .....	29
Displaying Digital Teletext (MHEG).....	30
Changing Subtitle Language .....	30
Changing Audio Options .....	30
Chapter 4 >> Using the Electronic Programme Guide (EPG).....	31
Viewing the Electronic Programme Guide (EPG) .....	31

Chapter 5 >> Setting the Picture .....	33
Selecting the Picture Mode .....	33
Customizing the Picture Settings .....	33
Fleshtone .....	34
Colour Temperature .....	34
Setting the Aspect Ratio.....	35
Noise Reduction.....	36
Chapter 6 >> Setting the Sound .....	37
Setting the Sound Mode .....	37
Customizing the Sound Settings.....	37
Setting the Loudness .....	38
Adjusting the Volume Automatically.....	38
Setting up Audio Priority.....	39
Setting the Sound Effect .....	39
Chapter 7 >> Setting the System .....	40
Setting the Current Time Information.....	40
Parental Control .....	41
Common Interface .....	42
Status.....	42
Chapter 8 >> Teletext information .....	43
Displaying Teletext information .....	43
Chapter 9 >> Setting the PC .....	44
Auto Configure .....	44
Position .....	44
Phase.....	45
Clock.....	45
Reset.....	45
Menu Structure .....	46
Troubleshooting.....	47
Specification .....	48
Service and Support.....	49



## Package Contents

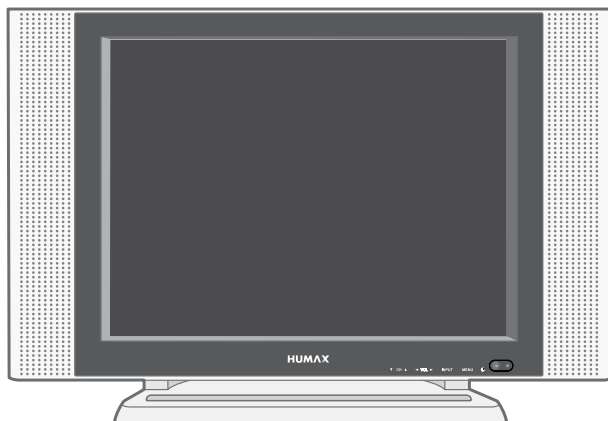

LCD TV



User's manual

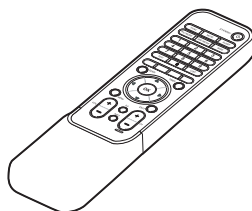

Remote control

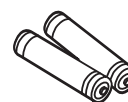

AAA batteries (X2)



## Front Panel

LED touch buttons are displayed on the front panel.

You can simply touch LED buttons to control some main functions such as selecting a main input, using the OK command, displaying menus, adjusting volume, and switching channels.

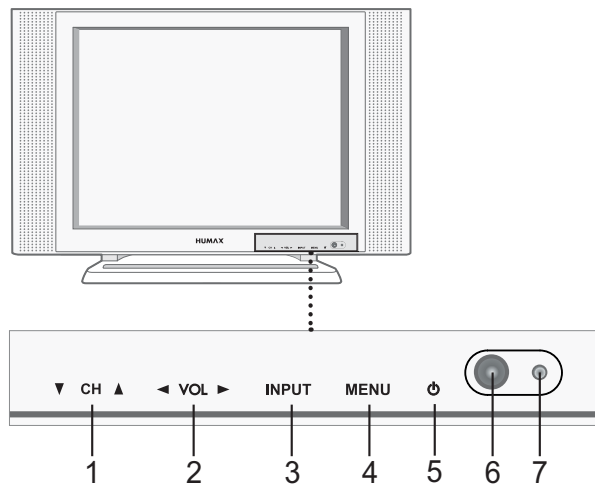

- 1 **▼ CH ▲** buttons  
Selects channels.
- 2 **◀ VOL ▶** buttons  
Adjusts the volume.
- 3 **INPUT** button  
Displays input source.
- 4 **MENU** button  
Displays the on-screen menu.
- 5 **Standby** button  
Sets your TV in standby mode.
- 6 **Remote control sensor**  
Receives commands directly from your remote control and passes them on.
- 7 **Standby indicator**  
Turns on blue during the standby mode.



## Rear & Side Panel

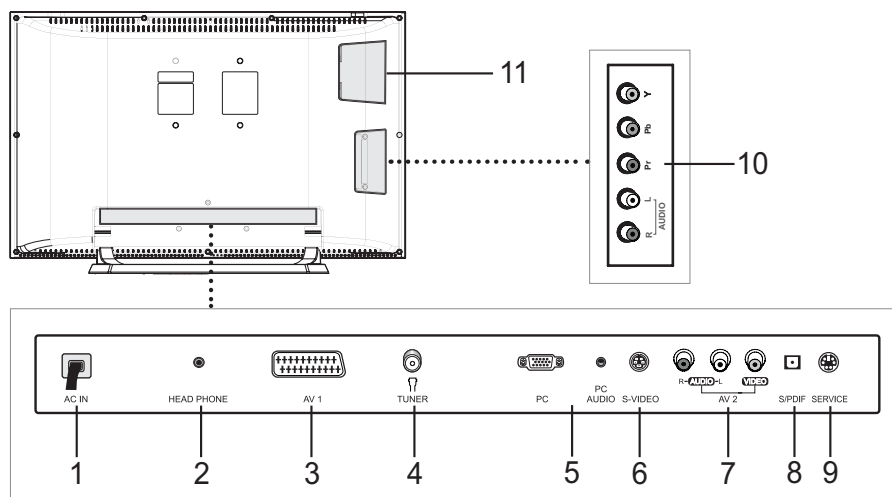

### 1 AC INPUT

Connects to the wall outlet.

### 2 HEAD PHONE

Connects to headphones.

### 3 AV1 INPUT (SCART)

Inputs or outputs for external devices, such as VCR, DVD, video game console or video disc players. AV1 jack outputs only TV signal.

### 4 TUNER

Connects to an antenna or a cable system.

### 5 PC INPUT (PC, PC AUDIO)

Connects to the video and audio output jacks on your PC.

### 6 S-VIDEO INPUT

Connects to the S-Video jack of a camcorder, video game console, and similar devices.

### 7 AV2 INPUT

Connects to the audio and video output jacks of a camcorder, videogame and similar devices.

### 8 S/PDIF OUTPUT

Connects to a digital audio component. (digital audio output only)

### 9 SERVICE (RS232C)

Used as a service port for upgrading the TV's software.

### 10 COMPONENT INPUT

Connects to Video (Y/PB/PR) and audio (L/R) components.

### 11 CI (Common Interface) SLOT

A slot for a CI Module.

## Remote Control Buttons

### Number (0~9) buttons

Enters the channel number for direct display. Used to enter digit numbers.

### TEXT

Shows MHEG (digital teletext information)

### LIST

Displays channel list.

### Coloured buttons

Used for interactive applications in the EPG, Edit Programmes, and Teletext mode.

### GUIDE

Displays the Electronic Programme Guide (EPG) in DTV mode.

### TIMER

Displays the Time menu.

### MENU

Displays the On Screen Display (OSD) menu.

### EXIT

Exits from the currently displayed menu.

### Arrow (▲/▼/◀/▶) buttons

Controls the selection in the On Screen Display (OSD) menu.

### OK

Confirms (save or enter) your choice.

### D/A

Switches between digital and analog channels.

### VOL+/-

Adjusts the volume.

### INFO

Displays information on digital channels and programmes.

### CH+/- (Page)

Switches channels or teletext pages.

### ⏮ (SOUNDTRACK)

Selects the sound mode in ATV mode and the audio language in DTV mode.

### 📄 (Subtitle)

Displays subtitle on the screen.

### DTV/RADIO

Switches between digital TV channels and digital radio channels.

### FAV

Switches to a favourite channel. Circulates through favourite channels in sequent order while watching TV.

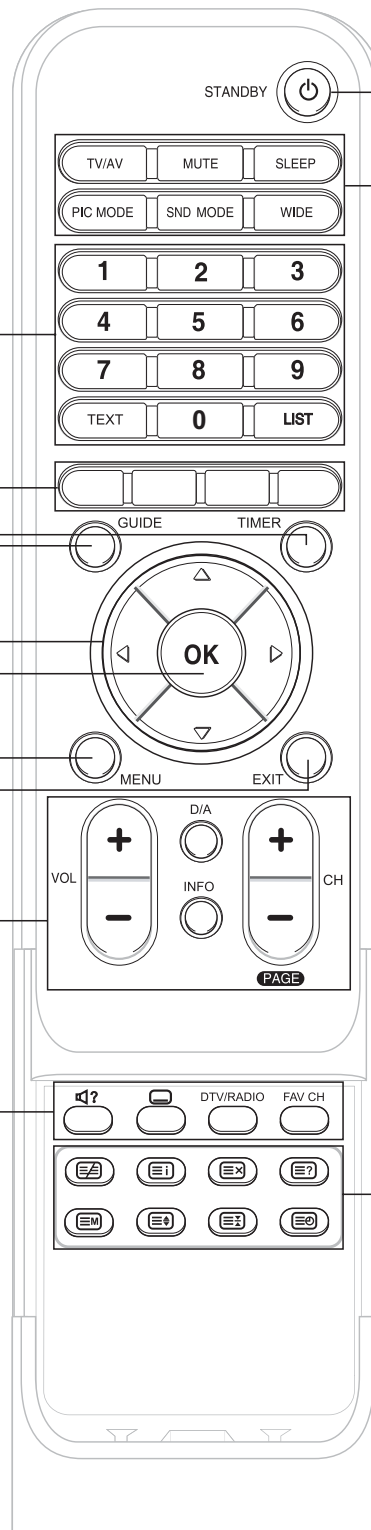

### STANDBY

Puts your TV in standby mode.

### MUTE

Mutes the sound. To cancel, press the MUTE, VOL+, or VOL- button.

### TV/AV

Displays all available input sources. Press the ▲/▼ button to select a required input source.

### SLEEP

Selects a preset time interval for switching the TV to standby mode automatically.

### PIC MODE

Selects the picture mode (Dynamic, Movie, Mild, Standard, or Custom).

### SND MODE

Selects the sound effect modes (Speech, Movie, Music, or Custom).

### WIDE

Select the aspect ratio (Auto, 4:3, or 16:9)

### TELETEXT Function Buttons

#### 📄 (Teletext On/Mix/Off)

Activates the teletext service and overlaps the teletext with the broadcasting screen.

#### 📄 (Index)

Displays the teletext index page.

#### 📄 (Cancel)

Displays the TV programme when searching for the new teletext page.

#### 📄 (Reveal)

Shows the hidden information.

#### 📄 (Mode)

Selects the teletext mode (LIST/FLOF)

#### 📄 (Size)

Displays the double-size letters.

#### 📄 (Hold)

Holds the current teletext page not updating it.

#### 📄 (Time)

When viewing a TV programme, press this button to display the current time at the top right hand corner of the screen.



## ■ Inserting Batteries into the Remote Control

You must insert or replace the batteries in the remote control when:

- + You just purchased TV
- + Remote control does not work

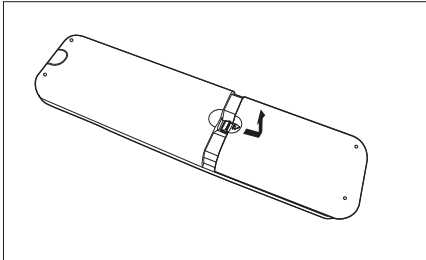

- 1 Remove the cover on the rear of the remote control by pressing the symbol (▼) downwards and then pulling firmly to remove it.
- 2 Insert two AAA size 1.5V batteries ensuring that the plus(+) and minus(-) signs of the batteries are correctly aligned.
- 3 Close the cover.

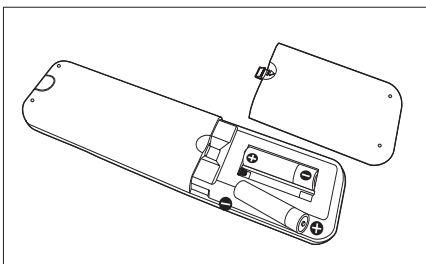

---

**Note:** Do not mix different battery types such as alkaline with manganese.

---

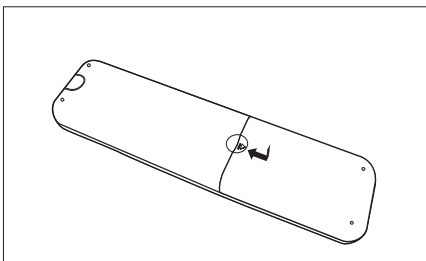

## Installing on the Wall

You can install the TV on the wall using a mounting bracket (sold separately).

**TIP:** This Television is compliant with the VESA wall mounting standard. A variety of Mounts are available through your local retailer. Each may have its unique installation instructions.

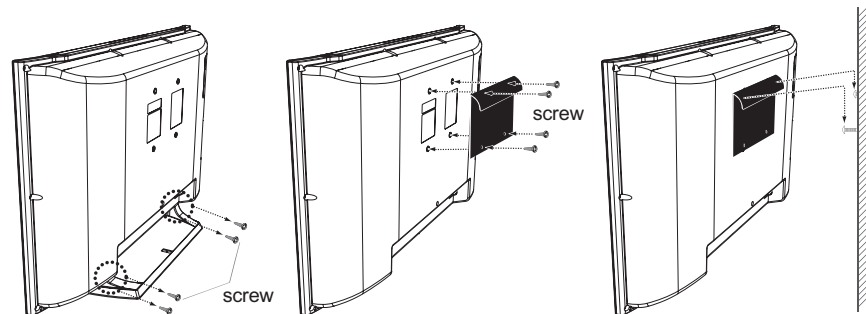

- 1 Before you install, open the rear flap of your TV and then separate the TV and stand-base by removing the screws.
- 2 Attach your main body bracket on the TV and fix using screws firmly.
- 3 Stick the TV with main body bracket into the wall bracket attached on the wall.
- 4 Tighten up a safety-screw.

**Notes:**

1. Please ask the installers to install the wall mount bracket.
2. Do not install the set on a weak surface such as plaster or foam board.
3. Please tightly secure the wall mount bracket to the wall to avoid injury from a falling TV.
4. Be at enough distance to open the Access card slot's door between the TV and the wall when installing on the wall. If the TV is not at proper distance from the wall, the door may be not opened enough.



## Connecting to an Aerial or a Cable TV

To view the television channels correctly, a signal must be received by the broadcasting provider.

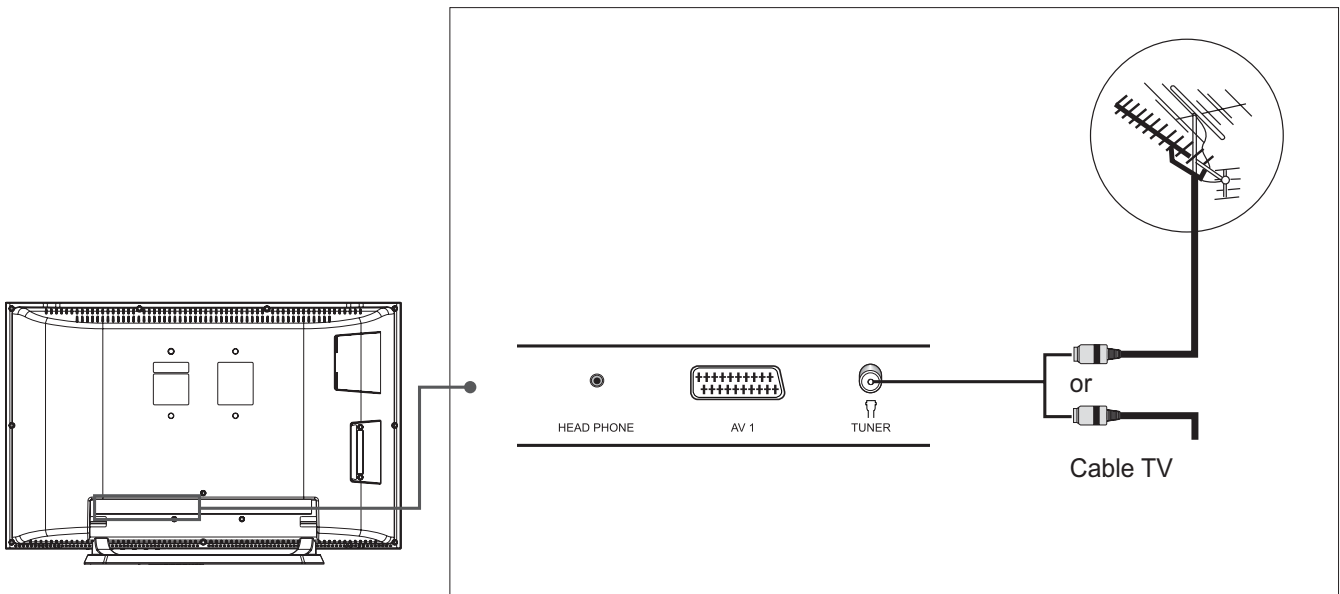

- 1 Connect the RF coaxial cable from an aerial or a cable TV to the **TUNER** jack on the rear of the TV.
- 2 Turn on the TV, and then press the **TV/AV** button to select **TV**.

---

### Notes:

1. To receive an optimal signal, it is recommended that you use a 75 ohm F-type coaxial cable.
  2. For proper reception of signals, an external antenna is required. For best reception, an outdoor antenna is recommended.
  3. To improve the picture quality in a poor signal area, please purchase a signal amplifier and install properly.
-

## Connecting to the VCR

### Using the SCART Cable

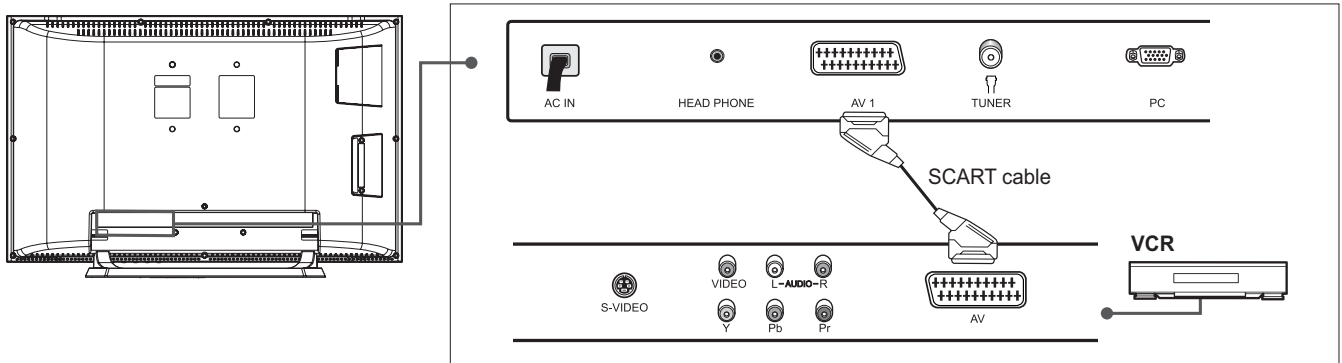

- 1 Connect the SCART cable between the **AV1** jack on TV and the SCART jack on your VCR.
- 2 Turn on the TV, and then press the **TV/AV** button to select **AV1**.
- 3 Turn on your VCR, then insert a video cassette into the VCR and press the **PLAY** button on your VCR. (Refer to the VCR owner's manual)

### Using the Audio/Video (Composite) Cable

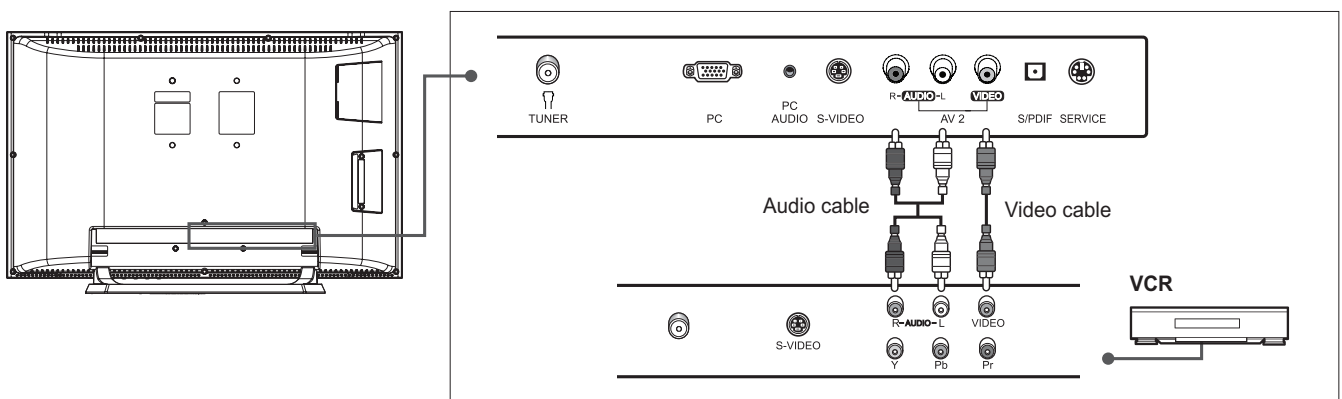

- 1 Connect the video cable between the **VIDEO (AV2)** input jack on TV and the video output jack on your VCR.
- 2 Connect the audio cable between the **AUDIO-L/R (AV2)** input jacks on TV and the audio output jacks on your VCR.
- 3 Turn on the TV, and then press the **TV/AV** button to select **AV2**.
- 4 Turn on your VCR, then insert a video cassette into the VCR and press the **PLAY** button on the VCR. (Refer to the VCR owner's manual)

**Note :** Do not play the AV devices which are connected to the **VIDEO (AV2)** jack and the **S-VIDEO** jack at the same time. Both videos could be displayed at the same time.



## Using the Audio/S-Video Cable

S-Video carries the video data as two separate signals (brightness and colour), unlike composite video which carries the entire set of signals in one package. S-Video does not carry audio. Hence, a separate audio connection is required.

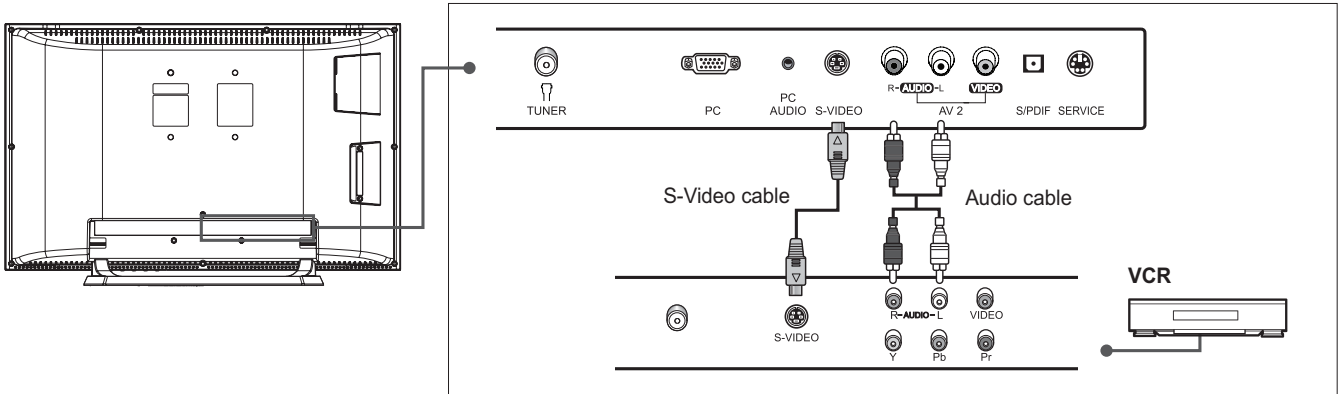

- 1 Connect the S-Video cable between the **S-VIDEO** input jack on TV and the S-Video output jack on your VCR.
- 2 Connect the audio cable between the **AUDIO-L/R (AV2)** input jacks on TV and the audio output jacks on your VCR.
- 3 Turn on the TV, and then press the **TV/AV** button to select **S-Video**.
- 4 Turn on your VCR, then insert a video cassette into the VCR and press the **PLAY** button on your VCR. (Refer to the VCR owner's manual)

---

**Note :** Do not play the AV devices which are connected to the **VIDEO (AV2)** jack and the **S-VIDEO** jack at the same time. Both videos could be displayed at the same time.

---



## Connecting to the DVD Player

### Using the SCART Cable

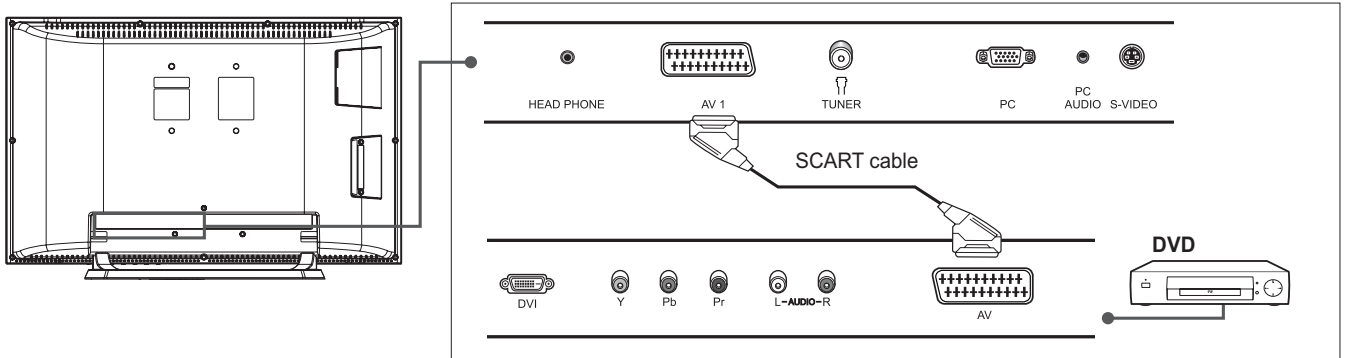

- 1 Connect the SCART cable between the **AV1** jack on TV and the SCART jack on your DVD player.
- 2 Turn on the TV, and then press the **TV/AV** button to select **AV1**.
- 3 Turn on your DVD player, and then insert a DVD into the DVD player and press the **PLAY** button on your DVD player. (Refer to the DVD player owner's manual)

### Using the Audio/Component Video Cable

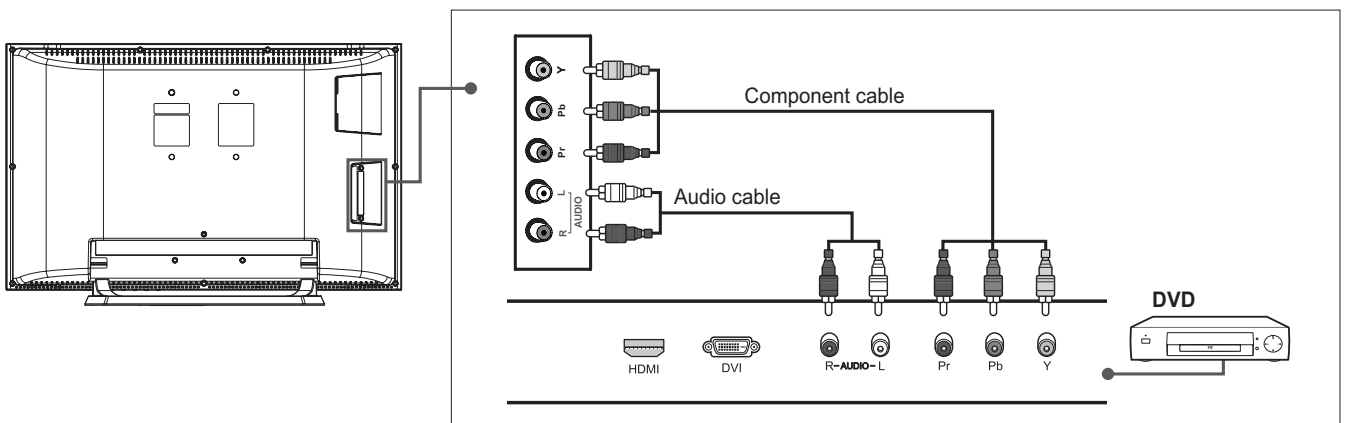

- 1 Connect the component video cables between the **COMPONENT VIDEO - Y/Pb/Pr** input jacks on TV and the component video output jacks on your DVD player.
- 2 Connect the audio cable between the **AUDIO-L/R** (for COMPONENT) input jacks on TV and the audio output jacks on your DVD player.
- 3 Turn on the TV, and then press the **TV/AV** button to select **Component**.
- 4 Turn on your DVD player, then insert a DVD into the DVD player and press the **PLAY** button on your DVD player. (Refer to the DVD player owner's manual)

**Note:** Depending on the manufacturer, the Y/Pb/Pr jacks may be identified as Y/P<sub>B</sub>/P<sub>R</sub>, Y/B-Y/R-Y or Y/C<sub>B</sub>/C<sub>R</sub>.



## Connecting to the Set-Top Box

### Using the SCART cable

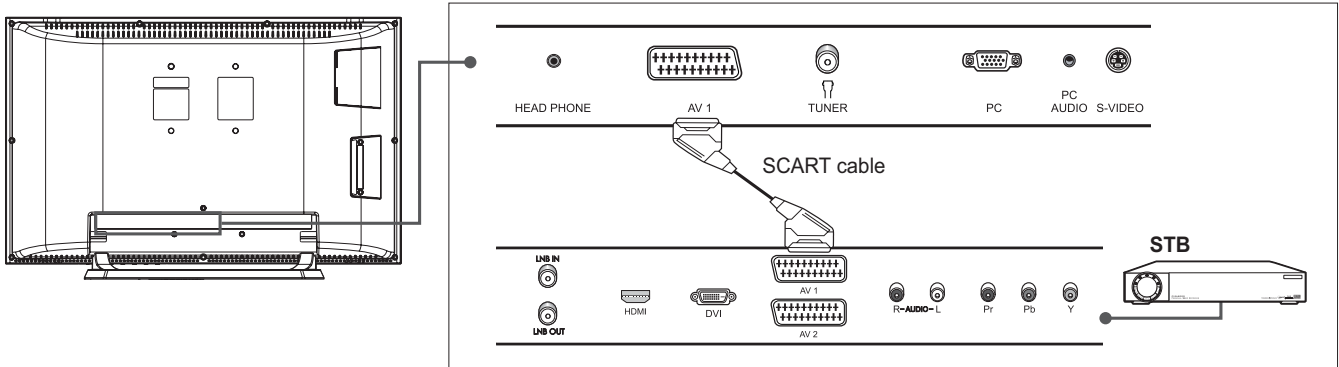

- 1 Connect the SCART cable between the **AV1** jack on TV and the SCART jack on your STB.
- 2 Turn on the TV, and then press the **TV/AV** button to select **AV1**.
- 3 Turn on your STB. (Refer to the STB owner's manual)

### Using the Audio/Component Video Cable

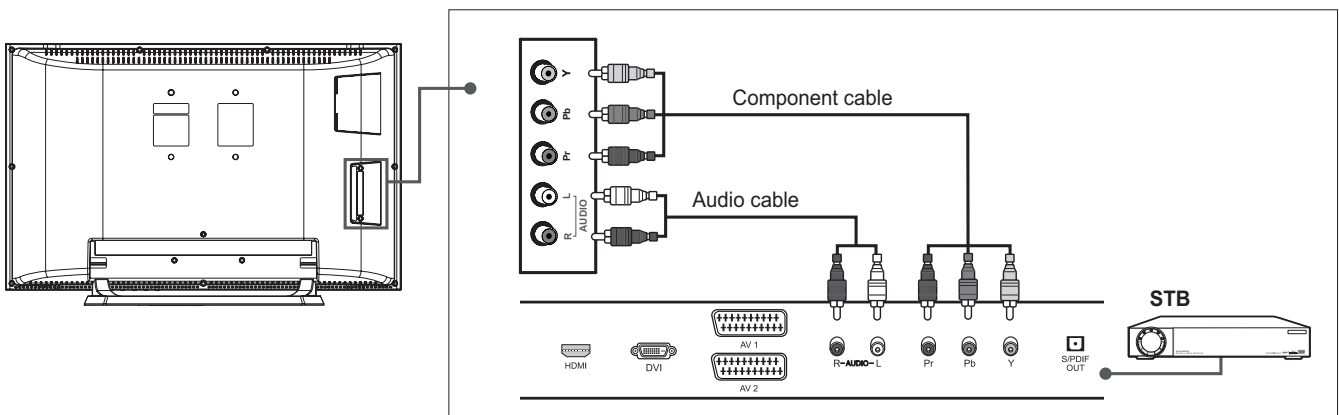

- 1 Connect the component video cables between the **COMPONENT VIDEO - Y/Pb/Pr** input jacks on TV and the component video output jacks on your STB.
- 2 Connect the audio cable between the **AUDIO-L/R** (for COMPONENT) input jacks on TV and the audio output jacks on your STB.
- 3 Turn on the TV, and then press the **TV/AV** button to select **Component**.
- 4 Turn on your STB. (Refer to the STB owner's manual)

**Note:** Depending on the manufacturer, the Y/Pb/Pr jacks may be identified as Y/P<sub>B</sub>/P<sub>R</sub>, Y/B-Y/R-Y or Y/C<sub>B</sub>/C<sub>R</sub>.

## Connecting to the Digital Audio System

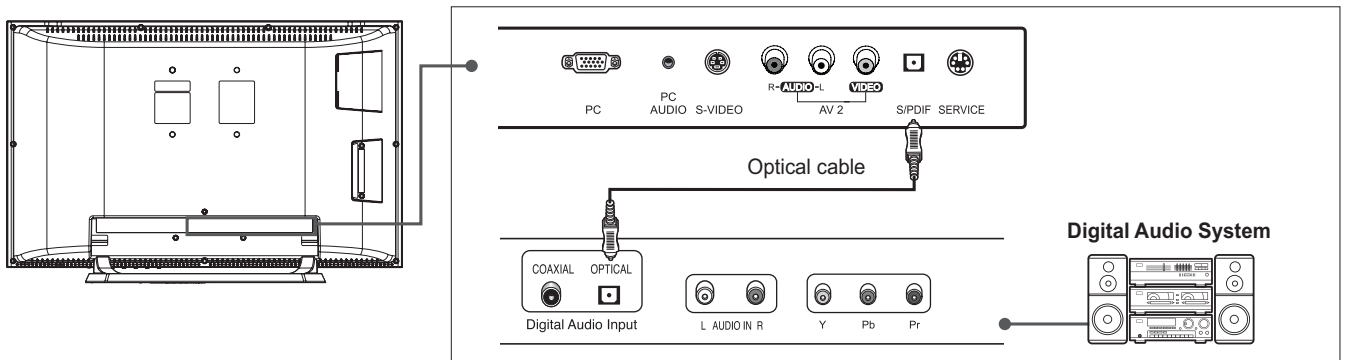

- 1 Connect the optical cable between the **S/PDIF** jack on TV and the optical input jack on your digital audio system.
- 2 Turn on the TV and your Digital Audio System, and then adjust the volume. (Refer to the Digital Audio System owner's manual)

### Notes:

1. In order to enjoy the sound from the Digital Audio System, press the **VOL+/-** button or **MUTE** button to minimise the volume or to cut off the sound from the TV.
2. Do not use optical cables larger than 27mm in length. They may not be inserted properly into the S/PDIF jack on your TV.

## Connecting to the PC

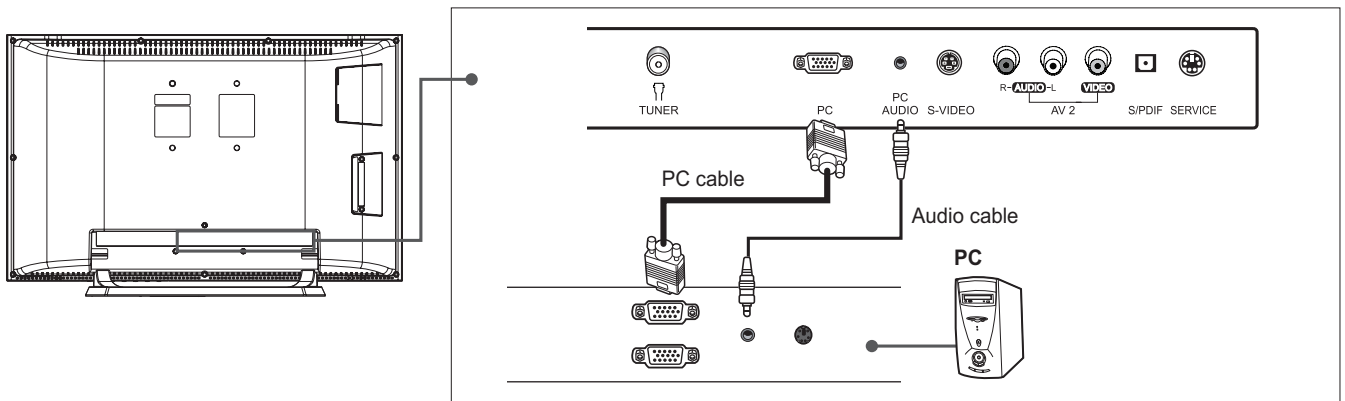

- 1 Connect the PC cable between the **PC** jack on TV and the PC output jack on your PC.
- 2 Connect the audio cable between the **PC AUDIO** jack on TV and the audio output jack on your PC.
- 3 Turn on the TV, and then press the **TV/AV** button to select **PC**.

### Supported Display Resolution (PC)

Mode	Resolution	Horizontal Frequency (kHz)	Vertical Frequency (Hz)
VESA	640 x 480	31.5	60
	800 x 600	37.9	60
	1024 x 768	48.4	60



## Connecting Headphones

Connect a set of headphones to **H/P** jack on TV if you want to watch a television programme without disturbing other people close to you.

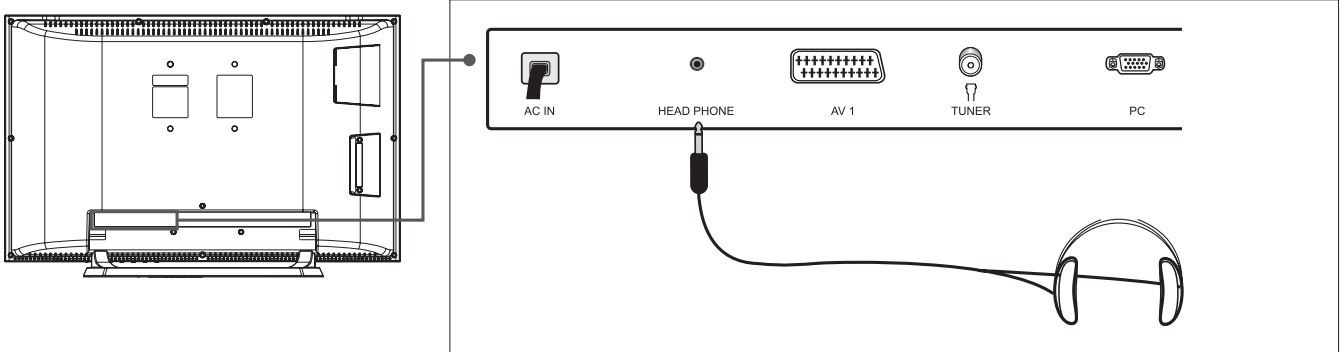

**Note:** Prolonged use of headphones at a high volume may cause health damage on your ears.

## Conditional Access System (for the digital channels only)

Conditional Access System (CAS) is a technology used to control access to digital television (DTV) services to authorised users by encrypting the transmitted programming.

### Inserting a CI Module (with Smartcard)

CI Module looks like a PC Card (called PCMCIA) for laptops. There are different kinds of CI Modules, suitable for different coding systems.

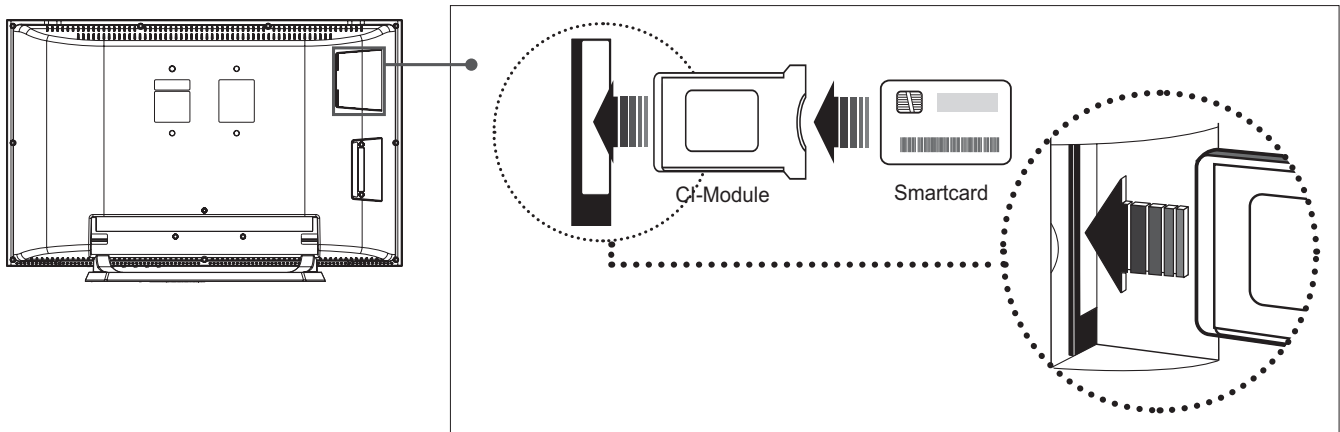

- 1 Follow the instructions of the module and insert the Smartcard into the Common Interface (CI) module.
- 2 Keep the CI module(with the Smartcard) vertically.
- 3 Insert the CI module completely into the slot.

**Note:** Ensure the Smartcard or CI module is inserted in the right direction. Inserting in the wrong direction may cause damage to the Smartcard or CI module.

## Turning on Your TV

To turn on your TV, do as follows:

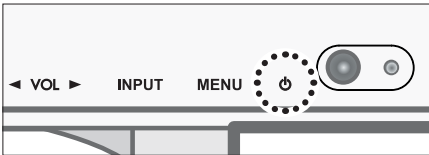

- 1 Connect the power cord on TV to the wall outlet. The standby indicator lights up.
- 2 Press the **STANDBY** button on your remote control (or on the front of your TV) to turn on the TV.

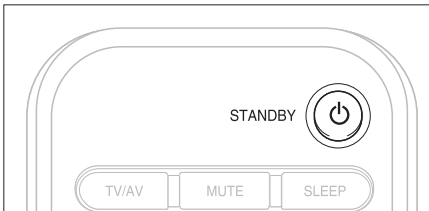

### Notes:

1. If the **Child lock** is turned on, the password is required when turning on your TV.
2. To set your TV in standby mode, press the **STANDBY** button again on the remote control or (⏻) on the front of your TV. It saves the electric usage when you want to stop watching TV temporarily (during a meal, for example).

- 3 To turn off the TV, disconnect the power cord.

**Note:** Do not leave your TV in standby mode for too long (on holiday, for example). Turn off the TV by disconnecting the power cord.

## Selecting the Menu Language

When you start using your TV for the first time, you must select the language for displaying menus and indications.

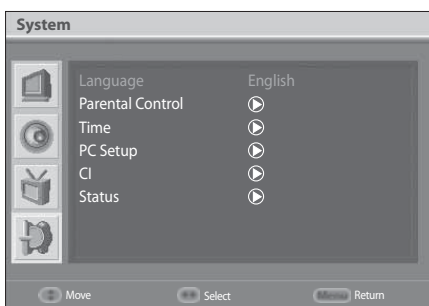

- 1 Press the **MENU** button.
- 2 Select **System** using the ▲/▼ button and press the ► button.
- 3 Select the language of your choice using the ◀/▶ button. The On Screen Display (OSD) menu will be shown in the selected language.
- 4 Press **EXIT** button to return to Live TV or press the **MENU** button to return to the previous menu.



## Selecting the Main Input Source



Once you have connected your various audio and video systems, you can view different sources by selecting input sources.

- 1 Press the **TV/AV** button.
- 2 Select the main input among the sources below using the **▲/▼** button or by pressing the **TV/AV** button repeatedly.  
**TV > AV1 > AV2 > S-Video > Component > PC**
- 3 Press the **OK** button.

**Note** : You can switch between the digital channels and analog channels using the **D/A** button.

## Setting Channels

### Scanning Channels Automatically

You can automatically scan channels for the frequency ranges available (availability depends on your region).

*You can access to the **Channel** menu only in the **TV** input mode. Please make sure the main input is set to **TV** using the **TV/AV** button.*

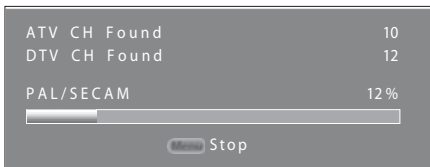
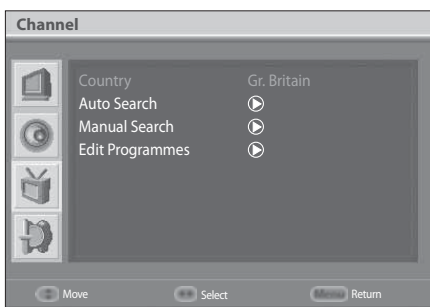

- 1 Press the **MENU** button
- 2 Select **Channel** using the **▲/▼** button and press the **▶** button.
- 3 Password is required to access the **Channel** menu. Enter your password using the **NUMBER (0~9)** buttons.
- 4 Select **Country** using the **▲/▼** button.
- 5 Select the country where you are now located using the **◀/▶** button.
- 6 Select **Auto Search** using the **▲/▼** button and press the **▶** button. It starts to scan channels. First scans analog and then digital channels. The scanned channels are automatically saved in order. To stop scanning channels, press the **MENU** button.

**Note**: After the channel scanning completes, the first scanned analog channel, if only, will be automatically displayed.

## Scanning Analog Channels Manually

You can save each channel name and programme number as you identify.

*Analog channels can be scanned only in analog TV input mode. Please make sure the main input is set to analog TV using the **TV/AV** and **D/A** buttons.*

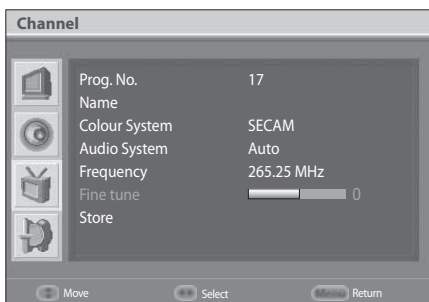
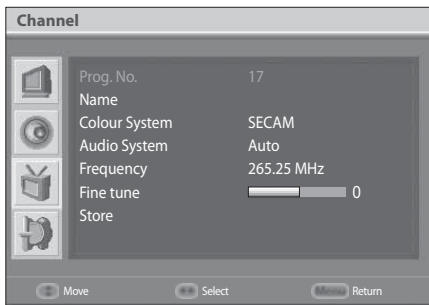
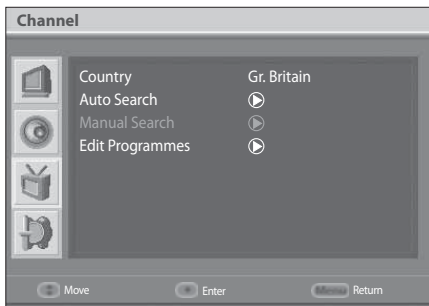

- 1 Press the **MENU** button.
- 2 Select **Channel** using the **▲/▼** button and press the **▶** button.
- 3 Password is required to access the **Channel** menu. Enter your password using the **NUMBER (0~9)** buttons.
- 4 Select **Manual Search** using the **▲/▼** button and press the **▶** button.
- 5 Select **Prog. No.** using the **▲/▼** button and select the programme number you would like to assign by pressing the **◀/▶** or **NUMBER (0~9)** buttons.
- 6 To change channel names, select **Name** using the **▲/▼** button and press the **▶** button.
- 7 Enter the new channel name using the **▲/▼/◀/▶** buttons.  
To select a letter (A~Z, a~z), a number (0~9) or a symbol (? ! # - +), press the **▲** or **▼** button.  
To move on the previous or next letter, press the **◀** or **▶** button.  
To store the changing name, press the **OK** button.
- 8 Select **Colour System** using the **▲/▼** button.
- 9 Select the required broadcasting standard (**Auto**, **PAL**, or **SECAM**) using the **◀/▶** button.
- 10 Select **Audio System** using the **▲/▼** button.
- 11 Select the required audio system (**Auto**, **BG**, **I**, **DK** or **L**) using the **◀/▶** button.
- 12 Select **Frequency** using the **▲/▼** button.
- 13 To tune of your desired frequency, press the **◀/▶** button or enter your desired frequency using the **NUMBER (0~9)** buttons.
- 14 Select **Fine tune** using the **▲/▼** button and press the **◀/▶** button to obtain a good quality of the picture and sound until you reach the optimal setting.
- 15 Select **Store** and press the **◀** or **▶** button to store.



## Scanning Digital Channels Manually

You can manually select to scan digital channels. The channel numbers are determined by the broadcasting stations.

*Digital channels can be scanned only in digital TV input mode. Please make sure the main input is set to digital TV using the **TV/AV** and **D/A** buttons.*

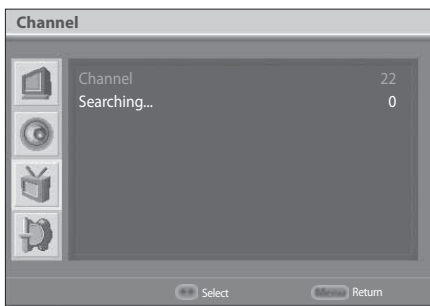

- 1 Press the **MENU** button.
- 2 Select **Channel** using the ▲/▼ button and press the ► button.
- 3 Password is required to access the **Channel** menu. Enter your password using the **NUMBER (0~9)** buttons.
- 4 Select **Manual Search** using the ▲/▼ button and press the ► button.
- 5 Select the channel number that you want to scan using the ◀/▶ or **NUMBER (0~9)** buttons. The searching of the selected channel is started. When completed, the number of scanned programmes will be displayed.

## Editing Analog Channels

After channel scanning completes, you can delete, move, lock, and skip saved analog channels.

*Analog channels are editable only in analog TV input mode. Please make sure the main input is set to analog TV using the **TV/AV** and **D/A** buttons.*

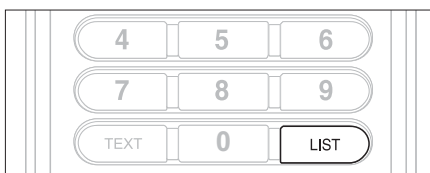
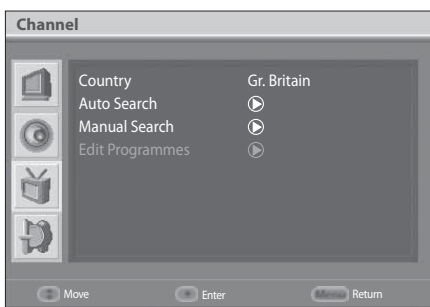

- 1 Press the **MENU** button.
- 2 Select **Channel** using the ▲/▼ button and press the ► button.
- 3 Password is required to access the **Channel** menu. Enter your password using the **NUMBER (0~9)** buttons.
- 4 Select **Edit Programmes** using the ▲/▼ button and press the ► button.

### Notes:

1. **Edit Programmes** menu is available for analog channels only.
2. You can access the **Edit Programmes** menu by simply pressing the **LIST** button on the remote control when watching analog channels.
3. Digital channels are editable only in the **Channel List** when watching digital channels. Refer to the '**Viewing Channel List**'.



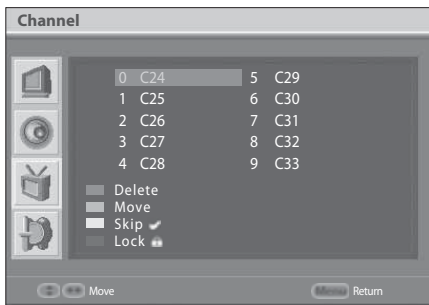

### Deleting Channels

You can delete channels from the list.

- 1 Select a channel you want to delete using the ▲/▼/◀/▶ button and press the **RED** button and then press the **RED** button again. The selected channel is deleted.

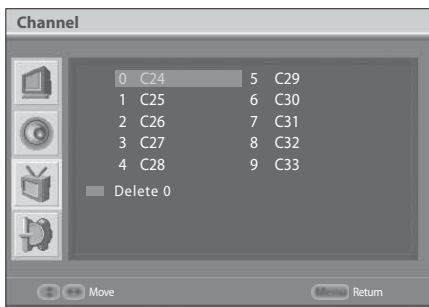

### Moving the Location of Channels

You can change the location of channels in the channel list of **Edit Programme** menu.

- 1 Select a channel to move the channel location using the ▲/▼/◀/▶ button and press the **GREEN** button.
- 2 Move the selection to a new location in the channel list using the ▲/▼/◀/▶ button, and press the **GREEN** button again. The selected channel is moved to its new location and all other channels are shifted accordingly.

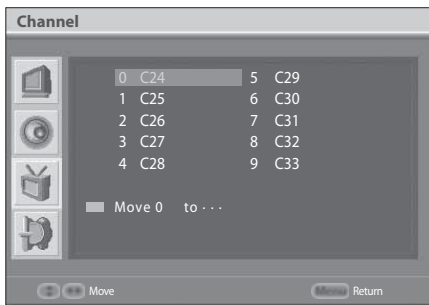

### Skipping Channels

Once channels are selected to skip, you can select the skipped channels using **NUMBER (0~9)** buttons only. The **CH+/-** buttons will not function for the skipped channels.

- 1 Select a channel to skip using the ▲/▼/◀/▶ button and press the **YELLOW** button.  
(✓) mark appears next to the channel name.

To clear the skipped channels, select the channel you don't want to skip and press the **YELLOW** button.

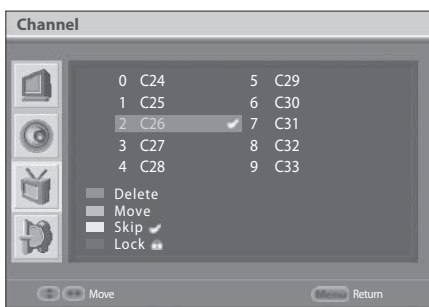

### Locking/Unlocking Channels

You can lock or unlock one or more channels.

- 1 Select a channel you want to lock using the ▲/▼/◀/▶ button and press the **BLUE** button.  
(🔒) mark appears next to the channel name.

To unlock the locked channels, select the channel you want to unlock and press the **BLUE** button.

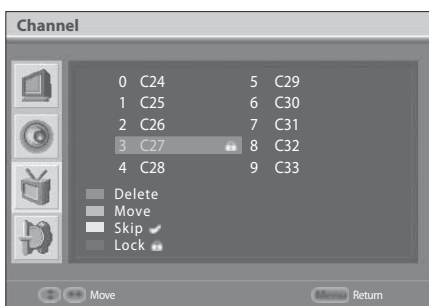

**Note** : To watch the locked channels, you must enter the password using the **NUMBER (0~9)** buttons.



## Viewing Channel List (for the digital channels only)

You can view the list of all digital channels using the **LIST** button and edit the digital channels on the channel list.

If you press the **LIST** button while watching the digital channels, the **Channel List** appears. **Channel List** shows the list for the digital channels and allows you to edit the digital channels.

**Note:** If you press the **LIST** button while watching the analog channels, the **Edit Programmes** menu appears. **Edit Programmes** menu shows the list for the analog channels and allows you to edit the analog channels. Refer to the **Chapter 3. Turning on Your TV > Setting Channels > Editing Analog Channels**.

### Editing Digital Channels

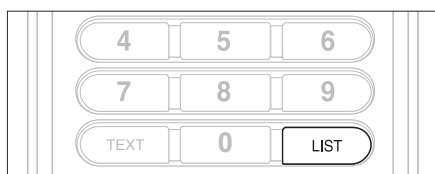

- 1 Press the **LIST** button while watching the digital channels. The **Channel List** appears as followings.

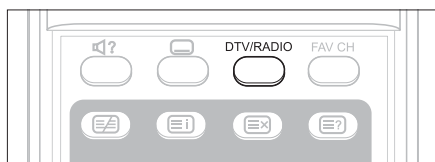

- 1. Channel list mode (Show all, TV only, or Radio only)**  
: Displays the channel list by mode by pressing the **DTV/RADIO** button.
  - 2. Channel list**  
: Displays the number and name of the scanned digital channels. Select your desired channel using the **▲/▼** button.
  - 3. Function buttons**  
: Selects, deletes, renames or locks the channels. Select your desired function using the **◀/▶** button.
  - 4. Preview window**  
: Displays the selected channel previously.
- 2 To tune the channel**, select a channel you want to tune using the **▲/▼** button and select **Select** using the **◀/▶** button and then press the **OK** button. The selected channel is displayed in the preview window.

- 3 To delete the channel**, select a channel you want to delete using the ▲/▼ button and select **Delete** using the ◀/▶ button and then press the **OK** button.

If you select **Yes** for the confirm message and press the **OK** button, the selected channel will be deleted.

- 4 To edit the channel name**, select a channel you want to rename using the ▲/▼ button and select **Edit Name** using the ◀/▶ button and then press the **OK** button. The editing box appears.

Enter a channel name directly using the ▲/▼/◀/▶ button and press the **OK** button.

To select a letter (A~Z, a~z), a number (0~9) or a symbol (space, { } ~ ! " # \$ % & ( ) \* + , - . / : ; < = > ? @ [ \ ] ^ \_ `), press the ▲ or ▼ button. To move on the previous or next letter, press the ◀ or ▶ button.

- 5 To lock or unlock the channel**, select a channel you want to lock/unlock using the ▲/▼ button and select **Lock** using the ◀/▶ button and then press the **OK** button.

Enter your password using the **NUMBER (0~9)** buttons.

If you select the unlocked channel, the channel is locked and (🔒) mark appears next to the channel name. If you select the locked channel, the channel is unlocked and (🔓) mark disappears.

---

**Notes:**

1. Analog channels are editable only in the **Edit Programmes** menu when watching analog channels. Refer to the Chapter 3. **Turning on Your TV > Setting Channels > Editing Analog Channels**.
  2. The Default Password is "0000". If you have forgotten your password, please contact your local TV distributor.
-



## ■ Editing Favourite Digital Channels

You can add the favourite channels or remove the favourite channels from the favourite list.

- 1 In **Channel List**, select **Favourites** using the ◀/▶ button and then press the **OK** button.  
The **Edit Favourite Lists** appears.



- 2 Select a channel you want to add/remove in/from the favourite list using the ▲/▼ button and select your desired favourite list using the ◀/▶ button and then press the **OK** button.

If you select the channel not added in the selected favourite list, the channel is added in the selected favourite list and the favourite mark of the list appears next to the channel name.

While, if you select the channel added in the selected favourite list, the channel is removed in the selected favourite list and the favourite mark of the list disappears.

You can add a channel to all lists.

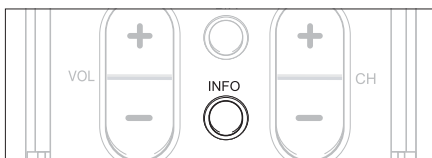

**Note:** To view a help screen for a menu or a function highlighted on **Channel List**, press the **INFO** button. Press the **INFO** button again to close the screen.

## Displaying Information

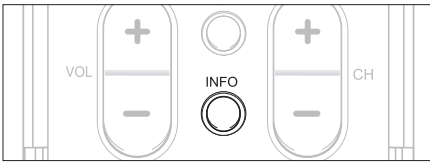

You can view the programme information by pressing the **INFO** button while watching a digital programme.

*Programme information is available only for digital channels*



- 1 Channel list group (All, TV, Radio or Favourite)
- 2 Channel number
- 3 Channel name
- 4 Current time
- 5 Programme broadcasting time
- 6 Programme name
- 7 Icons

	Displayed when the channel supports teletext (MHEG).
	Displayed only when there is any teletext information.
	Displayed only when the radio channel is broadcasted.
	Displayed only when the channel is broadcast in stereo sound.
	Displayed only when the channel is a scrambled channel.
	Displayed only when subtitle information is available.
	Displayed only when the compressed bitstream audio signal is broadcasted.



**Note :** To view the detailed information of the programme, go to the **Electronic Programme Guide (EPG)** by pressing the **GUIDE** button. If detailed programme information is provided, programme information is displayed. Refer **Chapter 4. Using the Electronic Programme Guide (EPG)**.

### Simple Information

Regardless of input signal modes, simple information such as the channel number (or input signal mode), channel name and current time is always displayed for 2 seconds whenever you switch channels or input signal modes.

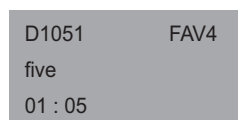

▲ Digital TV Input

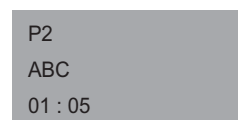

▲ Analog TV Input

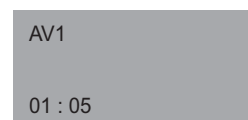

▲ External Input



## Displaying Digital Teletext (MHEG) (for the digital channels only)

If your chosen channel has teletext (MHEG) features, you can access them. Teletext services often load automatically shortly after the Digital Teletext window is displayed. In which case, simply follow the given instructions (press colour buttons).

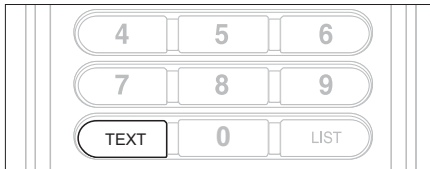

- 1 Press **TEXT** button to access teletext(MHEG) features.
- 2 Press **TEXT** button again to return to normal viewing.
- 3 Press the **CH+/-** button to exit this service.

**Note:** You should select **Off** from the subtitle language to display teletext(MHEG).

## Changing Subtitle Language (for the digital channels only)

If the current programme provides Subtitle information, you can select the language for the Subtitle.



- 1 Press the **SUBTITLE** button to display the subtitle language list.
- 2 Select your desired subtitle language by pressing the **SUBTITLE** button repeatedly. Then the subtitle will be displayed in the selected language at the bottom of the screen.
- 3 Select **OFF** from the subtitle language list if you do not wish to display subtitles in the screen.

## Changing Audio Options

If the current programme is available in multiple audio languages, you can select the language that you wish to listen in.



- 1 Press the **SOUNDTRACK** button to display soundtrack list.
- 2 While watching the analog channels, select **Stereo** or **Mono** by pressing the **SOUNDTRACK** button repeatedly.
- 3 While watching the digital channels, select your desired audio language by pressing the **SOUNDTRACK** button repeatedly.

The Electronic Programme Guide (EPG) displays listings of the previous and next programmes for all digital channels, based on the date and time.

*Electronic Programme Guide (EPG) is available only for digital channels.*

**Note:** Press the **EXIT** button to exit the EPG screen.

## Viewing the Electronic Programme Guide (EPG)

You can view programme listings for all digital channels.

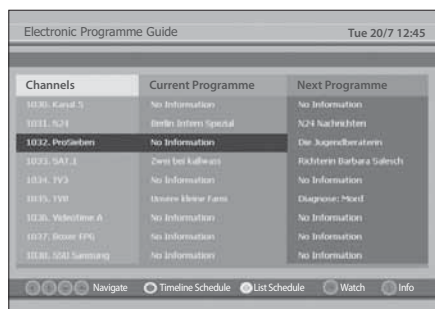

- 1 Press the **GUIDE** button while watching a TV programme. The Electronic Programme Guide (EPG) appears.
- 2 Use the **▲/▼/◀/▶** buttons to move through listings.
- 3 To tune to a programme that is on now, select the programme and press the **OK** button.
- 4 Press the **INFO** button in the selected programme to view the detailed information (if available) of the selected programme. Press the **INFO** button again to hide the information box.
- 5 Press the **EXIT** button to return to Live TV.

### Viewing by Timeline

You can view the programme listings by timeline.

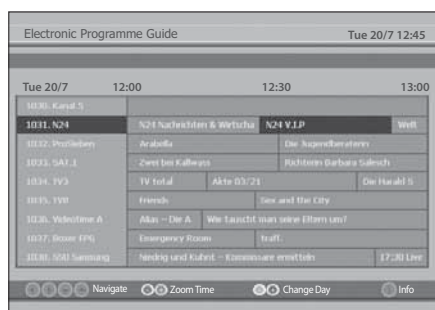

- 1 Press the **GUIDE** button.
- 2 Press the **RED** button to display the schedule by timeline.
- 3 Use the **▲/▼/◀/▶** buttons to move through listings.
- 4 Press the **RED** or **GREEN** button to zoom down or up time. Zoom down time by pressing the **RED** button and zoom up by pressing the **GREEN** button. You can zoom down or up time at intervals of 15 minutes from 15 minutes up to an hour and 30 minutes.
- 5 Press the **YELLOW** or **BLUE** button to move back or forward in day. Move back to one day before by pressing the **YELLOW** button and move forwards in one day ahead by pressing the **BLUE** button.
- 6 Press the **INFO** button in the selected programme to view the detailed information (if available) of the selected programme. Press the **INFO** button again to hide the information box.
- 7 Press the **EXIT** button to return to the previous menu.



## Viewing by Programme List

You can view the programme listings of a particular day and time.

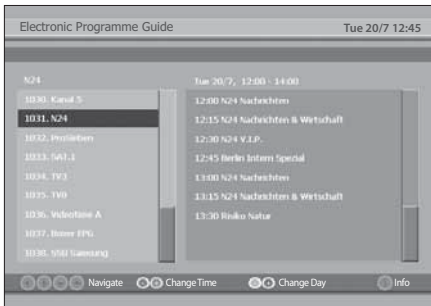
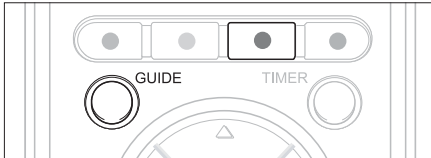

- 1 Press the **GUIDE** button.
- 2 Press the **YELLOW** button to display the schedule by programme list.
- 3 Use the **▲/▼/◀/▶** buttons to move through listings.
- 4 Press the **RED** or **GREEN** button to move back or forward in time. Move back to 2 hours before by pressing the **RED** button and move forwards in 2 hours ahead by pressing the **GREEN** button. You can move back up to one day before and move forward infinitely.
- 5 Press the **YELLOW** or **BLUE** button to move back or forward in day. Move back to one day before by pressing the **YELLOW** button and move forwards in one day ahead by pressing the **BLUE** button repeatedly.
- 6 Press the **INFO** button in the selected programme to view the detailed information (if available) of the selected programme. Press the **INFO** button again to hide the information box.
- 7 Press the **EXIT** button to return to the previous menu.



## Selecting the Picture Mode

You can select the picture mode which best fits your viewing requirements.

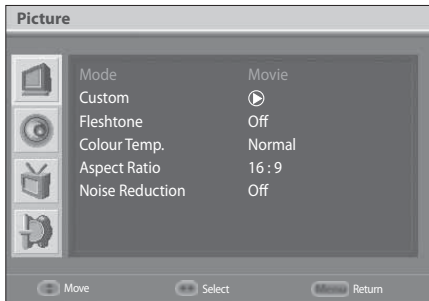

- 1 Press the **MENU** button.
- 2 Select **Picture** using the ▲/▼ button and press the ► button.
- 3 Select the required picture mode using the ◀/▶ button.  
The following options are available:
  - **Custom**  
Select **Custom** to set detailed options such as Brightness, Contrast, and Colour so on.
  - **Movie**  
Select **Movie** to lessen eye strain when watching a movie in a dark place.
  - **Dynamic**  
Increases the clarity and sharpness of the picture.
  - **Mild**  
Softens display with moderate sharpness of the picture.
  - **Standard**  
Shows the optimal sharpness of the picture if viewed in a well-lighted room.
- 4 Press the **EXIT** button to return to Live TV or press the **MENU** button to return to the previous menu.

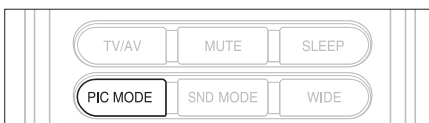

**Note:** You can select a picture mode by simply pressing the **PIC MODE** button on the remote control. Press again to switch.

## Customizing the Picture Settings

You can adjust the picture appearance to suit your preference and viewing situations.

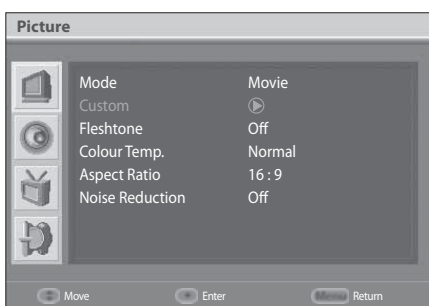

- 1 Press the **MENU** button.
- 2 Select **Picture** using the ▲/▼ button and press the ► button.
- 3 Select **Custom** using the ▲/▼ button and press the ► button.
- 4 Select the required option using the ▲/▼ button.  
The following options are available:  
**Brightness > Contrast > Colour > Sharpness > Tint**
- 5 Press the ◀/▶ button until you reach the optimal setting.  
To select other options, repeat the steps from 4 to 5.
- 6 Press the **EXIT** button to return to Live TV or press the **MENU** button to return to the previous menu.

**Note:** If you make any changes to the options, the picture mode is automatically switched to **Custom**. The **Colour** and **Sharpness** menus are not available in the PC input mode. The **Tint** menu is available in NTSC signal only.



## Fleshtone

Use Fleshtone function to improve the picture quality by adjusting colour balance.

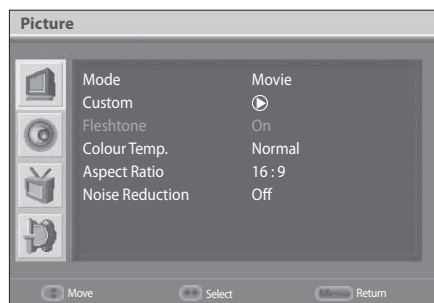

- 1 Press the **MENU** button.
- 2 Select **Picture** using the ▲/▼ button and press the ► button.
- 3 Select **Fleshtone** using the ▲/▼ button.
- 4 Select **On/Off** using the ◀/▶ button.
- 5 Press the **EXIT** button to return to Live TV or press the **MENU** button to return to the previous menu.

## Colour Temperature

You can change the colour of the entire screen to fit your needs. Set to **Warm** for intensifying hot colours such as red, or set to **Cool** for displaying less intense colours with more blue.

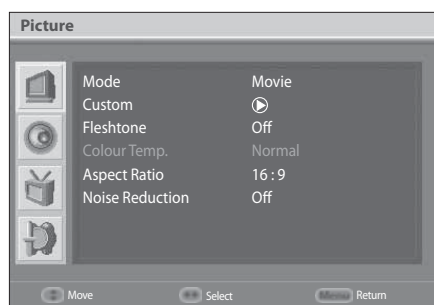

- 1 Press the **MENU** button.
- 2 Select **Picture** using the ▲/▼ button and press the ► button.
- 3 Select **Colour Temp.** using the ▲/▼ button.
- 4 Select the required colour temperature using the ◀/▶ button.  
The following options are available:  
**Warm > Cool > Normal**
- 5 Press the **EXIT** button to return to Live TV or press the **MENU** button to return to the previous menu.

## Setting the Aspect Ratio

You can change the aspect ratio of the screen which best corresponds to your viewing requirements.

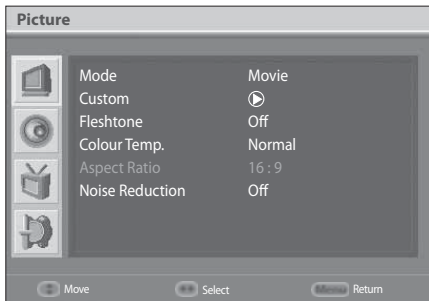

- 1 Press the **MENU** button.
- 2 Select **Picture** using the ▲/▼ button and press the ► button.
- 3 Select **Aspect Ratio** using the ▲/▼ button.
- 4 Select the aspect ratio of your choice by pressing the ◀/▶ button.  
**Auto > 4:3 > 16:9**
- 5 Press the **EXIT** button to return to Live TV or press the **MENU** button to return to the previous menu.

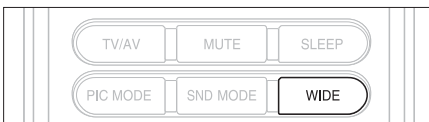

### Notes:

1. You can select the modes by simply pressing the **WIDE** button on the remote control.
2. It is not available in the Component, or PC input mode.

### Auto

Displays the picture as the original aspect ratio of the signal you received.



### 4:3

Displays the picture in the 4:3 ratio.



### 16:9

Displays the picture in the 16:9 ratio. The black bars appear on top and bottom.



## Noise Reduction

If the signal received by your television is weak, you can activate this feature to help reduce noise that may appear on the screen.

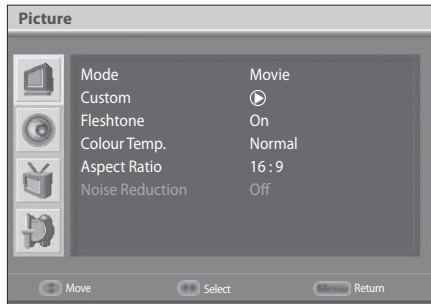

- 1 Press the **MENU** button.
- 2 Select **Picture** using the ▲/▼ button and press the ► button.
- 3 Select **Noise Reduction** using the ▲/▼ button.
- 4 Select the required option by pressing the ◀/▶ button.  
The following options are available.  
**Off > Low > Mid > High > Auto**
- 5 Press the **EXIT** button to return to Live TV or press the **MENU** button to return to the previous menu.

## Setting the Sound Mode

You can select the sound mode to be used when watching a broadcasting programme.

*Sound Mode lets you enjoy the best sound without any special adjustment because the TV sets the appropriate sound options based on the programme content.*

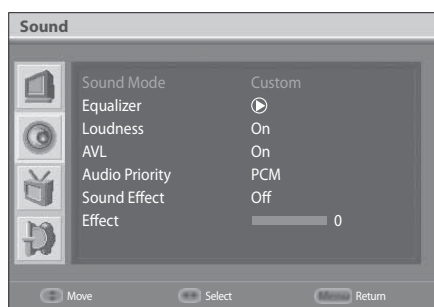

- 1 Press the **MENU** button.
- 2 Select **Sound** using the ▲/▼ button and press the ► button.
- 3 Select the required sound mode using the ◀/▶ button. The following options are available:
  - **Custom**  
Customise your own sound by changing detailed options such as equalizer, loudness and sound effect.
  - **Speech**  
Emphasises clear dialogue.
  - **Movie**  
Emphasises bass tones.
  - **Music**  
Enhances music quality.

- 4 Press the **EXIT** button to return to Live TV or press the **MENU** button to return to the previous menu.

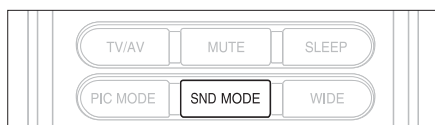

**Note:** You can select sound effect by simply pressing the **SND MODE** button on the remote control. Press again to switch.

## Customizing the Sound Settings

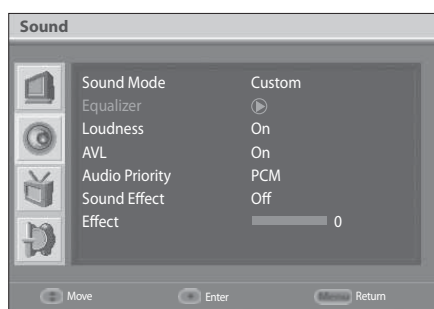

This TV has several options that allow you to control the sound quality.

- 1 Press the **MENU** button.
- 2 Select **Sound** using the ▲/▼ button and press the ► button.
- 3 Select **Equalizer** using the ▲/▼ button and press the ► button.
- 4 Select the required option using the ◀/▶ button and press the ▲/▼ button until you reach the optimal setting.
- 5 Press the **EXIT** button to return to Live TV or press the **MENU** button to return to the previous menu.

**Note:** If you make any changes to the options, the sound mode is automatically switched to **Custom**.

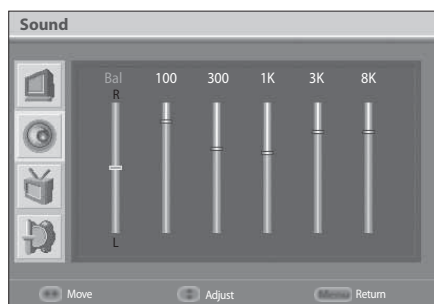



## Setting the Loudness

This feature allows you to improve the perceived sound quality at low volume level.

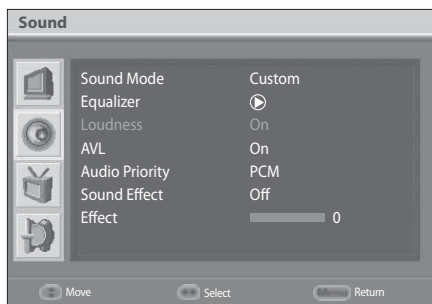

- 1 Press the **MENU** button.
- 2 Select **Sound** using the ▲/▼ button and press the ► button.
- 3 Select **Loudness** using the ▲/▼ button.
- 4 Select **On/Off** using the ◀/▶ button.
- 5 Press the **EXIT** button to return to Live TV or press the **MENU** button to return to the previous menu.

## Adjusting the Volume Automatically

Each broadcasting station has its own signal conditions, volume may not be adjusted each time you switch channels. This feature lets you automatically adjust the volume of the selected channel by adjusting the sound output depending on the signal modulation.

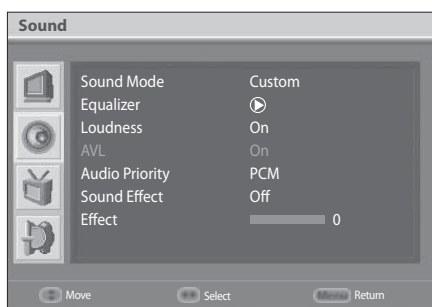

- 1 Press the **MENU** button.
- 2 Select **Sound** using the ▲/▼ button and press the ► button.
- 3 Select **AVL** using the ▲/▼ button.
- 4 Select **On/Off** using the ◀/▶ button.
- 5 Press the **EXIT** button to return to Live TV or press the **MENU** button to return to the previous menu.

## Setting up Audio Priority (for the digital channels only)

You can fully enjoy the Compressed bitstream sound effect with the optical output connected to an external digital audio decoder.

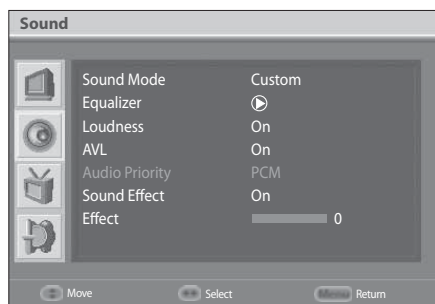

- 1 Press the **MENU** button.
- 2 Select **Sound** using the ▲/▼ button and press the ► button.
- 3 Select **Audio Priority** using the ▲/▼ button.
- 4 Select either **PCM** or **Compressed** by pressing the ◀/▶ button.

### PCM

Converts to PCM(2CH) 48kHz audio. Select **PCM** if your amplifier system is stereo and/or Dolby Pro-logic.

### Compressed

Outputs bit streams (original format) such as Dolby or DTS. Select bitstream if your amplifier system has multi-channel digital audio surround decoding (Dolby Digital and/or DTS).

- 5 Press the **EXIT** button to return to Live TV or press the **MENU** button to return to the previous menu.

## Setting the Sound Effect

The sound effect can be changed to suit your personal preferences.

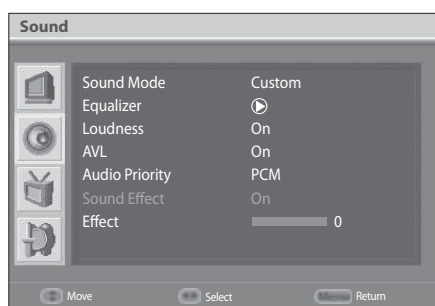

- 1 Press the **MENU** button.
- 2 Select **Sound** using the ▲/▼ button and press the ► button.
- 3 Select **Sound Effect** using the ▲/▼ button.
- 4 Select the required option by pressing the ◀/▶ button.  
The following options are available.  
**Off** > **EPS** (Extended Pseudo Stereo) or **ESS** (Extended Spatial Stereo)
- 5 Press the **EXIT** button to return to Live TV or press the **MENU** button to return to the previous menu.



## Setting the Current Time Information

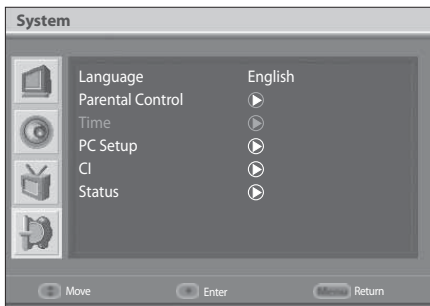

You can set the current time. If you want to set time for automatically turning on/off the power, you must set the local time first.

- 1 Press the **MENU** button.
- 2 Select **System** using the ▲/▼ button and press the ► button.
- 3 Select **Time** using the ▲/▼ button and press the ► button.

**Note :** You can access the **Time** menu by simply pressing the **TIMER** button on the remote control.

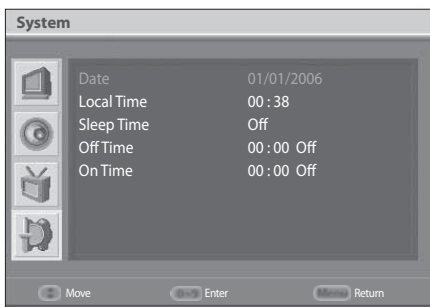
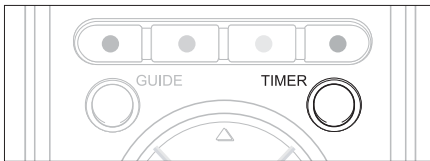

### Setting the Current Date and Time

- 4 Select **Date** using the ▲/▼ button and enter day/month/year using the **NUMBER (0~9)** buttons.
- 5 Select **Local Time** using the ▲/▼ button and enter hour/minute using the **NUMBER (0~9)** buttons.

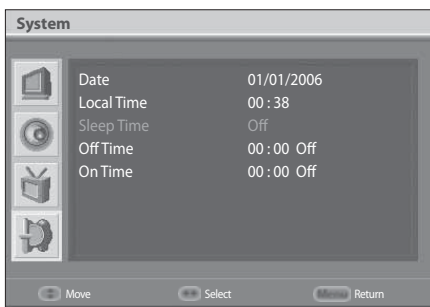

### Setting the Sleep Time

You can turn the TV off at the preset time.

- 4 Select **Sleep Time** using the ▲/▼ button and press the ◀/▶ button to select the preset time internal as follows.  
**Off > 30 > 60 > 90 > 120 > 150 > 180** (minutes)  
When the selected time is out, the TV will be turned off automatically.

**Note :** You can select the sleep time by simply pressing the **SLEEP** button on the remote control.

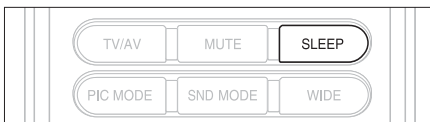

### Using the TV Timer Function

You can schedule time for automatically turning on/off the power so that your TV will automatically be turned on and off at specific time you have scheduled.

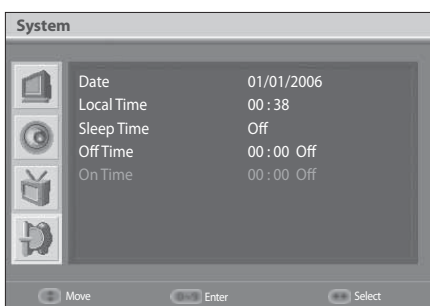

- 4 To set time for turning on the power, select **On Time** using the ▲/▼ button and press the ◀/▶ button to select **On**.
- 5 **On Time** is enabled, set hour/minute pressing the **NUMBER (0~9)** buttons.
- 6 To set time for turning off the power, select **Off Time** using the ▲/▼ button and press the ◀/▶ button to select **On**.
- 7 **Off Time** is enabled, set hour/minute pressing the **NUMBER (0~9)** buttons.



## Parental Control

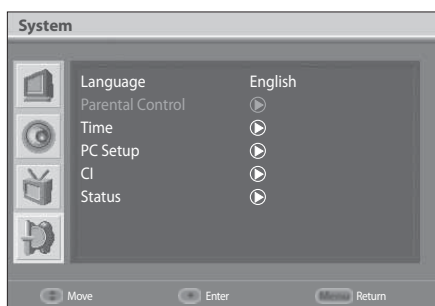

This feature enables you to prevent unauthorised users such as children from watching adult channels or programmes by using a password you have defined.

- 1 Press the **MENU** button.
- 2 Select **System** using the ▲/▼ button and press the ► button.
- 3 Select **Parental Control** using the ▲/▼ button and press the ► button.
- 4 Password is required to access the **Parental Control** menu. Enter your password using the **NUMBER (0~9)** buttons.

### Setting the Child Lock

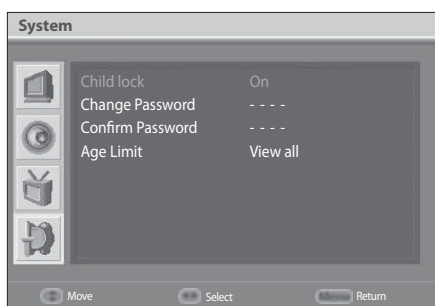

Child Lock enables you can to prevent the children from watching unsuitable programmes.

- 5 Select the **Child lock** using the ▲/▼ button.
- 6 Select **On/Off** using the ◀/▶ button.

**Note :** If you select **On**, TV is locked and the password is required when turning on your TV.

### Changing the Password

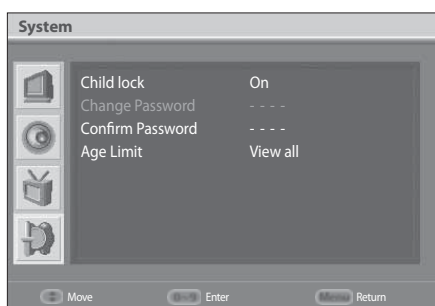

You can change the current password to a new one.

- 5 Select **Change Password** using the ▲/▼ button.
- 6 Enter your new password using the **NUMBER (0~9)** buttons.
- 7 Enter the new password again to confirm. Then your new password has been memorized.

**Note:** The Default Password is "0000". If you have forgotten your password, please contact your local TV distributor.

### Setting the Age Limit (for the digital channels only)

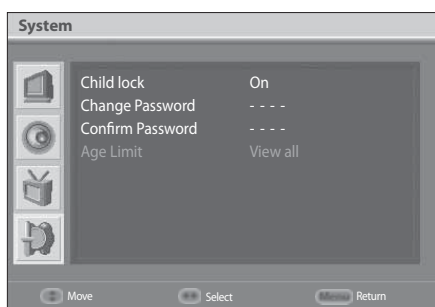

**Age Limit** enables you to block programmes from unauthorised users according to the age level you have defined.

- 5 Select the **Age limit** using the ▲/▼ button.
- 6 Define ages for unauthorised users not to access to blocked programmes using the ◀/▶ button.

**View All :** All programmes are not blocked.

**7, 12, 15, 18 :** Programmes is blocked for age groups under each age.

#### Notes:

1. You have to enter the password to watch the blocked programmes by the age restriction.
2. This function is available only for the programmes with the age information.



## Common Interface (for the digital channels only)

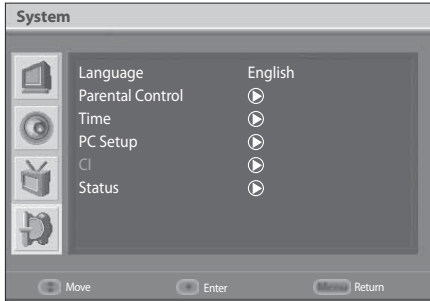

You can view the current status of the CI module. The **CI** sub menu displays when inserting the CI module to the TV.

- 1 Press the **MENU** button.
- 2 Select **System** using the ▲/▼ button and press the ► button.
- 3 Select **CI(Common Interface)** using the ▲/▼ button and press the ► button.
- 4 If Common Interface is available, you can view information about Slot.
- 5 Press the **EXIT** button to return to Live TV or press the **MENU** button to return to the previous menu.

---

**Note:** The displayed information about each Common Interface may differ depending on the type of Common Interface.

---

## Status

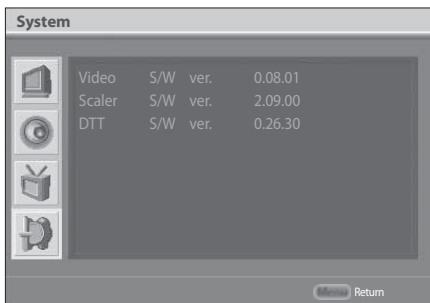

You can view the system information.

- 1 Press the **MENU** button.
- 2 Select **System** using the ▲/▼ button and press the ► button.
- 3 Select **Status** using the ▲/▼ button and press the ► button.
- 4 Confirm the information about Video S/W version, Scaler S/W version, and DTT S/W version.
- 5 Press the **EXIT** button to return to Live TV or press the **MENU** button to return to the previous menu.

## Displaying Teletext information

You can view teletext information at any time on your TV. Most of TV broadcasting stations provide text information services via teletext. The index page of the teletext service gives you information on how to use the service. You can also select various options to fit your needs using the buttons on your remote control.

**Note:** To properly display teletext information, channel reception must be stable. Otherwise, information may be missing or some pages may not be displayed.

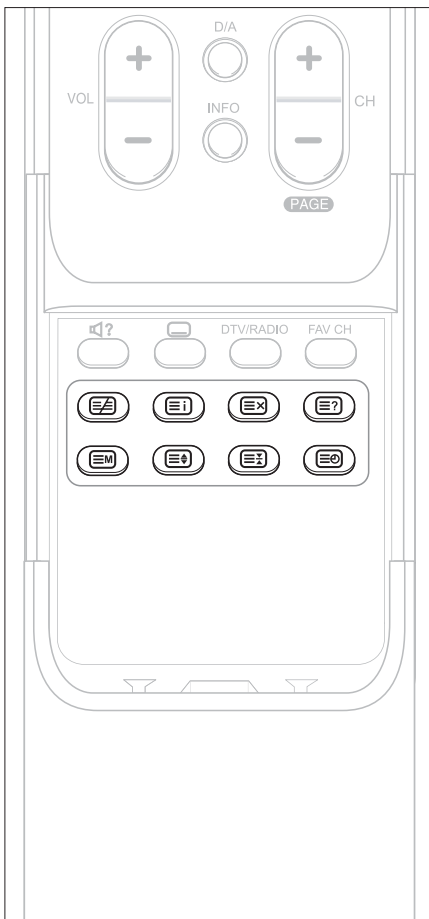

TELETEXT related buttons are as shown below:

 **(Teletext On/Mix/Off)**

A first press activates the teletext service and a second press overlaps the teletext with the broadcasting screen. Pressing for the third time deactivates the teletext service.

 **(Index)**

Displays the teletext index page.

 **(Cancel)**

Displays TV programmes when searching for the new teletext page.

 **(Reveal)**

Shows the hidden information. (answers to quiz games, for example)  
Press it again to return to normal display.

 **(Mode)**

Selects the teletext mode (LIST/FLOF)

 **(Size)**

Displays the double-size letters for lower half of the screen, press it again to return to normal display.

 **(Hold)**

Holds the display on a given page if the selected page is linked with several secondary pages that automatically follow. To resume, press it again.

 **(Time)**

When watching TV programmes, press it to display the time at the top right hand corner of the screen.

**Number (0~9)**

Press to enter the three-digit page number given in the content.

**Coloured buttons (Red/Green/Yellow/Blue)**

If the FASTEXT system is used by a broadcasting company, the different topics covered on a teletext page are colour-coded and can be selected by pressing the coloured buttons. Press one of them according to your needs. The page is displayed with other coloured information that can be selected in the same way. To display the previous or next page, press the corresponding coloured button.

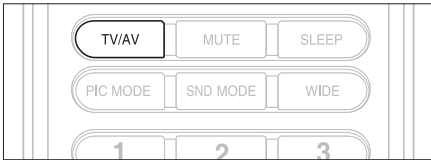
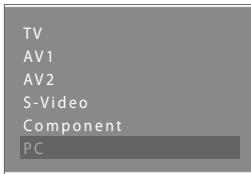

The **PC Setup** menu shows in the PC input mode only when connecting the PC.

- 1 Press the **TV/AV** button to switch to **PC** mode.
- 2 Select **PC** using the **▲/▼** button and press the **OK** button.
- 3 Press the **MENU** button.
- 4 Select **System** using the **▲/▼** button and press the **▶** button.
- 5 Select **PC Setup** using the **▲/▼** button and press the **▶** button.

## Auto Configure

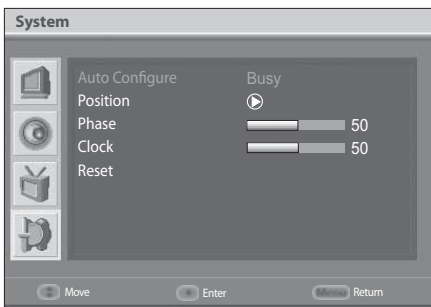

Automatically optimizes the display. This is recommended for the first time connecting to a PC.

- 6 Select **Auto Configure** using the **▲/▼** button and press the **◀** or **▶** button. The picture quality and position are automatically adjusted with optimal value, and the picture returns to original view about a few seconds later.

## Position

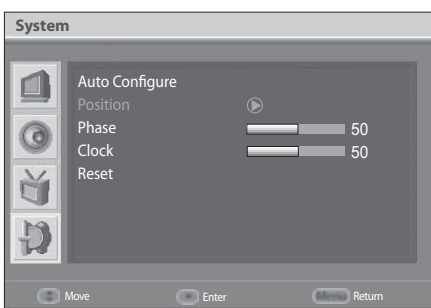

Adjusts the display position to PC if it does not fit the TV screen.

- 6 Select **Position** using the **▲/▼** button and press the **▶** button.
- 7 Select **Horizontal/Vertical** using the **▲/▼** button and adjust the position using the **◀/▶** button.

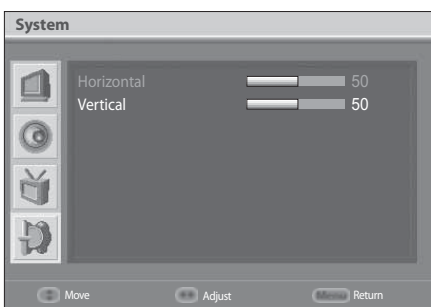

## Phase

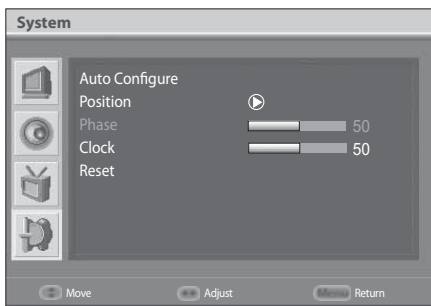

Sets the focus of screen.

- 6 Select **Phase** using the ▲/▼ button.
- 7 Adjust the optimal focus using the ◀/▶ button.

## Clock

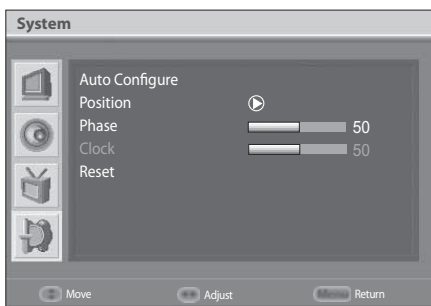

Adjusts the horizontal feature of screen by increasing or decreasing the number of pixels.

- 6 Select **Clock** using the ▲/▼ button.
- 7 Adjust the optimal horizontal feature using the ◀/▶ button.

## Reset

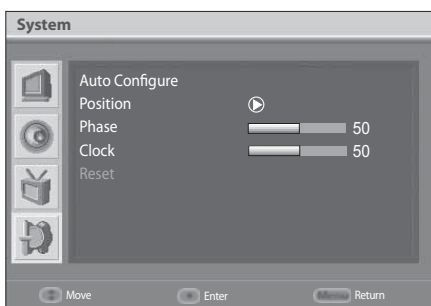

Sets the PC settings to the default setting values.

- 6 Select **Reset** using the ▲/▼ button.
- 7 Press the ◀ or ▶ button to change all settings value of PC screen to the factory default.





---

**Note:** If noise is present, change the PC mode to another resolution, change the refresh rate to another rate until the picture is clear. If the refresh rate of the PC graphic card can not be changed, change the PC graphic card or consult the manufacturer of the PC graphic card.

---



# Menu Structure

	Picture	<ul style="list-style-type: none"> <li>- Mode</li> <li>- Custom</li> <li>- Fleshtone</li> <li>- Colour Temp.</li> <li>- Aspect Ratio</li> <li>- Noise Reduction</li> </ul>
	Sound	<ul style="list-style-type: none"> <li>- Sound Mode</li> <li>- Equalizer</li> <li>- Loudness</li> <li>- AVL</li> <li>- Audio Priority ----- (for the digital channels only)</li> <li>- Sound Effect</li> <li>- Effect</li> </ul>
	Channel	<ul style="list-style-type: none"> <li>- Country</li> <li>- Auto Search</li> <li>- Manual Search</li> <li>- Edit Programmes ----- (for the analog channels only)</li> </ul>
	System	<ul style="list-style-type: none"> <li>- Language</li> <li>- Parental Control</li> <li>- Time</li> <li>- PC Setup ----- (PC mode only)</li> <li>- CI ----- (for the digital channels only)</li> <li>- Status</li> </ul>

## Troubleshooting

Before contacting your local service dealer, please make sure you refer to the following guide. If the TV does not work normally after completing the following trouble shooting, please contact your local TV distributor or service centre.

- (1) No message is displayed on the front panel or the TV has no power.
  - Check the main power cable and make sure it is plugged into a suitable power outlet.
  - Check that the mains supply is switched on.
  - Check that the power switch is on at the side of the TV (where applicable)
- (2) No picture
  - Make sure that the TV is power on and in operation mode (press STANDBY button).
  - Make sure that the AV cable is firmly connected to the TV. You may need to remove the cable from both ends and reconnect.
  - Make sure that the antenna line is properly connected to the TV.
  - Check the brightness level of the TV.
  - Check if the channel is currently on air. Contact the broadcaster to ensure that the channel is running.
- (3) Poor picture & sound quality
  - Install the antenna in an obstacle-free place.
  - Make sure there is no mobile phone or microwave oven near the TV.
  - Use 75 coaxial cable when connecting TV and antenna.
- (4) No or poor sound
  - Check that your AV cable is connected correctly.
  - Check the volume levels of your TV.
  - Check if the TV is on mute.
  - Check audio type or soundtrack option in the AV menu.
- (5) Remote Control does not operate.
  - To control the TV, the top end of the remote control should point directly towards the receiving part of the TV.
  - Remove and reinsert the batteries in the remote control.
  - Replace the batteries in the remote control for a new set.
- (6) Cannot watch scrambled channel.
  - Check that you have the appropriate Smartcard or CAM. Reinsert the Smartcard or CAM and make sure it initializes correctly.
  - Check in the menu that the TV is detecting the Smartcard or CAM.
  - Check in the menu that you have a valid and working subscription to the channels you wish to view.
  - Ensure that the Smartcard or CAM is not damaged.



## Specification

Item		Specification	
LCD Panel	Type	Colour active matrix TFT-LCD	
	Display Area	20.1"	
	Max. Resolution	640x480 pixels	
	Viewing Angle	R/L : 170 , U/D : 170 (CR ≥10)	
PC Monitor	Sync	Separate	
	Horizontal Frequency	31~48kHz	
	Vertical Frequency	56~60Hz	
	Max. Resolution	1024 x 768 pixels@ 60Hz	
Input/Output	Video Input	Analog/Digital Tuner (1), SCART (1), RCA, RGB, S-Video, Component (480i/480p/576i/576p/720p/1080i)	
	Audio Input	PC Audio, Component (R/L), RCA (R/L)	
	Audio Output	S/PDIF, Speaker, Headphone	
	Data Interface	RS-232C (for SW update)	
TV Signal		<b>Analogue</b>	<b>Digital</b>
	Area	EU	EU(MHEG)
	Antenna Input	IEC 169-2 Female	IEC 169-2 Female
	Tuning System	FS	OFDM DVB-T
	Colour System	PAL, SECAM	-
	Sound System	B/G, D/K, I, L	-
	Video Decoding	-	MPEG-2 MP@ML
	Audio Decoding	-	MPEG/MusiCam Layer I / II
	Stereo/Bilingual	NICAM/A2	NICAM/A2
	VHF/UHF	48.25 ~ 855.25 MHz	48.25 ~ 855.25 MHz
Teletext	Yes	Yes	
Regulation	Safety	CE	
	EMI	CE	
Others	Power	65W (Max.)	
	Speaker Output	2W + 2W	
	Plug & Play Level	DDC 1/2 B	
	Weight	NET 9.6 kg / Gross 11.5 kg	
	Power Supply	AC 100V ~240V, 50/60 Hz	
	Operating Temperature	5°C ~ 35°C	
	Operating Humidity	30 ~ 80% RH	



## Service and Support

You can get information such as a troubleshooting guide, software upgrades and product support guide from the following web sites and call center (Hotline). Please try to contact to your local dealers first when facing a problem.

### Web site and e-mail

#### Homepage

<a href="http://www.humaxdigital.com">http://www.humaxdigital.com</a>	English
<a href="http://www.humaxdigital.com/Deutsch/">http://www.humaxdigital.com/Deutsch/</a>	Deutsch
<a href="http://www.humaxarabia.com">http://www.humaxarabia.com</a>	Arabic

#### HCSA (Humax Customer Service Area)

Software Download, Information and Technical Q&A

<a href="http://www.humaxdigital.com/hcsa/">http://www.humaxdigital.com/hcsa/</a>	English
<a href="http://www.humaxdigital.com/Deutsch/hcsa/">http://www.humaxdigital.com/Deutsch/hcsa/</a>	Deutsch

#### E-mail (Technical Q&A)

<a href="mailto:tech-info@humax-digital.co.uk">tech-info@humax-digital.co.uk</a>	Europe & North Africa
<a href="mailto:techinfo@humax-digital.de">techinfo@humax-digital.de</a>	Germany
<a href="mailto:callcenterME@humaxdigital.com">callcenterME@humaxdigital.com</a>	Middle East
<a href="mailto:Webmaster@humaxdigital.com">Webmaster@humaxdigital.com</a>	Asia & Other area



### Call Center

#### Humax Customer Helpline (UK)

**Tel:** 0870 247 8800

**E-mail:** [uksupport@humax-digital.co.uk](mailto:uksupport@humax-digital.co.uk)

**Open:** Local Time in UK (GMT+0), 08:30 – 18:00 (Monday -Friday)

**Support Language:** English

#### Humax Middle East Call Center (Dubai, UAE)

**Tel:** +971 (0)4 359 2323 (Open: 09:00 - 20:00 / close on Friday)

**E-mail:** [callcenterME@humaxdigital.com](mailto:callcenterME@humaxdigital.com)

**Open:** Local Time in Dubai (GMT+4), 09:00 - 20:00 (Saturday - Thursday, close on Friday)

**Support Language:** English/Arabic

#### Humax Hotline (Germany)

**Germany:** 01805 778 900 ( € 0,12/Min)

**Other Countries:** + 49 1805 778 870 ( € 0,12/Min+ International Call Charge)

**E-mail:** [support@humax-digital.de](mailto:support@humax-digital.de)

**Open:** Local Time in Germany (GMT+1), 08:00 - 23:00 (Monday - Sunday)

**Support Language:** Deutsch/English

#### HUMAX Hotline (Italy)

**Tel :** 899 100080

**E-mail :** [info@mediasat.com](mailto:info@mediasat.com)

**Open :** Local Time in Italy (GMT+1), 08:00~18:00 (Monday - Friday)

**Support Language :** Italian

#### HUMAX Hotline (Austria)

**Tel :** 0820 400675 ( € 0,12/min.)

#### HUMAX Hotline (Sweden)

**Tel :** +46 (0)550 85527

**Open :** 08:00 ~ 16:30 (Monday - Friday)

**Support Language :** Swedish/English

#### HUMAX Hotline (Finland)

**Tel :** 09 5618 6366

**Open :** 08:00 ~ 16:00 (Monday - Friday)

**Support Language :** Finnish/English

*For hardware repair, please refer to website. (Homepage or HCSA)*