

HITACHI

17LD4220

Gebruiksaanwijzing **NL**

Instructions for use **GB**

Instruktionsbog **DK**

Bedienungsanleitung **D**



HITACHI

Contents

Remote Control Buttons	35	PC MODE	55
Control Panel Buttons	36	Installation	55
Preparation	37	Switching from TV to PC	55
Installation of the TFT TV to the wall ..	37	Main Menu in PC mode:	55
Features	39	Sound Menu	56
Panel Features	39	Picture Menu	56
Safety Precautions	39	PIP Picture	56
Before Switching on your TV	42	Feature Menu:	56
Power connection	42	Geometry Menu:	57
Connections to the Aerial socket	42	Source Menu:	57
How to connect other devices	42	PIP Source Menu:	57
Inserting batteries in the remote control handset	42	Teletext	57
Switching the TV ON/OFF	42	To operate Teletext	57
To switch the TV on	42	To select a page of Teletext	58
To switch the TV off	43	To Select Index Page	58
Operating the TV	43	To Select Double Height Text	58
A.P.S. (Automatic Programming System)	43	To Reveal "concealed" Information	58
Operating with the buttons on the TV set	43	To Stop Automatic Page Change	58
Operating with Remote Control	43	To Select a Subpage	58
Menu System	44	Fastext	59
Sound Menu	45	To exit Teletext	59
Picture Menu	47	To Display the Time	59
Feature Menu	49	Peripheral Equipment Connections	59
Installation Menu	50	PC Sound Connection	59
Programme Menu	51	Via the Euroconnector	59
Source Menu	53	Via Aerial Input	59
Other Features	53	Peripheral Equipment Connections	60
TV Status	53	AERIAL Connections	61
Programme Swap (P<P)	53	Peripheral Equipment Connections	61
Double-digit (- / - -)	54	Decoder	62
Personal Preferences (PP)	54	TV and Video Recorder	62
Sound Indicator	54	Playback NTSC	62
Picture Mode	54	Search for and store the test signal of the video recorder	62
Sleep Timer Indicator	54	Camera and Camcorder	62
Mute Indicator	54	Connect the decoder to the video recorder	62
No-Signal Detection (TV)	55	Connecting Headphones	62
No-Signal Detection (PC)	55	Connecting the PC	62
Volume Bar	55	PC INPUT TYPICAL DISPLAY MODES ...	63
AV Modes	55	Tips	64
Signal Out Of Range	55	Specifications	65

Remote Control Buttons

- ① = Stand By
- ② = Cursor Up
- ③ = Cursor Right
- ④ **OK** = Store
- ⑤ = Info (Program Menu)
- ⑥ **0 - 9** = Direct Program
- ⑦ = Double Digit
- ⑧ **P<P** = Previous Programme
- ⑨ **P/CH +** = Programme Up
- ⑩ = Volume +
- ⑪ = TV / Quit Menu
- ⑫ = External Source
(AV-1, AV-2, AV-3, S-VIDEO, PC)
- ⑬ **Yellow (FEATURE)** = Feature Menu
- ⑭ **Blue (INSTALL)** = Installation Menu
- ⑮ = Hold
- ⑯ = Update
- ⑰ = Index Page
- ⑱ = Reveal, **PC** = Switch from TV to PC
- ⑲ = Expand, = Aspect ratio
- ⑳ = PIP on / PIP off
- ㉑ = Teletext
- ㉒ = Time
- ㉓ **Red (SOUND)** = Sound Menu
- ㉔ **Green (PICTURE)** = Picture Menu
- ㉕ = Mute
- ㉖ **I-II** = Mono/Stereo - Dual I-II
- ㉗ = Volume -
- ㉘ **- P/CH** = Programme Down
- ㉙ **PP** = Personal Preference
- ㉚ **M** = Menu
- ㉛ = Cursor Down
- ㉜ = Cursor Left

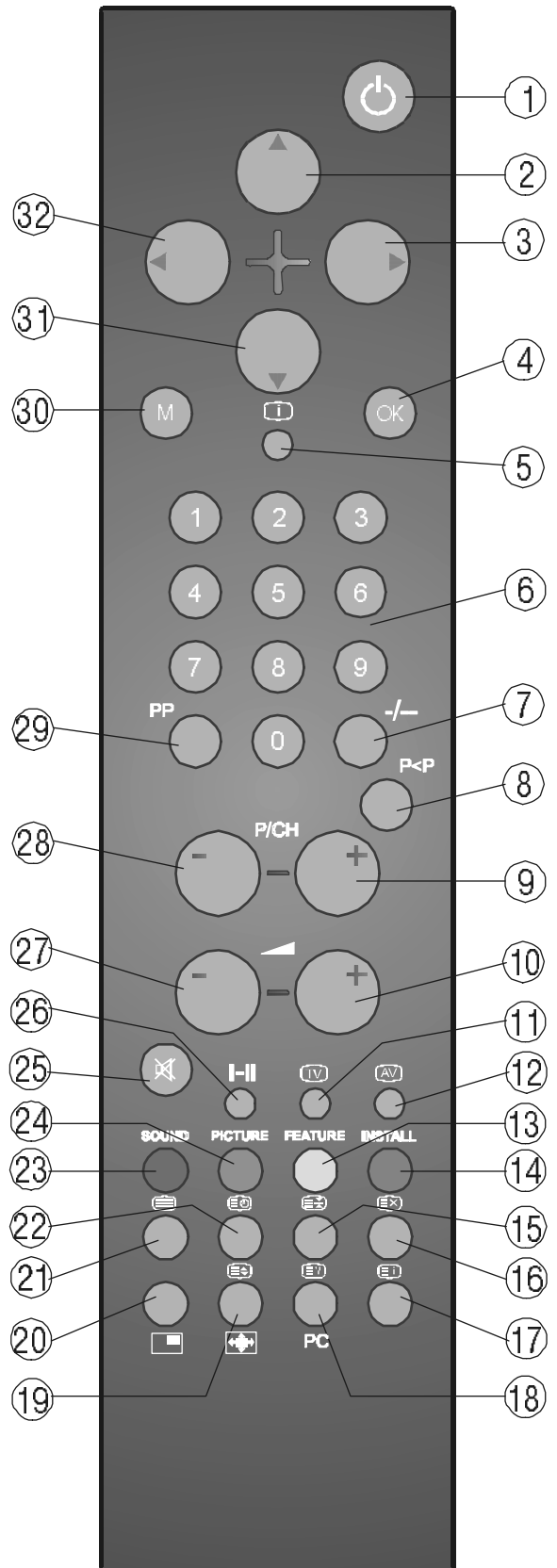

Control Panel Buttons

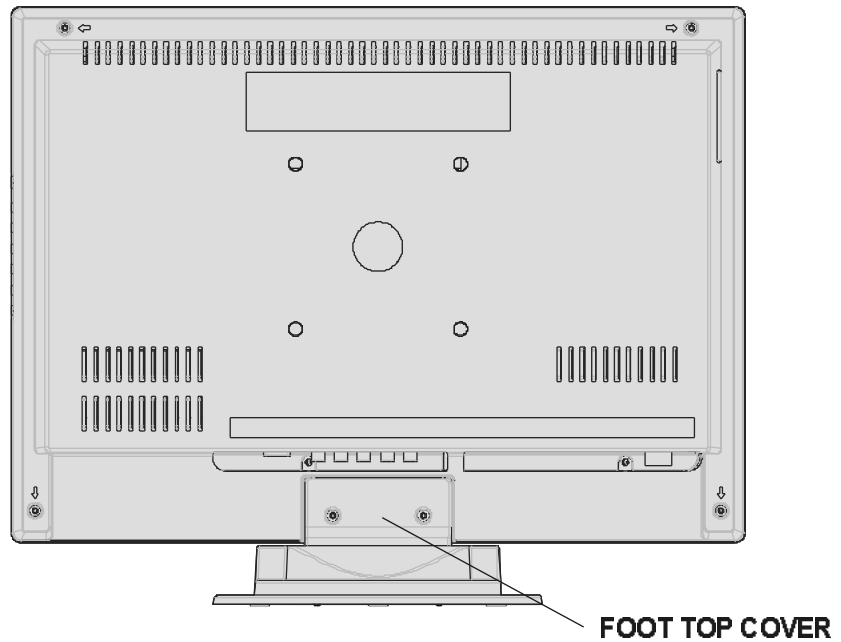
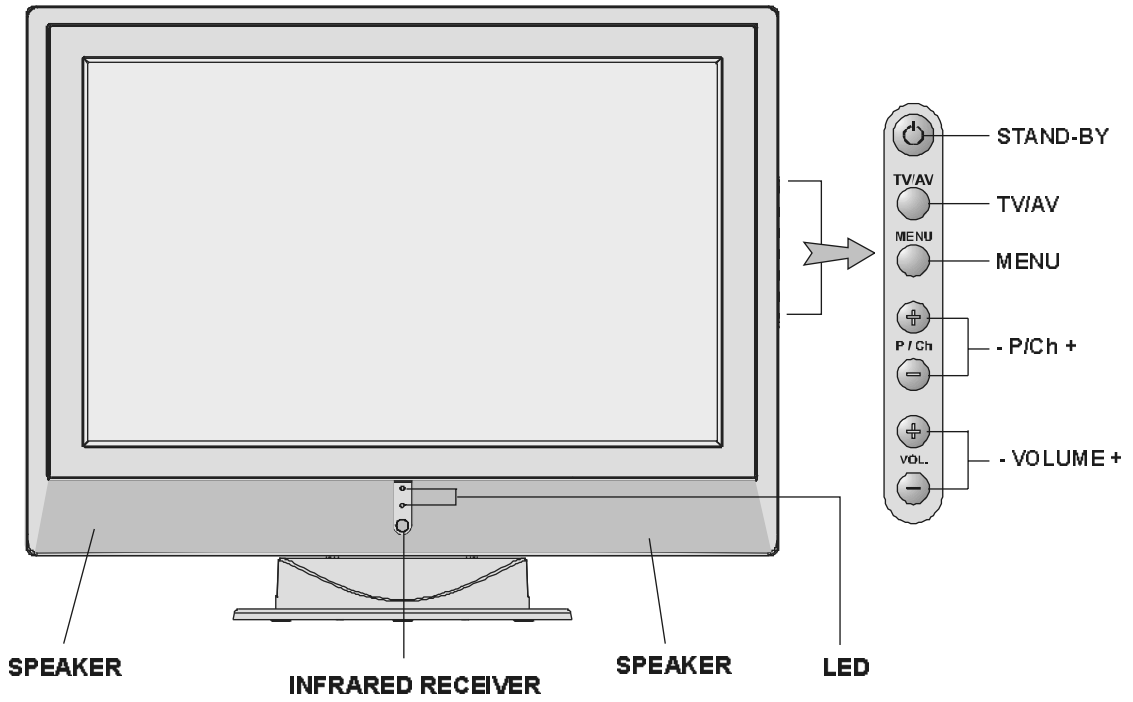

Preparation

Install Display on solid horizontal surface such as a table or desk.

For ventilation, leave a space of at least 10 cm free all around the set. To prevent any fault and unsafe situations, please do not place any objects on top of the set.

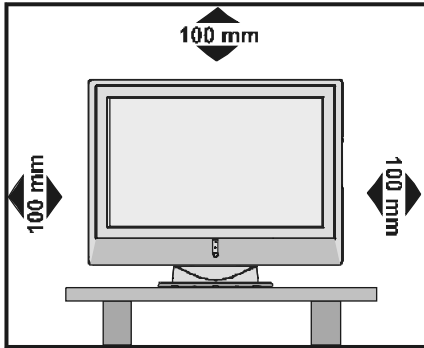

This apparatus can be used in tropical and/or moderate climates.

Installation of the TFT TV to the wall

- 1-** To install the TFT TV on the wall, first of all, foot assembly should be removed. Unscrew the 2 screws that attach the foot top cover and the 4 screws that attach the foot to the TFT panel and remove the foot assembly from the TFT panel.
- 2-** Place the 4 hangers to the circular screw holes at the rear of the TFT and screw them to the TFT panel with 4 (M4 x 10) screws.
- 3-** Decide the place on the wall where the TFT panel would be placed. Level and mark with a pencil the 4 mounting points on the wall hanger. Drill pilot holes for the plastic anchors and then fix the wall hanger with 4 screws (M4 x 30).
- 4-** Raise the TFT panel and hang it to the holes on the wall bracket from the 4 hanging screws at the rear of the TFT panel.

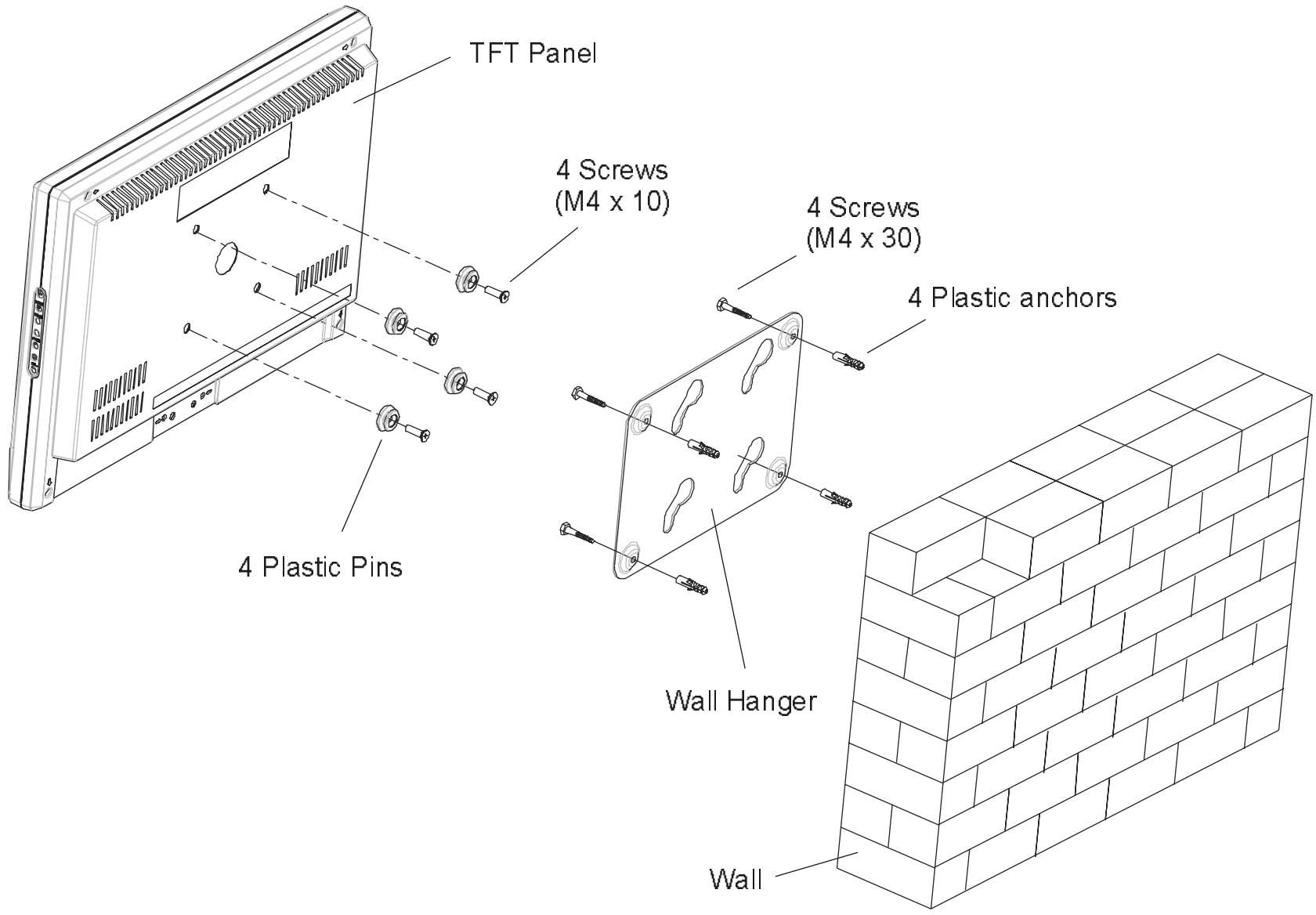

Features

- It is a remote controlled colour television and PC monitor.
- 100 programmes from VHF, UHF bands or cable channels can be preset.
- It can tune cable channels.
- Controlling the TV is very easy by its menu driven system.
- It has 2 pieces of Euroconnector socket for external devices (such as video, video games, audio set, etc.)
- To use as a monitor, 15 Pin Mini D-Sub connector for computer.
- A2 German stereo and Nicam stereo systems.
- Multilanguage OSD.
- Teletext (Fastext (7 pages)).
- It is possible to connect headphone.
- A.P.S. (Automatic programming system)
- All programmes can be named.
- Programme swapping between last two programmes watched
- Forward or backward automatic tuning.
- Sleep timer.
- Child lock
- Auto, 4:3, 16:9, Cinema, Subtitle, Zoom and Panorama modes.
- Automatic sound mute when no transmission.
- When no valid signal is detected, after 5 minutes the TV switches itself automatically to stand-by mode.
- NTSC Playback.
- Universal power supply range is a standard feature on this model.
- TV Picture in PC (if PC input available).
- PLL (Channel Search)
- PC input (Support Up to 1280 x 768)

Panel Features

- High resolution (1280 x 768), 17"-inch TFT LCD display.
- High contrast ratio (400:1 Typical)
- Brightness: 450 cd/m².
- High-speed response time < 25 msec.
- Wide viewing angle (typical) 140° (horizontal) and 110° (vertical).
- 8-bit colour depth, display 16.2 M colours.

Safety Precautions

IMPORTANT SAFETY INFORMATION ON OPERATING YOUR TV

Do's and Don'ts

DO's

This Television has been designed and manufactured to meet international safety standards, but like any electrical equipment, care must be taken if you are to obtain the best results and safety is to be assured.

DO read the operating instructions before you attempt to use the equipment.

DO consult your dealer if you are in any doubt about installation, operation or safety of your equipment.

DO be careful with glass panels or doors on equipment.

This TV is supplied with a fitted mains plug. This plug must not be cut off as it may contain a special radio interference filter, the removal of which could lead to impaired performance. If you wish to extend the lead, obtain an appropriate safety approved extension lead or consult your dealer.

Observe the manufacturers instructions when connecting extension leads to the TV. Check the fuse rating on the new plug, this should be fitted with a 5 Amp fuse which conforms to either ASTA or BSI (BS1 362) approvals, these are easily identifiable by either the

the  or  symbols. If you are in

any doubt about the installation of an extension lead, please consult a competent electrician.

DON'Ts

DON'T continue to operate the equipment if you are in any doubt about it working normally, or if it is damaged in any way switch off, withdraw the mains plug and consult your dealer.

DON'T place water filled vessels on top of T.V. cabinets.

DON'T remove any fixed cover as this may expose dangerous voltages.

DON'T leave equipment switched on when it is unattended unless it is specifically stated that it is designed for unattended operation or has a stand-by mode. Switch off using the switch on the equipment and make sure your family know how to do this. Special arrangements may need to be made for infirm or handicapped people.

DON'T use equipment such as personal stereos or radios so that you are distracted from the requirements of traffic safety. It is illegal to watch television whilst driving.

DON'T obstruct the ventilation of the equipment, for example with curtains or soft furnishings. Overheating will cause damage and shorten the life of the equipment.

DON'T use makeshift stands and **NEVER** fix legs or stands to the TV with any screws other than those provided - to ensure complete safety always use the manufacturers approved stand with the fixings provided.

DON'T allow electrical equipment to be exposed to rain or moisture.

ABOVE ALL

- ***NEVER let anyone, especially children push anything into holes, slots or any other opening in the case - this could result in a fatal electric shock.***
- ***NEVER guess or take chances with electrical equipment of any kind - it is better to be safe than sorry!***

1. Power Source

The TV set is designed to operate on **12 V DC**. The adaptor should be operated from a **220-240V AC, 50 Hz.** outlet. Ensure you select the correct voltage setting for your convenience.

2. Power Cord

The power supply cord should be placed so that it is not likely to be walked on or pinched by items placed upon them or against it. Pay particular attention to cord where it enters the plug, power outlet, and the point where it exits from the receiver.

3. Moisture and Water

Do not use this equipment in a humid and damp place (avoid the bathroom, the sink in the kitchen, and near the washing machine). Do not expose this equipment to rain or water, as this may be dangerous and do not place objects filled with liquids on top. Avoid from dripping or splashing.

4. Cleaning

Before cleaning, unplug the adaptor from the main supply, outlet. Do not use liquid or aerosol cleaners. Use soft and dry cloth.

5. Ventilation

The slots and openings on the receiver are intended for ventilation and to ensure reliable operation. To prevent overheating, these openings must not be blocked or covered in anyway.

6. Lightning

In case of storm and lightning or when going on holiday, disconnect the power cord from the wall outlet.

7. Replacement Part

When replacement parts are required, be sure the service technician has used replacement parts which are specified by the manufacturer or have the same specifications as the original one. Unauthorised substitutions may result in fire, electrical shock, or other hazards.

8. Servicing

Please refer all servicing to qualified personnel. Do not remove cover as this may result in electric shock.

9. Naked Flame Sources

Do not place naked flame sources on the apparatus.

WARNING: When the device is not in use for a long time, disconnect from power.

Instructions for waste disposal:

- Packaging and packaging aids are recyclable and should principally be recycled. Packaging materials, such as foil bag, must be kept away from children.
- Battery, including those which is heavy metal-free, should not be disposed of with household waste. Please dispose of used battery in an environmentally sound manner. Find out about the legal regulations which apply in your area.
- Cold cathode fluorescent lamp in LCD PANEL contains a small amount of mercury, please follow local ordinances or regulations for disposal.

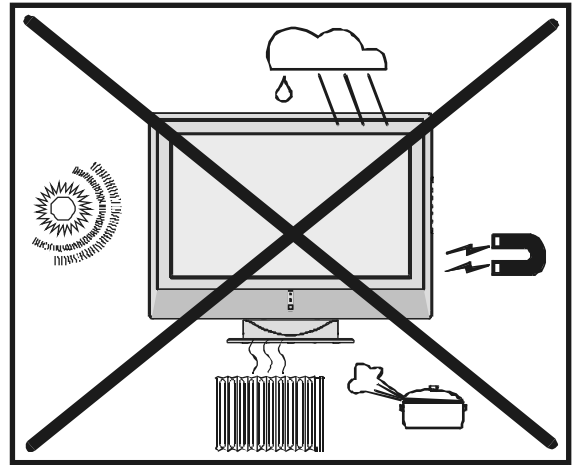

“DO NOT LEAVE YOUR TV AT STAND-BY OR OPERATING WHEN YOU LEAVE YOUR HOUSE”

"The LCD panel is very high technology product with about a million thin film transistors, giving you fine picture details. Occasionally, a few non-active pixels may appear on the screen as a fixed point of blue, green or red. Please note that this does not affect the performance of your product."

" The mains plug of the power supply is used as disconnect device and therefore shall remain readily operable. "

“DO use the power cord given/supplied by the manufacturer for the AC adaptor of the product”.

Before Switching on your TV

Power connection

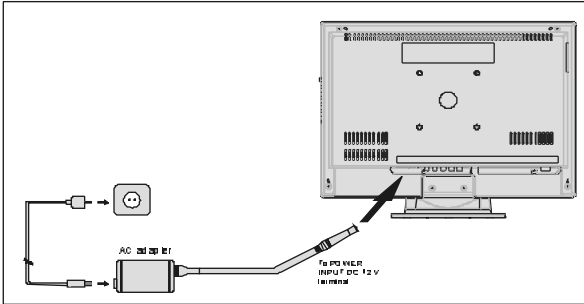

IMPORTANT: The TV set is designed to operate on 12 V DC. For this, an adaptor is used which gives 12V DC voltage. Connect this adaptor to a system that supplies 220-240V AC, 50 Hz.

- After unpacking, allow the TV set to reach the ambient room temperature before you connect the set to the mains.

Connections to the Aerial socket

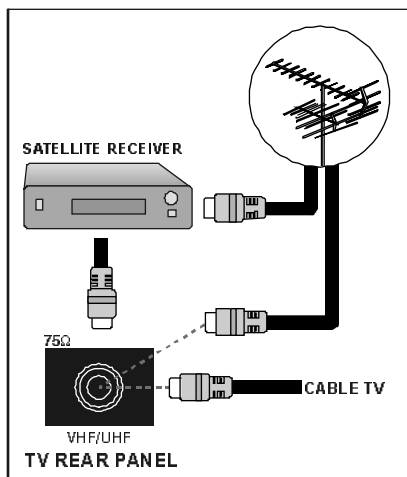

- Connect the aerial or cable TV plug to the aerial socket on the back of the TV. If you are also connecting a video recorder or satellite receiver you should connect the aerial or cable plug to this device first and then connect the RF out socket on the device to the aerial socket on the TV.

How to connect other devices

IMPORTANT: Switch off the TV before connecting any external device.

Sockets for external connections are at the back of the TV. For connection of other de-

vices via Euroconnector refer to the manuals of the related devices.

Inserting batteries in the remote control handset

- Remove the battery cover located on the back of the handset by gently pulling upwards from the indicated part.
- Insert two AAA (R03) or equivalent type of batteries inside.
- Replace the battery cover.

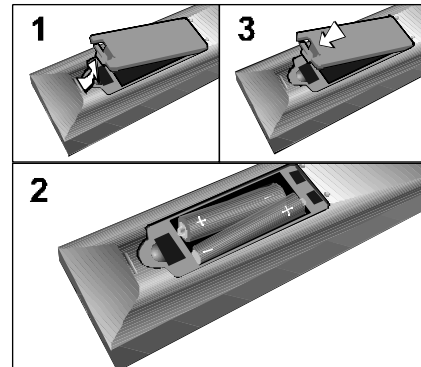

NOTE: Remove the batteries from remote control handset when it is not to be used for a long period. Otherwise it can be damaged due to any leakage of battery.

Switching the TV ON/OFF

To switch the TV on

Your TV will switch on in two steps:

- 1- Connect the power supply cord to the sys-

tem. Press the “” button on the right side of the TV. Then the TV switches itself to stand-by mode and the led, located on the front of the TV, becomes red.

- 2- To switch on the TV from stand-by mode either:

Press the “” button on the remote control, or,

Press a digit button on the remote control so that a programme number is selected,

or,

Press “P/Ch” button on the right side of the TV or press “-P/CH” or “P/CH+” buttons on the remote control, so that last switched off programme is selected.

In either case the TV will switch on and diminishes the brightness of the led.

To switch the TV off

NOTE: To switch the TV off completely remove the mains plug from the socket.

- Press the “” button on the remote control, so the TV will switch to stand-by mode and the **GREEN LED** will become **RED**,

or,







Press the “” button located on the right side of the TV, so the TV will switch off and the **GREEN LED** will turn off.

Operating the TV

You can operate your TV both using the remote control handset and onset buttons.

A.P.S. (Automatic Programming System)

"All Prestored Programmes Will Be Erased" message will be displayed when you turn your TV on for the first time. APS, searches and sorts all channels and stores them automatically on your TV, according to the transmission of programme systems in your area.

To cancel APS before starting, press “” button. First of all choose the “**Country**”. This, will effect the sort process in APS. By pressing the “” or “” button, come to the “**Language**” item and select the language in which the menus of the TV will appear. As soon as you change the language, the menu items will be displayed in the selected language. To select “**Continue**” use “” or “” button and press “” or “” button.

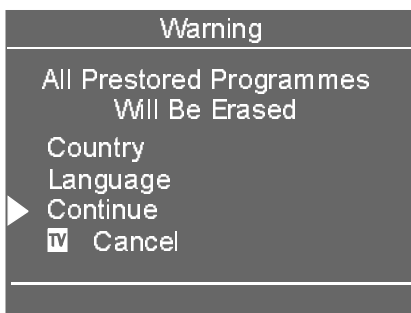

After APS is finalized, a programme list will appear on the screen. In the programme list you will see the programme numbers and names assigned to the programmes.

If you press the “” button at any time while the A.P.S. is running, the A.P.S. will be ended. Then, the program list on the screen will show channels captured until this time.

If you do not accept the locations and / or the programme names of programmes, you can change them in Programme menu.

Operating with the buttons on the TV set

Volume setting and programme selection can be made by using the buttons at the control panel on the right side of the TV.

Volume Setting

- Press “- VOL.” button to decrease volume or “VOL. +” button to increase volume, so a volume level scale (slider) will be displayed at the middle of the bottom on the screen.

Programme Selecting

- Press “P/Ch +” button to select the next programme or “- P/Ch” button to select the previous programme.

Entering Main Menu

- Press “MENU” button to enter Main menu. In the Main menu select submenu using “- P/Ch” or “P/Ch +” button and enter the submenu using “- VOL.” or “VOL. +” button. To learn the usage of the menus, refer to the Menu System section.

Operating with Remote Control

The remote control handset of your TV is designed to control all the functions of the model you selected. The functions will be described in accordance with the menu system of your TV.

Functions of the menu system are described in Menu System section.

Volume Setting

Press “▲ +” button to increase volume. Press “- ▼” button to decrease volume. A volume level scale (slider) will be displayed at the middle of the bottom on the screen.



Programme Selecting

(Previous or next programme)

- Press “-P/CH” button to select the previous programme.
- Press “P/CH+” button to select the next programme.

Programme Selecting (direct access):

Press digit buttons on the remote control handset to select programmes between 0 and 9. TV will switch to the selected programme. To select programmes between 10 - 99, you must use the double digit button “- / - -”.

P - - this OSD is displayed at the left hand upper on the screen.

Press the digit buttons consecutively for the channel you wish to select. (eg for programme 27, first press 2 then 7). If you do not press the second digit within 3 secs of pressing the first, the display will disappear.

Press directly the programme number to reselect single digit programmes.

Programme Swapping

- Press “P<P” (programme swap) button to select the last selected programme. This button provides swapping between last two selected programmes. For example, select

programme 8, then select programme 2. Now, if you press “P<P” button, programme 8 will be selected. If you press the same button again, programme 2 will be selected and so on.



Menu System

Your TV has been designed with a menu system to provide an easy manipulation of a multi-function system. The TV is controlled by choosing the commands, which are displayed on the screen.

Press the “M” button. The main menu will be displayed in the middle of the screen.

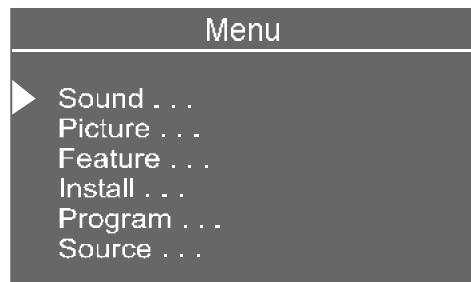

To select a sub-menu use “△” or “▽” button, and press “◀” or “▶” button or directly press “OK” button.

MAIN MENU

The menu system is described below.

The short way in order to enter the menus, press :

"M" Button,	Main Menu.
Red Button,	Sound Menu.
Green Button,	Picture Menu.
Yellow Button,	Feature Menu.
Blue Button,	Install Menu.
"i" Button,	Programme Menu in TV mode or,
	Source Menu In AV mode

Menu button has two functions; first is opening or closing the main menu, and the second is closing the sub-menu and then opening its parent menu.

Menu does not disappear automatically if it is left on the screen.

Press “**TV**” key on the remote control unit to remove menu.

Sound Menu

To change sound settings

- Enter the Sound Menu directly by pressing the Red button or,
- As you enter the main menu, sound will be the first item. In the main menu, select **Sound** using “**△**” or “**▽**” button, then enter the sound menu pressing “**◀**”, “**▶**” or “**OK**” button.

Setting Volume:

As you enter the sound menu, Volume will be the first selected option.

- Press “**▶**” button to increase volume.
- Press “**◀**” button to decrease volume.

Or you can directly change the volume settings using “**▲ +**” (to increase) or “**- ▲**” (to decrease) button.

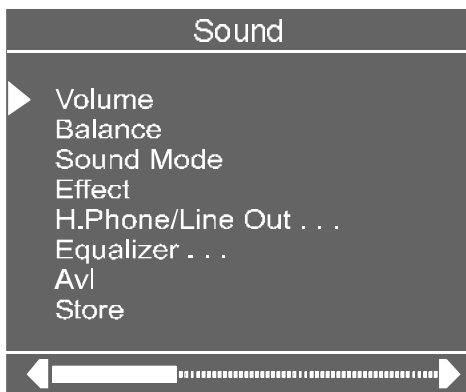

Setting Balance

It allows adjusting the distribution between the left and right speakers.

- Using “**△**” or “**▽**” button select Balance.
- Press “**▶**” button to change balance to the right.

- Press “**◀**” button to change balance to the left.

When balance control is in mid position, the cursor is displayed with one arrow.

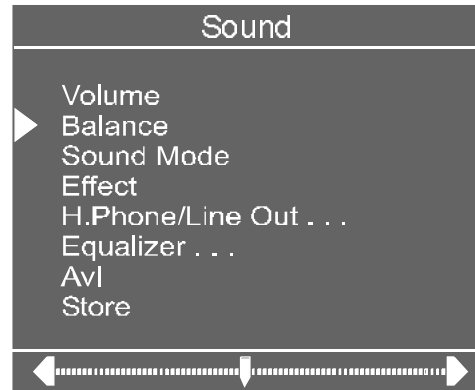

Selecting Sound Mode

- Using “**△**” or “**▽**” button select Sound Mode.
- Press “**◀**” or “**▶**” button to change Sound Mode.

You can choose **Mono**, **Stereo** or **Dual (I-II)** mode, only if the selected channel supports that mode.

You can also change sound mode directly pressing “**I-II**” button on your remote control.



In case of bilingual broadcast (Dual Sound), you can select original or dubbed language using mode option.

Setting Effect

You can use this feature to switch the sound effect on and off. Pressing “**◀**” or “**▶**” button will turn on and off this feature. If the current

sound system is **Mono** and the sound effect is set **ON**, then the sound will be heard as if it is **Stereo**. If the current sound system is **Stereo**, switching this effect on will give a more spatial sound.

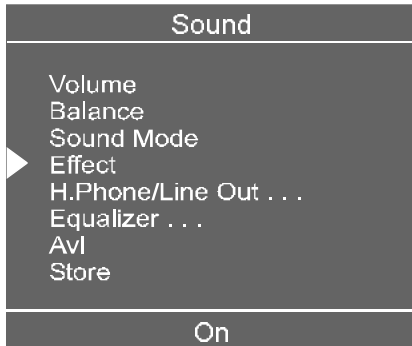

To Change H.Phone/Line Out Settings

- Using “△” or “▽” button select H.Phone/Line Out.
- Press “◀” or “▶” button or directly press “OK” button on **H.Phone/Line Out**, to enter the H.Phone/Line Out menu. This is a sub-menu of Sound menu, and all options in this menu are working as the same in the Sound menu.

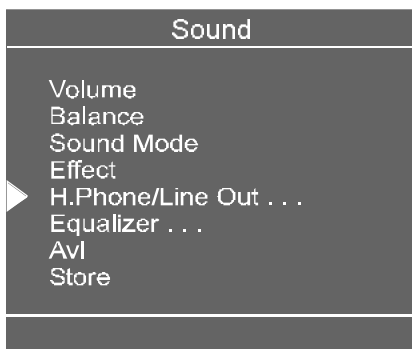

Setting H.Phone/Line Out Volume

- As you enter the H.Phone/Line Out sound menu, Volume will be the first selected option.
- Press “▶” button to increase volume.
- Press “◀” button to decrease volume.

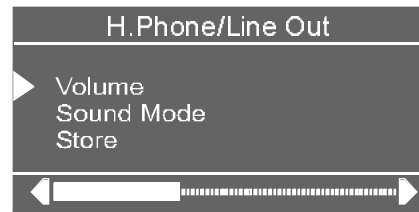

Setting H.Phone/Line Out Sound Mode

- Using “△” or “▽” button select Sound Mode.

Pressing “◀” or “▶” button will change the current sound mode. (e.g.: If the current sound mode is stereo, it will be stereo or visa versa).

In case of bilingual broadcast, you can select original or dubbed language again using mode menu. So when somebody listens to the original language from the loudspeakers, somebody else can listen to the dubbed language from headphone.

To Store the Settings

- Press “OK” button on the remote control to store the settings directly.

or,

- Using “△” or “▽” button select Store. Press “◀”, “▶” or “OK” button to store current H.Phone/Line Out volume and sound mode. The stored values will be valid for all the programmes.

Equalizer

- Using “△” or “▽” button select Equalizer.
- Press “◀” or “▶” button or directly press “OK” button to enter Equalizer sub-menu.

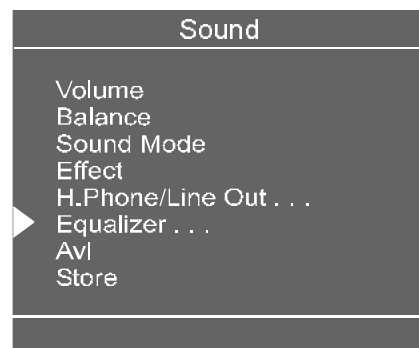

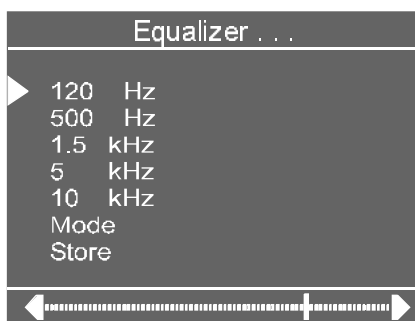

In Mode item there are five predefined and one user defined options. These are User, Classic, Jazz, Rock, Pop and Flat. The predefined options can not be changed by the user. If you want to change one of the frequency values of the predefined options, the Mode must be switched to User option.

The 5 items below the Mode are available to adjust the sound settings in 5 frequency values: 120 Hz, 500 Hz, 1.5 kHz, 5 kHz and 10 kHz. To change the values of 5 frequency options, select one of the options by “△” or “▽” button, and then press “▷” to increase the value, or “◁” to decrease the value. In mid position, cursor is displayed with one arrow.

To store the Equalizer settings, press “◁” or “▷” button or directly press “OK” button on “Store” option.

The settings will be stored and you can recall them by selecting "USER" in the MODE item.

Setting AVL

- Using “△” or “▽” button select AVL.
- Pressing “◁” or “▷” button will turn on and off this feature.

Automatic Volume Limiting (AVL) function normalises sound to obtain fixed output level between programmes, having different sound levels.

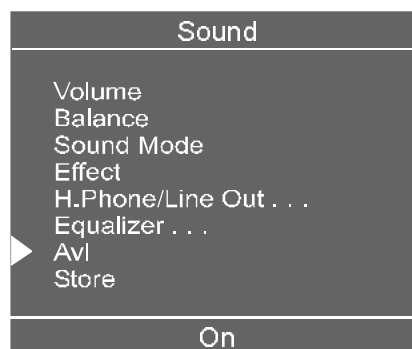

To Store the Settings

- When the cursor is on any item which has no sub-menu press “OK” button on the remote control to store the settings directly.
- or,
- Press “◁”, “▷” or “OK” button on “Store” option to store Sound menu settings.

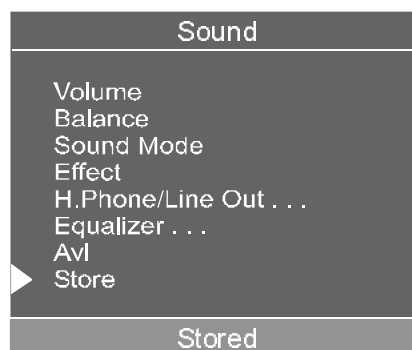

Picture Menu

- To enter the Picture menu directly, press the Green button, or
- Press "M" button, now you are in main menu. In the Main menu, select “Picture” using “△” or “▽” button, then enter the Picture menu pressing “◁” / “▷” or “OK” button.

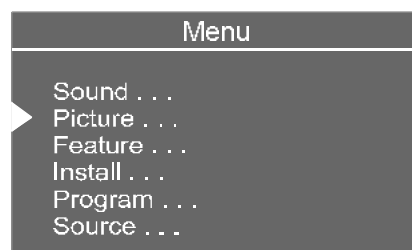

Setting Brightness

- As you enter the picture menu, Brightness will be the first item.

- Press “▷” button to increase brightness.
- Press “◁” button to decrease brightness.

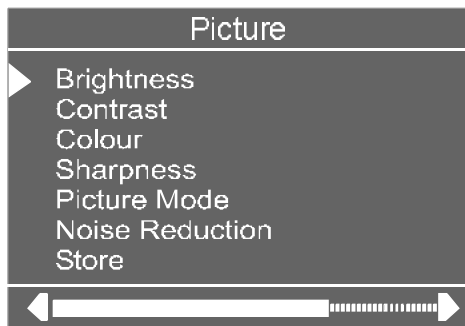

Setting Contrast

- Using “△” or “▽” button select Contrast.
- Press “▷” button to increase contrast level.
- Press “◁” button to decrease contrast level.

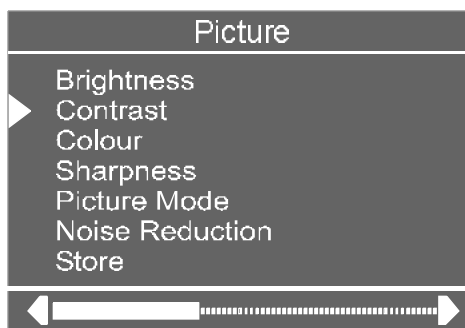

Setting Colour

- Using “△” or “▽” button select Colour.
- Press “▷” button to increase colour level.
- Press “◁” button to decrease colour level.

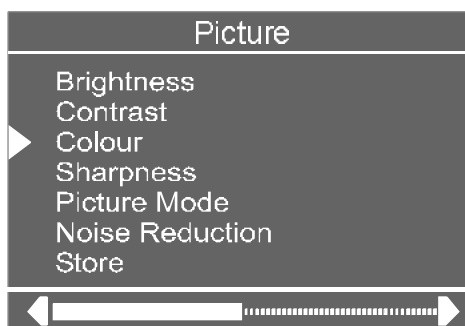

Setting Sharpness

- Using “△” or “▽” button select Sharpness.
- Press “▷” button to increase sharpness level.
- Press “◁” button to decrease sharpness level.

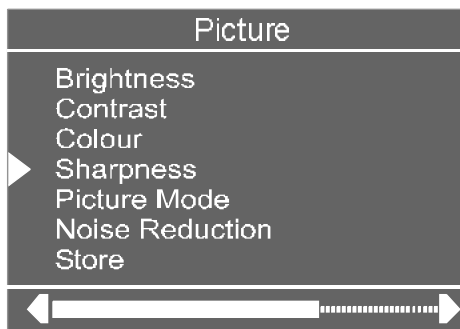

Setting Picture Mode:

- Using “△” or “▽” button select Picture Mode.
- Press “◁” or “▷” button to set Picture Mode. Picture Mode can be set to **Auto**, **4:3**, **16:9**, **Cinema**, **Subtitle**, **Zoom** or **Panorama**.

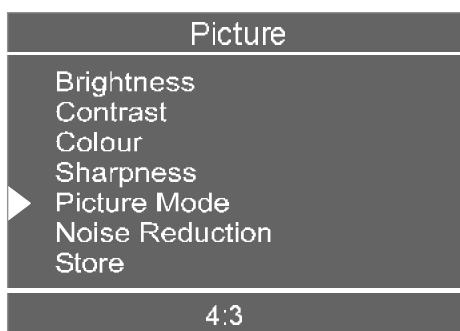

Setting Noise Reduction

- Using “△” or “▽” button select Noise Reduction.
- Press “◁” or “▷” button to select Noise Reduction level “Off” or “Minimum” or “Medium” or “Maximum” then select “store” and press “◁” or “▷” button to save your setting.

Note 1:

At low signal level, changes on the Noise Reduction function are not effective when there is a menu on the screen. If the menu is removed, the effect of this function will be seen. With normal broadcasting, Noise Reduction changes are effective at once.

Note 2:

At moving pictures, while Noise Reduction is at maximum level, some picture distortion may occur. If Noise Reduction is set to medium or minimum, the picture will improve.

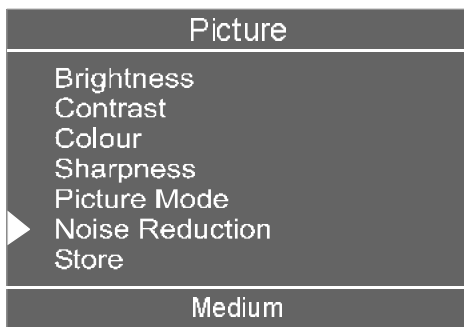

Setting Hue

(During Playback NTSC system, this will appear in AV mode only when NTSC video source is applied. Otherwise, HUE option is invisible in Picture menu.):

- Using “△” or “▽” button select Hue.
- Press “▷” button to increase hue level.
- Press “◁” button to decrease hue level.

Center value is indicated with one arrow.

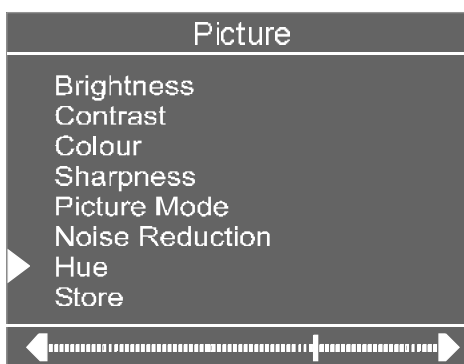

To Store the Settings

- When the cursor is on any item which has no sub-menu press “OK” button on the remote control to store the settings directly.

or,

- Press “◁”, “▷” or “OK” button on **Store** option to store Picture menu settings.

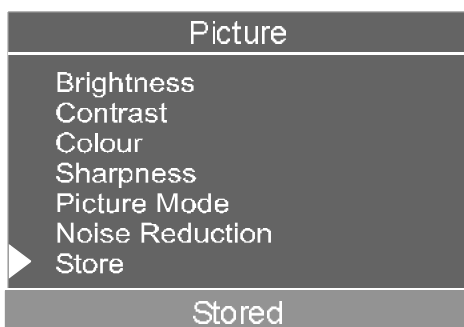

Feature Menu

- To enter the Feature menu directly, press the Yellow button, or
- Press "M" button, now you are in main menu. In the main menu, select **Feature** using “△” or “▽” button. Then enter the Feature menu pressing “◁” / “▷” or “OK” button.

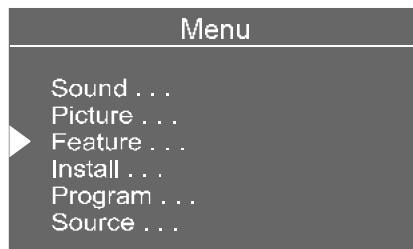

Sleep Timer

As you enter the Feature menu, **Sleep Timer** will be the first selected option. Use “◁” or “▷” button to change the Sleep Timer values between **Off, 0:15, 0:30, 0:45, 1:00, 1:15, 1:30, 1:45** and **2:00**.

If sleep timer is activated it is displayed with the TV status on the upper right of the screen.

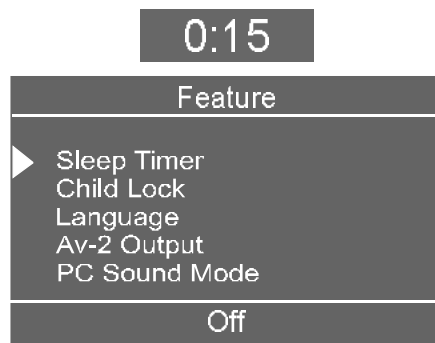

Once the time set with the sleep timer has elapsed, the set will go to standby.

Child Lock

You can use this feature to prevent children turning on/off TV or changing programmes or adjustments etc. without remote control.

The **Child Lock** feature can be set **On** or **Off** by “◁” or “▷” button. When **Off** is selected, there will be no difference in the operation of your TV. When **On** is selected, the TV can only be controlled by the remote control

handset. In this case the control panel buttons except "⏻" button on the right side of the TV will not work.

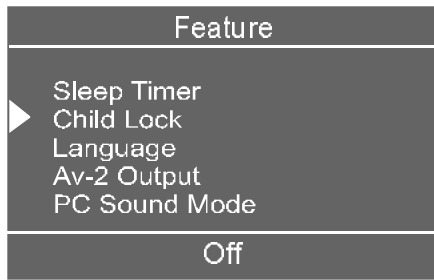

Selecting Menu Language

Menu language can be chosen by pressing "◀" or "▶" button on **Language** item.



Av-2 Output

From Av-2 Output; TV, AV-1 or AV-3 can be given. TV, AV-1 or AV-3 can be chosen by pressing "◀" or "▶" button on "**Av-2 OUTPUT**".

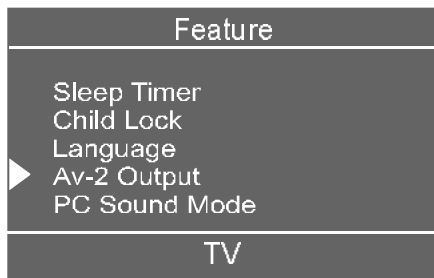

PC Sound Mode

PC sound can be chosen by pressing "◀" or "▶" button on **PC Sound Mode** item.

You can select sound that comes from TV, AV-1, AV-2, AV-3 or PC to hear in PC mode.

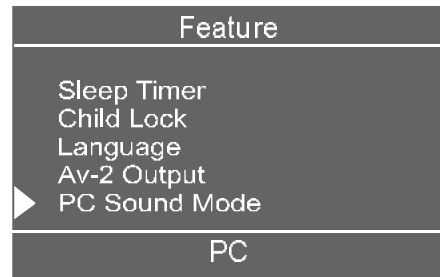

To Store Settings

In Feature menu all settings are stored automatically.

Installation Menu

- To enter the Installation menu directly, press the Blue button, or
- Press "M" button, now you are in main menu. In the main menu, select "**Install.**" using "△" or "▽" button. Then enter the Install menu pressing "◀" / "▶" or "OK" button.

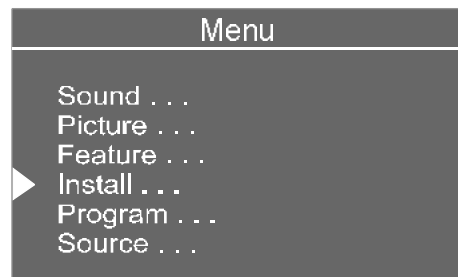

When any item is selected with "△" or "▽" button in the install menu, the selected item will be highlighted on the bottom bar. Changes by pressing "◀" or "▶" button will be result only at highlighted item on the bottom bar.

Selecting Programme

To select programme number, you can use "◀" or "▶" button, Digit Buttons or The Double Digit button with digit buttons.

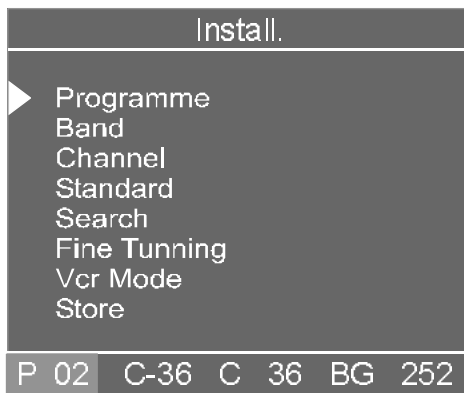

Selecting Band

Band, can be chosen either,

- “C” or “S” by “◀” or “▶” button.

Selecting Channel

Channel can be changed by “◀” or “▶” button, by Digit Buttons or by the Double Digit button with digit buttons.

For band C,

01 - 83, WEST EUROPE.

01 - 76, FRANCE.

For band S,

01 - 41 .

Selecting Standard

Using “◀” or “▶” button on **Standard**, you can change the standard to **B/G, L/L'**.

Selecting Search

To start the search process, press “▶” button for forward search or “◀” button for backward search. If a signal is found or reaches to end of the band after searching, press “◀” or “▶” buttons to continue search process. To stop the search process when you want, press “◀” or “▶” buttons again.

Selecting Fine Tuning

You can use the Fine Tuning process for fine adjustment (after coarse adjustment), if you are not happy about the image on the screen.

Use “◀” or “▶” button on **Fine Tuning** item, until getting the best image on the screen.

Normally the Fine Tuning cursor is placed next to the left side on the slider and this is indicated with one arrow.

Setting VCR (Video Cassette Recorder) Mode

- This item can be seen in **TV, AV-1, AV-2, AV-3, S-VIDEO** modes.
- If you want to watch a **VCR** source from one of these modes, then it will be better to set **VCR** mode “on”. For this, while the cursor is on this item press the “◀” or “▶” buttons to set it “On”.
- If you want to watch a **DVD** , then you must set this item “off”; because **DVD** is not a source like a **VCR** and to see the **best** picture, you must set the **VCR** mode “Off”.

To Store Settings

- Press “**OK**” button on the remote control to store the settings directly.
- or,
- Press “◀”, “▶” or “**OK**” button on **Store** option to store Install menu settings.

Installation menu in AV mode is as follows.

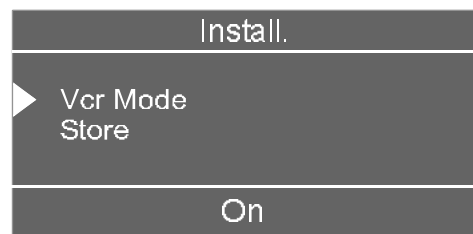

Programme Menu

- To enter Programme menu directly, press the “**i**” button in TV mode, or
- Press “**M**” button, now you are in main menu. In the main menu, select “**Program.**” using “△” or “▽” button. Then enter the Programme menu, press “◀” / “▶” or “**OK**” button.

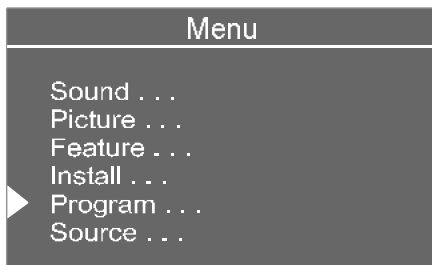

By moving the cursor in four directions, you can reach 20 programmes in the same page. By scrolling the pages up or down by pressing the navigation buttons you can select all the programmes in TV mode (except the AV mode).

By cursor action, programme selection is done automatically. It is also possible to select programme by using digit or double-digit button. In this way programme selection is also automatic. The TV Status is changed by the programme selection too. When using double-digit button in order to select a programme, the Programme Number in TV Status OSD is displayed in "P --" form, and by pressing digit buttons they are displayed in it.

Programme Number is between 00 and 99. Programme Name has a name string with 4 characters. After autostore process the Programme Names are set to:

- Channel search "C-01" or "S-01" (band and channel number) or name of the tuned channel if defined.

Program.		P 02	
01	C-01	11	----
▶02	C-02	12	----
03	C-03	13	----
04	C-04	14	----
05	S-01	15	----
06	S-02	16	----
07	----	17	----
08	----	18	----
09	----	19	----
10	----	20	----
Name		Insert	
Delete		Autostore	

At the bottom of the menu there is a programme sort functions section. Each function is activated by coloured button (seen above). **Name** allows changing the pro-

gramme name. By **Delete** you can delete programmes that you do not require. **Insert** section is for inserting programmes into another programme spaces. By selecting **Autostore** section, Autostore menu will be available.

Name:

To change the name of a programme, select the programme and then press the RED (Name) button. The first letter begins to blink on the selected name. To change that letter "△" or "▽" button can be used, and to select the other letters, "◀" or "▶" button can be used. If the cursor is at the last letter of the Programme Name, pressing "▶" button moves the cursor to the beginning. On the contrary, if the cursor is at the beginning of the Programme Name, pressing "◀" button moves the cursor to the end.

After changing the name press the RED (Store) button. After activating the name process the "Insert", "Delete" and "Autostore" processes will be inactive and "Cancel" option will be valid. If you do want to store the new name, press the BLUE (Cancel) button.



Insert:

When the Green (Insert) button is pressed, "Name", "Autostore" and "Delete" functions are erased, the selected programme (A) is displayed with an arrow. From now on, the automatic selection is cancelled. With navigation buttons, the decided programme space (B) can be selected and by pressing the green button again the selected programme will be inserted.

Press **Blue** button to activate "Cancel" function of "Insert" process.

Delete:

To start the "Delete" process, press the yellow "Delete" button, ("Name", "Insert" and "Autostore" functions are inactive). Pressing yellow button again erases the selected programme from the programme list, and the programmes below shift one up. Pressing

Blue button cancels the activated “Delete” process.

Autostore:

To enter Autostore menu, press the blue button. To learn the features of this function see “Autostore” below.

Autostore, searches and stores all channels automatically on your TV, according to the transmission of programme systems in your area.

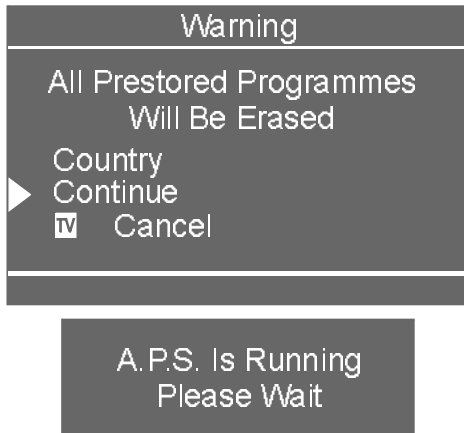

First of all choose the “Country” by using “◀” or “▶” button.

To cancel **Autostore** before starting, press “TV” button. To select “Continue” use “△” or “▽” button and press “◀” or “▶” button.

After Autostore is finalized, a programme list will appear on the screen. In the programme list you will see the programme numbers and names assigned to the programmes.

If you do not accept the locations and/or the programme names of programmes, you can change them in Programme menu.

Source Menu

You can switch your TV to AV modes by pressing directly “AV” button or by selecting in source menu from the main menu.

While in AV mode, you can also switch your TV to TV or other AV modes by selecting in source menu from the main menu.

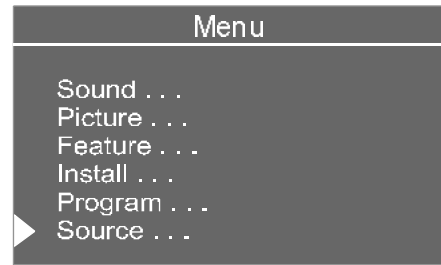

In main menu, firstly use “△” or “▽” button then use “◀” / “▶” or “OK” button to enter Source menu. In source menu, move the cursor by “△” or “▽” button and then press “OK” button or “◀” or “▶” buttons when the cursor is on the required item. The selected mode comes automatically on the screen.

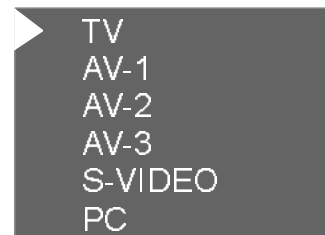

Other Features

TV Status

Programme Number, **Programme Name** (or AV), (they are displayed on the upper left of the screen) and **Sleep Timer** (shows the time left on the upper right screen if enabled). The **sound indicator** and **picture mode** are displayed with them too. They are displayed after programme change for 3 seconds.

P 01 Programme Number

PR 01 Programme Name (4 characters)

These OSD's are displayed when a new programme is entered by digit button or by pressing “P<P”, “-P/CH”, “P/CH+”, “TV”, “AV” or “EI” button.

Programme Swap (P<P)

This button is used to go to the previously entered programme again. Pressing “P<P” consecutively allows to swap into two last entered programmes.



Double-digit (- / - -)

This OSD is displayed when the "Double-Digit" button pressed in place of the programme number indicator.

P - -

In order to enter a two digit programme number you must push both numbers within 3 seconds. If the second number is not entered within 3 secs the display will disappear.

Personal Preferences (PP)

All the preset values will be restored, when pressing "PP".

PP

Sound Indicator

The alternatives of the indicator are Mono, Stereo, Dual I and Dual II. This indicator is displayed under the programme number indicator on the screen. "I-II" button is used to select Mono or Stereo, or Dual I or Dual II.

MONO

In Mono broadcast or in forced-mono (for stereo broadcast).

STEREO

In Stereo broadcast.

DUAL I

If dual broadcast detected. Dual I is selected in default and also can be selected after Dual II by Remote Control.

DUAL II

If Dual II selected by Remote Control.

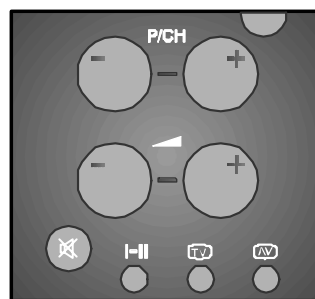

Picture Mode

Picture mode OSD is displayed when "Mute" button is pressed. Picture mode can be changed to **Auto**, **4:3**, **16:9**, **Cinema**, **Subtitle**, **Zoom** or **Panorama** by pressing "Mute" button.

Sleep Timer Indicator

It is displayed on the upper right of the screen when a new programme is entered by digit button or by pressing "P<P", "-P/CH", "P/CH+", "TV", "AV" or "EI" button. If sleep timer is activated it is displayed with the TV status and erased with it after 3 seconds.

Once the time set with the sleep timer has elapsed, the set will go to standby.

0:15

Mute Indicator

It is placed in the upper middle of the screen when enabled, and it stays there until it is disabled.



To cancel mute, there are two alternatives; the first one is pressing "Mute" button, the volume is set to the preceding value. The second one is increasing the volume level, whereby it starts at the minimum level to increase. By decreasing the volume level in mute state, mute will not be ignored, only the volume level will decrease. If mute is cancelled after decreasing the volume level, the volume will be set the decreased level.

No-Signal Detection (TV)

If no valid signal detected, it takes 5 minutes for the set to switch to Standby mode unless a signal is detected or a command is received from the remote control.

After a Remote Control command (if No-Signal Timer is active) the timer stops and if no signal detected again the timer is initialized to 5 minutes and starts 3 seconds later again to count down.

It is not valid in AV mode.

4:31

No-Signal Detection (PC)

If no valid signal detected for 5 minutes system goes to Stand-By mode. To switch on the system press "⏻" button.

No input signal detected

As the last status feature, system starts from TV or PC, whichever was the status before stand-by or switch-off. Note that SCART inputs have the precedence on both TV and PC.

Volume Bar

It is displayed in the lower middle of the screen. When a volume command is received (pressing "▲ +" or "▲ -" by Remote Control or Control panel at the top of the TV) and no menu is active, it stays on the screen for 3 seconds, after the last volume command or until another command is received in between.



AV Modes

By pressing the "AV" button you can switch your TV to AV modes (except being in Teletext). Pressing this button will consecutively switch the TV in one of the optional AV modes: AV-1, AV-2, AV-3, S-VIDEO, PC.

In order to quit the AV mode press the "TV", digit buttons or "-P/CH" or "P/CH+".

Signal Out Of Range

When the PC input signal is not supported by LCD-TFT TV, a message is displayed like "Signal out of range" and screen is blanked.

Signal out of range

PC MODE

Installation

- Power off both Computer and Display before making any connections.
- Connect one end of the optional 15 pin signal cable to the 15 pin connector on the PC and the other end to the 15 pin socket on the TV.

15 Pin Mini D-Sub Connector

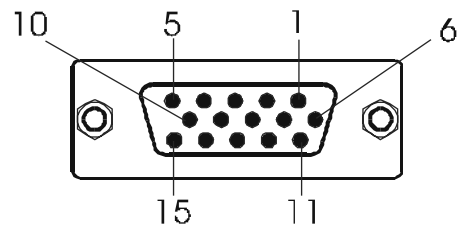

- Tighten the screws of the Display cable until the connectors are fastened securely (finger-tighten only).
- If you are using Windows operating system running on a PC with a Microsoft Plug & Play compatible video card, your system will select the appropriate timing for your monitor.

Switching from TV to PC

Press "PC" button to switch directly PC mode.

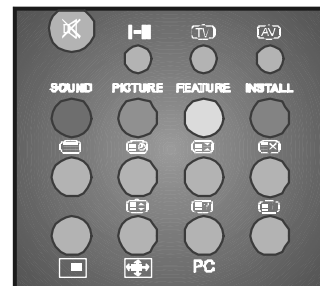

Main Menu in PC mode:

Enter the main menu by pressing the "M" button on the remote control.

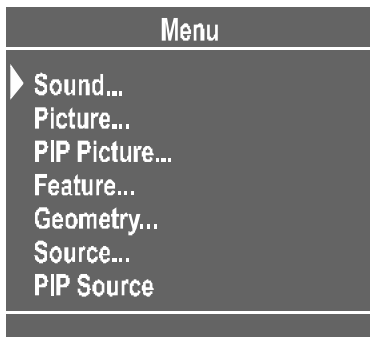

Sound Menu

In the main menu select “Sound” using “ Δ ” or “ ∇ ” button then enter the Sound menu pressing “ \triangleleft ”, “ \triangleright ” or “OK” buttons.

The items in this menu are described at Sound menu starting page 45.

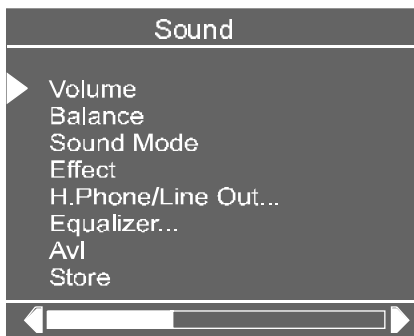

Picture Menu

In the Main menu, select “Picture” using “ Δ ” or “ ∇ ” button, then enter the Picture menu pressing “ \triangleleft ”, “ \triangleright ” or “OK” buttons.

All adjustment in this menu except Picture Mode is identical to adjustment defined TV picture menu starting on page 47. Picture Mode can be set to **Auto**, **4:3** and **16:9** in PC mode.

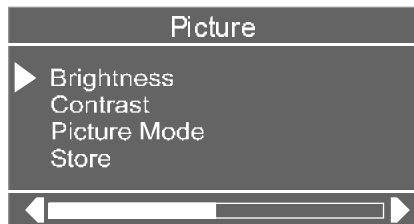



PIP Picture

In the Main menu, select “PIP Picture” using “ Δ ” or “ ∇ ” button, then enter the PIP Picture menu pressing “ \triangleleft ”, “ \triangleright ” or “OK” buttons.

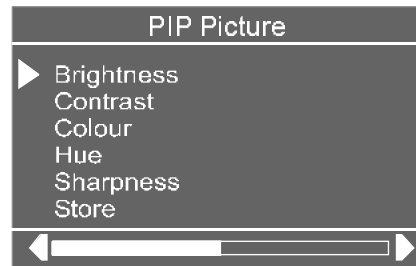
This menu is displayed when PIP is displayed on the screen and otherwise “PIP No Signal” message will be displayed at the bottom of menu.



PIP picture is displayed on the screen with “” button. By pressing “OK” button, PIP window is selected and border of the PIP window becomes green. PIP position is changed by “ \triangleleft ” / “ \triangleright ” button. There are six different PIP positions. PIP size is decreased by “ ∇ ” button and increased by “ Δ ” button. Three different PIP size are available.

Programme in the PIP window is increased / decreased by “P/CH+” / “-P/CH” or digit buttons. AV mode is also available in PIP window. PIP window is removed from the screen by “” button.

Feature Menu:

In the main menu select “Feature” using “ Δ ” or “ ∇ ” button then enter the Feature menu pressing “ \triangleleft ”, “ \triangleright ” or “OK” buttons.

The items in this menu are described at Feature menu starting page 49.

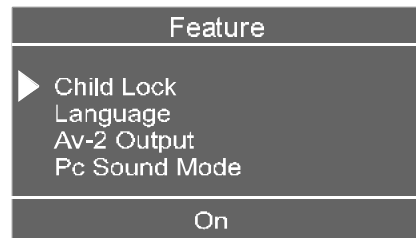

PC SOUND MODE:

This item selects the sound source for PC mode. But when the PIP is displayed and highlighted in green border, sound switches to whatever is displayed in the PIP. Whenever you close the PIP or make the PIP border blue again by disselecting the PIP, sound switches back to PC Sound Mode.

Geometry Menu:

In the Main menu, select “**Geometry**” using “ \triangle ” or “ ∇ ” button, then enter the Geometry menu pressing “ \triangleleft ”, “ \triangleright ” or “**OK**” buttons.

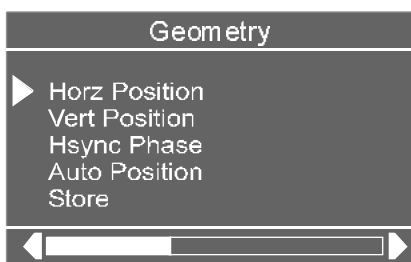

Adjust the required horizontal or vertical position or Hsync Phase by “ \triangleleft ”, “ \triangleright ” buttons.

You can make position adjustment directly by Auto position.

Select Auto position by “ \triangle ” or “ ∇ ” buttons and press “ \triangleleft ” or “ \triangleright ” button.

“Wait” is displayed at the bottom of the menu. After a few seconds screen geometry is adjusted automatically.

Warning: Auto position adjustment recommended to be done with the full screen image for the proper adjustment.

To store this menu setting select “Store” by “ \triangle ” or “ ∇ ” buttons and then press “**OK**” button, “Stored” will be displayed for few seconds at the bottom of menu.

Source Menu:

In the Main menu, select “**Source**” using “ \triangle ” or “ ∇ ” button, then enter the Source menu pressing “ \triangleleft ”, “ \triangleright ” or “**OK**” buttons.

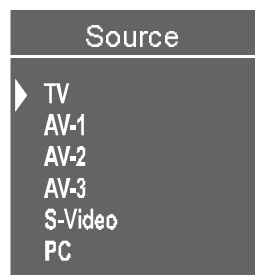

Select the available sources of TV, AV-1, AV-2, AV-3, S-Video or PC by pressing “ \triangleleft ”, “ \triangleright ” or “**OK**” buttons.

PIP Source Menu:

This menu is available when the PIP displayed.

In the Main menu, select “**PIP Source**” using “ \triangle ” or “ ∇ ” button, then select the any available source of TV, AV-1, AV-2, AV-3 or S-Video pressing “ \triangleleft ”, “ \triangleright ” then “**OK**” buttons.

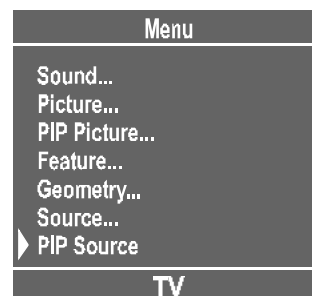

Teletext

Teletext is an information system that displays text on your TV screen. Using the Teletext information system you can view a page of information on a subject that is available in the list of contents (index).

On screen display is not available in text mode.

Contrast, brightness or colour control is not available, but volume control is available in text mode.

To operate Teletext

- Select a TV station on which Teletext is being transmitted.
- Press (TELETEXT) “” button. Usually the list of contents (index) is displayed on the screen.

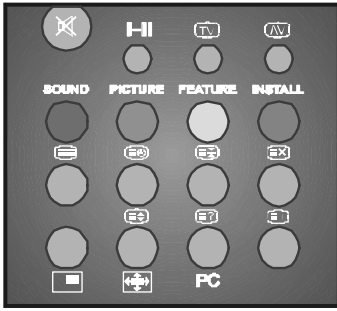

To select a page of Teletext

- Press the appropriate digit buttons for the required Teletext page number.

The selected page number is displayed at the top left corner of the screen. The Teletext page counter searches until the selected page number is located, so that the desired page is displayed on the screen.

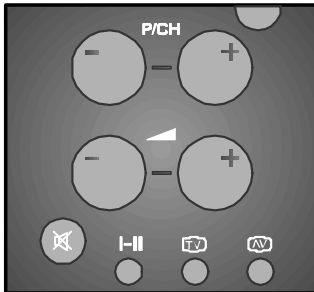

- Press “P/CH +” button to move the Teletext screen forward one page at a time.
- Press “- P/CH” button to move the Teletext screen backward one page at a time.

To Select Index Page

- To select the page number of the index (generally page 100), press “**Ⓢ**” button.

To Select Double Height Text

- Press “**Ⓢ**” button for the top half of the information page to be displayed in double height text.
- Press “**Ⓢ**” button again for the bottom half of the information page to be displayed in double height text.
- Press “**Ⓢ**” button once more for the full page of normal height text.

To Reveal “concealed” Information

- Pressing “**Ⓢ**” button once will reveal answers on a quiz or games page.
- Pressing “**Ⓢ**” button again will conceal the revealed answers.

To Stop Automatic Page Change

The teletext page you have selected may contain more information than what is on the screen; the rest of the information will be displayed after a period of time.

- Press “**Ⓢ**” button to stop the automatic page change.
- Press “**Ⓢ**” button again to allow the next page to be displayed.

To Select a Subpage

Subpages are subsections of long Teletext pages that can only be displayed on the screen one section at a time.

- Select the required Teletext page.
- Press “**Ⓢ**” button.
- Select the required subpage number by pressing four digit buttons (e.g. 0001).
- If the selected subpage is not displayed in a short time, press “**Ⓢ**” button. TV programme will be displayed on the screen.
- Teletext page number will be displayed on the upper left corner of the screen when the selected page is found.
- Press “**Ⓢ**” button to display the selected Teletext page.



Fastext

Your CTV supports the 7 page Teletext system. When the page number of any of the 7 pages in memory is entered, the system will not search for the requested page; instead it will display the page automatically.

- Press “**P/CH +**” button to move the Teletext screen forward one page at a time.
- Press “**- P/CH**” button to move the Teletext screen backward one page at a time.

For Fastext

The subject-heading for the information may have a particular colour.

- Press an appropriate **Red, Green, Yellow** or **Blue** button in order to reach the relevant page quickly.

To exit Teletext

- Press “**TV**” or “**≡**” button. The screen will switch to TV mode.

To Display the Time

- While watching a TV programme with Teletext transmission press “**⌚**” button. The current time information, captured from Teletext will be displayed at the upper right of the screen until the “**⌚**”, “**AV**” or “**M**” button pressed.
- If the programme being watched does not have Teletext transmission, no information will be displayed.

Peripheral Equipment Connections

There is a wide range of audio and video equipment that can be connected to your TV.

Connection diagrams at the end of this section show you where the different equipment should be connected at the back side of the TV.

PC Sound Connection

- Connect the PC Audio output to the TFT **PC Audio In** socket with stereo connection cable.
- In the main menu select "Feature" using “**△**” or “**▽**” button then enter the Feature menu pressing “**◀**”, “**▶**” or “**OK**” button. Come on "PC Sound Mode" using “**△**” or “**▽**” button and select **PC** from the TV, AV-1, AV-2, AV-3 and PC options using “**◀**”, “**▶**” or “**OK**” button.
- **Source** also should be selected as **PC** in the main menu.

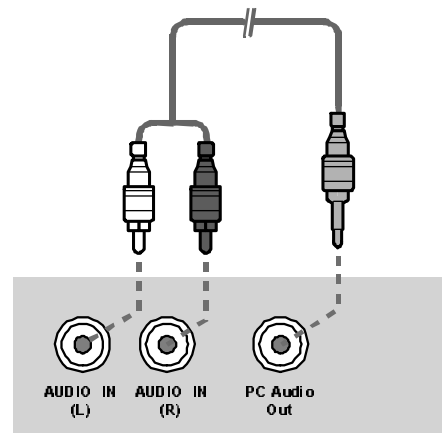

Via the Euroconnector

Your TV set has 2 Euroconnector sockets. If you want to connect peripherals (e.g. video, decoder, etc.) which have Euroconnectors, to your TV, use **SCART** input.

If an external device is connected via Euroconnector sockets TV is switched to AV mode automatically. In this case if both sockets are connected SCART-1 has the precedence.

In AV mode if you press the “**i**” button the TV status OSD is displayed on the screen.

Via Aerial Input

If you want to connect to your TV, peripherals like video recorders or decoders, but the device you want to connect does not have Euroconnector, you should connect it to the Aerial input of your TV set.

Peripheral Equipment Connections

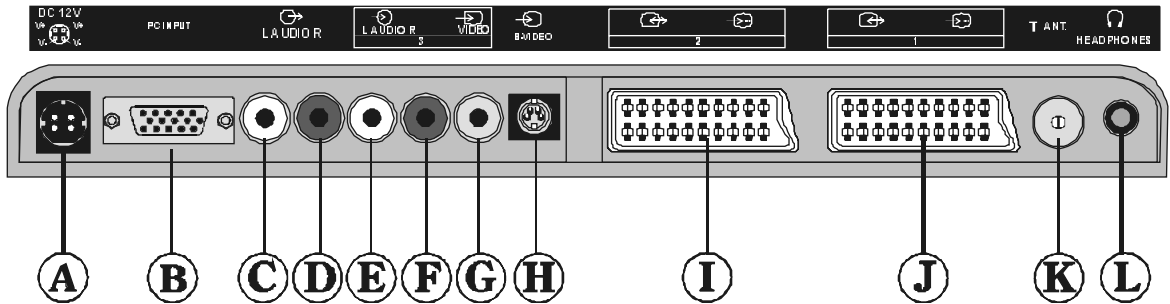
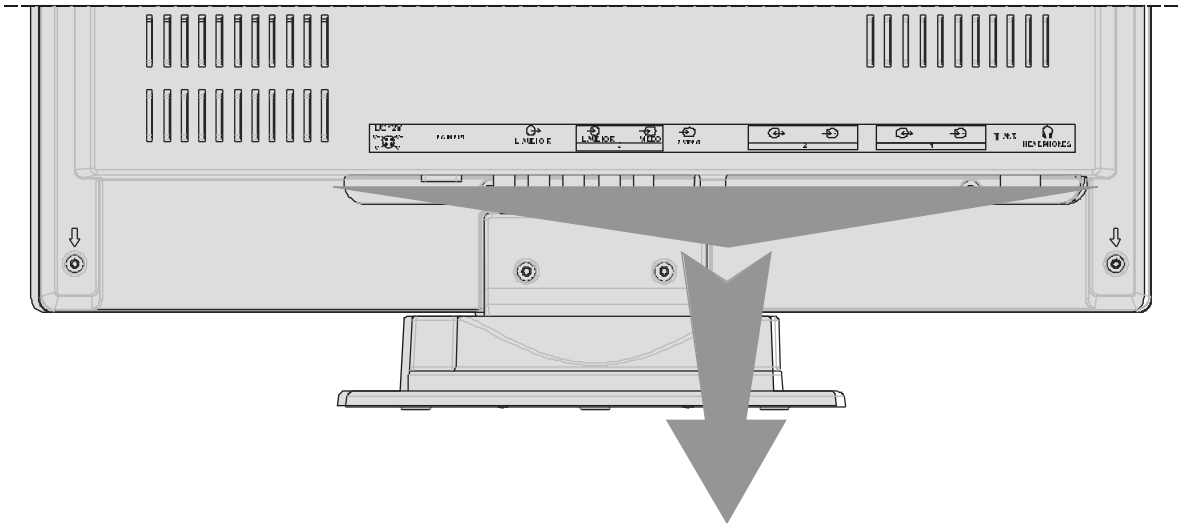

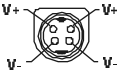
- | | | | | |
|---|-----------------|---|---|-----------------------|
| Ⓐ | DC 12 V |  | ⓓ | LINE OUT (R) |
| Ⓑ | PC INPUT | | ⓔ | AUDIO INPUT (L) |
| Ⓒ | LINE OUT (L) | | ⓕ | AUDIO INPUT (R) |
| Ⓓ | LINE OUT (R) | | ⓖ | VIDEO INPUT |
| Ⓔ | AUDIO INPUT (L) | } (AV-3) | ⓓ | S-VIDEO INPUT |
| ⓕ | AUDIO INPUT (R) | | ⓓ | SCART SOCKET 2 (AV-2) |
| ⓖ | VIDEO INPUT | | ⓔ | SCART SOCKET 1 (AV-1) |
| | | | ⓕ | AERIAL |
| | | | ⓕ | HEADPHONE |

AERIAL Connections

Outdoor Aerial Connections

VHF Aerial

Method 1

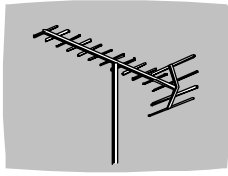

Round 75 ohm coaxial cable



VHF/UHF

Rear of TV

VHF/UHF Aerial

Method 2

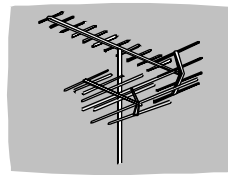

Flat 300-ohm twin lead cable

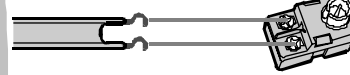

Round 75-ohm coaxial cable



VHF/UHF

Rear of TV

Peripheral Equipment Connections

HEADPHONE



AUDIO

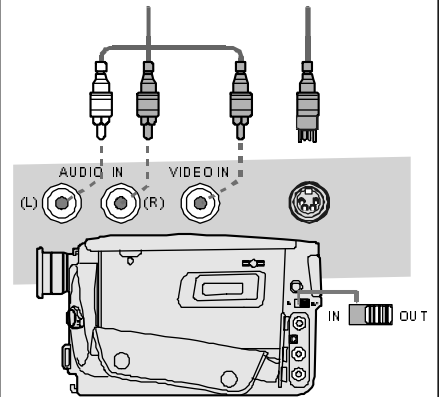
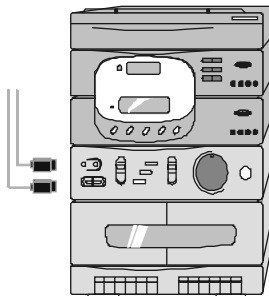

CAMCORDER

VIDEO

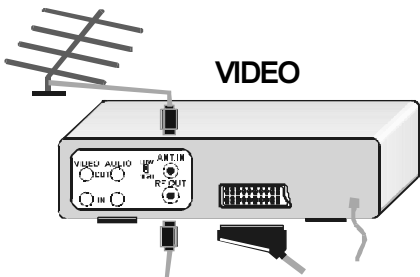

DECODER

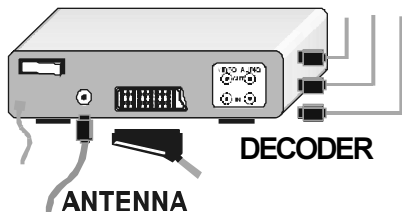

ANTENNA

FOR SATELLITE RECEIVER

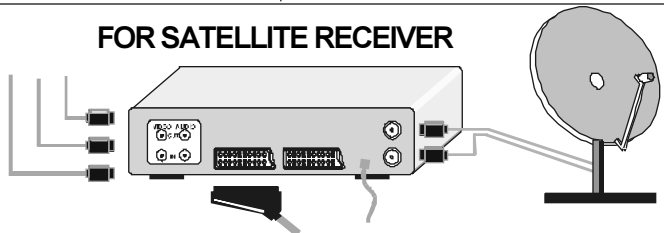

If the VCR is connected via aerial input it is suggested that you use the Programme 0.

Decoder

Cable TV offers you a wide choice of programmes. Most of them are free, others are to be paid for by the viewer. This means that you will need to subscribe to the broadcasting organisation whose programmes you wish to receive. This organisation will supply you a corresponding decoder unit to allow the programmes to be unscrambled.

For further information ask your dealer. See also the booklet supplied with your decoder.

Connect a decoder with an aerial socket to the TV

- Connect the aerial cable.

Connect a decoder without an aerial socket to the TV

- Connect the decoder to your TV with a eurocable (RCA Jack Cable) to **EXTERNAL** (RCA Jack). When your decoder has a Euroconnector / RCA Jack you can obtain better picture quality if you connect a eurocable (RCA Jack Cable) to **EXTERNAL** (RCA Jack).

TV and Video Recorder

- Connect the aerial cables.

Better picture quality can be obtained if you also connect a eurocable to **EXTERNAL socket**.

Playback NTSC

Connect NTSC VCR player to one of two Euroconnectors at the back of the TV.

Then, press "**AV**" button to select AV-1 or AV-2.

Search for and store the test signal of the video recorder

- Unplug the aerial cable from the aerial socket "Aerial" of your video recorder.
- Switch on your TV and put the video recorder on the test signal. (See the handbook for your video recorder.)

- Search for the test signal of your video recorder in the same way as you searched for and stored the TV signals. See Install, Search and Store TV channels. Store the test signal under programme number 0.

– Replace the aerial cable in the aerial socket "Aerial" of your video recorder once you have stored the test signal.

Camera and Camcorder

To connect to (AV-3) input

Connect your camera or camcorder at the rear side of your TV.

- Connect your equipment to the TV via **VIDEO** (yellow), **AUDIO R** (red) and **AUDIO L** (white) inputs. You should connect the jacks to the input of the same colour.

Connect the decoder to the video recorder

Some video recorders have a special euroconnector for decoder.

- Connect a eurocable to the euroconnector of your decoder and to the special euroconnector of your video recorder. See also the handbook of your video recorder.
- To connect your video recorder to the TV, see TV and Video Recorder section.

If you want to connect more equipment to your TV, consult your dealer.

Connecting Headphones

Use the stereo headphone socket on the rear side of your TV, to connect headphones.

Connecting the PC

Connect PC monitor with 15-pin PC cable to the 15-pin connector on the rear of the computer. For detail installation procedure see **Installation** in PC mode.

To connect to S-Video input

Connect your camera or camcorder at the rear side of your TV.

- Connect your equipment to the TV via S-Video input at the back side by using S-Video cables.

PC INPUT TYPICAL DISPLAY MODES

The display has a maximum resolution of 1280 x 768, vertical sync. frequency range of 50-75 Hz and a horizontal sync. frequency range of 30-69 KHz.

The following table is an illustration of some of the typical video display modes.

<i>Mode</i>	<i>Resolution</i>		<i>Frequency</i>		<i>Sync. Polarity</i>	
	<i>Horizontal</i>	<i>Vertical</i>	<i>Hor. (kHz)</i>	<i>Ver. (Hz)</i>	<i>Hor.</i>	<i>Ver.</i>
1	640	400	31.5	70	-	+
2	640	480	31.5	60	-	-
3	640	480	37.9	72	-	-
4	640	480	37.5	75	-	-
5	720	400	31.5	70	-	+
6	800	600	35.2	56	+	+
7	800	600	37.9	60	+	+
8	800	600	48.1	72	+	+
9	800	600	46.9	75	+	+
10	1024	768	48.4	60	-	-
11	1024	768	56.5	70	+	+
12	1024	768	60.0	75	+	+
13	1280	720	44.8	60	-	+
14	1280	768	47.8	60	-	+

The native resolution of the TFT-LCD Panel is 1280 x 768. Therefore using Mode 14 is advised to get the best PC input display quality.

Tips

Care of the Screen

Clean the screen with a slightly damp, soft cloth. Do not use abrasive solvents as they may damage the TV screen coating layer

Colours of image on screen are abnormal

For TV :

Have you selected the correct TV system? Is your TV set or house aerial located too close to the loudspeakers, non-earthed audio equipment or neon lights, etc. ?

Mountains or high buildings can cause double pictures or ghost images. Sometimes you can improve the picture quality by changing the direction of the aerial.

Is the picture or Teletext unrecognisable? Check if you have entered the correct frequency.

The picture quality may degrade when two peripherals are connected to the TV at the same time. In such a case, disconnect one of the peripherals.

For Monitor :

- Check that Video (Signal) Cable from the Display has been securely and correctly connected to the 15-pin Video Connector on the rear panel of the Computer.
- If you have used an adaptor to convert the 15-pin Video (Signal) Cable Connector from the Display to fit the connector on the rear of the Computer, check the pin assignment of the Display.

No Image on Display Screen

For TV :

Is the aerial connected properly? Are the plugs connected tightly to the aerial socket? Is the aerial cable damaged? Are suitable plugs used to connect the aerial? If you are in doubt, consult your dealer.

No Image means that your TV is not receiving any transmission. Have you pressed the

correct buttons on the remote control? Try once more.

For Monitor :

- Check that power cord of the Display has been connected securely into wall outlet or grounded extension cable or strip.
- Display is equipped with electronic power switch, it will remain power-off in case of any power failure. It is necessary to push power switch again to power-on the display. Check that LED on front of display is green.
- Check that Video (Signal) Cable from the Display has been securely and correctly connected to the 15-pin Video Connector on the rear panel of the Computer.
- Check that Video Card is firmly seated in card slot of Computer motherboard.
- Check that the Brightness and/or the Contrast adjustments of the Display have not been turned down to minimum levels.

Sound

You can not hear any sound. Did you perhaps interrupt the sound, pressing “~~X~~” button? Are external speakers connected to the TV?

Sound is coming from only one of the speakers. Is the balance set to one direction extreme? See **Sound** menu.

Remote Control

Your TV no longer responds to the remote control. Press the “TV” button on the remote control once more. Perhaps the batteries are exhausted. If so you can still use the buttons on the control panel at the top of your TV.

Have you selected the wrong menu? Press “TV” button to return to TV mode or press “M” button to return to the previous menu.

No solution:

Switch your TV set off and on. If this does not work, switch off, remove the mains plug and call the service personnel; never attempt to repair it yourself.

Specifications

TV BROADCASTING

PAL SECAM B/G , L/L'

RECEIVING CHANNELS

VHF (BAND I/III)

UHF (BAND U)

HYPERBAND

CABLE TV (S1-S20/ S21-S41)

Input Signal

Video: Analog 0.7 Vp-p 75 ohm positive

Sync: TTL Level positive or negative,
Separate sync.

Horizontal Timing 30 - 69 KHz

Vertical Timing 50 - 75 Hz

Dot Rate

78.75 MHz max.

Video Cable/Input Connector

15 pin mini D cable

PANEL

Size : 17" (43 cm) diagonal

Visible Picture Size

370.5 mm horizontal x 222.3 mm Vertical

Displayable Resolution

1280 x 768 maximum

Non-interlaced

NUMBER OF PRESET CHANNELS 100

CHANNEL INDICATOR

On Screen Display

RF AERIAL INPUT

75 Ohm (unbalanced)

OPERATING VOLTAGE

For adaptor: 220-240 V AC, 50 Hz.

For TV : 12 V DC

AUDIO

German + Nicam Stereo

AUDIO OUTPUT POWER

2 x 3 W_{RMS}. (%10 THD)

POWER CONSUMPTION (W) (max.)

42

STAND-BY (⏻) POWER

<3W

DIMENSIONS (WxHxD)

W 445 mm.

H 365 mm.

D 175 mm. with stand

65 mm. without stand

Weight 4.8 Kg.

HITACHI

Hitachi, Ltd. Tokyo, Japan
International Sales Division
THE HITACHI ATAGO BUILDING,
No. 15-12 Nishi Shinbashi, 2 - Chome,
Minato - Ku, Tokyo 105-8430, Japan.
Tel: 03 35022111

HITACHI EUROPE LTD,

Whitebrook Park
Lower Cookham Road
Maidenhead
Berkshire
SL6 8YA

UNITED KINGDOM

Tel: 01628 643000
Fax: 01628 643400
Email: consumer-service@hitachi-eu.com

HITACHI EUROPE S.A.

364 Kifissias Ave. & 1, Delfon Str.
152 33 Chalandri
Athens

GREECE

Tel: 1-6837200
Fax: 1-6835964
Email: service.hellas@hitachi-eu.com

HITACHI EUROPE GmbH

Munich Office
Dornacher Strasse 3
D-85622 Feldkirchen bei München

GERMANY

Tel: +49-89-991 80-0
Fax: +49-89-991 80-224
Hotline: +49-180-551 25 51 (12ct/min)
Email: HSE-DUS.service@hitachi-eu.com

HITACHI EUROPE S.A.

Gran Via Carlos III, 86, planta 5
Edificios Trade - Torre Este
08028 Barcelona

SPAIN

Tel: +34 93 409 2550
Fax: +34 93 491 3513
Email: atencion.cliente@hitachi-eu.com

HITACHI EUROPE srl

Via Tommaso Gulli N.39, 20147
Milano, Italia

ITALY

Tel: +39 02 487861
Tel: +39 02 38073415 Servizio Clienti
Fax: +39 02 48786381/2
Email: customerservice.italy@hitachi-eu.com

HITACHI Europe AB

Box 77 S-164 94 Kista

SWEDEN

Tel: +46 (0) 8 562 711 00
Fax: +46 (0) 8 562 711 13
Email: csgswe@hitachi-eu.com

HITACHI EUROPE S.A.S

Lyon Office
B.P. 45, 69671 BRON CEDEX

FRANCE

Tel: +33 04 72 14 29 70
Fax: +33 04 72 14 29 99
Email: france.consommateur@hitachi-eu.com

HITACHI EUROPE LTD (Norway) AB

STRANDVEIEN 18
1366 Lysaker

NORWAY

Tel: 67 5190 30
Fax: 67 5190 32
Email: csgnor@hitachi-eu.com

HITACH EUROPE AB

Egebækgård
Egebækvej 98
DK-2850 Nærum

DENMARK

Tel: +45 43 43 6050
Fax: +45 43 60 51
Email: csgnor@hitachi-eu.com

HITACHI EUROPE AB

Neopoli / Niemenkatu 73
FIN-15140 Lahti

FINLAND

Tel : +358 3 8858 271
Fax: +358 3 8858 272
Email: csgnor@hitachi-eu.com

Hitachi Europe Ltd

Bergensesteenweg 421
1600 Sint-Pieters-Leeuw

BELGIUM

Tel: +32 2 363 99 01
Fax: +32 2 363 99 00
Email: sofie.van.bom@hitachi-eu.com

HITACHI EUROPE LTD

Na Sychrove 975/8
101 27 Praha 10 - Bohdalec

CZECH REPUBLIC

Tel: +420 267 212 383
Fax: +420 267 212 385
Email: csgnor@hitachi-eu.com

www.hitachidigitalmedia.com