

HANNSPREE



**26"/32"/37"**  
**Liquid Crystal Display**  
**Television**

MAK-00055

T262/T322/T372

**User's Manual**

HANNSPREE, INC.  
[www.hannspree.com](http://www.hannspree.com)

# Table of Contents

---

Regulatory Information .....	3
Description of Warning Symbols .....	5
Safety Notices.....	6
Preface .....	11
1. Getting Started .....	14
1.1 Package Contents.....	14
1.2 Introducing the TV .....	15
1.2.1 Features .....	15
1.2.2 Control Panel .....	16
1.2.3 Input and Output Jacks .....	17
1.2.4 Remote Control .....	21
1.2.5 Teletext Mode .....	26
1.2.6 Inserting the Remote Control Batteries .....	27
2. Setting up your TV .....	29
2.1 Basic Connections .....	29
2.1.1 Connecting the Power Cord and Turning On.....	29
2.1.2 Connecting an Antenna or Cable TV.....	30
2.2 Connecting External Devices.....	31
2.2.1 Connecting External Earphones .....	31
2.2.2 Connecting an Amplifier Using Analog Audio .....	32
2.2.3 Connecting an Amplifier Using Digital Audio .....	33
2.2.4 Connecting a Decoder/VCR/Recorder or DVD Player Using SCART (EU models only).....	34
2.2.5 Connecting a VCR/STB/DVD Player Using Component Video .....	38
2.2.6 Connecting a VCR/STB/DVD Player Using Composite Video.....	39
2.2.7 Connecting a Video Game Console .....	40
2.2.8 Connecting a PC .....	41
2.2.9 Connecting HDMI .....	42

# Table of Contents

---

2.3 Inserting a Memory Card (For built-in E-Card only) .....	43
2.4 Using the TV .....	45
2.4.1 Using the Remote Control .....	45
2.4.2 Turning the TV On and Off .....	45
2.4.3 Selecting Channels .....	45
2.4.4 Switching Source Signals .....	46
2.4.5 Adjusting the Volume .....	47
2.5 Using the E-Card Function (For built-in E-Card only) .....	48
2.5.1 Remote Control Keys in E-Card Mode .....	50
2.5.2 Viewing Photos .....	52
2.5.3 Listening to Music .....	57
2.5.4 Watching Videos .....	59
2.5.5 Viewing Memory Card Files .....	60
3. Adjusting On-Screen Display (OSD) Settings .....	61
3.1 OSD Setting Menus .....	61
3.2 Adjusting Video Settings .....	63
3.3 Adjusting Audio Settings .....	66
3.4 Adjusting PC Settings .....	68
3.5 Adjusting TV Settings .....	70
3.6 Adjusting Customize Settings .....	73
4. Using POP .....	75
5. Troubleshooting .....	77
6. Warranty and Service .....	79
7. Specifications .....	80
7.1 PC Mode Support Timing .....	81
8. Glossary .....	82



## Regulatory Information

---

### FCC Compliance Statement<sup>1</sup>

This device complies with part 15 of the FCC Rules. Operation is subject to the following two conditions: (1) This device may not cause harmful interference, and (2) this device must accept any interference received, including interference that may cause undesired operation.

### Additional Information

This equipment has been tested and found to comply with the limits for a Class B digital device, pursuant to part 15 of the FCC Rules. These limits are designed to provide reasonable protection against harmful interference in a residential installation. This equipment generates, uses and can radiate radio frequency energy and, if not installed and used in accordance with the instructions, may cause harmful interference to radio communications. However, there is no guarantee that interference will not occur in a particular installation. If this equipment does cause harmful interference to radio or television reception, which can be determined by turning the equipment off and on, the user is encouraged to try to correct the interference by one or more of the following measures:

- Reorient or relocate the receiving antenna
- Increase the separation between the equipment and receiver
- Connect the equipment into an outlet on a circuit different from that to which the receiver is connected
- Consult the dealer or an experienced radio/TV technician for help

**WARNING:** The Federal Communications Commission warns that changes or modifications of the TV not expressly approved by the party responsible for compliance could void your authority to operate the equipment.

---

1. applies only to products purchased in the United States of America

---

### **DOC Compliance Notice<sup>1</sup>**

This digital apparatus does not exceed the Class B limits for radio noise emissions from digital apparatus as set out in the Radio Interference Regulations of the Canadian Department of Communications. This device complies with Canada ICES-003 Class B.

### **CE Conformity Statement<sup>2</sup>**

This device complies with the requirements set out in the Council Directive on the approximation of the laws of the Member States relating to Electromagnetic Compatibility (89/336/EEC) and the Amendment Directive (92/31/EEC), Low-Voltage Directive (73/23/EEC) and the Amendment Directive (93/68/EEC).

- 
1. applies only to products purchased in Canada
  2. applies only to products purchased in the European Union

## Description of Warning Symbols



### Before You Proceed

1. Read all Safety Notices and instructions in this User's Manual carefully before either plugging in or turning the TV on.
2. Keep this User's Manual in a safe place for future reference. Keep the box and packaging in case the TV needs to be shipped in the future.
3. Follow the TV and warning label instructions.
4. Any uses, operations, changes, alterations or modifications of the TV that do not follow the instructions in this manual will void this TV's warranty.



### CAUTION

RISK OF ELECTRIC SHOCK  
DO NOT OPEN



### WARNING



This symbol is used to alert users to pay attention to important descriptions regarding usage, maintenance (repair), and additional important information related to this TV.

### CAUTION



This symbol is used to alert users to the risk of electric shocks due to dangerous and uninsulated components.

## Safety Notices



### Installation Safety Notes

#### Antenna

We suggest that you use an outdoor antenna to get the best signal possible unless you have cable TV or a centralized indoor antenna system. You may, however, use an antenna indoors if it is placed in a location free from interference.

#### Location

Avoid allowing the TV to get prolonged exposure to sunlight or other strong sources of heat. Leave sufficient distance between the TV and the wall to provide enough space for the emission of heat.



### WARNING

To reduce the risk of fire or electric shock, do not expose this apparatus to rain or moisture.

Apparatus shall not be exposed to dripping or splashing and no objects filled with liquids, such as vases, shall be placed on the apparatus.

---

# IMPORTANT SAFETY INSTRUCTIONS

---



- 1 Read these instructions.
  - 2 Keep these instructions.
  - 3 Heed all warnings.
  - 4 Follow all instructions.
- 



- 5 Do not use this apparatus near water.
- 



- 6 Clean only with dry cloth.
- 



- 7 Do not block any ventilation openings. Install in accordance with manufacturer's instructions.
- 



- 8 Do not install near any heat sources such as radiators, heat registers, stoves, or other apparatus (including amplifiers) that produce heat.
-



- 
- 9 Do not defeat the safety purpose of the polarized or grounding-type plug. A polarized plug has two blades with one wider than the other. A grounding-type plug has two blades and a third grounding prong. The wide blade or the third prong are provided for your safety. If the provided plug does not fit into your outlet, consult an electrician for replacement of the obsolete outlet.

**NOTE: Applies to US only.**

- 
- 10 Protect the power cord from being walked on or pinched, particularly at plugs, convenience receptacles, and the point where they exit from the apparatus.



- 
- 11 Only use attachments/accessories specified by the manufacturer.



- 
- 12 Use only with the cart, stand, tripod, bracket, or table specified by the manufacturer, or sold with the apparatus. When a cart is used, use caution when moving the cart/apparatus combination to avoid injury from tip-over.

- 
- 13 Unplug this apparatus during lightning storms or when unused for long periods of time.
-



- 14 Refer all servicing to qualified service personnel. Servicing is required when the apparatus has been damaged in any way, such as power-supply cord or plug is damaged, liquid has been spilled or objects have fallen into the apparatus, the apparatus has been exposed to rain or moisture, does not operate normally, or has been dropped.

---

## CAUTION



These servicing instructions are for use by qualified service personnel only. To reduce the risk of electric shock, do not perform any servicing other than that contained in the operating instructions unless you are qualified to do so.

---

### Notes:

- The LCD TV is for entertainment use only and visual display tasks are excluded.
- This device uses a VGA connector to connect to a PC. To reduce the influence of mains frequency on the source signal, use a VGA monitor cable with ferrite shield.

---

## Personal Safety

---

1. To avoid overloading the power supply, never plug too many electrical devices into an outlet, power strip, or extension cable.
  2. Dangerous high-voltage electric power components are located inside the TV. To avoid electric shock, do not disassemble the casing.
  3. Do not place or drop metals, small objects, or flammable materials into the vent of the TV.
  4. If the TV is dropped, falls down, or is otherwise damaged, unplug the power cord immediately and contact an authorized service technician.
  5. If any fluid is sprayed or dropped into the TV, contact an authorized service technician.
  6. The screen of the TV is made of glass. Avoid hitting or scraping it. If the screen is broken, do not touch the broken glass.
  7. Do not allow children to use the TV unattended.
  8. Be careful when disconnecting the power plug. Hold the plug. Do not attempt to disconnect the plug by pulling on the power cord.
- 

## Installation

---

1. Do not place the TV in locations where there is excessive steam or dust.
  2. Avoid blocking the TV's vents, do not place the TV on a bed, sofa, carpet, or in a sealed cabinet.
  3. Install the outdoor antenna away from power transmission lines to avoid possible danger.
-



## Preface

---

Thank you for purchasing a Hannspree Liquid Crystal Display Television (LCD TV). Your new TV will allow you to enjoy superior audio and video while enriching your lifestyle with advanced technology.

Please carefully read this manual in its entirety before setting up, using or operating your TV. To ensure the safe and correct installation and operations of the TV, it is important that the safety and operation instructions in this manual are followed.

This instruction manual is designed to assist you in setting up and using the TV. The information in this manual has been carefully checked for accuracy; however, no guarantee is given to the correctness of the contents. The information in this manual is subject to change without notice.

To the extent allowed by applicable law, Hannspree, Inc. (“Hannspree”) shall not be liable for direct, indirect, special, exemplary, incidental or consequential damages arising from any defect or omission in this manual, even if advised of the possibility of such damages in advance.

---

## Copyright

© Copyright 2006 Hannspree, Inc.

All rights reserved. This manual is protected by copyright and distributed under licenses restricting its use, copying and distribution. No part of this manual may be reproduced in any form by any means without the prior written authorization of Hannspree. The TV described in this manual may include copyrighted software of Hannspree (or other third parties). Hannspree (or other third parties) preserves the exclusive rights for copyrighted software, such as the right to distribute or reproduce the copyrighted software. Accordingly, and to the extent allowed by applicable law, any copyrighted software contained in the product described herein shall not be distributed, modified, reverse engineered, or reproduced in any manner without the prior written authorization of Hannspree (or of other third parties).

The Hannspree logos presented herein are trademarks of Hannspree. All other product names, trademarks or logos mentioned herein are used for identification purpose only, and may be the trademarks or registered trademarks of their respective owners.

The purchase of the product described herein shall not be deemed to grant, either directly or by implication, estoppel or otherwise, any license under the copyrights, patents, patent applications or trademarks of Hannspree, except for the normal, non-exclusive use that arises by operation of law in the sale of a product.

---

## BBE, SRS, HDMI License Statements



Manufactured under license from BBE Sound, Inc. Licensed by BBE Sound, Inc. under one or more of the following US patents: 5510752, 5736897. BBE and BBE symbol are registered trademarks of BBE Sound, Inc.

BBE ViVA HD3D (High Definition 3D) Sound provides musically accurate natural 3D images with Hi-Fi sound. The clarity of the sound is improved by BBE while the width, depth and height of sound image are expanded by BBE's proprietary 3D sound process. BBE ViVA HD3D Sound is compatible with all TV programs including news, music, dramas, movies, sports and electronic games.



is a trademark of SRS Labs, Inc. TruSurround XT technology is incorporated under license from SRS Labs, Inc.



Hannspree products incorporate High-Definition Multimedia Interface (HDMI™) technology.

HDMI, the HDMI logo and High-Definition Multimedia Interface are trademarks or registered trademarks of HDMI Licensing LLC.



This is a 'HD ready' display device and complies with the 'HD ready' minimum requirements. The 'HD ready' logo is a trademark of EICTA.

## 1.1 Package Contents

Make sure the following components are included in the box. Please contact Hannspree Customer Service immediately if anything is missing or damaged.

- TV
- User's manual
- Quick start guide
- Warranty and service manual
- Power cord
- Remote control and batteries
- A/V cable kit

---

## 1.2 Introducing the TV

You can watch PAL/SECAM broadcast or cable television channels, and easily connect a VCR, STB or DVD player to the standard CVBS, S-Video and SCART input ports (location of these ports depends on model). You can also use the TV as a monitor for your PC by connecting it through the D-sub port.

Convenient control buttons located on the TV and a handy remote control let you change channels, adjust the volume, and change display settings through an easy-to-use on-screen display menu system. The built-in stereo speakers provide full rich sound and a convenient audio output port lets you connect to an external audio system or earphones.

### 1.2.1 Features

- Built-in TV tuner
- Audio/Video support:
  - Stereo audio inputs
  - Composite video inputs
  - Component video inputs
  - S-Video inputs
  - SCART inputs (EU only)
  - 3.5 mm stereo headphone output
  - VGA input
  - HDMI input
  - SPDIF (optical) out
  - R/L/Subwoofer (2.1ch) out (AP only)
- On-Screen Display (OSD) menu system
- Twin picture (POP)
- Teletext (TTX) 2.5v. 1000 pages
- Multi-channel Television Sound (MTS) with SAP
- Built-in stereo speakers
- Image Enhancement Technology
  - 3:2 pull down
  - 3D Comb Filter
- Noise Reduction
- Advanced de-interlacing
- Edge Enhancement
- Memory card reader (support CF, MD, SM, SD, MMC, and MS-Pro cards)

#### Note:

**The supporting devices mentioned in this manual may vary on different models. For more information, please refer to the manufacturer's user manual or the Quick Start Guide of your TV model.**



---



## 1.2.2 Control Panel

Description	Icon	Function
Power/ Power LED	<b>POWER</b>	Turns the TV on and off. Indicates power status.
Source	<b>SOURCE</b>	Selects the input source to be displayed (TV, (DTV), AV1, AV2, AV3, AV4, (AV5), (E-Card), HDMI, PC). <b>Notes:</b> <ul style="list-style-type: none"><li>• <b>DTV is available for specified models.</b></li><li>• <b>AV5 is for Asia Pacific models.</b></li><li>• <b>E-Card is available on selected models only.</b></li></ul>
Menu	<b>MENU</b>	Turns the On-Screen Display (OSD) menu on and off.
Select channel	<b>CH▲/ CH▼</b>	Changes channels. Press <b>CH▲</b> to increase the channel number. Press <b>CH▼</b> to decrease the channel number.
Adjust volume	<b>VOL+/ VOL-</b>	Press <b>VOL+</b> to increase the audio volume. Press <b>VOL-</b> to decrease the audio volume.
Memory card slots		Insert a Compact Flash (CF), Micro drive (MD), Smart Media (SM), Secure Digital (SD), Multi Media Card (MMC), or Memory Stick (MS-Pro) card into this slot to view the contents of the memory card. Use the E-Card mode to view the contents.









---

### 1.2.3 Input and Output Jacks

For European (EU) models

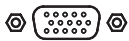

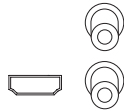
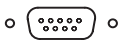

Description	Connector	Function
AV1 (SCART1)		Use the AV1 input to connect an external device, such as a VCR, STB, or a DVD player with composite / RGB output. <b>Audio Input (R/L)</b> <b>Video Input (RGB/V)</b> <b>Audio Output (R/L)</b> <b>Video Output (V)</b>
AV2 (S/V/L/R)		Use the AV2 input to connect an external device, such as a VCR, STB, or a DVD player. <b>Audio Input (L/R):</b> white and red audio cables. <b>Video Input (S-Video or Video):</b> S-Video cable or yellow (video).
AV3 (SCART2)		Use the AV3 input to connect an external device, such as a VCR, STB, or a DVD player. <b>Audio Input (R/L)</b> <b>Video Input (S/V)</b> <b>Audio Output (R/L)</b> <b>Video Output (V)</b> <b>Notes:</b> <ul style="list-style-type: none"><li>• The output function of AV3 is available for selected models.</li><li>• The S-Video or CVBS input of SCART2 is selected in the CUSTOMIZE menu of the OSD.</li></ul>









---

Description	Connector	Function
AV4 (R/L/Y/PB/PR)		Use the AV4 inputs to connect an external device, such as a VCR, STB, or a DVD player with a component output. <b>Audio Input (R/L):</b> red and white audio cables. <b>Video Input (Y/PB/PR):</b> video cables.
ANT (Antenna/ Cable TV line in)		Connects to an antenna or CATV cable television line.
AC IN		Connects to the included power cord.
EARPHONE OUT		Connects to earphones.
PC		Connect to a PC's VGA port.
LINE IN		Connects to a PC's line/audio out port.
LINE OUT (R/L)		Connects to external audio amplifier.
HDMI		Connects to devices such as a DVD player or set-top box.
RS-232		For factory use only. Not available for users.
OPTICAL OUT		Use the optical digital out connector to connect an audio decoder or audio/video processor.

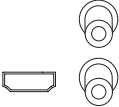

---

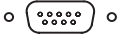
## For Asia Pacific (AP) models





Description	Connector	Function
AV1 (R/L/V)		Use the AV1 input to connect an external device, such as a VCR, STB, or a DVD player with a composite output. <b>Audio Input (L/R):</b> red and white audio cables. <b>Video Input (CVBS):</b> yellow (CVBS) cable.
AV2 (S/V/L/R)		Use the AV2 input to connect an external device, such as a VCR, STB, or a DVD player. <b>Audio Input (L/R):</b> white and red audio cables. <b>Video Input (S-Video or Video):</b> S-Video cable or yellow (video).
AV3 (R/L/S)		Use the AV3 input to connect an external device, such as a VCR, STB, or a DVD player. <b>Audio Input (L/R):</b> red and white audio cables. <b>Video Input (S):</b> S-Video cable.
AV4 / AV5 (R/L/Y/PB/PR)		Use the AV4 / AV5 inputs to connect an external device, such as a VCR, STB, or a DVD player with a component output. <b>Audio Input (R/L):</b> red and white audio cables. <b>Video Input (Y/PB/PR):</b> video cables.

Description	Connector	Function
ANT (Antenna/ Cable TV line in)		Connects to an antenna or CATV cable television line.
AC IN		Connects to the included power cord.
PC		Connect to a PC's VGA port.
HDMI		Connects to devices such as a DVD player or set-top box.
LINE IN		Connects to a PC's line/audio out port.
LINE OUT (R/L)		Connects to external audio amplifier.
SUBWOOFER OUT		Connects to a subwoofer speaker with audio amplifier.
EARPHONE OUT		Connects to earphones.
RS-232		For factory use only. Not available for users.
OPTICAL OUT		Use the optical digital out connector to connect an audio decoder or audio/video processor.







## 1.2.4 Remote Control

Description	Icon	Function
Menu	<b>Menu</b>	Press this button to turn the On-Screen Display (OSD) menu on and off.
Arrow		Press <b>▲ / ▼ / ◀ / ▶</b> to scroll through the on-screen display menus. In memory card mode, press the arrow buttons to navigate menus, or to pan a picture when zooming in on a photo in Photo mode.
Numbers 0 ~9	1 2 3 4 6 5 7 8 9 0	Use to select a channel directly. Press 0-9 to enter the channel number (press 1 and 0 for channel 10). You can key in the alphabet in channel name editing function.
Last	<b>Last Slideshow</b>	Press this button to return to the last channel selected. In memory card mode, press this button to start and end the slideshow.
Power	 <b>Power</b>	Press this button to turn the TV power on or off.
Adjust volume	<b>+ -</b> <b>VOL+ / VOL-</b>	Press <b>VOL +</b> to increase the audio volume. Press <b>VOL -</b> to decrease the audio volume.
Mute	<b>Mute</b>	Press this button to eliminate sound. Press mute again or press the volume adjust buttons to restore sound.

Description	Icon	Function
Select channel (AP models)	<b>CH▲ / CH▼</b>	Changes channels. Press <b>CH▲</b> to increase the channel number. Press <b>CH▼</b> to decrease the channel number. (Press <b>CH▲ / CH▼</b> or numbers buttons to have all sources return to TV mode.)
Select channel (EU models)	<b>P▲ / P▼</b>	Changes channels. Press <b>P▲</b> to increase the channel number. Press <b>P▼</b> to decrease the channel number. (Press <b>P▲ / P▼</b> or numbers buttons to have all sources return to TV mode.)
Source	<b>Source</b>	Press this button to display the AV source list on the screen.
Display	<b>Display</b>	Press this button to show messages on the screen, such as the channel number, mode and others. Press this button again to close the displayed message.
TV	<b>TV</b>	Press this button to select TV source mode. Press this button again to enter DTV mode (available only for selected models).
Favorite	<b>FAV1/FAV2 FAV3/FAV4</b>	Press these buttons to select or store your favorite channels. (e.g. To set Ch. 33 as FAV1, go to Ch. 33 and press <b>HOLD</b> , and then press <b>FAV1</b> to save your settings.) In TTX mode, these buttons are the color-coded hot keys.

Description	Icon	Function
Wide	 Wide	Press this button to switch between wide screen and other modes (4:3 – 16:9). (Panoramic mode is available only for selected models.) In memory card mode, press this button to stop proceeding operation.
Hold	 Hold	Press this button to hold. In memory card mode, press this button to go to the next track or picture.
Sleep	 Sleep Zoom	Press this button repeatedly to set the length of time until the TV turns off. Cancel the timer by pressing until the displayed time disappears. In memory card mode, press this button to zoom in a picture (magnification varies by input format).
Electronic Program Guide		Press this button to view the electronic program guide (EPG) (available only for selected models). In memory card mode, press this button to toggle between the EQ mode for music or the slideshow mode for photo.
DTV Information		Press this button to display information about the current channel (available only for selected models). In memory card mode, press this button to repeat the playing operation.



Description	Icon	Function
Swap	 Swap	Press this button to swap the activation of the primary and secondary sources for Twin mode (available only for selected models). In memory card mode, press this button to fast rewind.
Fast Forward		In memory card mode, press this button to fast forward.
Teletext (EU models only)	 TTX	Press this button to switch to teletext mode. In memory card mode, press this button to rotate a picture when in Photo mode.
MTS	 M/II	Press this button to change the multi sound selection of the TV channel.
OK	 OK	Press this button to execute the selection or setting and return to the last menu when using on screen display menus. In memory card mode, press this button to confirm a selection or play/pause the file playback.
Twin Mode	 Twin	Press this button to activate the picture by picture mode (available only for selected models). In memory card mode, press this button to return to the previous file.

---

Description	Icon	Function
Light	<b>Light</b>	Press this button to activate the remote control backlight. When you press a button, the backlight will turn off. To turn it back on, press this button again.

---

---

## 1.2.5 Teletext Mode

Description	Icon	Function
Numbers (0-9)	1 2 3 4 6 5 7 8 9 0	Use the number keys to enter the teletext page number directly.
Favorite	FAV1/FAV2 FAV3/FAV4	The color keys are used with the icons at the bottom of the Teletext page.
Arrows	◀ ▶	Use the right and left keys to go to the desired page.
Wide	■ Wide	Increases the zoom magnification of each page. Press the button to increase zoom of the top half of the page and press again to increase the zoom of the bottom half of the page. Press the button a third time to restore the page to normal size.
Teletext	⤿ TTX	Press once to open the teletext window. Press again to close the teletext window.

---

## 1.2.6 Inserting the Remote Control Batteries

- 1 Open the battery compartment cover at the back of the remote control.

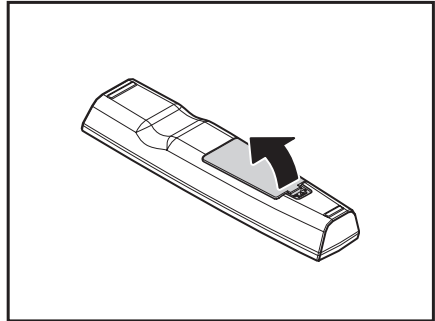

- 2 Insert the batteries paying attention to the polarity markings inside the battery compartment.

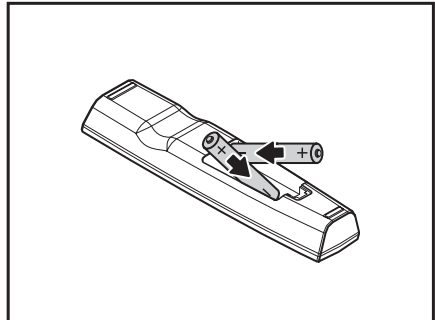

- 3 Replace the battery compartment cover.

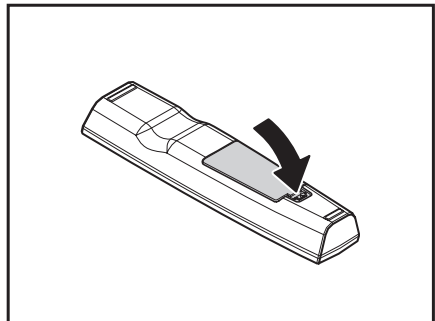

---

# CAUTION



- If the remote control is not used for a long period, remove the batteries and store them properly.
- Handle damaged or leaking batteries carefully, and wash hands with soap if they come in contact with leaked chemical fluids.
- If your remote control has two batteries, do not mix new and old batteries or the life of the new batteries will be shortened. Chemical fluids may leak from the old batteries.
- Danger of explosion if battery is incorrectly replaced. Replace only with the same or equivalent type recommended by the equipment manufacturer. Discard used batteries according to manufacturer's instructions.
- Refer to your local recycling or waste disposal rules and contact a local waste disposal vendor to dispose of used batteries.
- The remote control cover may have a magnet in it, so do not place magnetic sensitive items such as watches, credit cards, or flash media close to the cover.
- Do not use force when pulling the remote control cover open; you may damage the hinge.

### 2.1 Basic Connections

The following sections provide users with some basic instructions to use the TV. Please read them carefully before you start utilizing the functions.

#### 2.1.1 Connecting the Power Cord and Turning On

- 1 Connect the power cord to AC IN input jack on the rear panel of the TV.
- 2 Insert the plug at the other end of the power cord into a power outlet.
- 3 Move the Main Power Switch to the ON position to supply power to the TV.

**Note:**

**If the TV is not going to be used for a long period, turn off the main power switch.**

---

## 2.1.2 Connecting an Antenna or Cable TV

- 1 Connect one end of the VHF/UHF (Antenna) or CATV cable to ANT Jack (RF-in Analog) on the back of the TV.
- 2 Connect the other end of the VHF/UHF (Antenna) or CATV cable to the antenna socket or CATV socket.

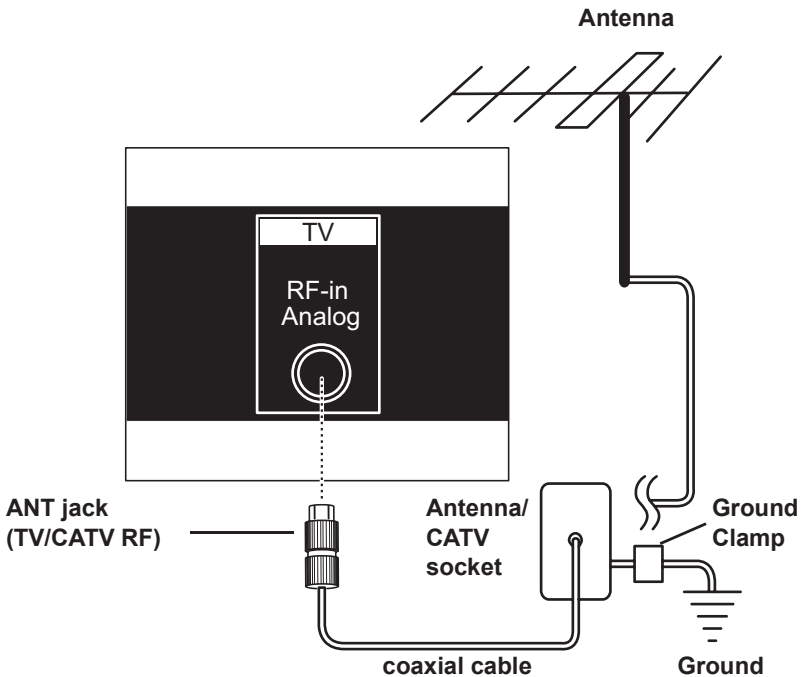

### Note:

If you cannot receive channels after connecting to an antenna or cable TV line, try scanning for channels. See "Auto Search" on page 71.

---

## 2.2 Connecting External Devices

Connect external devices such as VCRs, STBs, or DVD players to the TV using the AV1, AV2, AV3, AV4 and AV5 ports on the back or side of the TV.

**Note:**

**AV5 is for AP market only.**

### 2.2.1 Connecting External Earphones

External earphones may be used to listen to the TV rather than using the built-in speakers. Connect external headphones to the earphone line out port as illustrated.

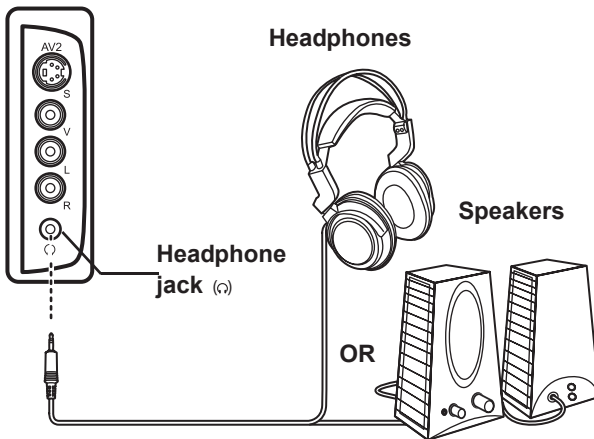

**Notes:**

- External earphones are not included with the TV.
- The built-in TV speakers do not output sound when earphones are plugged in.
- Location of the connectors varies according to the TV model. For more information, please refer to manufacturer's user manual or the the Quick Start Guide of your TV model.



---

## 2.2.2 Connecting an Amplifier Using Analog Audio

Connect an external amplifier or speakers to the line out port to provide better sound quality. Refer to the following illustration.

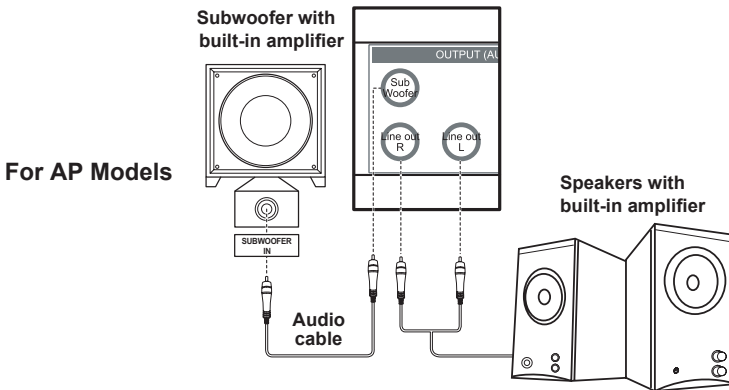
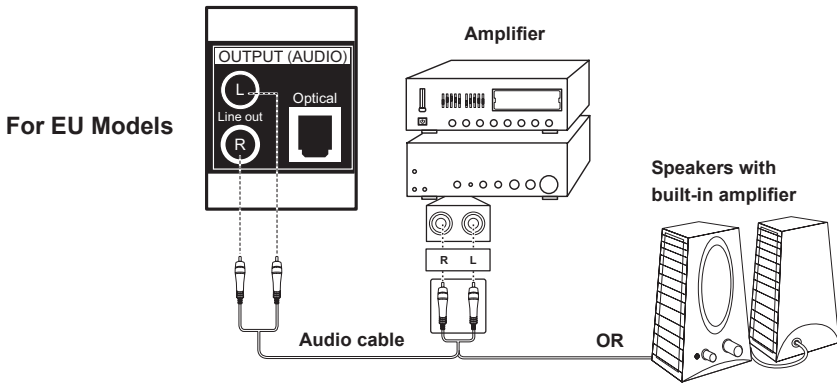

**Note:**

External amplifier or powered speakers *are not included with the TV.*

---

### 2.2.3 Connecting an Amplifier Using Digital Audio

Use the optical digital out connector to connect an audio decoder or audio/video processor.

Refer to the following illustration to connect optical digital out.

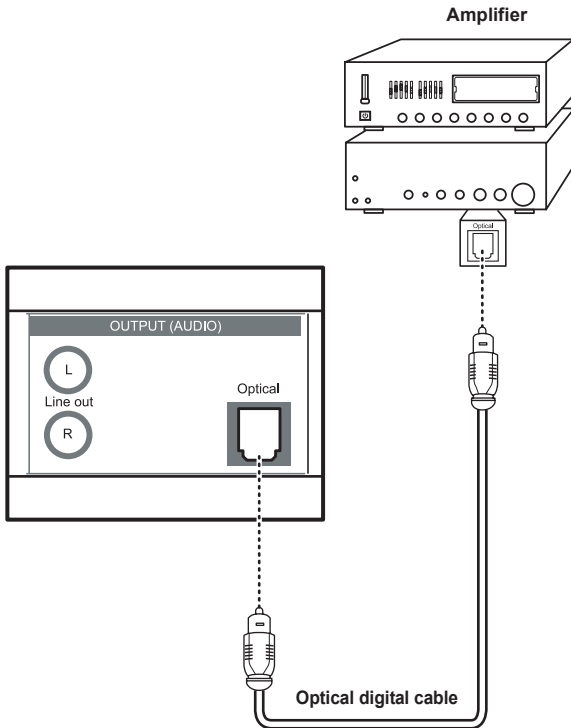

**Note:**

The supporting devices mentioned in this manual may vary on different models. For more information, please refer to the manufacturer's user manual or the Quick Start Guide of your TV model.

---

## 2.2.4 Connecting a Decoder/VCR/Recorder or DVD Player Using SCART (EU models only)

Use the SCART provided to connect a TV to a VCR, Recorder, DVD player or Decoder. Refer to the diagrams on the following page when reading the following instructions.

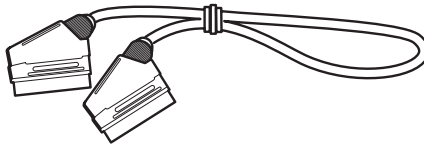

SCART cable

Connector	Input	Output (Monitor out)
AV1 (SCART1)	CVBS, RGB, and Audio L/R	TV/ AV1/ AV2/ AV3, and Audio L/R
AV3 (SCART2)	CVBS, S-Video, and Audio L/R	TV/ AV1/ AV2/ AV3, and Audio L/R

### Notes:

- The output function of AV3 is available only for selected models.
- The S-Video or CVBS input of AV3 is selected in the CUSTOMIZE menu of the OSD.

---

## 1. Connecting a VCR or Recorder:

- Connect the antenna cable to the TV input on the VCR/Recorder.
- Connect an output cable to the TV output on the VCR/Recorder and to the TV input at the back of the TV.
- Connect the SCART cable to the AV1 or AV3 input at the back of the TV and to the VCR/Recorder SCART connector. It is preferable with RGB output to AV1 as RGB provides better picture quality.
- Connect the decoder and recorder by SCART cable.

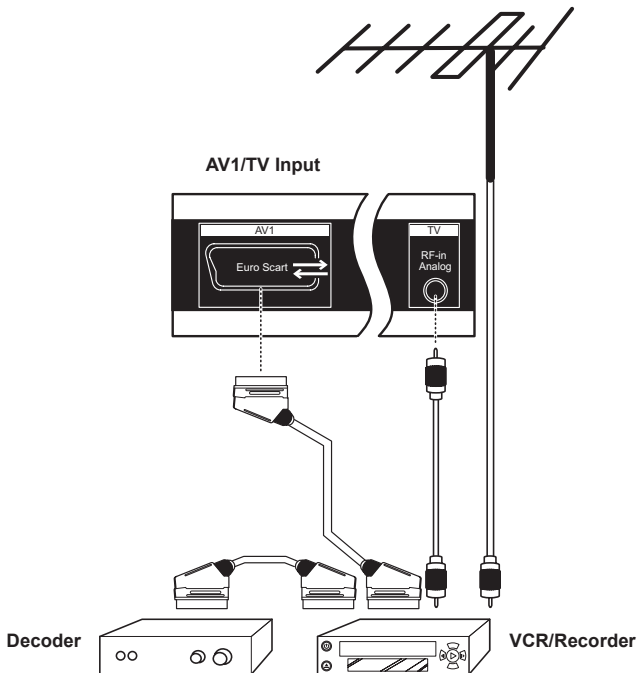

### Note:

The output function of AV3 is available only for selected models.

---

## 2. Connecting a SAT/STB:

- Connect the antenna cable to the SAT/STB.
- Connect the aerial cable from the SAT/STB TV out to the recorder TV in.
- Connect the aerial cable from the recorder TV out to the RF-in of the TV.
- Connect the SAT/STB to AV3 (or AV1) by SCART cable.
- Connect the recorder to AV1 (or AV3 for models with output function available) by SCART cable.

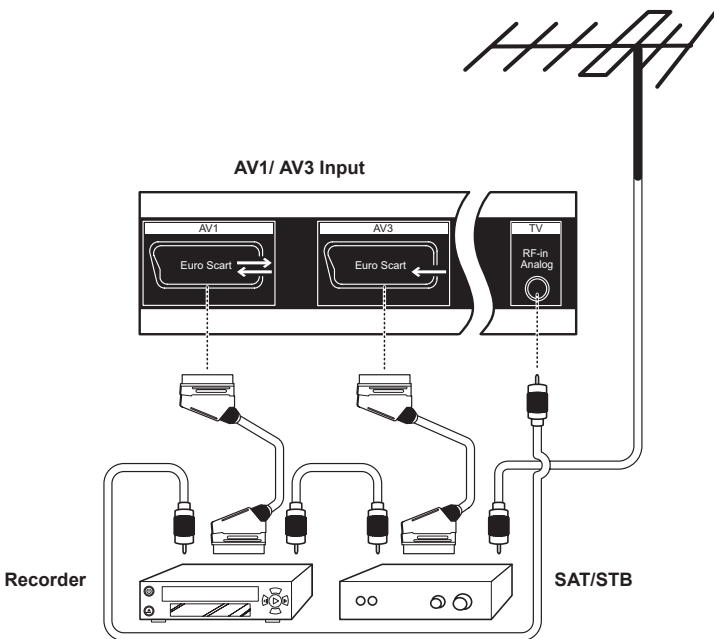

### Note:

For models with AV3 output function, it is recommended to swap the AV1/AV3 connection shown in the illustration.

---

### 3. Connecting a DVD Player:

- Connect the SCART cable to the AV1 or AV3 input at the back of the TV and to the SCART connector on the DVD player. It is preferable to connect peripherals with RGB output to AV1 as RGB provides a better picture quality.

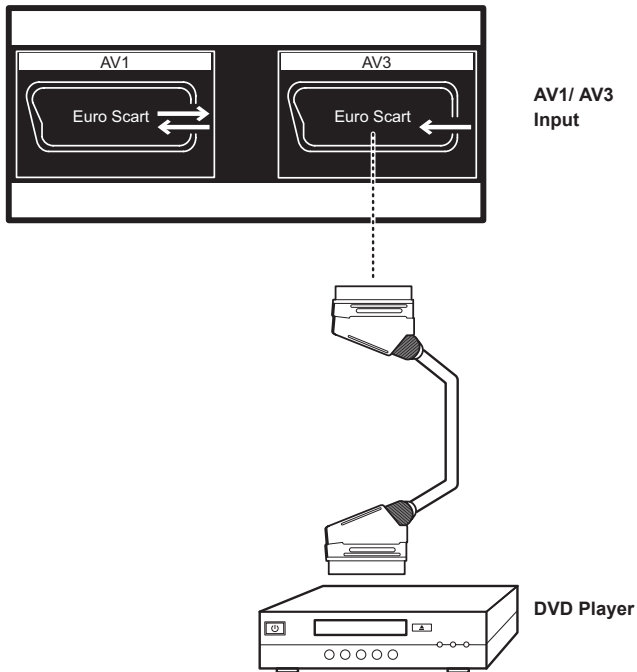

#### Note:

Refer to the user's manual included with the device for more detailed instructions.

## 2.2.5 Connecting a VCR/STB/DVD Player Using Component Video

The following illustration shows how to connect the TV to a VCR / STB / DVD player using the AV4 (for EU models) or AV4/AV5 (for AP models) component video ports. Actual connections may vary according to the make and model of your device.

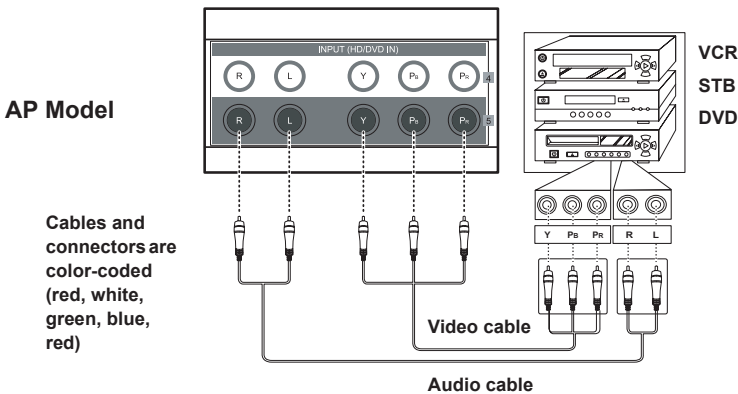
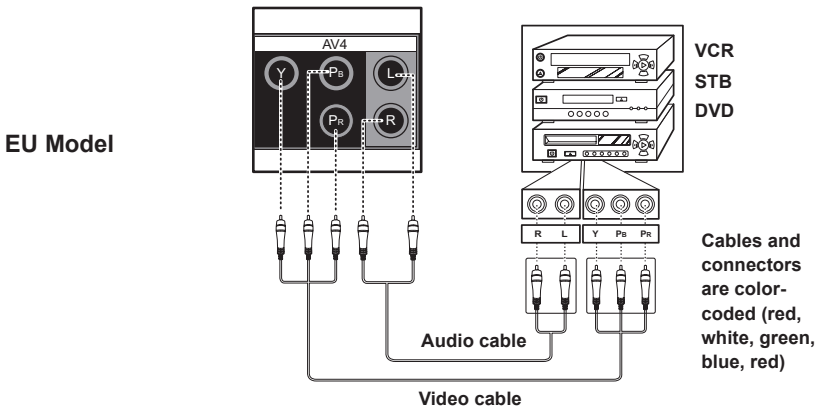

## 2.2.6 Connecting a VCR/STB/DVD Player Using Composite Video

The illustration presented here shows how to connect your TV to a VCR / STB / DVD player using the AV2 (for EU models) or AV1/AV2 (for AP models) composite video port. Actual connections may vary according to the make and model of your device.

**EU / AP Models**

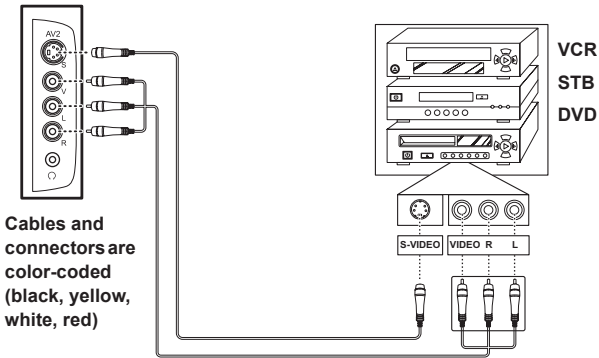

**AP Model**

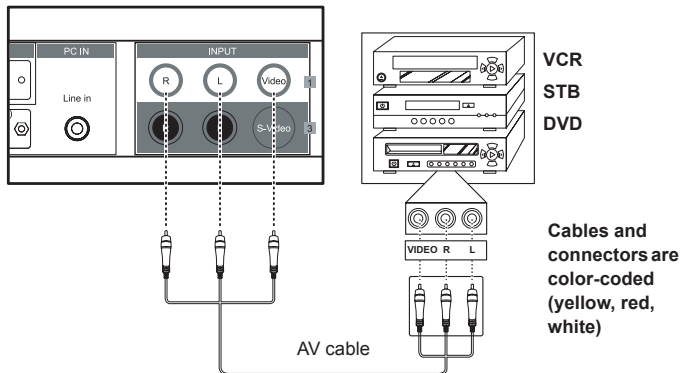



---

## 2.2.7 Connecting a Video Game Console

The following illustration shows how to connect the TV to a video game console using the AV2 port. Actual connections may vary according to the make and model of your device.

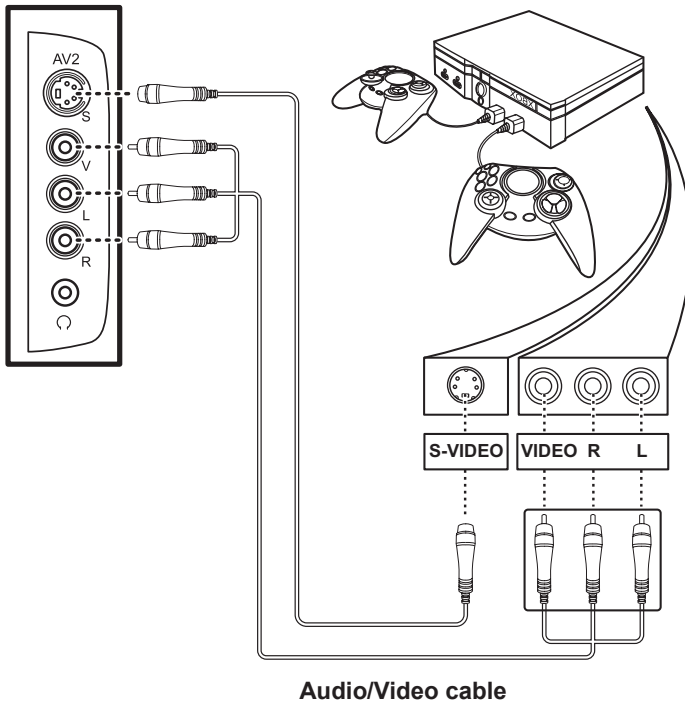

**Note:**

- When connecting the S-Video connector and AV connector at the same time, the priority is given to the S-Video connector.
- Location of the connectors varies according to the TV model. For more information, please refer to the manufacturer's user manual or the Quick Start Guide of your TV model.

---

## 2.2.8 Connecting a PC

Connect the TV to your PC to use it as the monitor using the D-Sub port as shown. Connect the D-Sub port of the TV to the D-Sub output of the PC. Connect the line out port of the PC to the line in port of your TV to listen to audio from the PC.

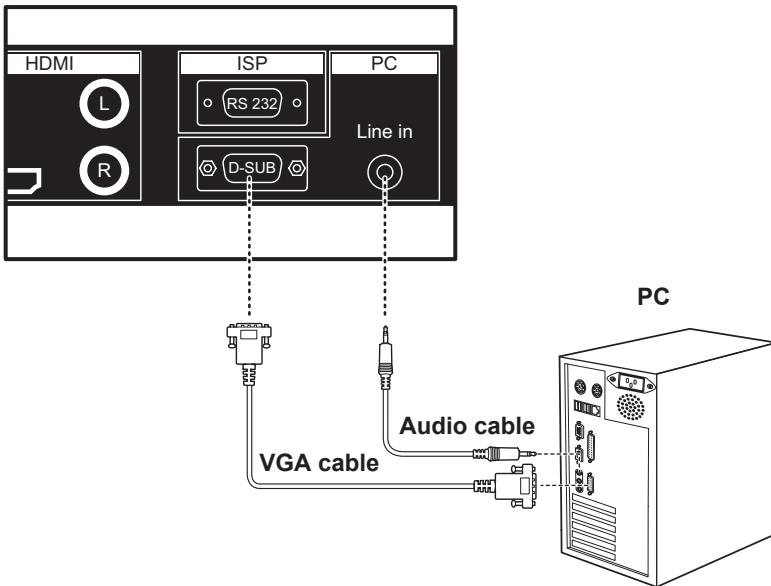

### Notes:

- Location of the connectors varies according to the TV model.
- For more information, please refer to the manufacturer's user manual or the Quick Start Guide of your TV model.

---

## 2.2.9 Connecting HDMI

HDMI (High Definition Multimedia Interface) with HDCP (High Definition Copy Protection) assures that the best video signal is always sent from source (HDTV signal, DVD player) to the TV.

Refer to the following illustration to connect an HDMI device to the TV.

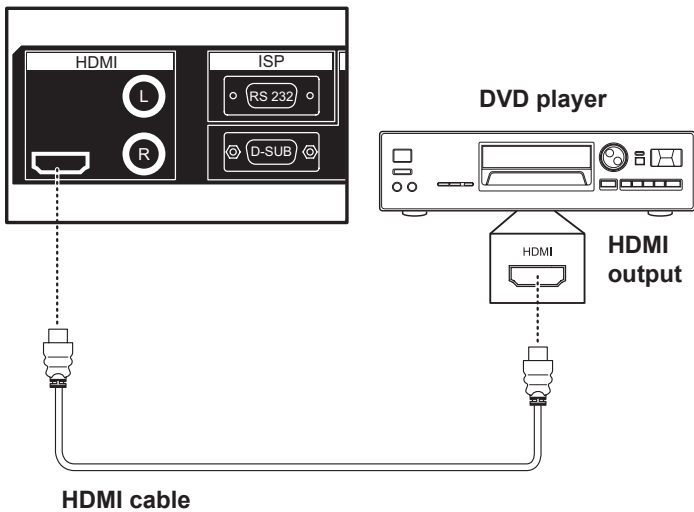

### Notes:

- When the HDMI cable is connected, connecting the audio cable is not necessary. However, it is necessary to do so if a HDMI-DVI-D cable is connected.

---

## 2.3 Inserting a Memory Card (For built-in E-Card only)

- 1 Insert the memory card(s) into the appropriate card reader slot(s) on the control panel of the TV as shown.

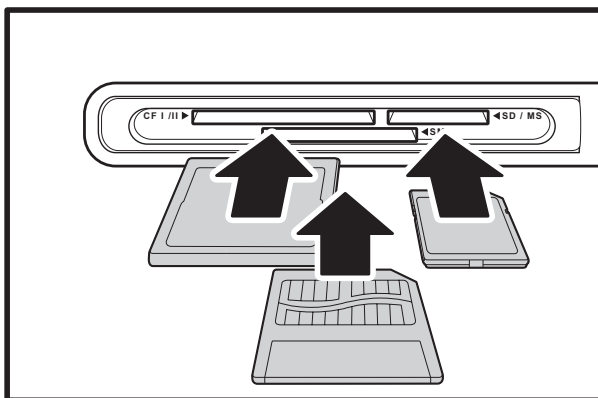

- 2 Push the card(s) gently until they stop. Make sure the card(s) are inserted in the correct way.
- 3 When inserted, the memory card(s) will protrude as shown.

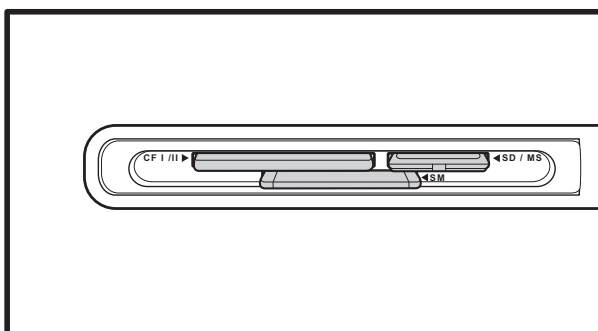

- 4 To remove a card, pull it from the card slot.

---

**Notes:**

- To prevent data loss, end tasks that retrieve data from the memory card before removing it from the card slot.
- Use only certified memory cards.
- Supports memory cards with a capacity of up to 1GB.
- Flash Card related functions and file names are only shown in English.
- Be careful when removing memory cards; removing them too quickly may result in damage to the card and possible data loss.
- Please refer the flash card website below:  
SM CARD: <http://www.ssfdc.or.jp/english/index.htm>  
SD CARD: <http://www.sdcard.org/>  
CF CARD: <http://www.compactflash.org/>  
MS CARD: <http://www.memorystick.com/en/>  
MMC CARD: <http://www.mmccard.org/>
- Supports play format: JPEG/MPEG, MPEG/II, MP3, MPEG4.

---

## 2.4 Using the TV

### 2.4.1 Using the Remote Control

For best results, use the remote control within a proper distance from the front of the TV. Do not exceed an angle of 30 degrees when pointing at the TV.

**Notes:**

- The operational distance may be shortened when the signal sensor is directly exposed to strong light.
- Aim the transmitter on the remote control at the signal sensor and ensure that there are no obstacles between them.

### 2.4.2 Turning the TV On and Off

1 Press  **Power** on the remote control or **POWER** on the control panel. The power LED indicator on the front of the TV changes from red to green, indicating that the power is on.

2 Press  **Power** or **POWER** again. The power LED changes from green to red, indicating that the TV is off.

### 2.4.3 Selecting Channels

- Press **CH▲** / **P▲** on the remote control or **CH▲** on the control panel to increase the channel number by one. Press **CH▼** / **P▼** or **CH▼** to decrease the channel number by one.
- Enter the specific channel number by pressing the number buttons on the remote control. The channel number is displayed on the screen.

---

## 2.4.4 Switching Source Signals

Press **SOURCE** on the control panel or **Source** on the remote control to select the incoming source signal. A screen appears with all sources listed. (Some of the sources are available only for selected models.)

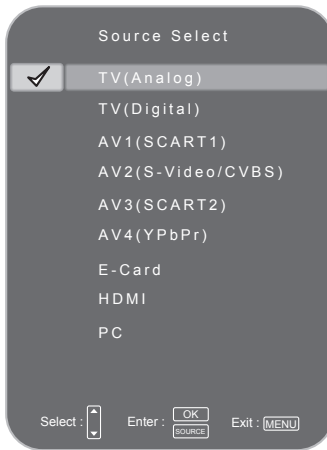

EU model screen

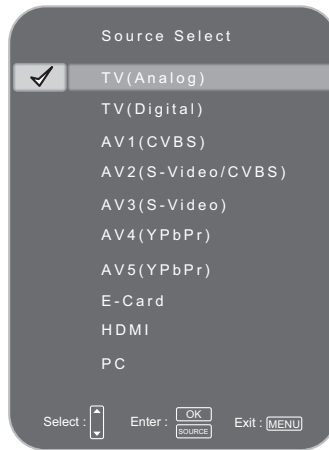

AP model screen

- 1 Press **▲ / ▼, CH▲ / CH▼** or **P▲ / P▼** on the remote control or **CH▲** or **CH▼** on the control panel to select the source you wish to use.
- 2 Press **OK** on the remote control or **SOURCE** on the control panel to confirm the setting.
- 3 Press **Menu** on the remote control or **MENU** on the control panel to exit.

---

## 2.4.5 Adjusting the Volume

- 1 Press **VOL+** to increase the volume.
- 2 Press **VOL-** to decrease the volume.
- 3 Press **Mute** to eliminate sound. A mute icon appears on the top left corner of the screen and sound is turned off.
- 4 Press **Mute** again or press the volume buttons to restore the original volume.



---

## 2.5 Using the E-Card Function (For built-in E-Card only)

The E-Card function enables you to view photos, watch movies, and listen to MP3 files on the memory card inserted in the card slot. The device supports Compact Flash (CF), Micro drive (MD), Smart Media (SM), Secure Digital (SD), Multi Media Card (MMC), and Memory Stick (MS-Pro) cards. Use the E-Card mode to view the contents.

The following describes the E-Card function:

- 1 Insert a memory card into the appropriate card slot. Refer to “Inserting a Memory Card (For built-in E-Card only)” on page 43.
- 2 Press **Source** on the remote control to display all available sources. Use the **▲ / ▼** button on the remote control to switch source to E-Card.
- 3 If more than one memory card is inserted to the card slots, a screen displaying the inserted cards is displayed. Use the **▲ / ▼** button on the remote control to select the memory card and press **OK**  to view the contents.

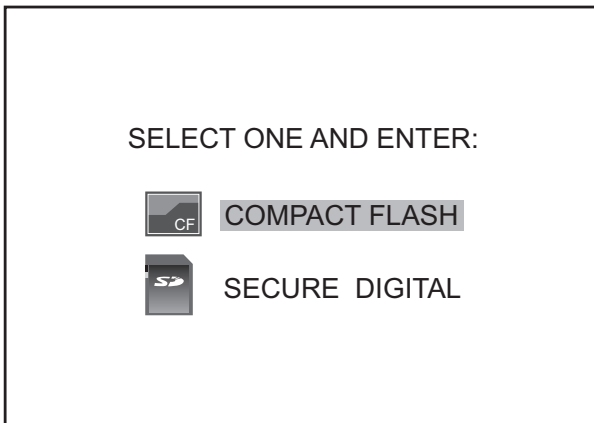

- 
- 4 The E-Card main screen appears. You can choose to view photos, listen to music, watch videos, or look at the contents of the memory card.

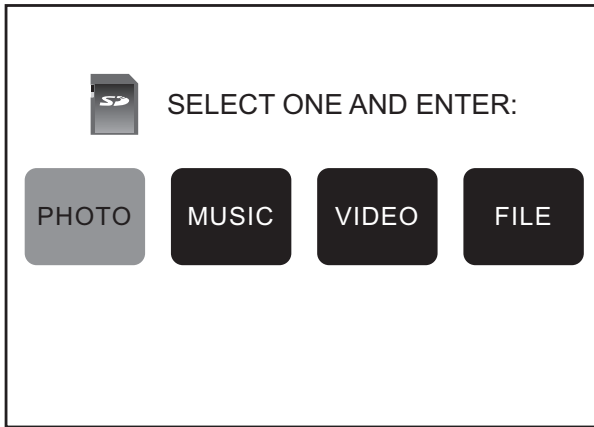









**E-Card main screen**





---

## 2.5.1 Remote Control Keys in E-Card Mode

The following table lists the remote control buttons used to operate the E-Card feature.

Button	Description	Function
	Cursor up / down / left / right	Press these buttons to navigate the E-Card menus. In Photo mode, use these buttons to pan a picture when zooming in.
	Play / Pause	Press this button to confirm a selection or to play/ pause a music / video file.
	Stop	Press this button to return to the E-Card main screen. In Music or Video mode, press to stop playing back a file.
	Slide Show	Press this button to start and stop the slide show.
	Zoom	Press this button to zoom in on a picture. (Magnification varies by input format).
	Rotate	Press this button to rotate a picture when in Photo mode.
	Previous	Press this button to play the previous file on the memory card.
	Next	Press this button to play the next file on the memory card.

---

Button	Description	Function
	Effect	Press this button to toggle between the EQ mode for music or photo slideshow mode.
	Repeat	Press this button to repeat the playing operation.
 Swap	Fast rewind	Press this button to fast rewind.
	Fast Foward	Press this button to fast forward.

---







## 2.5.2 Viewing Photos

- 1 When the E-Card main screen appears, use the ◀ / ▶ button on the remote control to select PHOTO.
- 2 Press **OK**  to display the thumbnails of images on the memory card.



- 3 Use the ▲ / ▼ / ◀ / ▶ button to select a thumbnail image.
- 4 Press **OK**  to expand the selected thumbnail to full screen mode.



- 
- 5** Press the  /  /  Hold button to go to the next picture. Press the  /  /  Twin button to go to the previous picture.



**Note:**

**If the image is not in the standard size/resolution (i.e. 800x600, 1024x768), it may appear deformed or with a blue/black background.**

## ***Zooming and Panning***

The E-Card function enables you to zoom in on images and pan the view. Follow these instructions.

- 1** View an image in full screen mode as described in the previous section.
- 2** Press  on the remote control to zoom in on the image. (Magnification varies by input format).

When zooming in on an image, press the  /  /  /  button on the remote control to pan the image.

## ***Rotating Images***

Follow these instructions to rotate images when in Photo mode.

- 1** View an image in full screen mode as described in the previous section.
- 2** Press  on the remote control.
- 3** The image is rotated 90 degrees (90°) in a clockwise direction.



**Note:**

**You cannot rotate an image when the image is being zoomed.**

---

## Viewing a Slide Show

The E-Card function has a slide show feature that enables you to view all the images by order.

- 1** Press **Last**  
Slideshow on the remote control to start the slide show.  
The files are viewed sequentially, and files in your music library are also played in sequence.
- 2** Press **Last**  
Slideshow again to stop the slide show.  
To pause a slide show, press **OK**  
 on the remote control.
- 3** Press  on the remote control to turn the repeat function on/off.  
Folder Repeat mode has the following options:
  - **ON:** runs the slide show again in the selected folder.
  - **OFF:** turns the folder repeat mode off.
- 4 Transition:** Press  on the remote control to choose different transition effects when playing the slide show.

---

## Transition Table

Transition	Description
<b>1</b> FULL SCREEN	Image appears full screen.
<b>2</b> ROLL: TOP TO BOTTOM	Image rolls in from top to bottom.
<b>3</b> ROLL: BOTTOM TO TOP	Image rolls in from bottom to top.
<b>4</b> ROLL: TOP/BOTTOM TO CENTER	Image rolls in from top and bottom to center.
<b>5</b> ROLL: CENTER TO TOP/BOTTOM	Image rolls in from center to top and bottom.
<b>6</b> BLIND: TOP TO BOTTOM	Image rolls in blinds from top to bottom.
<b>7</b> ROLL: LEFT TO RIGHT	Image rolls in from left to right.
<b>8</b> ROLL: RIGHT TO LEFT	Image rolls in from right to left.
<b>9</b> ROLL: LEFT/RIGHT TO CENTER	Image rolls in from left and right to center.
<b>10</b> ROLL: CENTER TO LEFT/RIGHT	Image rolls in from center to left and right.
<b>11</b> ROLL: IMplode	Image closes into center point.



---

## Transition Table

Transition	Description
<b>12</b> BLIND: LEFT TO RIGHT	Image rolls in blinds from left to right.
<b>13</b> CROSS FADE	Image fades in and out.
<b>14</b> SLIDE MODE: RANDOM	Transition effects are chosen randomly.

---

### 2.5.3 Listening to Music

- 1 When the E-Card main screen appears, use the ◀ / ▶ button on the remote control to select MUSIC.

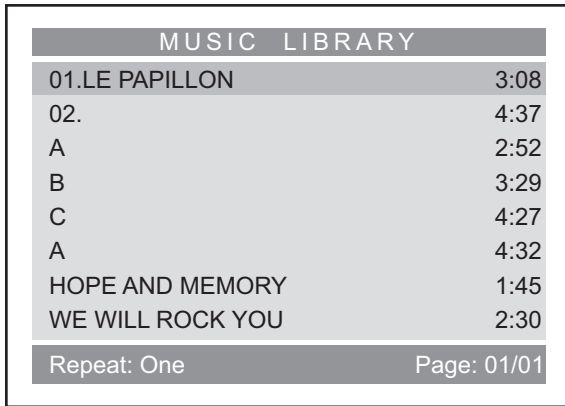

MUSIC LIBRARY	
01.LE PAPILLON	3:08
02.	4:37
A	2:52
B	3:29
C	4:27
A	4:32
HOPE AND MEMORY	1:45
WE WILL ROCK YOU	2:30
Repeat: One	
Page: 01/01	

- 2 Press **OK** . A screen appears displaying a list of the music stored on your memory card.
- 3 Use the ▲ / ▼ / ◀ / ▶ button to select a music file. The selected file starts playing. When the file finishes playing, the next file in the list is played.

- 
- 4 Press **OK**  to display the Music Equalizer screen. This screen enables you to view information about the file you are playing.

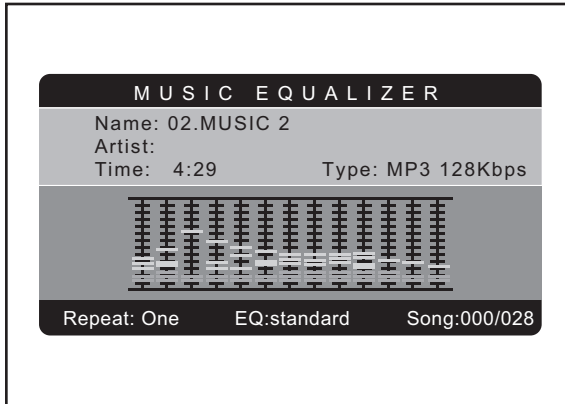

### ***Repeat mode***

Press  to switch among the following repeat modes:

- **ONE:** repeats one file
- **ALL:** repeats all files in sequence
- **OFF:** turns repeat mode off

### ***EQ mode***

Press  to toggle EQ mode:



- Choose from Jazz / Rock / Pops / Ballad / Dance / Standard / Classic

---

## 2.5.4 Watching Videos

- 1 When the E-Card main screen appears, use the ◀ / ▶ button on the remote control to select VIDEO.





- 2 Press **OK** . A screen appears displaying thumbnails of the videos on your memory card.
- 3 Use the ▲ / ▼ / ◀ / ▶ button on the remote control to select a video file.
- 4 Press **OK** . The selected video file begins playing.

---

## 2.5.5 Viewing Memory Card Files

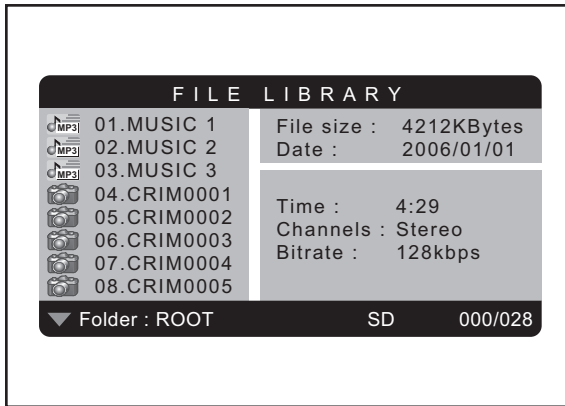
- 1 When the E-Card main screen appears, use the ◀ / ▶ button on the remote control to select FILE.



- 2 Press **OK** . A screen appears displaying a list of the files on your memory card. The file type is denoted by the icons, and the file size, creation date, and thumbnail view of the file provides additional information.
- 3 Use the ▲ / ▼ / ◀ / ▶ button to select a file and press **OK** . The selected file is displayed or played.

# 3

## Adjusting On-Screen Display (OSD) Settings

---

The On-Screen Display (OSD) menu system provides a quick and simple method to adjust the TV settings. This chapter describes how to change each of the available settings. The OSD menu can be accessed through the buttons either on the front control panel or the remote control.

Function	TV Control Panel	Remote Control
OSD Menu	<b>MENU</b>	<b>Menu</b>
Up	<b>CH ▲</b>	<b>▲ / CH ▲ / P ▲</b>
Down	<b>CH ▼</b>	<b>▼ / CH ▼ / P ▼</b>
Add/Enter	<b>VOL +</b>	<b>▶ / VOL+</b>
Decrease	<b>VOL -</b>	<b>◀ / VOL-</b>
Return	<b>SOURCE</b>	<b>OK</b> <b>▶   / Source</b>

### 3.1 OSD Setting Menus

#### Menu Icon Description

---



Enables you to make adjustments to picture settings such as brightness, contrast, saturation, sharpness, hue, and create custom configurations.

#### VIDEO

---



Enables you to adjust audio characteristics such as bass and treble, and also enables enhanced audio options such as Surround.

#### AUDIO

---



In PC mode, enables you to set characteristics such as phase and clock.

#### PC

---



Enables you to choose TV or CATV, autoscan for channels, add and delete channels, and edit channel names.

## TV

---



Enables you to set the OSD language, set the sleep timer and enable closed captions.

## CUSTOMIZE

---

### Notes:

- Press **Menu/ MENU** to exit the menus at any time.
- You can control the OSD with either the remote control or the TV control panel.
- The new setting is confirmed automatically when the OSD times out.

## 3.2 Adjusting Video Settings

Press **Menu** to enter the OSD Main Menu screen.

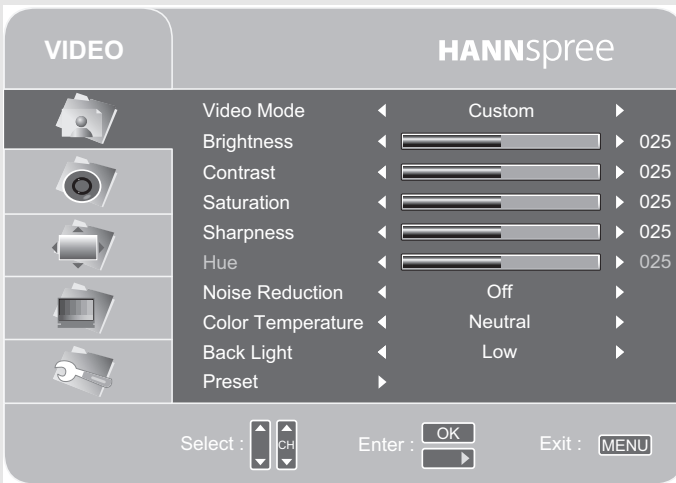

- 1 Press **OK** or **▶** to enter the VIDEO Menu.
- 2 Press **▲ / ▼**, **CH▲ / CH▼** or **P▲ / P▼** to select an option.
- 3 Press **◀** or **▶** to change the mode setting.
- 4 Press **OK** to select the changed setting and return to the VIDEO Menu.
- 5 Press **Menu** to exit the VIDEO menu.



---

The Video Mode menu includes the following options.

Option	Description
Video Mode	Enables you to customize the video display. The following options are available:
	Vivid      Sets the display for enhanced picture contrast and saturation.
	Standard   Sets the display for normal viewing (default).
	Soft        Sets the display for mild sharpness.
	Custom     Enables you to set user defined values.
	<b>Note:</b> <b>When the source is set to PC, only Custom is available.</b>
Brightness	Brightens or darkens the picture.
Contrast	Increases or decreases the contrast. Increasing the contrast makes the colors deeper. Decreasing the contrast makes the colors softer.
Saturation	Adjusts the intensity of the color.
Sharpness	Sharpens or softens picture clarity. Decrease this value to make the pictures softer.
Hue	Increases or decreases the red tint.
	<b>Note:</b> <b>The hue adjustment is available for NTSC input source only.</b>

Option	Description						
Noise Reduction	<p>Noise reduction enables you to reduce the amount of interference in the signal. The following options are available:</p> <ul style="list-style-type: none"> <li>• High</li> <li>• Middle</li> <li>• Low</li> <li>• Off</li> </ul> <p><b>Note:</b>  <b>Noise reduction only works in TV and AV1 ~ AV3 modes.</b></p>						
Color Temperature	<p>Color temperature refers to the warm or cool feeling of a color, rather than actual temperature. The following options are available:</p> <table border="0"> <tr> <td data-bbox="367 850 460 879">Cold</td> <td data-bbox="512 850 1002 879">Gives white colors a bluish tint.</td> </tr> <tr> <td data-bbox="367 884 460 912">Neutral</td> <td data-bbox="512 884 1002 912">Gives white colors a neutral tint.</td> </tr> <tr> <td data-bbox="367 917 460 946">Warm</td> <td data-bbox="512 917 1002 946">Gives white colors a reddish tint.</td> </tr> </table>	Cold	Gives white colors a bluish tint.	Neutral	Gives white colors a neutral tint.	Warm	Gives white colors a reddish tint.
Cold	Gives white colors a bluish tint.						
Neutral	Gives white colors a neutral tint.						
Warm	Gives white colors a reddish tint.						
Back Light	Sets the LCD backlight. Set this to low to conserve power.						
Preset	Erases all customized video settings and returns all values to factory defaults.						

### 3.3 Adjusting Audio Settings

Press **Menu** to enter the OSD Main Menu screen.

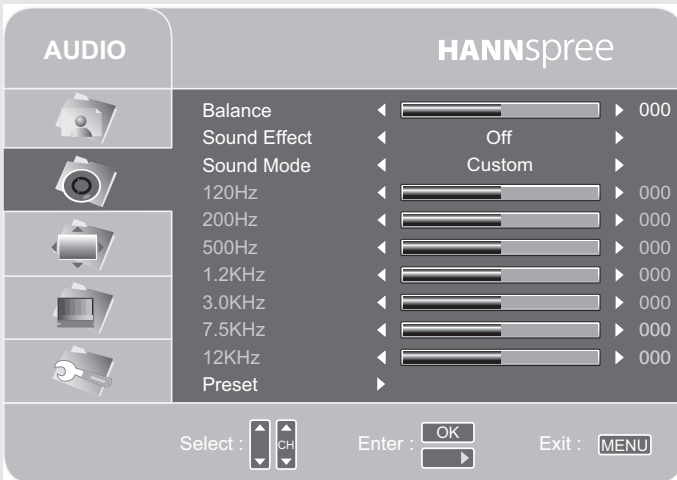

- 1 Press **OK** or **▶** to enter the AUDIO Menu.
- 2 Press **▲ / ▼**, **CH▲ / CH▼** or **P▲ / P▼** to select an option.
- 3 Press **◀** or **▶** to change the mode setting.
- 4 Press **OK** to select the changed setting and return to the AUDIO Menu.
- 5 Press **Menu** to exit the AUDIO menu.

---

The Audio Mode menu includes the following options.

Option	Description
Balance	Changes the balance between the left and right speakers.
Sound Effect	Toggles between the TruSurround XT and BBE ViVA HD3D sound features.
Sound Mode	Enables you to toggle between sound modes: <ul style="list-style-type: none"><li>• Off</li><li>• Music</li><li>• Speech</li><li>• Jazz</li><li>• Concert</li><li>• Movie</li><li>• Custom</li></ul> <p><b>Note:</b> This function is only available when sound effect is off.</p>
Equalizer Bars: 120Hz 200Hz 500Hz 1.2KHz 3.0KHz 7.5KHz 12KHz	Enables you to adjust equalizer settings for each of these individual frequencies.
Preset	Erases all customized audio settings and return all values to factory defaults.

### 3.4 Adjusting PC Settings

If a PC is connected, the PC mode menu items become available. The PC Mode menu includes the following options.

Press **Menu** to enter the OSD Main Menu screen.

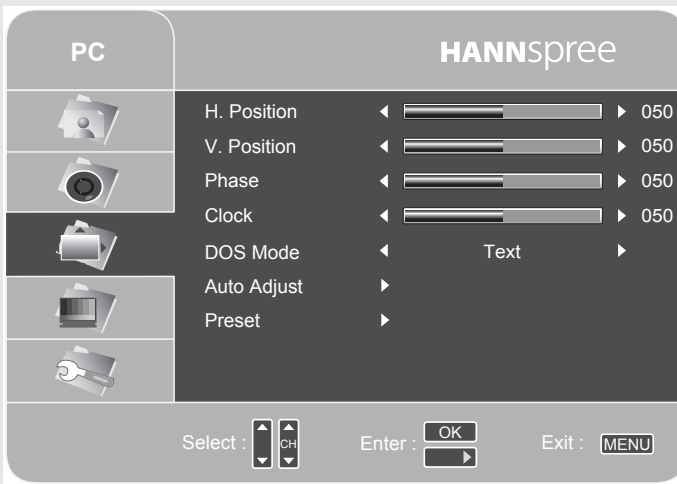

- 1 Press **OK** or **▶** to enter the PC Menu.
- 2 Press **▲ / ▼**, **CH▲ / CH▼** or **P▲ / P▼** to select an option.
- 3 Press **◀** or **▶** to change the mode setting.
- 4 Press **OK** to select the changed setting and return to the PC Menu.
- 5 Press **Menu** to exit the PC menu.

---

The PC Settings menu includes the following options:

Option	Description
H. Position	Press ◀ or ▶ to adjust the horizontal position of the display.
V. Position	Press ◀ or ▶ to adjust the vertical position of the display.
Phase	Press ◀ or ▶ to adjust the phase timing.
Clock	Press ◀ or ▶ to adjust the clock timing.
DOS Mode	Select the optimal display timing for DOS mode. Text        For text content Graphic     For graphic content
Auto Adjust	Press ▶ to allow the TV to adjust the display automatically for best results.
Preset	Press ▶ to erase all customized PC settings and return all values to factory defaults.

**Note:**

**The display resolution is based on the PC input signal.**

### 3.5 Adjusting TV Settings

Press **Menu** to enter the OSD Main Menu screen.

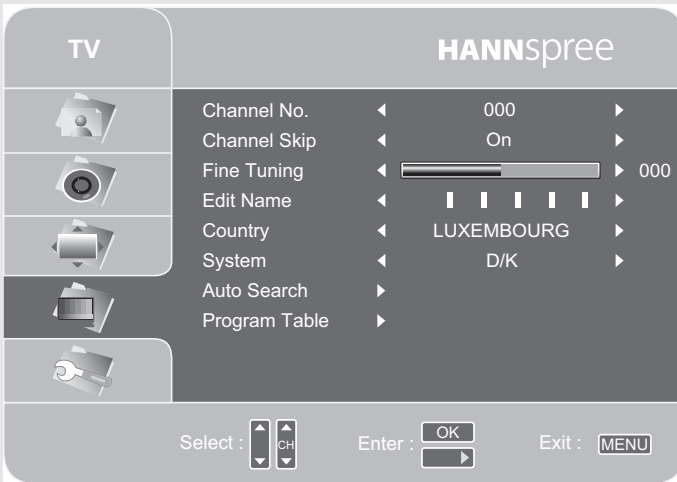

- 1 Press **OK** or **▶** to enter the TV Menu.
- 2 Press **▲ / ▼**, **CH▲ / CH▼** or **P▲ / P▼** to select an option.
- 3 Press **◀** or **▶** to change the mode setting.
- 4 Press **OK** to select the changed setting and return to the TV Menu.
- 5 Press **Menu** to exit the TV menu.

---

The TV Mode menu includes the following options:

Option	Description
Channel No.	Use to select a channel to adjust its settings.
Channel Skip	Select <b>ON</b> to remove the selected channel number from the channel list. Select <b>OFF</b> to add the selected channel number to the channel list.
Fine Tuning	Select this item and press ◀ or ▶ to fine tune a channel for better picture quality.
Edit Name	Use the alphanumeric keypad on the remote control to enter a name for the channel. You can use up to six alphanumeric characters for the name.
Country	Select the preset channel table according to the country. <b>Note: If the desired country is not shown in the list, choose 'All' instead.</b>
System	Use this to select your TV system. Four systems are available: <ul style="list-style-type: none"><li>• <b>B/G</b></li><li>• <b>I</b></li><li>• <b>D/K</b></li><li>• <b>L</b></li></ul>
Auto Search	Select this option to begin auto search. The TV will search for all available channels and add them to the channel list. Press <b>Menu</b> to abort the scan while in progress.



---

**Option****Description**

Allows you to view and edit all stored channels.

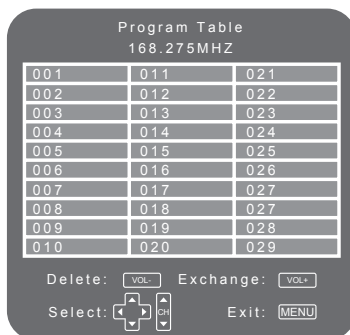
**Program Table****To delete a channel from the list:**

- 1 Press **▲ / ▼ / ◀ / ▶** to select the channel you want to delete.
- 2 Press **VOL-** to delete.
- 3 Press **Menu** to exit.

**To change channel positions in the list:**

- 1 Press **▲ / ▼ / ◀ / ▶** to select the channel you want to move.
- 2 Press **VOL+** to lock the channel.
- 3 Press **▲ / ▼ / ◀ / ▶** to move the channel to the desired new location.
- 4 Press **VOL+** to confirm the change.
- 5 Press **Menu** to exit.

### 3.6 Adjusting Customize Settings

Press **Menu** to enter the OSD Main Menu screen.



- 1 Press **OK** or **▶** to enter the CUSTOMIZE Menu.
- 2 Press **▲ / ▼**, **CH▲ / CH▼** or **P▲ / P▼** to select an option.
- 3 Press **◀** or **▶** to change the mode setting.
- 4 Press **OK** to select the changed setting and return to the CUSTOMIZE Menu.
- 5 Press **Menu** to exit the CUSTOMIZE menu.

---

The Customize Settings menu includes the following options:

Option	Description
Language	Select from the following language options: <ul style="list-style-type: none"><li>• English</li><li>• Español</li><li>• Français</li><li>• 繁體中文</li></ul> <p><b>Note:</b> <b>OSD language may vary from region to region.</b></p>
Background	Enables you to set the OSD background to be translucent or solid.
SCART2 Input	Select the input signal type of SCART2 between <b>CVBS</b> and <b>S-Video</b> .
Preset	Erases all customized settings and return all values to factory defaults.

# 4

## Using POP

---

The TV features POP (Picture Outside Picture) that enables you to view two sources at the same time.

- 1 Press  to open the double windows, which play the independent content from two different input sources.



- 2 Press  to activate the left window for source selection. Press **Source** to select the incoming source signal, as described in “Switching Source Signals” on page 46.

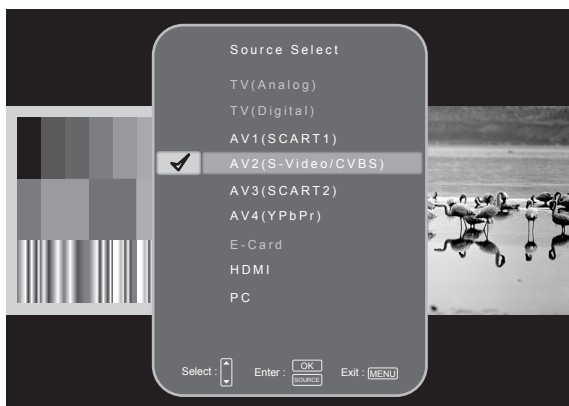

### Left Window

- All sources can be selected, except TV and E-Card.

### Right Window

- Fixed at TV mode.
- Press **▲ / ▼**, **CH▲ / CH▼** or **P▲ / P▼** on the remote control or **CH▲** or **CH▼** on the control panel to change the channel.

### Note:

In E-Card mode (for selected models), the POP function is not available.

- 3 Press **Swap** to switch the audio output from the activated window (marked with a blue frame).
- 4 Press **Twin** to disable the POP function and return to the normal display.

**Note:** Some features (for example, 'Wide' and 'Hold') on the remote control unit are not available in POP mode.

# 5

## Troubleshooting

Situation	Solution
No picture and sound.	<ul style="list-style-type: none"><li>• Connect the power cord properly.</li><li>• Check if the power LED is on or not.</li><li>• Press power on the control panel or remote control.</li><li>• Press source to cycle through connected video sources.</li><li>• Press channel up or channel down to switch to other TV stations.</li><li>• Make sure all cables are connected properly.</li></ul>
No picture, or poor picture, sound is OK.	<ul style="list-style-type: none"><li>• Check the antenna and cable connections.</li><li>• Adjust the brightness in the OSD menus. See "Brightness" on page 64.</li></ul>
Picture is not in color.	<ul style="list-style-type: none"><li>• Adjust the saturation in the OSD menus. See "Saturation" on page 64.</li></ul>
Picture is OK, no sound.	<ul style="list-style-type: none"><li>• Make sure the source device is functioning properly.</li><li>• Make sure the audio cable is connected securely.</li><li>• Turn the mute off.</li><li>• Press volume up on the control panel or remote control.</li></ul>
One of the speakers has no sound.	<ul style="list-style-type: none"><li>• Adjust the balance in the OSD menus. See "Balance" on page 67.</li></ul>
Cannot receive some TV channels using cable TV.	<ul style="list-style-type: none"><li>• Try the Auto Program function in the OSD "TV Setting" menu. See "Auto Search" on page 71.</li></ul>
Want to reset TV settings.	<ul style="list-style-type: none"><li>• Use the Preset function in the OSD menu.</li></ul>
Cannot operate menus.	<ul style="list-style-type: none"><li>• If OSD items are colored in gray, the system is in a state such that those settings are not available.</li></ul>
Screen image turns over.	<ul style="list-style-type: none"><li>• Make sure the video signal cable is connected properly.</li></ul>

Situation	Solution
Snow appears on the screen.	<ul style="list-style-type: none"> <li>• Adjust the location of the antenna, placing it far from roads or sources of interference.</li> <li>• Check the antenna and the video signal line connections.</li> </ul>
Blurred or overlapped images.	<ul style="list-style-type: none"> <li>• Readjust the sharpness setting.</li> <li>• Choose programs with high quality signals.</li> <li>• Adjust the direction of the antenna or change the video signal cable.</li> </ul>
Remote control doesn't work.	<ul style="list-style-type: none"> <li>• Make sure the battery is inserted correctly.</li> <li>• Replace the battery with a new one.</li> <li>• Make sure the TV power cord is plugged in.</li> <li>• Make sure the path between the remote control and the sensor is clear.</li> <li>• Try operating the remote control at a closer distance to the TV. Refer to "Using the Remote Control" on page 45.</li> </ul>

# 6

## **Warranty and Service**

---

For complete warranty service information, please refer to the “Warranty and Service Manual” enclosed with your TV.



## Specifications

LCD Panel Size	26/32/37 inch TFT	
Aspect Ratio	16:9	
Best Resolution	1366 (horizontal) x 768 (vertical)	
TV System	EU: PAL-B/G D/K I SECAM-L	AP: PAL-B/G D/K I
Video System	AV1 (SCART): RGB/CVBS with Video out AV2: S-Video/CVBS AV3 (SCART): S-Video/CVBS with optional video out AV4: YPbPr E-Card (Selected models only) HDMI Ver 1.1 PC	AV1: CVBS AV2: S-Video/CVBS AV3: S-Video AV4: YPbPr AV5: YPbPr E-Card (Selected models only) HDMI Ver 1.1 PC
Audio System	AV1, AV3, HDMI (integrated audio) AV2, AV4, HDMI: L/R RCA jacks (audio input) 3.5 mm earphone out PC Line-in Optical out E-Card (Selected models only)	AV1, AV2, AV3, AV4, AV5, HDMI: L/R RCA jacks (audio input) 3.5 mm earphone out PC Line-in Optical out E-Card (Selected models only) Subwoofer out
Built-in Stereo Speakers Output	26"/32" - 8 W x 2, 37" - 15 W x 2	
Power Supply	100-240V, 50/60 Hz	
Power Consumption	26"/32" - 200W (max.) 37" - 250W (max.)	
Component Format	480i, 480p, 576i, 576p, 720p, 1080i	

---

## 7.1 PC Mode Support Timing

	Pixel Format	Hor. Freq. (kHz)	Hor. Polarity	Ver. Freq. (Hz)	Vertical Polarity	Standard
1	640*480	31.47	-	60	-	VESA
2	640*480	37.861	-	72	-	VESA
3	640*480	37.5	-	75	-	VESA
4	800*600	35.156	+	56	+	VESA
5	800*600	37.879	+	60	+	VESA
6	800*600	48.077	+	72	+	VESA
7	800*600	46.875	+	75	+	VESA
8	1024*768	48.363	-	60	-	VESA
9	1024*768	56.476	-	70	-	VESA
10	1024*768	60.023	+	75	+	VESA
11	640*400	31.47	-	70	+	DOS-G
12	720*400	31.47	-	70	+	DOS-Text

**Broadcast TV:** Broadcasting video signals using high-frequency electromagnetic waves to distribute television channels to viewers (standard TV broadcast).

**CATV:** Community Antenna Television, the original name for cable TV. A television distribution system that uses coaxial cable instead of the traditional radio broadcasting (over-the-air) method to deliver television, FM radio, and other services to consumers.

**Color Temperature:** Adjusting the color temperature enables you to set the intensity of white light. Color temperature is measured in Kelvin (K). Higher color temperatures result in a blue tint. Lower temperatures result in a red tint.

**Hue:** Colors in a color system are measured by hue, saturation and luminance. Hue indicates the predominant color.

**LCD (Liquid Crystal Display):** A display technology that uses rod-shaped molecules (liquid crystals) that flow like liquid and bend light.

**Saturation:** Chromatic purity indicating the amount of white contained in a color. Fully saturated colors are pure colors; less saturated colors appear as pastel shades.

**Stereo:** The default audio signal belonging to a particular channel.

**S-Video:** Separate video, a video cabling standard used to transmit video by keeping brightness (Y) and color information (C) on separate channels. Most often used with camcorders.

## **HANNSPREE CALIFORNIA, INC.**

TEL: 1-510-360-3080

Toll Free : 1-888-808-6789

FAX:1-510-360-3001

Corporate website :

<http://www.hannspree.com/us>

Service website :

<http://usservice.hannspree.net>

Service Email :

[webservice\\_us@hannspree.com](mailto:webservice_us@hannspree.com)

## **Australia**

Phone: 1-300-HANNSPREE (1-300-426677)

Corporate website :

<http://www.hannspree.com/au>

Service website :

<http://auservice.hannspree.net>

## **New Zealand**

Phone: 0-800-HANNSPREE(0-800-426677)

Corporate website :

<http://www.hannspree.com/nz>

Service website :

<http://nzservice.hannspree.net>

## **Europe GmbH**

TEL: +49 (0) 2154 953 23-0

FAX: +49 (0) 2154 953 23-123

Corporate website :

<http://www.hannspree.com/eu>

Service website :

<http://euservice.hannspree.net>

## **瀚斯寶麗股份有限公司**

電話：886-2-87518000

傳真：886-2-87514755

Corporate website :

<http://www.hannspree.com/tw>

Service website :

<http://twservice.hannspree.net>

## **瀚斯宝丽科技(上海)有限公司**

电话: +86.21.3912.6999

传真: +86.21.3912.6969

Corporate website :

<http://www.hannspree.com/cn>

Service website :

<http://cnservice.hannspree.net>

## **Hannspree Hong Kong Service Center**

TEL: (852) 23453822

FAX: (852) 23453790

Corporate website :

<http://www.hannspree.com/hk>

Service website :

<http://hkservice.hannspree.net>

## **Japan**

電話番号: 03.6914.5088

ブアクス: 03.6914.5087

Corporate website :

<http://www.hannspree.com/jp>

Service website :

<http://jpservice.hannspree.net>

