

Contents

Remote Control Buttons	2
TV Appearance	3
Control Panel Buttons and Connection Sockets	4
Features	5
Panel Features	5
Safety Precautions	5
Preparation	7
Before Switching On Your TV	7
Power Connection	7
Connections To The RF Input Socket ..	7
How To Connect Other Devices	7
Inserting Batteries In The Remote Control Handset	7
Switching The TV ON/OFF	8
To switch the TV on	8
To switch the TV off:	8
Initial Settings	8
Basic Operations	9
Everyday Operation	10
Information Banner	10
ELECTRONIC PROGRAMME GUIDE (EPG)	11
Displaying The Subtitles	12
Digital Teletext	12
Over Air Download	12
Widescreen	12
IDTV Menu System	13
Channel List	13
Installation	15
Configuration	16
Timers	18
Language	19
TV Setup	19
Common Interface	20
Analogue TV Menu System	21
Picture Menu	21
Window Menu	22
Audio Menu	23
Options Menu	24
Settings Menu	25
Source Select	28

Other Features (Analogue TV)	28
TV Status	28
Freeze Picture	29
Sound Indicator	29
Mute Indicator	29
AV Modes	29
“HD Ready”	29
Teletext	30
Connect Peripheral Equipment	32
Via The Euroconnector	32
Via Ant Input	32
Decoder (optional)	32
TV And Video Recorder	32
Playback NTSC	32
Copy Facility	32
Search For And Store The Test Signal Of The Video Recorder	32
Camera And Camcorder	33
Connect The Decoder To The Video Recorder	33
Connecting Headphones	33
PC Sound Connection	33
Connecting the PC via VGA input	33
Connecting YPbPr (Component) via VGA input	33
Connecting the PC via DVI (Digital Video Interface) input	33
How to connect HDMI via DVI input ..	33
Antenna Connections	34
Peripheral Equipment Connections	34
PC Input Typical Display Modes	35
DVI INPUT TYPICAL DISPLAY MODES ..	35
Tips	36
Specifications	37
Important Instruction	38

Remote Control Buttons

- ① = Stand By
- ② = Cursor Up
- ③ = Cursor Right
- ④ **OK / SELECT** = Okay, Freeze (In Analogue Broadcast)
- ⑤ **0 - 9** = Direct Programme
- ⑥ **BACK** = MENU Quit
- ⑦ **SWAP** = Programme swap / Source swap
- ⑧ **P/CH +** = Programme Up
- ⑨ = Volume Up
- ⑩ = TV / IDTV mode (To change between Analogue-Digital broadcast)
- ⑪ **SOURCE** = External source
- ⑫ **YELLOW ***
- ⑬ **BLUE ***
- ⑭ = Hold / PIP position (No function)
- ⑮ = Update / Split screen (No function)
- ⑯ / **GUIDE** = Index Page / Electronic Programme Guide (EPG)
- ⑰ = Reveal / PIP size (No function)
- ⑱ **WIDE** = Expand / Image size
- ⑲ = Mix, = PIP on / PIP off (No function)
- ⑳ = Teletext
- ㉑ = Time / Subpage
- ㉒ / **RED** = Page Down / *
- ㉓ / **GREEN** = Page Up / *
- ㉔ = Mute
- ㉕ **I-II** = Mono/Stereo - Dual A-B
- ㉖ = Volume Down
- ㉗ **- P/CH** = Programme Down
- ㉘ **P<P** = Previous Programme (Analogue mode)
- ㉙ **INFO** = Information button (Program Table)
- ㉚ **M / MENU** = Menu
- ㉛ = Cursor Down
- ㉜ = Cursor Left

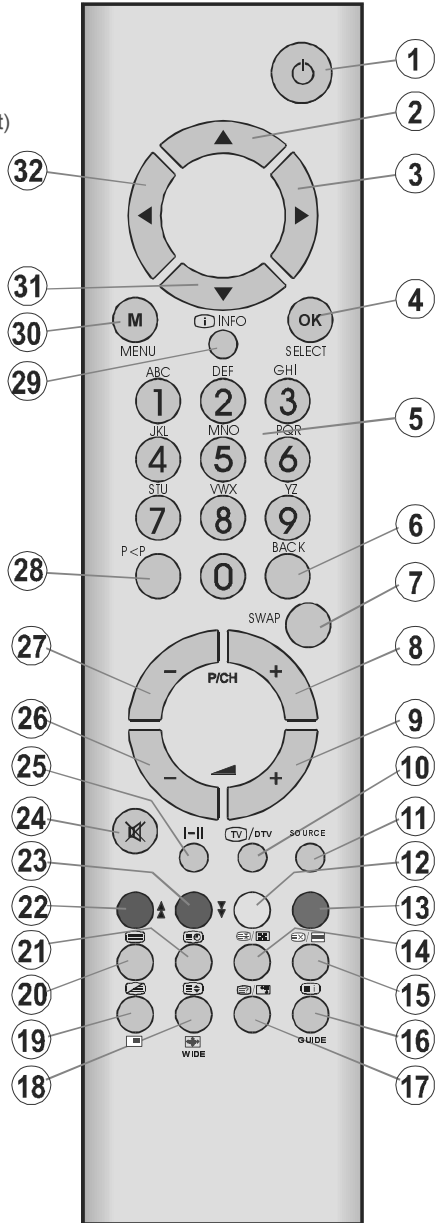

* Coloured buttons are used in ELECTRONIC PROGRAMME GUIDE (7 Day) menu navigation, and in digital teletext.

TV Appearance

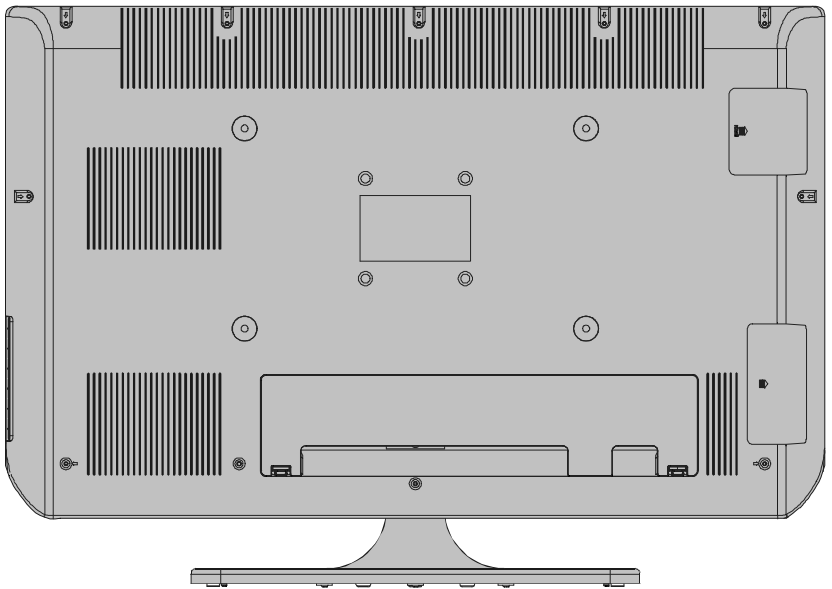
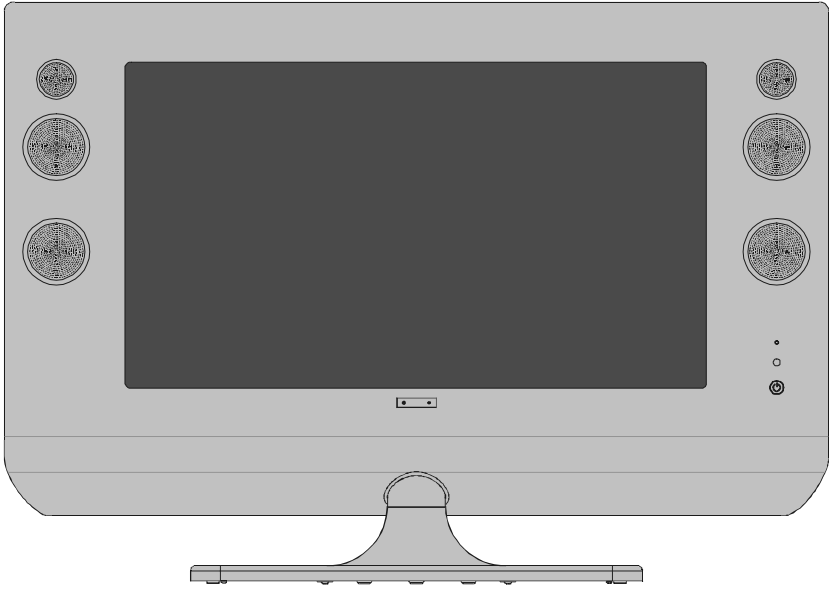

Control Panel Buttons and Connection Sockets

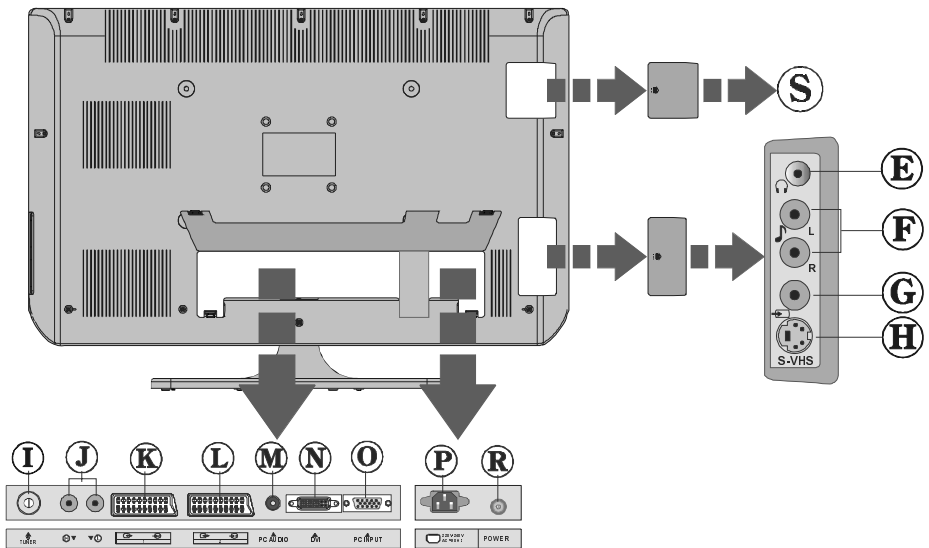
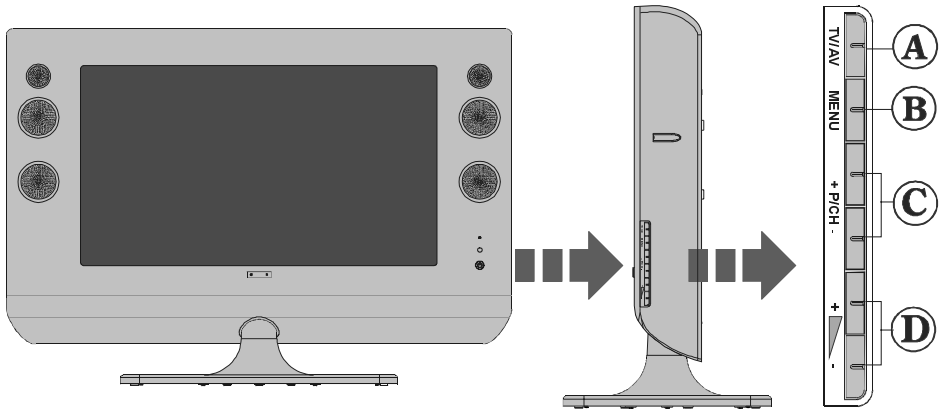

- Ⓐ TV/AV button
- Ⓑ MENU button
- Ⓒ Program Up, Program Down buttons
- Ⓓ Volume Up, Volume Down buttons

- Ⓔ Headphone
- Ⓕ Audio Input (Left, Right)
- Ⓖ Video Input
- Ⓗ S-VHS Input
- Ⓘ Antenna

- Ⓙ Audio Line Out L, R
- Ⓚ Scart Socket 1 (AV-1)
- Ⓛ Scart Socket 2 (AV-2)
- Ⓜ PC Audio In (for VGA)
- Ⓝ DVI Input
- Ⓞ PC Input
- Ⓟ Power cord input
- Ⓡ On/Off switch
- Ⓢ CI (Common Interface) Slot

Features

- It is a remote controlled colour television.
- 100 programmes from VHF, UHF bands or cable channels can be preset.
- It can tune cable channels.
- Controlling the TV is very easy by its menu driven system.
- It has 2 Euroconnector sockets for external devices (such as video, video games, audio set, etc.)
- Stereo sound system (German+Nicam).
- Full function Teletext .
Fastext (10 Pages), TOP text.
- It is possible to connect headphone.
- Direct channel access.
- Automatic Programming System.
- All programmes can be named.
- Programme swapping between last watched two programmes.
- Forward or backward automatic tuning.
- Sleep timer.
- Automatic sound mute when no transmission.
- **Fill all, zoom, letterbox, subtitles, normal, 14:9, cinema and auto**, Auto switch WSS (Wide Screen Signaling).
- NTSC Playback.
- Front SVHS is available.
- Front AV in is available.
- It has VGA and DVI connector for external devices such as computer.
- AVL (Automatic Volume Limiting)
- Child Lock.
- When no valid signal is detected, after 5 minutes the TV switches itself automatically to stand-by mode.
- PLL (Channel Search)
- PC input (Support Up to WXGA 1366 x 768)
- Headphone output.
- Stereo PC Audio Input
- Plug&Play for Windows 9X, ME, 2000, XP
- 4H Comb Filter

- Audio Line Out
- "HD Ready"

Panel Features

- High resolution, 32-inch TFT LCD display.
- WXGA resolution (1366 x 768)
- Contrast ratio (800:1 typical)
- Brightness (typical) 500 cd/m²
- Response time (typical) 21 msec.
- Viewing angle (typical) 170° (horizontal) and 170° (vertical).
- Display colour 16.7 Million.

Safety Precautions

1. Power Source

The receiver should be operated only from a **230-240V AC, 50 Hz.** outlet. Ensure you select the correct voltage setting for your convenience.

2. Power Cord

The power supply cord should be placed so that it is not likely to be walked on or pinched by items placed upon them or against it. Pay particular attention to cord where it enters the plug, power outlet, and the point where it exits from the receiver.

3. Moisture and Water

Do not use this equipment in a humid and damp place (avoid the bathroom, the sink in the kitchen, and near the washing machine). Do not expose this equipment to rain or water, as this may be dangerous and do not place objects filled with liquids on top. Avoid from dripping or splashing.

4. Cleaning

Before cleaning, unplug the receiver from the main supply, outlet. Do not use liquid or aerosol cleaners. Use soft and dry cloth.

5. Ventilation

The slots and openings on the receiver are intended for ventilation and to ensure reliable operation. To prevent overheating,

these openings must not be blocked or covered in anyway.

6. Lightning

In case of storm and lightning or when going on holiday, disconnect the power cord from the wall outlet.

7. Replacement Part

When replacement parts are required, be sure the service technician has used replacement parts which are specified by the manufacturer or have the same specifications as the original one. Unauthorised substitutions may result in fire, electrical shock, or other hazards.

8. Servicing

Please refer all servicing to qualified personnel. Do not remove cover as this may result in electric shock.

9. Naked Flame Sources

Do not place naked flame sources on the apparatus.

WARNING: When the device is not in use for a long time, disconnect from power.

Instructions for waste disposal:

- Packaging and packaging aids are recyclable and should principally be recycled. Packaging materials, such as foil bag, must be kept away from children.
- Battery, including those which is heavy metal-free, should not be disposed of with household waste. Please dispose of used battery in an environmentally sound manner. Find out about the legal regulations which apply in your area.
- Cold cathode fluorescent lamp in LCD PANEL contains a small amount of mercury, please follow local ordinances or regulations for disposal.

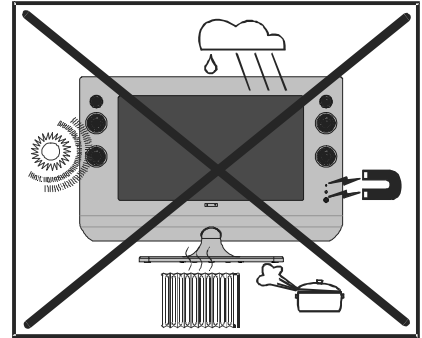
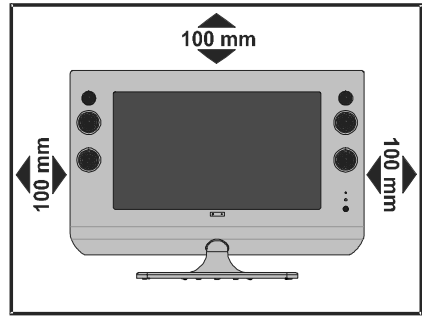

"The LCD panel is very high technology product with about a million thin film transistors, giving you fine picture details. Occasionally, a few non-active pixels may appear on the screen as a fixed point of blue, green or red. Please note that this does not affect the performance of your product."

"DO NOT LEAVE YOUR TV AT STAND-BY OR OPERATING WHEN YOU LEAVE YOUR HOUSE"

Preparation

For ventilation, leave a space of at least 10 cm free all around the set. To prevent any fault and unsafe situations, please do not place any objects on top of the set.

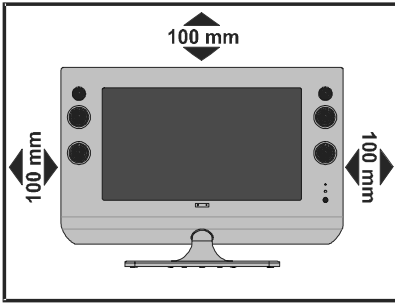

Use this apparatus in moderate climate.

Before Switching On Your TV

Power Connection

IMPORTANT: The TV set is designed to operate on 230-240V AC, 50 Hz.

- After unpacking, allow the TV set to reach the ambient room temperature before you connect the set to the mains.

Connections To The RF Input Socket

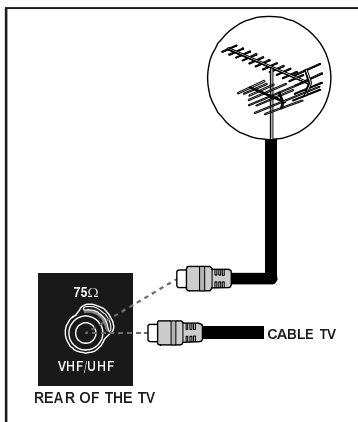

- Connect the aerial or cable TV plug to the RF input socket located at the back of the TV and connect the cable plug coming out from the TV out socket located at the devices (VCR, DVB etc.) to this socket as well.

How To Connect Other Devices

IMPORTANT: Switch off the TV before connecting any external device.

Sockets for external connections are at the back and side of the TV (optional). For connection of other devices via Euroconnector refer to the manuals of the related devices.

Inserting Batteries In The Remote Control Handset

- Place the batteries in the right directions as seen below.
- Remove the battery cover located on the back of the handset by gently pulling upwards from the indicated part.
- Insert two **MN2400 AAA** or equivalent type batteries inside.
- Replace the battery cover.

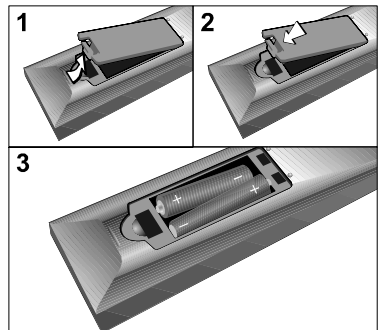

NOTE: Remove batteries from remote control handset when it is not to be used for a long period. Otherwise it can be damaged due to any leakage of batteries.

Switching The TV ON/OFF

To switch the TV on

Your TV will switch on in two steps:

1- Connect the power supply cord to the system. Press On/Off switch at the rear of the TV. Then the TV switches itself to stand-by mode and the LED becomes RED located on the right side of the TV. The LED located between TV and foot assembly is off.

2- To switch on the TV from stand-by mode either:

Press a digit button on the remote control so that a programme number is selected,

or,

Press "⏻", "-P/CH" or "P/CH+" button on the right side of the TV or press "-P/CH" or "P/CH+" button on the remote control, so that last switched off programme is selected.

By either ways the TV will switch on and the LED located on the right side of the TV will turn off. The LED located between TV and foot assembly becomes BLUE.

To switch the TV off:

- Press the "stand-by" button on the remote control, so the TV will switch to stand-by mode and the LED on the right side of the TV will become RED. The LED located between TV and foot assembly is off.

or,

Press the "⏻" button located on the right side of the TV, so the TV will switch off and the LED on the right side of the TV will become RED. The LED located between TV and foot assembly is off.

To power down the TV completely, press On/Off switch,

or

unplug the power cord from the mains socket.

Initial Settings

When the TV is turned on for the first time, IDTV is on first.

Because this is the first time that IDTV has been used, there are no channels stored in the memory and the following message appears on the screen.



- To start installation process, select "Yes", to cancel select "No".

- To select an option "Yes or No", highlight the item by using ◀ or ▶ buttons and press "OK" button.

The IDTV will automatically tune to the UHF transmission channels 21 to 68 looking for digital terrestrial TV broadcasts and displaying the names of channels found. This process will take about five minutes. To cancel searching, you can press "MENU" button at any time during the process.

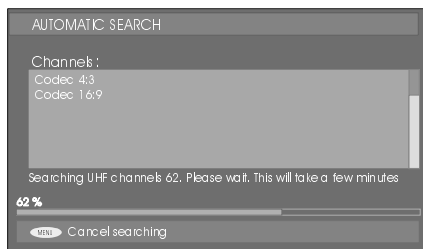

After **Automatic Search** process is completed, the following message asking for analogue channel search appears on the screen.

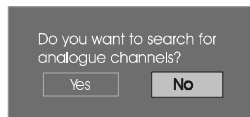

To search for analogue channels, select "Yes" option. TV switches to the analogue TV mode. The menu below is displayed to search for analogue channels.

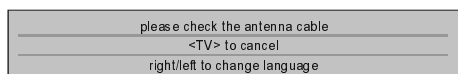
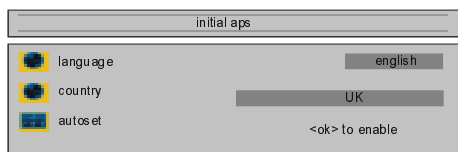

In initial_aps menu:

- By pressing ▲ or ▼ buttons, highlight the “**language**” item and select the language in which the menus of the TV will appear. You can see the available languages by pressing ◀ or ▶ buttons. As soon as you change the language, the menu items will be displayed in the selected language.
- By pressing the ▲ or ▼ buttons highlight the “**country**” item and select your country by pressing ◀ or ▶ buttons. This will affect the sort process in **initial_aps**.
- To close **initial_aps** menu, press “**TV**”/DTV button.

During **initial_aps** the message below appears on the screen.

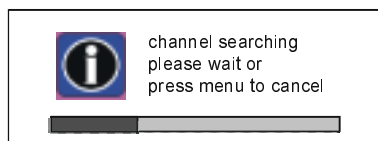

To cancel initial_aps, press “MENU” button.

After **initial_aps** is finalized, a programme list will appear on the screen. In the programme list you will see the programme numbers and names assigned to the programmes.

program table		
01 CNN	11	21
02 RAI2	12	22
03 SAT	13	23
04 RAI3	14	24
05 TV5	15	25
06 ZDF	16	26
07 RA1	17	27
08 C02	18	28
09 S07	19	29
10 C05	20	30
<input type="radio"/> Delete	<input type="radio"/> Insert	<input type="radio"/> Name

If you do not accept the locations and / or the programme names of programmes, you can change them in Programming menu. For details see Programming menu on page 25.

To display channel list in IDTV, switch to the IDTV via pressing **TV**/DTV button. Then press “MENU” button to enter main menu, **Channel List** will be highlighted press “SELECT” button to enter the menu. For detailed information see page 13.

Basic Operations

You can operate your TV using both the remote control and onset buttons.

Operation with the buttons on the TV

Volume Setting

- Press “- ▲” button to decrease volume or “▲ +” button to increase volume, so a volume level scale (slider) will be displayed at the middle of the bottom on the screen.

Programme Selection

- Press “P/CH +” button to select the next programme or “- P/CH” button to select the previous programme.

Entering Main Menu

- Press “MENU” button to enter Main menu. In the Main menu select sub-menu using “- P/CH” or “P/CH +” buttons and enter the sub-menu using “- ▲” or “▲ +” buttons. To learn the usage of the menus, refer to the Menu System sections.

Operation with Remote Control

The remote control of your TV is designed to control all the functions of the model you selected. The functions will be described in accordance with the menu system of your TV.

Functions of the menu system are described in the following sections.

Volume Setting

Press “▲ +” button to increase volume. Press “- ▼” button to decrease volume. A volume level scale (slider) will be displayed in the middle at the bottom of the screen.

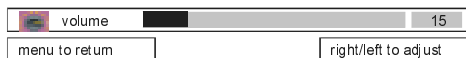

Programme Selection (Previous or next programme)

- Press “- P/CH” button to select the previous programme.
- Press “P/CH +” button to select the next programme.

Programme Selection (direct access):

Press digit buttons on the remote control to select programmes between 0 and 9. TV will switch to the selected programme. To select programmes between 10 - 999 for IDTV and 0-99 for analogue TV, press the digit buttons consecutively which programme you want to select (eg. for programme 27, first press 2 and then 7). When it is late to press second digit button only the first digit programme will be displayed. The limit of the delay time is 3 seconds.

Press directly the programme number to reselect single digit programmes.

Hint: The channel list numbers are assigned by the broadcasters. Because not all channels are broadcast free-to-air and stored by the receiver, the channel list numbers do not run continuously. The fifteenth channel in the list, for example, may not be channel number 15 but channel number 17.

Hint: If you enter a number which does not correspond to a stored channel, the next valid channel number is selected instead. If you enter a number greater than the highest numbered channel in the channel list, the IDTV will select the last channel in the list.

Everyday Operation

Pressing the “TV/DTV” button at any time while watching television programmes will switch the TV set between the digital terrestrial television broadcasting and the analogue broadcasting.

Information Banner

- Whenever you change channel, using the P/CH + or - P/CH buttons or the number buttons, TV displays the channel picture along with an information banner at the bottom of the screen. This will remain on the screen for approximately three seconds.
- The information banner can also be displayed at any time while watching TV by pressing the “INFO” button on the remote control and disappears after a while.



The information banner gives a number of facts on the channel selected and the programmes on it.

- The name of the channel is displayed, along with its channel list number and an indication of the strength of the signal received on this tuning channel.
- The current and next programme information is given with the start and finish time.
- The current time information is displayed along with the channel name.

Hint

Not all channels broadcast the programme data. If the name and times of the programme is not available then “No Information Available” is displayed in the information banner.

Icons are also displayed in the information banner.

If the channel is set as favourite channel,

😊 is displayed next to the channel.

If the selected channel is locked, you must enter the correct four digit code to view the channel.



ELECTRONIC PROGRAMME GUIDE (EPG)

Some, but not all, channels send information about the current and next events. Please note that event information is updated automatically. If there is no event information data available in channels, only channel names with **“No Information Available”** banner is displayed.

- Press **“GUIDE”** button to view the EPG menu.
- In EPG Menu, you can easily see the extended help information by pressing **“INFO”** button and by pressing this button again you can close this window.

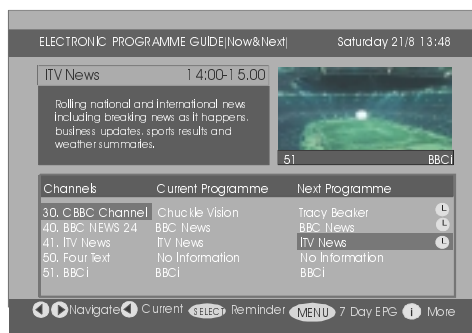

• In the EPG Menu all channels are displayed. Current channel is highlighted when you enter the EPG menu.

- Use **▲** or **▼** buttons to change channels.

Also press **▲** or **▼** buttons to make page up/down scroll for the channels. And press **“SELECT”** button to watch the highlighted channel.

• If you highlight an event, short event description, extended event description, start and finish times of event are displayed on the screen.

• When the current programme is highlighted, the box is switched to the highlighted channel by pressing **“SELECT”** button.

• If you press **“SELECT”** button when a next event is highlighted, a reminder is set for the highlighted programme and a clock appears across the highlighted channel line.

Programme reminders can be set to signal that a programme is about to start when you are watching another channel. If you set reminder to a programme, then you will be asked for switching to that channel when the reminder time is reached.

- Press **“MENU”** to view the 7 day EPG.
- Press **▲** or **▼** buttons to navigate in Channels or Programmes.
- Press **◀** or **▶** buttons to navigate through the channel and programme list.



• With **“RED/GREEN”** buttons you can change schedule time. By pressing **“YELLOW/BLUE”** you can advance the schedule backward / forward of a day.

• If you press **“INFO”** button you can see the detailed help information easily. And by pressing **“INFO”** button again you can exit Help menu.

• The starting time for **EPG** is the current time. You can see the event information for the next two hours. By pressing **▲** or **▼** buttons, you can go to the next/previous hours while Programmes list is highlighted,.

• If you press **“SELECT”** button when a next event is highlighted, a reminder is set for the highlighted programme and a clock appears on the screen.

Programme reminders can be set to signal that a programme is about to start when you are watching another channel. If you set reminder to a programme, then you will be asked for switching to that channel when the reminder time is reached.



Displaying The Subtitles

With Digital terrestrial broadcasting (DVB-T), some programmes are broadcast with subtitles. Subtitles can be displayed when watching these programmes.

Press “MENU” button to display the Main menu, highlight the **Configuration** line using ▲ or ▼ buttons and press “SELECT” button to display the Configuration menu.

Highlight the “**Subtitle**” item in Configuration menu and use ◀ or ▶ buttons to set Subtitle to off or a language.

If “**Subtitle**” is on via selecting one language option, pressing  button causes the following warning message display on the screen.



DIGITAL TELETEXT

With Digital terrestrial broadcasting (DVB-T), in addition to pictures and sound, you can also watch digital teletext.

Digital teletext is sometimes broadcast at the same time as normal broadcasting.

1. Press the button.

The digital teletext information appears.

2. Operate it with the colour buttons, ◀/▶/▼/▲ buttons and OK button.

The operation method may differ depending on the contents of the digital teletext.

Follow the instructions displayed on digital teletext screen.

- When “Press SELECT” button or similar message appears on the screen, press the “SELECT” button.

- When the  (Text) button is pressed, the TV returns to television broadcasting.

- With Digital terrestrial broadcasting (DVB-T), in addition to digital teletext broadcasting at the same time as normal broadcasting, there are also channels with just digital teletext broadcasting.

- The aspect ratio when watching a channel with just digital teletext broadcasting is the same as the aspect ratio of the picture watched previously.

- When you press the  (Text) button again, the digital teletext screen is displayed.

Over Air Download

Over Air Download (OAD): To ensure that your IDTV always has the most up-to-date information. Please ensure that after use it is set to its standby mode. At 3AM each day, the IDTV automatically searches for any new information which may be broadcast and will download this to your IDTV automatically. This operation will normally take approximately 30 seconds.

If you want to do this, you need to set Automatic Download to “**Enabled**” in Receiver Upgrade setting. For details see page 17.

Widescreen

Depending on the type of broadcast being transmitted, programmes can be viewed in a number of formats. Press the “WIDE” button and use ◀ or ▶ buttons repeatedly to select between **fill all (16:9)**, **zoom**, **letterbox**, **subtitles**, **normal**, **14:9**, **cinema** or **auto**.

When **Auto** is selected, the format being displayed is determined by the picture being broadcast.

Please Note: Menu size changes depending on the chosen image size.

IDTV Menu System

The IDTV menu can only be shown when watching Digital terrestrial broadcasting.

Press **IDTV** button to turn IDTV on while TV is in analogue mode.

1. Press MENU button.

The menu below appears on the screen:

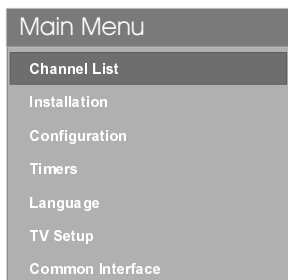

Channel List

Using **▲** or **▼** buttons on the remote control in Main menu, make sure that the first item, Channel List, is highlighted and press the “SELECT” button to display the **Channel List**.

The following operations can be performed in this menu:

1. Navigating the whole list of channels
2. Deleting channels
3. Renaming channels
4. Adding locks to channels
5. Setting favourites

Channel List is the place where the channels are managed.

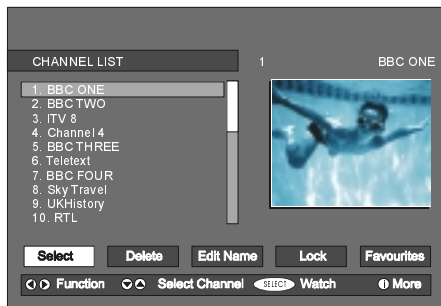

Navigating the whole channel list

- Press **▲** or **▼** keys for selecting the previous or next channel.
- You can press **▲** or **▼** buttons to move page up or page down.

To watch a specific channel, highlight it using **▲** or **▼** buttons and then press “SELECT” button, while the “Select” item on Channel List menu is highlighted by using **◀** or **▶** buttons.

Then the name and number of the selected channel will be displayed in the top-left and top-right of the channel display at the top-right of the screen, respectively.

Deleting the channels in the channel list

Press **▲** or **▼** buttons to select the channel that will be deleted.

Press **◀** or **▶** buttons to select the “Delete” item on Channel List menu.

As seen on Channel List menu, “Select” is written next to “Delete” item at the bottom of the screen to indicate that press “SELECT” button to delete the highlighted channel in the channel list.

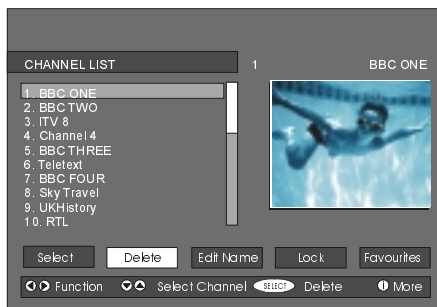

Press “SELECT” button to delete the highlighted channel in the channel list. Then the message below appears on the screen.

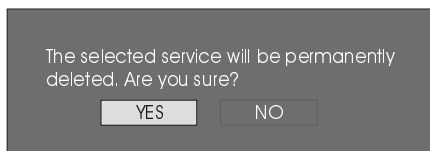

Press **◀** or **▶** buttons to highlight the de-

sired option. If “SELECT” button is pressed while “Yes” is highlighted, the highlighted channel is deleted. Selecting “NO” cancels the delete operation.

Renaming channels

To rename a specific channel, the channel must be highlighted via pressing ▲ or ▼ buttons and then highlight the “Edit Name” item by pressing ◀ or ▶ buttons. Press “SELECT” button to activate rename feature.



Now pressing ◀ or ▶ buttons moves to the previous/next character. Pressing ▲ or ▼ buttons toggles the current character, i.e., ‘b’ character becomes ‘a’ on ▼ and ‘c’ on ▲. Pressing the numeric buttons ‘0...9’ replaces the highlighted character with the characters printed above the key one by one as the button is pressed.

Press the “MENU” button to cancel the editing and “SELECT” button to save the new name.

Adding locks to channels

Channel Locking provides a password-protected access to channels selected by parents.

In order to lock a channel you should know the Parental Lock password (default value is set to 0000 in the factory and can only be changed from the **Configuration Menu**).

By pressing ▲ or ▼ buttons, highlight the channel to be locked and select the “Lock” option by pressing ◀ or ▶ buttons. Then press the “SELECT” button, a password box

is displayed. Enter the lock key (0000 default value). To unlock the locked channel press “SELECT” button while the locked channel is highlighted.

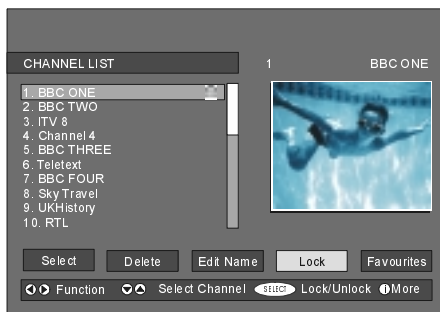

Setting Favourites

You can set various channels as favourites so that only the favourite channels are navigated. To set a favourite you should highlight the “Favourites” item at bottom of the Channel List menu.

Use ◀ or ▶ buttons to highlight the “Favourites” item at the base of the screen and then, in turn, highlight each channel you want to add to the favourites list, using the ▲ or ▼ buttons (or ▲ / ▼ buttons), and press “SELECT” button.

A channel selected as a favourite appears in the main channel list with a favourites icon “☺” against the channel name.

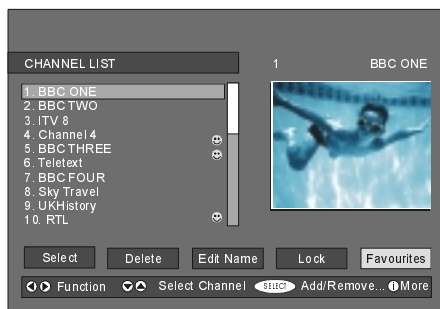

On Screen Help Pressing INFO Button

For all menus press “INFO” button to display the help information about the menu functions. For **Channel List** menu the following message is displayed on the screen.

Press the SELECT button on your remote control to tune to the highlighted channel.
Press MENU to exit this screen.

Hint:

Entering More item pressing “INFO” button gets quick and easy use of the all menus in IDTV displaying information for the highlighted menu item.

Installation

The Installation menu mainly intends to help you for building a **Channel Table** in most efficient way.

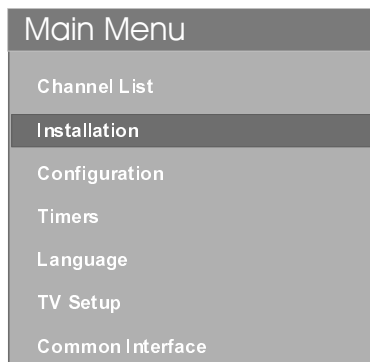

This menu includes the following items:

1. Add New Channels
2. First Time Installation.



ADD NEW CHANNELS:

This tuning menu consists of two parts:

- Automatic Search
- Manual Search

Automatic Search:

Automatic search is started by pressing “SELECT” button in the auto-search pop up menu. All the services are searched and a channel table is created automatically.

All channels found are stored in a sorted form with respect to their channel numbers. Some services may not appear with the correct channel number. At the time of printing, not all broadcasters are sending their channel number information.

Manual Search:

In manual search, the number of the multiplex is entered manually and only that multiplex is searched for the channels. For every valid channel number, signal level, signal quality and network name are shown at the bottom of the screen.

In both manual and auto search any existing channel in the database is not re-stored to avoid redundant duplicates of that channel.

FIRST TIME INSTALLATION

The user can use this item to load default settings, which had been loaded to the receiver at the factory.

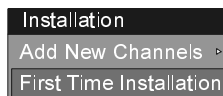

To install factory settings, highlight “**First Time Installation**” menu and press “SELECT” button, then you will be asked to confirm for deleting all channels and settings.

Highlight “**Yes**” by using ◀ or ▶ buttons and press “SELECT” button. Then the existing channel table will be deleted.

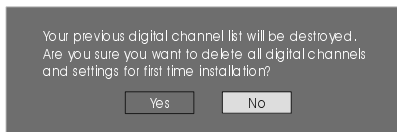

After factory settings is loaded, “**First Time Installation**” menu will be displayed.

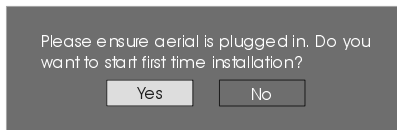

Press “SELECT” button while “**Yes**” is highlighted to start installation. After search is completed for digital channels, a message asking search for analogue channels appears on the screen.

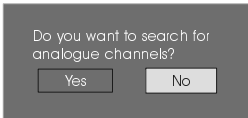

Highlight **“Yes”** and press **“SELECT”** button to search for analogue channels. The following menu appears on the screen for analogue channel search.

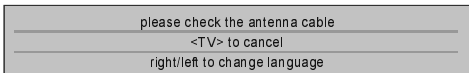
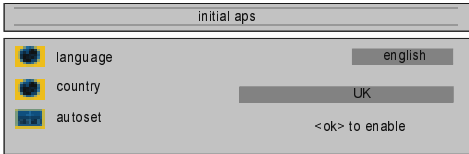

By pressing **▲** or **▼** buttons, highlight the item you want to adjust. And by pressing **◀** or **▶** buttons adjust **“language”** and **“country”** items.

Press **“OK”** button to start the autotest operation while **“autotest”** item is highlighted.



After APS is finalized, the programme table will appear on the screen. In the programme table you will see the programme numbers and names assigned to the programmes.

If you do not accept the locations and / or the programme names, you can change them in aps submenu in the settings menu. (See page 27 for Program table explanation.)

Configuration

Press **“MENU”** button to display the Main Menu and the **▼** button twice to highlight **Configuration**, then press **“SELECT”** button to display the Configuration menu. Press **“MENU”** button to exit the menu.

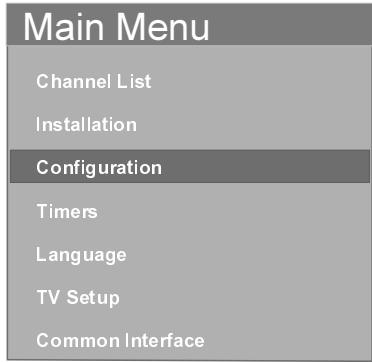

The various configuration functions are displayed in a list, along with a quarter-screen image of the currently selected channel. You can select a function by highlighting the corresponding menu line using the **▲** or **▼** buttons.

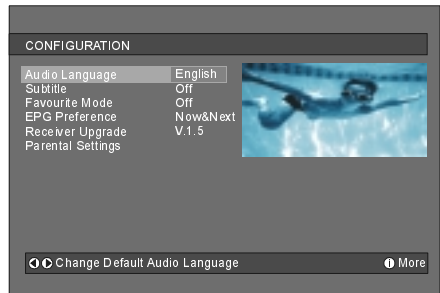

Audio Language

Digital terrestrial television channels can broadcast simultaneous soundtracks in more than one language. This function selects which language soundtrack you will hear when switching to a channel broadcasting with the multiple soundtracks.

Highlight the **Audio Language** line in the configuration menu and use **◀** or **▶** buttons to cycle through the language options.

Subtitle

Digital terrestrial television channels can broadcast with subtitles displayed on-screen for the hard-of-hearing. This function selects the desired subtitle language and enables the automatic display of subtitles whenever subtitle information is broadcast.

Highlight the **Subtitle** line in the Configuration menu and use ◀ or ▶ buttons to cycle through “Off” and language options.

Return NO MENU to normal TV viewing by pressing the “MENU” button.

Favourite Mode

This function enables or disables the favourite channel list mode. See Channel List menu Favourites on page 14.

Use ◀ or ▶ buttons to turn favourite mode on/off. If the “Favourite Mode” is on, in normal operating mode pressing “P/CH+” and “-P/CH” buttons will only navigate through the channels that were previously defined as favourites in Channel List.

If there is no favourite channel in the Channel List menu, the following warning message appears on the screen during Favourite Mode adjustment.



EPG Preference

Digital terrestrial television channels can broadcast simultaneous Next&Now and 7-Day electronic programme.

Highlight the EPG Preference line in the Configuration menu and use the ◀ or ▶ buttons to select **Next&Now** or **7-Day**.

Receiver Upgrade

The IDTV can be upgraded via the configuration menu, entered from the main menu.

In the configuration menu, highlight the “**Receiver Upgrade**” item by pressing ▲ or ▼ buttons and press “SELECT” button to start upgrade process.

There are two possibilities for Receiver software to be upgraded: **automatic** and **manual**.

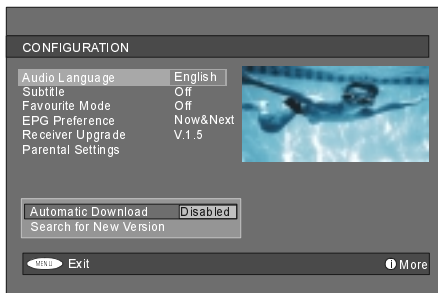

Automatic Download (Automatic upgrade)

Automatic Download can be enabled or disabled by pressing ◀ or ▶ buttons. If it is enabled, then there are two ways for automatic upgrade.

The first one is checking the existence of a new software every time the IDTV goes to standby. The second one is waking up at 03:00 a.m. every night, provided that the IDTV is left in standby mode. Both automatic upgrade methods result in standby mode either upgraded or not.

If the automatic upgrade is set to 'Disabled' then this function will not work.

Search For New Version (Manual upgrade)

Manual upgrade starts if the “**Search for New Version**” item is highlighted by using ▲ or ▼ buttons and activated via pressing “SELECT” button.

After “**Search for New Version**” is activated, the IDTV tunes to each frequency that have been stored in its database and looks for the new software.



Parental Settings

Some channels broadcast material which you do not want younger members of the family to watch. Any channel can be 'locked' so that it cannot be selected for viewing without first a four-digit PIN code being entered. In this way any channel not suitable for younger viewers can be protected.

This function enables or disables the menu protection system and allows the PIN code to be changed. Channel And Menu Protection Lock feature.

Use ▲ or ▼ buttons to go to Parental Settings option. Press “SELECT” button to enter Parental Settings Menu. A box asking for the lock key is displayed.

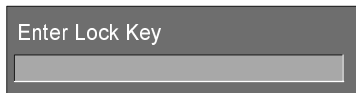

There is only one key which is set to “0000” initially. Enter lock key. If wrong Lock key is entered, the following message is displayed on the screen and it is returned back.



If it is correct, the Parental Settings Menu including following items is displayed:

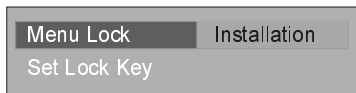

There you can set/reset locking for the Main Menu, or the Installation Menu to restrict access. If the menu lock is disabled, there will be free access to the menu system. Also in this menu you can change the lock key and set/change parental lock mode.

Disabled: All menus are unlocked.

Main Menu: Main menu is accessible only with the correct lock key. So the user cannot add, delete, rename, move channels, cannot set timers.

Installation: Installation menu is locked, so the user cannot add channels.

Changes will be updated after exiting Configuration Menu.

Timers

Display the Main Menu by pressing the “MENU” button. Highlight the **Timers** line by pressing ▲ or ▼ buttons and press “SELECT” button to display the Timer menu.

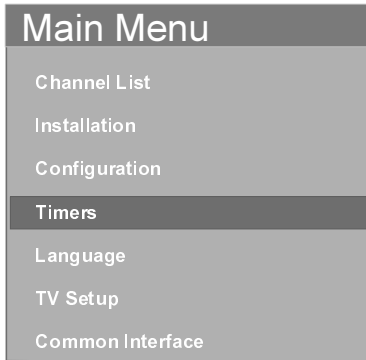

Up to five separate timer events can be set and each is displayed in the Timer screen, showing the event number, the channel to be selected, the start time, end time, date and the mode - whether that event is active (and will be acted on) or not.

TIMER MENU					
No	Channel Name	Start	End	Date	Mode
1.	ITV 1	20:00	21:00	12/05/2005	Active
2.	BBC ONE	00:00	00:00	01/01/2005	Inactive
3.	BBC ONE	00:00	00:00	01/01/2005	Inactive
4.	BBC ONE	00:00	00:00	01/01/2005	Inactive
5.	BBC ONE	00:00	00:00	01/01/2005	Inactive

⏪ Toggle Mode ⏩ Exit ⏪ Edit Timer ⏩ More

- To set an event, highlight its mode button using ▲ or ▼ buttons and press “SELECT” button to display the timer entry window.

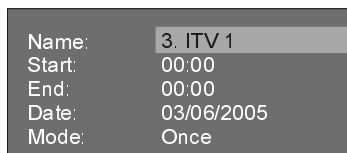

- Here the five settings of channel name, start time, end time, date and frequency mode can be set. You can move freely between each setting using ▲ or ▼ buttons.

- The channel name is set using ◀ or ▶ button to display the channel which broadcasts the programme.

- The start time, end time and date are each

set with the number keys on the remote control in 24-hour format.

- The frequency mode determines how often the receiver operates this event and is set with ◀ or ▶ buttons to be either **Once**, **Daily**, or **Weekly**.

Hint

If an invalid number for the start or end times or the date are entered, one of the following messages appear on the screen depending on the mistake during the time or date entry.

*"End time cannot be the same as start time",
"Please choose a date and time in the future" or
"Entered time is not valid".*

Language

Some programmes are broadcast in two or more languages simultaneously. The language heard can be selected from the Language Menu.

- Press "MENU" button to display the Main Menu and use the ▲ or ▼ buttons to highlight the Language line and press "SELECT" button.

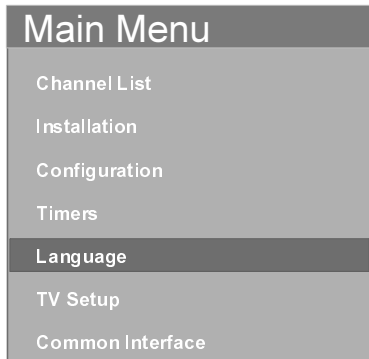

- Use the ▲ or ▼ buttons to highlight the soundtrack language required and press "SELECT" button. Normal viewing, with the required language soundtrack, can be resumed by pressing the "MENU" button.

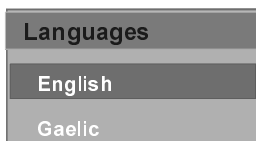

- If the programme has no alternative lan-

guage soundtrack broadcast, the Language Menu will not be available, but a message, "**No Multi Language Available**" is displayed briefly.

TV Setup

To be able to go through TV functions, you can use this item.

The digital TV Setup menu screen is accessed from the main menu. Press the "MENU" button to display the main menu and use ▲ or ▼ buttons to highlight "TV Setup", press "SELECT" button to display TV Setup menu screen.

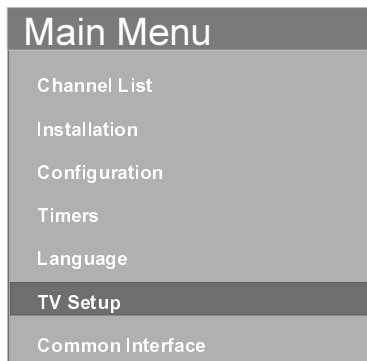

Detailed information for all menu items is in Analogue TV Menu System section on page 21.

Picture Menu

By pressing ◀ or ▶ buttons, select the first icon. Picture menu appears on the screen.

Brightness, contrast, sharpness and color settings can be adjusted in IDTV mode.

Use ▲ or ▼ buttons to highlight brightness, contrast, sharpness or color and use ◀ or ▶ buttons to adjust the settings.

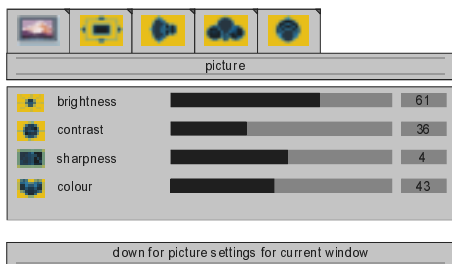

Window Menu

By pressing ◀ or ▶ buttons, select the second icon. window menu appears on the screen.

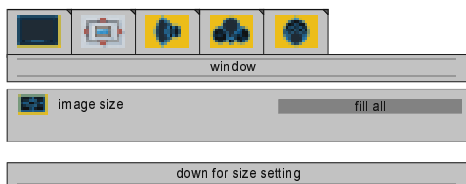

Use the ▲ or ▼ buttons to highlight the menu item you want to adjust, and use ◀ or ▶ buttons to adjust the settings.

Audio Menu

By pressing ◀ or ▶ buttons, select the third icon. Audio menu appears on the screen.

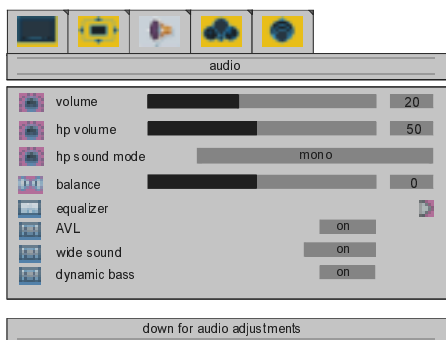

Use the ▲ or ▼ buttons to highlight the menu item you want to adjust, and use ◀ or ▶ buttons to adjust the settings.

Options Menu

By pressing ◀ or ▶ buttons, select the fourth icon. Options menu appears on the screen.

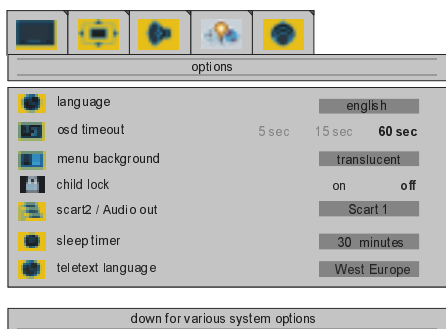

Use ▲ or ▼ buttons to highlight the menu item you want to adjust, and use ◀ or ▶ buttons to adjust the settings.

Settings Menu

By pressing ◀ or ▶ buttons, select the fifth icon. Settings menu appears on the screen.

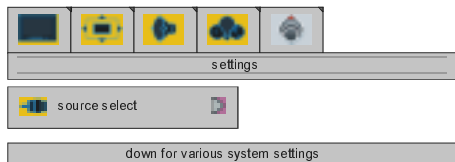

Use ▼ button to highlight the “source select” item. And use ◀ / ▶ or “OK” buttons to view the sources.

Use ▲ or ▼ buttons to highlight the source, and press ▶ button to select.

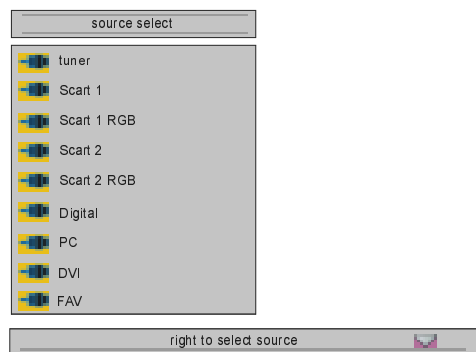

Common Interface

- Press “MENU” button to display the Main Menu and use ▲ or ▼ buttons to highlight the “Common Interface” line and press “SELECT” button.

Main Menu

Channel List
Installation
Configuration
Timers
Language
TV Setup
Common Interface

It is required to subscribe to a pay channel company to view the pay channels of the Digital Terrestrial broadcasting.

Obtain the Conditional Access Module (CAM) and the Viewing card by subscribing to a pay channel company, then insert those to the Television using the following procedure.

1. Switch off the TV and unplug from the mains.

2. Insert the CAM, then Viewing Card to the slot that is located in the terminal cover at the left-hand side of the TV (from front view).

- The CAM should be correctly inserted, it is impossible to insert fully if reversed. The CAM or the TV terminal may be damaged if the CAM is forcefully inserted.

3. Connect the TV to the mains supply, switch on and then wait for few moments until the card is activated.

- Some CAMs may require the following set up. Please set the CAM by entering the IDTV menu, Common Interface then pressing "SELECT" button. (CAM set up menu is not displayed when it is not required.)

- To see the viewing contract information:

Enter IDTV; press "MENU" button, then highlight **Common Interface** and press "SELECT" button.

- When no module is inserted, "**No Common Interface module detected**" message appears on the screen.

- Refer to the module instruction manual for details of the settings.

Analogue TV Menu System

Your TV has been designed with a menu system to provide an easy manipulation of a multifunction system. Press the "**M**" (**MENU**) button to enter the menu. "**M**" button has two functions. The first function of it is opening and closing the menu, the second function is closing the submenu and then opening its parent menu.

Press ◀ / ▶ button to select a menu title and then ▲ / ▼ button to select a menu item and ◀ / ▶ or "OK" button to enter the menu item. To exit a menu press "**M**" button.

Picture Menu

By pressing ◀ / ▶ button, select the first icon. Picture menu appears on the screen.

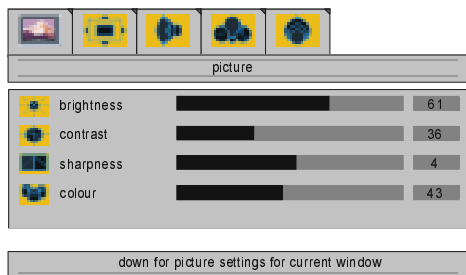

brightness

By pressing ▲ / ▼ button, select **brightness**. "**right/left to adjust brightness**" is seen on the screen. Press ▶ button to increase brightness. Press ◀ button to decrease brightness. Brightness level can be adjusted between 0 and 100.

contrast

By pressing ▲ / ▼ button, select **contrast**. "**right/left to adjust contrast**" is seen on the screen. Press ▶ button to increase contrast. Press ◀ button to decrease contrast. Contrast level can be adjusted between 0 and 100.

sharpness

By pressing ▲ / ▼ button, select **sharpness**. "**right/left to change sharpness**" is seen on the screen. Press ▶ button to increase sharpness. Press ◀ button to de-

crease sharpness. Sharpness level can be adjusted between 0 and 8.

colour

By pressing ▲ / ▼ button, select **colour**. "right/left to adjust colour" is seen on the screen. Press ► button to increase colour. Press ◀ button to decrease colour. Colour level can be adjusted between 0 and 100.

tint

This item is displayed in picture menu when TV is in AV mode and at NTSC signal. By pressing ▲ / ▼ button, select **tint**. "right/left to adjust tint" is seen on the screen. Press ► button to increase tint. Press ◀ button to decrease tint. Tint level can be adjusted between 0 and 100.



down for picture settings for current window

When TV is in AV mode; picture menu items (brightness, contrast, sharpness and colour) may require re-adjustment.

When VGA Or DVI Is Connected To TV:

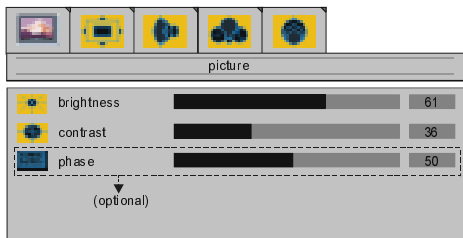

down for picture settings for current window

brightness

By pressing ▲ / ▼ button, select **brightness**. "right/left to adjust brightness" is seen on the screen. Press ► button to in-

crease brightness. Press ◀ button to decrease brightness. Brightness level can be adjusted between 0 and 100.

contrast

By pressing ▲ / ▼ button, select **contrast**. "right/left to adjust contrast" is seen on the screen. Press ► button to increase contrast. Press ◀ button to decrease contrast. Contrast level can be adjusted between 0 and 100.

phase (optional)

This item is not available in the picture menu when DVI is connected to the TV.

By pressing ▲ / ▼ button, select **phase**. "right/left to adjust phase" is seen on the screen. Press ► button to increase phase. Press ◀ button to decrease phase. Phase level can be adjusted between 0 and 100.

Window Menu

By pressing ◀ / ► button, select the second icon. Window menu appears on the screen.

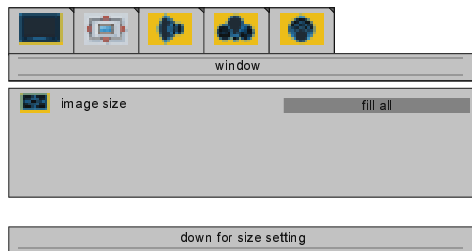

image size

By pressing ▲ / ▼ button, select **image size**. "right/left to change image size" is seen on the screen. By pressing ◀ / ► button, you can change image size to **fill all**, **zoom**, **letterbox**, **subtitles**, **normal**, **14:9**, **cinema** and **auto**.

You can enter image size directly by pressing "⏏" button. By pressing ◀ / ► button, you can change image size.

When VGA is Connected To TV:

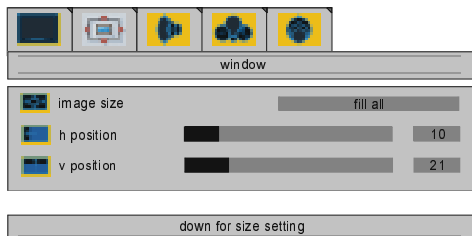

image size

By pressing ▲ / ▼ button, select **image size**. "right/left to change image size" is seen on the screen. By pressing ◀ / ▶ button, you can change image size to **fill all**, **fill 1:1** and **fill aspect**.

h position

By pressing ▲ / ▼ button, select **h position**. "right/left to adjust h position" is seen on the screen. Press ▶ button to slide the screen to the left. Press ◀ button to slide screen to the right. **h position** can be adjusted between 0 and 100.

v position

By pressing ▲ / ▼ button, select **v position**. "right/left to adjust v position" is seen on the screen. Press ▶ button to slide the screen up. Press ◀ button to slide the screen down. **v position** can be adjusted between 0 and 100.

When PC Connected To TV via DVI

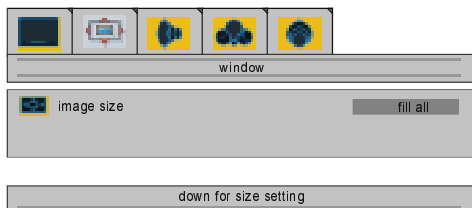

image size

By pressing "▲" / "▼" button, select **image size**. "right/left to change image size" is seen on the screen. By pressing "◀" / "▶" button, you can change image size to **fill all**, **fill 1:1** and **fill aspect**.

- Window menu is not available when split screen option is selected.

Audio Menu

By pressing ◀ / ▶ button, select the third icon. Audio menu appears on the screen.

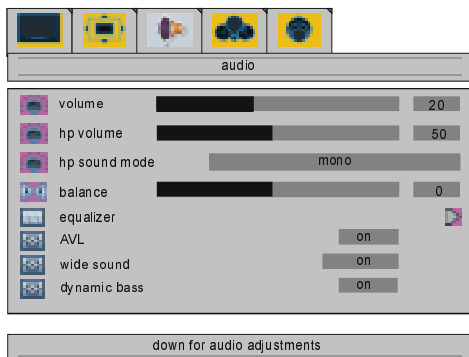

volume

By pressing ▲ / ▼ button, select **volume**. "right/left to adjust volume" is seen on the screen. Press ▶ button to increase volume level. Press ◀ button to decrease volume level. Volume level can be adjusted between 0 and 54.

hp volume

By pressing ▲ / ▼ button, select **hp volume**. "right/left to adjust hp volume" is seen on the screen. Press ▶ button to increase hp volume level. Press ◀ button to decrease hp volume level. Hp volume (headphone volume) level can be adjusted between 0 and 100.

hp sound mode

By pressing ▲ / ▼ button, select **hp sound mode**. "right to adjust hp sound mode" is seen on the screen. Press ▶ button change hp sound mode.

Hp sound mode is used to identify sound mode of the headphone. hp sound mode can be set to **mono**, **stereo**, **dual a** or **dual b** according to the transmission.

balance

By pressing ▲ / ▼ button, select **balance**. “right/left to adjust balance” is seen on the screen. Press ► button to increase balance rightward. Press ◀ button to decrease balance leftward. Balance level can be adjusted between -50 and 50.

equalizer

By pressing ▲ / ▼ button, select **equalizer**. “right/left for equalizer settings” is seen on the screen. Press ◀ / ► button or “OK” button to enter equalizer menu. In equalizer menu the sound mode can be changed to **user**, **flat**, **pop**, **rock**, **jazz** and **classic** by pressing ◀ / ► button. Equalizer menu settings can be changed only if **sound mode** is **user**. Select the desired frequency by ▲ / ▼ button and increase or decrease the frequency gain by pressing ◀ / ► button.

Press the “M” button to exit the equalizer menu.



AVL

AVL (Automatic Volume Limiting) function is used to get fixed sound output level for the programmes having different sound output levels.

By pressing ▲ / ▼ button, select **AVL**. “right/left for AVL on/off” is seen on the screen. By pressing ◀ / ► button set AVL to **on** to activate it or **off** to deactivate it.

wide sound

It is used to gain saloon effect to the sound.

By pressing ▲ / ▼ button, select **wide sound**. “right/left for wide sound off/stereo/mono” is seen on the screen. By pressing ◀ / ► button set wide sound to **mono/stereo** to activate it or **off** to deactivate it.

dynamic bass

Dynamic Bass is used to increase bass effect of the TV set.

By pressing ▲ / ▼ button, select **dynamic bass**. “right/left for dynamic bass on/off” is seen on the screen. By pressing ◀ / ► button set dynamic bass to **on** to activate it or **off** to deactivate it.

Options Menu

By pressing ◀ / ► button, select the fourth icon. Options menu appears on the screen.

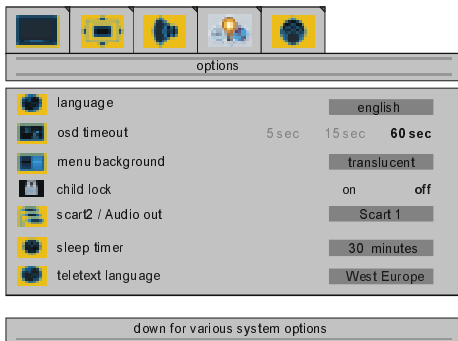

language

By pressing ▲ / ▼ button, select **language**. “right/left to change language” is seen on the screen. By pressing ◀ / ► button, you can select the language.

vcr

This item is displayed only when TV is in AV mode. By pressing ▲ / ▼ button, select **vcr**. “right/left to change vcr status” is seen on the screen. By pressing ◀ / ► button set vcr to **on** or **off**.

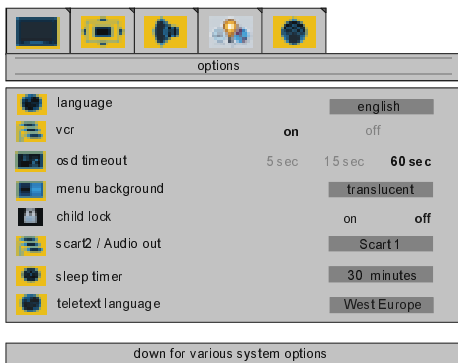

osd timeout

By pressing ▲ / ▼ button, select **osd timeout**. “**right/left to change osd timeout**” is seen on the screen. By pressing ◀ / ▶ button, you can change osd timeout to **5 sec, 15 sec** or **60 sec**.

menu background

By pressing ▲ / ▼ button, select **menu background**. “**right to change menu background**” is seen on the screen. You can change menu background to **translucent** or **opaque** by pressing ▶ button.

child lock

You can use this feature to prevent children from turning the TV on or changing programmes, adjustments etc. without remote control.

By pressing ▲ / ▼ button, select **child lock**. “**right/left to change**” is seen on the screen. The child lock feature can be set by ◀ / ▶ button to either **on** or **off**. When **off** is selected, there will be no difference in the operation of your TV. When **on** is selected, the TV can only be controlled by the remote control handset.

scart 2/audio out

By pressing “▲” / “▼” button, select **scart 2/audio out**. “**right/left to select scart 2/audio out**” is seen on the screen. You can set scart 2 out to **Scart 1, Tuner** or **Digital** by pressing “◀” / “▶” button.

scart 2/audio out operates parallel with Audio out. The selected source in scart 2/audio out can be taken from Audio line output at the rear of the TV.

sleep timer

By pressing ▲ / ▼ button, select **sleep timer**. “**adjust sleeptimer**” is seen on the screen. You can set the sleep time to **0, 10, 20, 30, 40, ..., 100, 110, 120 minutes** by pressing ◀ / ▶ button. The sleep timer is used to turn the TV off after a pre-defined period.

teletext language

By pressing ▲ / ▼ button, select teletext language. “**right/left to select teletext language**” is seen on the screen. You can set teletext language to **West Europe, East Europe, Greek-Turkey, Russian** or **Arabic** by pressing ◀ / ▶ button.

Settings Menu

By pressing ◀ / ▶ button, select the fifth icon. Settings menu appears on the screen.

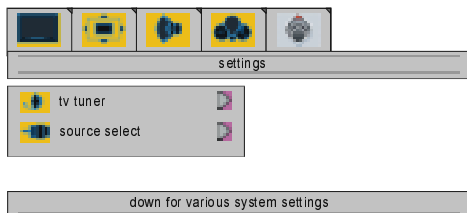

tv tuner

By pressing ▲ / ▼ button, select **tv tuner**. “**<ok> to activate tuner menu**” is seen on the screen. By pressing ◀ / ▶ or “OK” button enter the menu. **tv tuner** menu has two sub-menu named as **programming** and **aps**.

Programming Menu

By pressing ◀ / ▶ button in **tv tuner** menu, select the first icon. Programming menu appears on the screen.

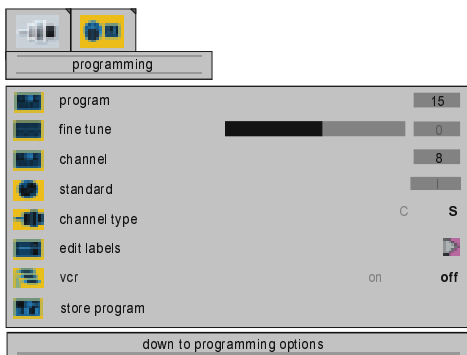

program

By pressing ▲ / ▼ button, select **program**. “**right/left to select program**” is seen on the screen. By pressing ◀ / ▶ button, you can

select the program number. You can also enter a number via digit buttons on the remote control. There are 100 program storage between 0 and 99.

fine tune

By pressing ▲ / ▼ button, select **fine tune**. "right/left to adjust fine tuning" is seen on the screen. By pressing ◀ / ▶ button, you can adjust the tuning. The adjust values are between -50 and +50.

channel

By pressing ▲ / ▼ button, select **channel**. "right/left to change channel" is seen on the screen. By pressing ◀ / ▶ button, you can change the channel number. You can also enter a number via digit buttons on the remote control. The adjust values change according to the **standard** and **channel type**.

standard

By pressing ▲ / ▼ button, select **standard**. "right/left to change standard" is seen on the screen. By pressing ◀ / ▶ button, you can change the standard to **B/G, D/K, I or L'**.

channel type

By pressing ▲ / ▼ button, select **channel type**. "right/left to change channel type" is seen on the screen. By pressing ◀ / ▶ button, you can change the channel type to **C or S**.

edit labels

By pressing ▲ / ▼ button, select **edit labels**. "right/left to edit labels" is seen on the screen. By pressing ◀ / ▶ or "OK" button, you can enter the following menu.



▲ / ▼ or ◀ / ▶ buttons are used to edit labels.

vcr

"vcr" can be selected for each channel in TV system.

By pressing ▲ / ▼ button, select **vcr**. "right/left to change vcr status" is seen on the screen. By pressing ◀ / ▶ button set vcr to **on or off**.

While **vcr** is set **on**, select **store program** to store.

store program

By pressing ▲ / ▼ button, select **store program**. "right/left to store program" is seen on the screen. By pressing ◀ / ▶ or "OK" button, you can store the program and following menu appears on the screen.

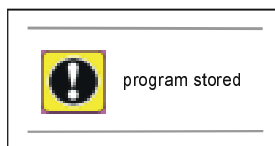

manual search

By pressing ▲ / ▼ button, select **manual search**. "right/left to search" is seen on the screen. By pressing ◀ / ▶ button, you can start programme searching and following menu appears on the screen.



Aps Menu

By pressing ◀ / ▶ button in tv tuner menu, select the second icon. aps menu appears on the screen.

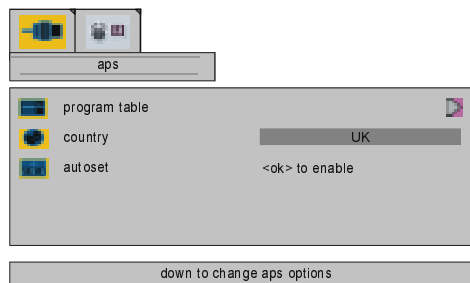

program table

By pressing ▲ / ▼ button, select **program table**. "right/left to enter program table" is seen on the screen. By pressing ◀ / ▶ or "OK" button, you can enter the following program table.

Programme table is also entered directly by pressing the  button.

program table		
01 CNN	11	21
02 R AI2	12	22
03 SAT	13	23
04 R AI3	14	24
05 TV5	15	25
06 ZDF	16	26
07 RA1	17	27
08 C02	18	28
09 S07	19	29
10 C05	20	30

Delete Insert Name

Moving cursor to four directions you can reach 30 programmes in the same page. By scrolling the pages up or down by pressing the navigation buttons you can select all the programmes in TV mode (except the AV mode).

In program table, ▲ / ▼ buttons work like "Direction Up" and "Direction Down". By cursor action, programme selection is done automatically.

Programme number is between 01 and 99. 00 is not displayed on program table. Programme Name has a name string with 5 characters. After autotest process the Programme Names are set to "C02" or "S07" (channel type and channel number) or name of the tuned channel if defined.

At the bottom of the program table there is a programme sort functions section. Each function is activated by a colour button (seen above). By **Delete** you can delete programmes that you decided. **Insert** section is for inserting programmes into the other programmes' locations. **Name** allows changing the programme name.

Delete:

For "Delete" process, press the RED button. The following warning menu comes to screen. Pressing "M" button cancels the activated "Delete" process. Pressing "OK" button erases the selected programme from the programme list, and the programmes below shift one up.



Insert:

Select the programme which you want to insert by navigation buttons. Press GREEN button. By navigation buttons move the selected programme to the decided programme space and press GREEN button again.

Name:

To change the name of a decided programme that is selected, press the YELLOW button. The following menu comes to screen.

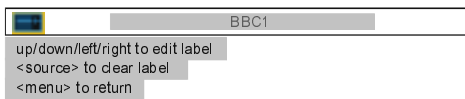

The first letter of the selected name is highlighted. To change that letter ▲ / ▼ button can be used, and to select the other letters, ◀ / ▶ button can be used. If the cursor is at the last letter of the Programme Name, pressing ▶ button moves the cursor to the beginning. On the contrary, if the cursor is at the beginning of the Programme Name, pressing ◀ button moves the cursor to the end.

country

By pressing ▲ / ▼ button, select **country**. "right/left to change country" is seen on the screen. By pressing ◀ / ▶ button, you should select the country where you are.

autoset

By pressing ▲ / ▼ button, select **autoset**. “<ok> to activate autoset” is seen on the screen. When ◀ / ▶ or “OK” button is pressed, the following menu appears on the screen. If you want to cancel autoset function, press “M” button. You return to **aps** menu.

If you press “M” button after autoset is started, program table appears on the screen.

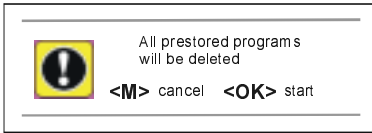

If “OK” button is pressed, autoset function starts and the following menu appears on the screen.

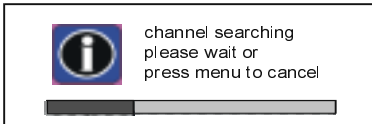

After autoset is finalized, the program table appears on the screen.

Source Select

By pressing ▲ / ▼ button, select **source select** in **settings** menu. “<ok> to activate source selection menu” is seen on the screen. By pressing ◀ / ▶ or “OK” button, you can enter the source select menu.

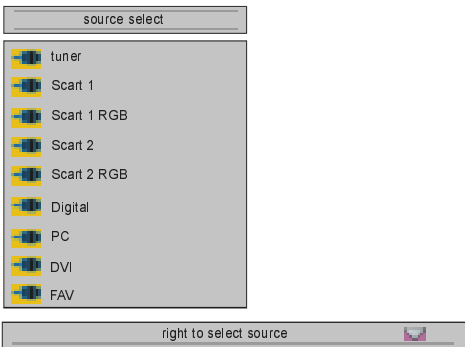

In source select menu, come on one of the sources by pressing ▲ / ▼ button and select it by pressing ▶ button. The source types are **tuner**, **Scart 1**, **Scart 1 RGB**, **Scart 2**, **Scart 2 RGB**, **Digital**, **PC**, **DVI**, **FAV** and **S-Video**.

Other Features (Analogue TV)

TV Status

Programme Number, **Programme Name** and **Sound Indicator** are displayed on the upper right side of the screen. **Source** is also displayed with them on the right bottom side of the screen. They are displayed after programme change during 3 seconds.

P 01 Programme Number

PR_01 Programme Name (5 characters)

These OSD's are displayed when a new programme is entered by digit button, by pressing “P<P” button or “-P/CH” or “P/CH+” button or “TV/TV” button.

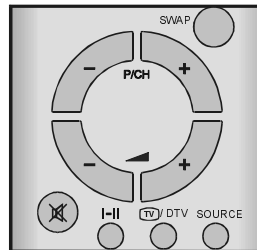

Previous Programme

- Press "P<P" (Previous Programme) button to select the last selected programme. This button provides swapping between last two selected programmes. For example, select programme 8, then select programme 2. Now, if you press "P<P" button, programme 8 will be selected. If you press the same button again, programme 2 will be selected and so on.

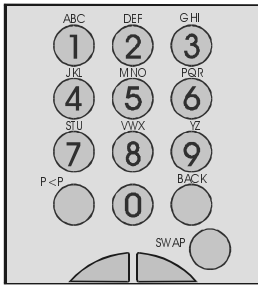

Freeze Picture

You can freeze the picture on the screen by pressing “OK” button.

Sound Indicator

The alternatives of the indicator are **Mono**, **Stereo**, **Dual A** and **Dual B**. This indicator is displayed under the programme number indicator on the screen. “I-II” button is used to select **Mono**, **Stereo**, **Dual A** or **Dual B**.

MONO

In **Mono** broadcast or in forced-mono (for stereo broadcast).

STEREO

In **Stereo** broadcast.

DUAL A

If dual broadcast is detected, **Dual A** is selected in default and also can be selected as **Dual B** by remote control.

DUAL B

If **Dual B** is selected by remote control.

Mute Indicator

It is placed in the upper left side of the screen when enabled.



To cancel mute, there are two alternatives, the first one is pressing “X” button, thus the volume is set to the preceding value, and the second one is increasing/decreasing the volume level, thus it starts from the previous level to increase/decrease.

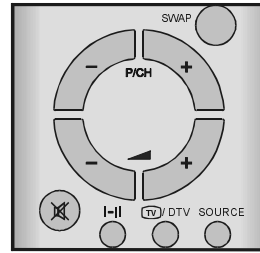

AV Modes

By pressing the “SOURCE” button or via **source select** menu, you can switch your TV to AV modes (except being in Teletext). Pressing this button will consecutively switch the TV in one of the optional AV modes: **Tuner**, **Scart 1**, **Scart 1 RGB**, **Scart 2**, **Scart 2 RGB**, **Digital**, **PC**, **DVI**, **FAV** and **S-Video**.

While watching VCR; **vcr** item in **options** menu should be set to **on**.

In order to quit the AV mode press the “TV/DTV”, digit buttons or “-P/CH” or “P/CH+”.

“HD Ready”

“HD Ready” offers a well balanced approach which responds to viewers’ and broadcasters’ needs for certainty regarding interoperability with future HD receiver products.

Your TV has “HD Ready” feature, so it supports analogue YPbPr (component) and DVI (or HDMI) as a HD input format to allow full compatibility with HD video sources.

Teletext

Teletext is an information system that displays text on your TV screen. Using the Teletext information system you can view a page of information on a subject that is available in the list of contents (index).

On screen display is not available in text mode.

Contrast, brightness or colour control is not available, but volume control is available in text mode.

Teletext mode is not available for pip layout option.

To Operate Teletext

- Select a TV station on which Teletext is being transmitted.
- Press “” button. Usually the list of contents (index) is displayed on the screen.

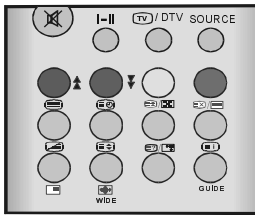

To Select A Page Of Teletext

- Press the appropriate digit buttons for the required Teletext page number.

The selected page number is displayed at the top left corner of the screen. The Teletext page counter searches until the selected page number is located, so that the desired page is displayed on the screen.

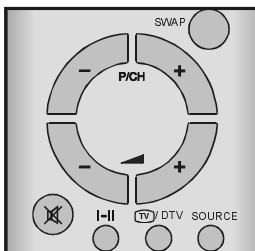



- Press “**P/CH +**” button to move the Teletext screen forward one page at a time.
- Press “**- P/CH**” button to move the Teletext screen backward one page at a time.



To Select Index Page

- To select the page number of the index (generally page 100), press “” button.



To Select Teletext With A TV Programme

- Press “” button. The text is now superimposed over the programme on the screen.
- Press “” button again to return to the Teletext page.

To Select Double Height Text



- Press “” button for the top half of the information page to be displayed in double height text.
- Press “” button again for the bottom half of the information page to be displayed in double height text.
- Press “” button once more for the full page of normal height text.

To Reveal “Concealed” Information

- Pressing “” button once will reveal answers on a quiz or games page.
- Pressing “” button again will conceal the revealed answers.



To Stop Automatic Page Change

The teletext page you have selected may contain more information than what is on the screen; the rest of the information will be displayed after a period of time.



- Press “” button to stop the automatic page change.
- Press “” button again to allow the next page to be displayed.

To Select A Subcode Page



Subcode pages are subsections of long Teletext pages that can only be displayed on the screen one section at a time.

- Select the required Teletext page.
- Press “” button.
- Select the required subcode page number by pressing four digit buttons (e.g. 0001).
- If the selected subcode page is not displayed in a short time, press “” button. TV programme will be displayed on the screen.
- Teletext page number will be displayed on the upper left corner of the screen when the selected page is found.
- Press “” button to display the selected Teletext page.

To Exit Teletext

- Press “” or “/DTV” button. The screen will switch to TV mode.

To Display The Time

- While watching a TV programme with Teletext transmission press “” button. The current time information, captured from Teletext will be displayed on the screen.
- Press “” button again to remove the time from the screen.
- If the programme being watched does not have Teletext transmission, no information will be displayed.

Fasttext

Your TV supports the 10 page Teletext system. When the page number of any of the 10 pages in memory is entered, the system will not search for the requested page; instead it will display the page automatically. If the requested page is not in memory, the system will search for the requested page number and save the 10 pages including the requested page into memory after finding it.

For Fasttext

The subject-heading for the information may have a particular colour.

- Press an appropriate **RED, GREEN, YELLOW** or **BLUE** button in order to reach the relevant page quickly.

For TOP text

TOP text mode of operation will be activated automatically according to the transmission.

- If TOP text transmission is present, colour coded buttons will appear in status row.
- If TOP text transmission is not present, status row will not appear.

The subject-heading for information may be located in colored box.

In Top mode the “-P/CH” or “P/CH+” commands will request the next or previous page respectively. If TOP text transmission is not available, in case of operation of these commands, wraparound occurs. For example page 100 appears to be one greater than page 199.

Connect Peripheral Equipment

There is a wide range of audio and video equipment that can be connected to your TV.

The following connection diagrams show you where the different (Optional) equipment should be connected at the back or right side of the TV.

Via The Euroconnector

TFT TV has 2 Euroconnector sockets. If you want to connect peripherals (e.g. video, decoder, etc.) which have Euroconnectors, to the TV, use SCART 1 or SCART 2 inputs.

If an external device is connected via Euroconnector sockets TV is switched to AV mode automatically. If the signal is RGB, select RGB in the source select menu to view picture. If the external device is connected to SCART 1, choose **Scart 1 RGB**. If the external device is connected to SCART 2, choose **Scart 2 RGB**.

Via Ant Input

If you want to connect to your TV, peripherals like video recorders or decoders, but the device you want to connect does not have Euroconnector, you should connect it to the ANT input of the TV.

If the VCR is connected via antenna input it is suggested to use the Programme 0.

Decoder (optional)

Cable TV offers you a wide choice of programmes. Most of them are free, others are to be paid for by the viewer. This means that you will need to subscribe to the broadcasting organisation whose programmes you wish to receive. This organisation will supply you a corresponding decoder unit to allow the programmes to be unscrambled.

For further information ask your dealer. See also the booklet supplied with your decoder.

Connect a decoder with an aerial socket to the TV

- Connect the aerial cable.

Connect a decoder without an aerial socket to the TV

- Connect the decoder to the TV with a eurocable to **SCART 1**.

TV And Video Recorder

- Connect the aerial cables.

Better picture quality can be obtained if you also connect a eurocable to **SCART** sockets.

Playback NTSC

To use this option you can;

- Connect **NTSC VCR** player to Euroconnector at the rear side of the TV.
- Connect **NTSC VCR** player to RCA Jacks at the right side of the TV.

Then, press "**SOURCE**" button to select proper source.

Copy Facility

Source selection for **VCR** recording.

- Select **options** menu.
- Select **scart 2 out** source pressing "▲" / "▼" button.
- Select **Tuner** to copy the picture from tuner and **Digital** to copy the picture from **Digital** broadcast..
- Select **Scart 1** to copy the picture from SCART 1.

Search For And Store The Test Signal Of The Video Recorder

- Unplug the aerial cable from the aerial socket "**ANT**" of your video recorder.
- Switch on your TV and put the video recorder on the test signal. (See the booklet for your video recorder.)
- Enter the **tv tuner** menu in **settings** menu. Enter the **programming** menu in **tv tuner** menu and select **manual search**.
- Search for the test signal of your video recorder in the same way as you searched for and stored the TV signals. See **programming** menu. Store the test signal under programme number 0.

- Replace the aerial cable in the aerial socket “ANT” of your video recorder once you have stored the test signal.

Camera And Camcorder

To Connect To FAV Input

Connect your camera or camcorder FAV input at the right side of the TV.

- Connect your equipment to the TV via **VIDEO** (yellow), **AUDIO R** (red) and **AUDIO L** (white) inputs. You should connect the jacks to the input in the same color.

To Connect To S-VHS Input

Connect your camera or camcorder S-VHS input at the right side of the TV.

- Connect your equipment to the TV via S-VHS input and audio inputs of FAV inputs by using S-VHS cables.

Connect The Decoder To The Video Recorder

Some video recorders have a special euroconnector for decoder.

- Connect a eurocable to the euroconnector of your decoder and to the special euroconnector of your video recorder. See also the booklet of your video recorder.
- To connect your video recorder to the TV, see TV and Video Recorder section.

If you want to connect more equipment to your TV, consult your dealer.

Connecting Headphones

Use the stereo headphone socket at the right side of the TV, to connect headphones.

PC Sound Connection

Connect the PC Audio output to the TFT **PC Audio In** socket with a PC Audio connection cable.

Connecting the PC via VGA input

- Power off both computer and TV before making any connections.

- Connect the VGA cable to the VGA input of your TV and to the 15-pin connector on the rear of your computer.
- Tighten the screws on the plugs until the connectors are fastened securely.
- If you are using Windows operating system running on a PC with a Microsoft Plug&Play compatible video card, your system will select the appropriate timing for your monitor.

Connecting YPbPr (Component) via VGA input

“HD Ready” enables YPbPr (component) connection via VGA input.

- Use the given YPbPr-to-PC converter cable to connect YPbPr output of any device to PC input of your TV.

Connecting the PC via DVI (Digital Video Interface) input

To get the best possible picture quality you'll need to use the DVI sockets on both the TV and your PC. This allows the PC to send a pure digital signal straight from the graphics card to the TFT TV. As DVI-I type socket exists on the TFT TV, use a DVI-D or DVI-I cable for connection.

- DDC (Display Data Channel) and EDID (Extended Display Identification Data), which are used for Plug&Play compatibility, are supported. Hot Plug Detection is not supported.
- Low refresh rates like 60Hz and 72Hz should be used and native resolution should be preferred.
- The DVI interface supports HDCP (High bandwidth Digital Content Protection), therefore a HDCP DVD player can be used.

How to connect HDMI via DVI input

“HD Ready” enables HDMI connection via DVI input.

- Use an HDMI-to-DVI converter cable to connect HDMI to DVI input of your TV.

Antenna Connections

Outdoor Antenna Connections

VHF antenna

Method 1

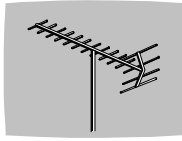

Round 75 ohm coaxial cable



Rear of TV

VHF/UHF antenna

Method 2

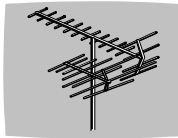

Flat 300-ohm twin lead cable

Round 75-ohm coaxial cable



Rear of TV

Peripheral Equipment Connections

HEADPHONE
(optional)



VIDEO

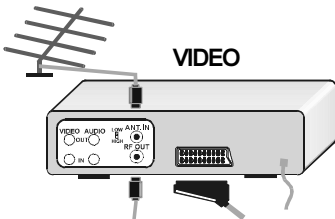

AUDIO

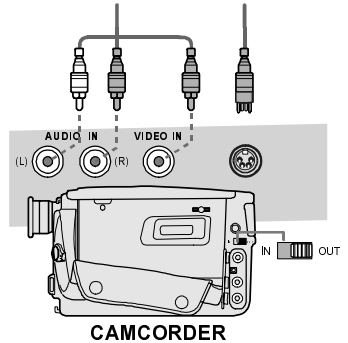
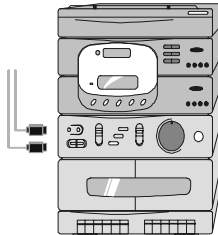

CAMCORDER

DECODER

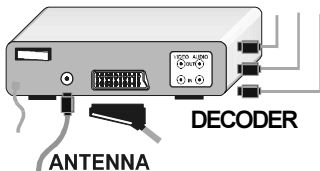

ANTENNA

FOR SATELLITE RECEIVER

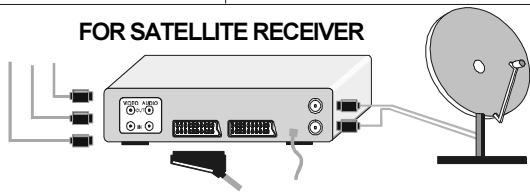

PC Input Typical Display Modes

The display has a maximum resolution of 1366 x 768, vertical sync. frequency range of 50-75 Hz and a horizontal sync. frequency range of 30-69 KHz.

The following table is an illustration of some of the typical video display modes.

Mode	Resolution		Frequency	
	Horizontal	Vertical	Hor. (kHz)	Ver. (Hz)
1	640	400	31.5	70
2	640	480	31.5	60
3	640	480	37.9	72
4	640	480	37.5	75
5	720	400	31.5	70
6	800	600	35.2	56
7	800	600	37.9	60
8	800	600	48.1	72
9	800	600	46.9	75
10	1024	768	48.4	60
11	1024	768	56.5	70
12	1024	768	60.0	75
13	1280	720	44.8	60
14	1280	768	47.8	60
15	1366	768	47.8	60

The native resolution of the TFT-LCD Panel is 1366 x 768. Therefore using Mode 15 is advised to get the best PC input display quality.

DVI INPUT TYPICAL DISPLAY MODES

The display has a maximum resolution of 1280 x 720, vertical sync. frequency range of 50-60 Hz and a horizontal sync. frequency range of 15-45 KHz.

The following table is an illustration of some of the typical video display modes.

			H Freq (khz)	V Freq (Hz)
			15,7	60 hz
			15,6	50 hz
			28,2	50 hz
			33,7	60 hz
 				
			31,5	60 hz
			31,5	60 hz
			31,5	60 hz
			31,2	50 hz
			31,2	50 hz
			37,5	50 hz
			45,0	60 hz

Tips

Care Of The Screen

Clean the screen with a slightly damp, soft cloth. Do not use abrasive solvents as they may damage the TV screen coating layer.

Poor Picture

Have you selected the correct TV system? Is your TV set or house aerial located too close to the loudspeakers, non-earthed audio equipment or neon lights, etc.?

Mountains or high buildings can cause double pictures or ghost images. Sometimes you can improve the picture quality by changing the direction of the aerial.

Is the picture or Teletext unrecognisable? Check if you have entered the correct frequency.

The picture quality may degrade when two peripherals are connected to the TV at the same time. In such a case, disconnect one of the peripherals.

No Picture

Is the aerial connected properly? Are the plugs connected tightly to the aerial socket? Is the aerial cable damaged? Are suitable plugs used to connect the aerial? If you are in doubt, consult your dealer.

No Picture means that your TV is not receiving any transmission. Have you pressed the correct buttons on the remote control? Try once more.

Sound

You can not hear any sound. Did you perhaps interrupt the sound, pressing "X" button? Are external speakers connected to the TV?

Sound is coming from only one of the speakers. Is the balance set to one direction extreme? See **audio** menu.

Remote Control

Your TV no longer responds to the remote control. Press the "TV" button on the remote control once more. Perhaps the batteries are exhausted. If so you can still use the local buttons on the top of the TV.

Have you selected the wrong menu? Press "TV" button to return to TV mode or press "M" button to return to the previous menu.

No solution:

Switch your TV set off and on. If this does not work, call the service personnel; never attempt to repair it yourself.

Specifications

TV BROADCASTING

PAL I/I'

RECEIVING CHANNELS

VHF (BAND I/III)

UHF (BAND U)

HYPERBAND

CABLE TV (S1-S20/ S21-S41)

NUMBER OF PRESET CHANNELS 100

CHANNEL INDICATOR

On Screen Display

RF AERIAL INPUT

75 Ohm (unbalanced)

OPERATING VOLTAGE

230-240V AC, 50 Hz.

AUDIO

German + Nicam Stereo

AUDIO OUTPUT POWER (W_{RMS}) (%10 THD)

2 x 8

POWER CONSUMPTION (W)

170 W

< 3 W (Stand-by)

PANEL

16:9 display, 32" Screen Size

DIMENSIONS (mm)

DIMENSIONS (mm)				
D	L	H	Weight (kg)	
301	925	633	17.6	With foot
104	925	566	14.2	Without foot

Important Instruction

For your own safety read following instruction carefully before attempting to connect this unit to the mains supply.

MAINS (AC) OPERATION

The wires in the mains lead are coloured in accordance with the following code :

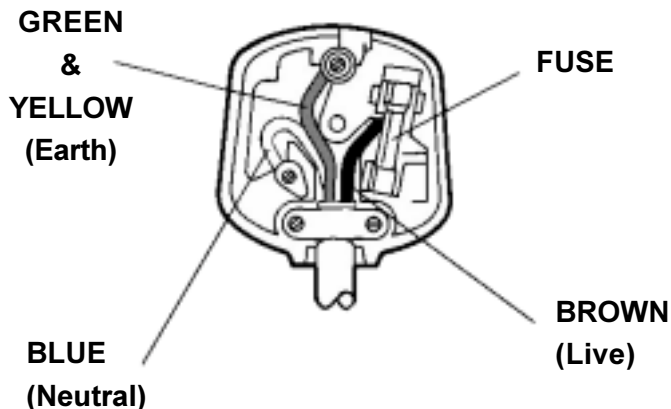

IMPORTANT

As the colours of the wires in the mains lead of this appliance may not correspond with the coloured markings identifying the terminals in your plug, proceed as follows:

The wire which is coloured green and yellow must be connected to the terminal which is marked with the letter E, or by the earth symbol, or coloured green or green and yellow.

The wire which is coloured blue or black must be connected to the terminal which is marked with the letter N or coloured Black.

The wire which is coloured brown or red must be connected to the terminal which is marked with the letter L or coloured Red.

For continued protection against risk of fire, replace only with same type and rating of fuse (ASTA approved 5A 250VAC fuse).

If your product is fitted with a moulded plug which requires replacement please cut off and dispose of safely, then rewire as shown above.

CAUTION

TO PREVENT ELECTRIC SHOCK DISCONNECT FROM THE MAINS BEFORE REMOVING COVER. NO USER SERVICEABLE PARTS INSIDE. REFER SERVICING TO QUALIFIED SERVICE PERSONNEL.

SAFETY PRECAUTION

THIS EQUIPMENT MUST BE DISCONNECTED FROM THE MAINS WHEN NOT IN USE. DO NOT ALLOW THIS UNIT TO BE EXPOSED TO RAIN OR MOISTURE.