

GRUNDIG

made for you

15" LCD TV + DVD PLAYER

GULCD15S/DVD

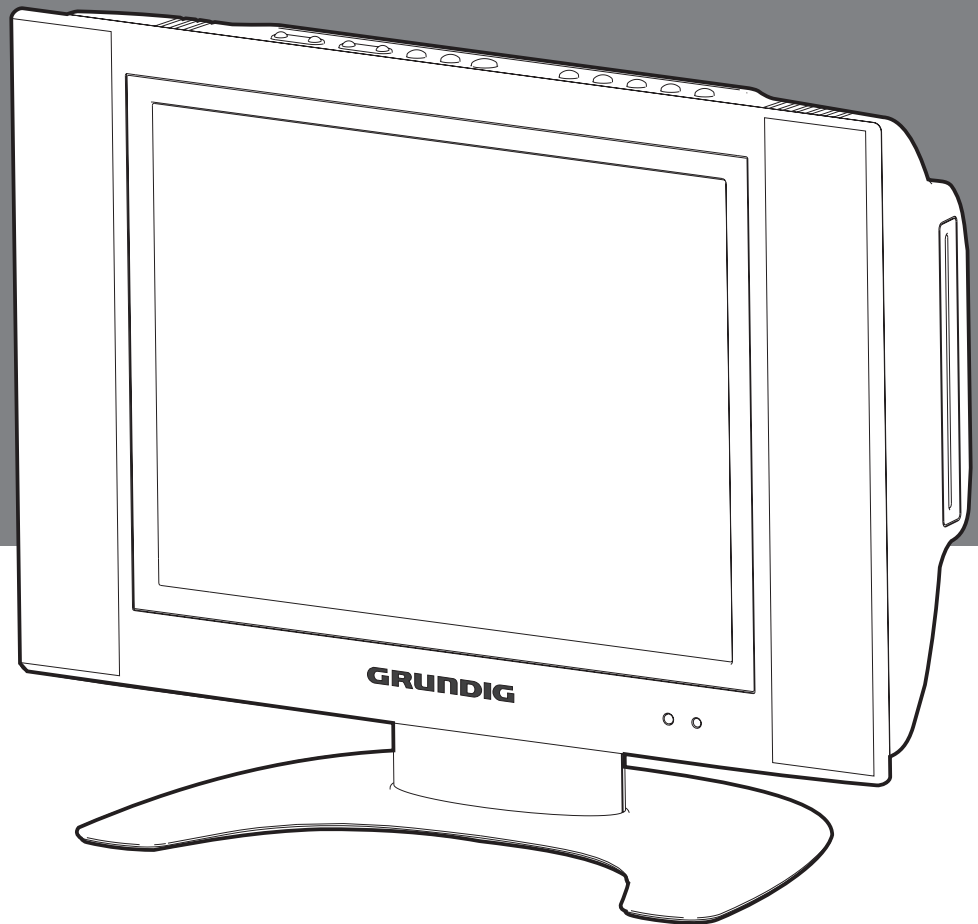

INSTRUCTION MANUAL

Thank you for buying a Grundig product

Website : www.grundig-uk.co.uk

Helpline : 0870 920 1101

Table of Contents

Important Safety Instructions	3
Conformity and Compliance	5
Precautions and Reminders	6
Wall Mounting the Set	8
Specifications	9
Remote Control Functions	10
Front Panel Buttons	11
Rear Panel Inputs	12
Quick TV Set-Up Guide	13
Quick Connecting Guide	14
PC Connection	16
On Screen Display (OSD) Menu	17
Menu Display Settings	17
Remote Control of TV and DVD	18
Screen & Inputs	19
Picture Settings	19
Color Menu	20
Audio Menu	21
Input Selection	22
TV Setting	23
<i>MTS (stereo mode)</i>	
<i>Manual Scan (manual tuning)</i>	
<i>Auto Scan (tune automatically)</i>	
<i>Set Channel (set channel skip)</i>	
<i>Label (re-name programmes)</i>	
<i>Favorite (sorting channel order)</i>	
<i>Tracking (fine tuning)</i>	
<i>TV System (to set your country)</i>	
<i>Automatic Frequency Control</i>	
DVD Operation and Settings	26
Basic Operations	26
DVD OSD Menu	27
Teletext Instructions	32
Troubleshooting	33

Important Safety Instructions

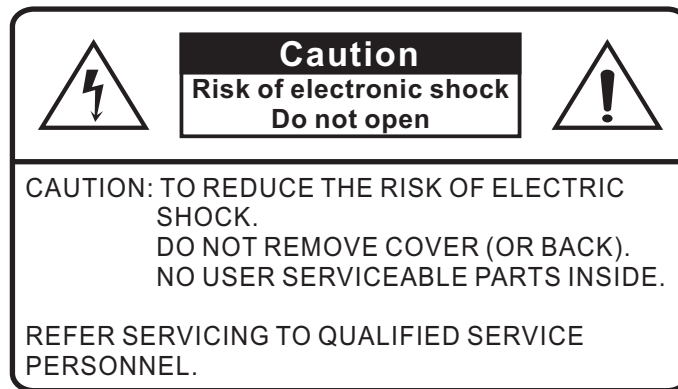

The lightning flash with arrowhead symbol within an equilateral triangle is intended to alert the presence of uninsulated "dangerous voltage" within the product's enclosure that may be of a sufficient magnitude to constitute a risk of electric shock.



The exclamation point within an equilateral triangle is intended to alert the user to the presence of important operating and maintenance (servicing) instructions in the literature accompanying the appliance.

Caution

1. Read these instructions.
2. Keep these instructions.
3. Heed all warnings.
4. Follow all instructions.
5. Do not use this apparatus near water.
6. Clean only with dry cloth.
7. Do not block any ventilation openings. Install in accordance with the manufacturer's instructions.
8. Do not install near any heat sources such as radiators, heat registers, stoves, or other apparatus (including amplifiers) that produce heat.
9. If the plug is not suitable or does not fit the socket in your home consult a qualified service agent.

Important Safety Instructions

10. Protect the power cord from being walked on or pinched particularly at plugs, AC power outlets, and the point where they exit from the apparatus.
11. Only use attachments/accessories specified by the manufacturer.
12. Use only with the cart, stand, tripod, bracket, or table specified by the manufacturer, or sold with the apparatus. When a cart is used, use caution when moving the cart/apparatus combination to avoid injury from tip-over.
13. Unplug this apparatus during lightning storms or when unused for long periods of time.
14. Refer all servicing to qualified service personnel. Servicing is required when the apparatus has been damaged in any way, such as power-supply cord or plug is damaged, liquid has been spilled or objects have fallen into the apparatus, the apparatus has been exposed to rain or moisture, does not operate normally, or has been dropped.
15. Use this product within 5°C - 40°C , and relative humidity 20-80%.
16. Unit should not be exposed to liquids of any kind.
17. Unplug the power supply unit from the mains when leaving unattended for a long period such as a holiday.
18. Contact service center if the picture displayed by the unit is getting dimmer.
19. Don't place the unit on an uneven surface. Make sure it is at least 6 inches from the wall.
20. Keep unit away from direct sunlight.
21. Don't put heavy materials on top of the unit.
22. Do not place unit in confined spaces such as a book case.
23. The rating plate is at the center of the back cover of the apparatus. It will not be seen when the apparatus is mounted on the wall.
24. Keep away from naked flames !
25. When using this product as a Computer monitor, health and safety experts recommend short frequent breaks rather than occasional longer breaks. For example a 5 - 10 minute break after an hour of continuous use is likely to be better than a 15 minute every 2 hours.
26. This product is designed for domestic use only and is therefore NOT suitable for commercial use.
27. Do not expose this television to dripping or splashing or place any object filled with liquids, such as vases on the television.
28. Do not use chemical solvents or strong detergents when cleaning this appliance as these cleaners may damage the cabinet.

Conformity and Compliance

ELECTRICAL CONNECTION

For your safety please read the following information.

Warning:

This appliance must be earthed by connecting to a mains power outlet with a protective earthing connection.

The appliance must be connected to a 220-240 volts 50 cycle AC supply by means of a three pin socket, suitably earthed and should be protected by a 3 amp fuse in the plug or a 3 amp fuse in the consumer unit.

Never use a fused mains plug without the fuse cover.
Never put a naked flame source near or on the television.

If the mains plug is unsuitable for the socket outlet in your home or is removed for any other reason, then the plug should be disposed of SAFELY to prevent the hazard of electric shock.

If a fuse is fitted to the plug, remove the fuse before throwing the plug away.

How to wire a UK mains plug.

The appliance is supplied with a BS1363 plug fitted with a 3 Amp fuse. should the fuse require replacement, it must be replaced with a fuse rated at 3 Amp and approved to BS1362.

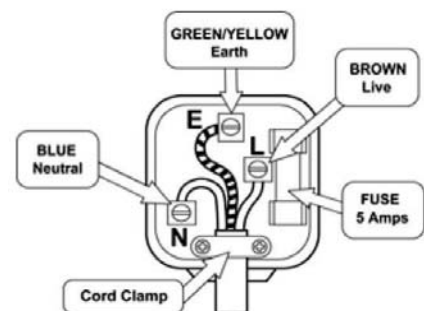

Important

The wire in the mains lead on this appliance are colored in accordance with the following code:

Green and Yellow Earth

Blue Neutral

Brown Live

As the colors may not correspond with the markings identifying the terminals in your plug, proceed as follows.

The green and yellow wire must be connected to the terminal in the plug which is marked with the letter E or with the earth symbol \perp or colored green and yellow.

The blue wire must be connected to the terminal marked N.

The brown wire must be connected to the terminal marked L.

Precautions And Reminders

Place unit on even surfaces.

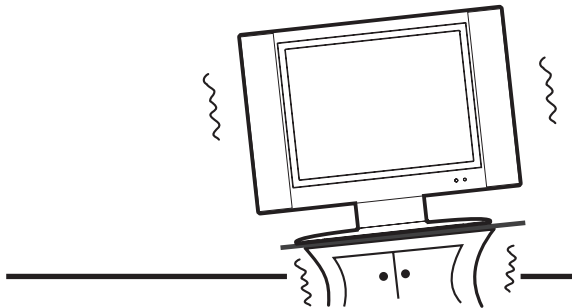

Don't place the TV in confined spaces or in a box when using it.

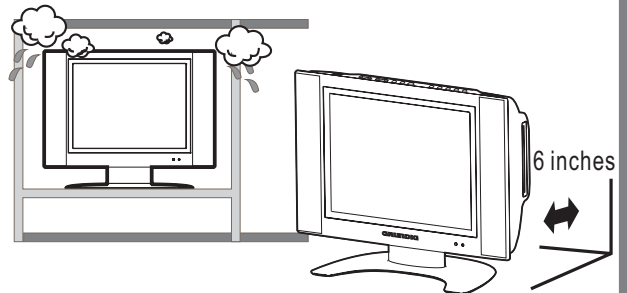

Unplug immediately if there is malfunction such as no picture, no video/audio, smoke, bad odor from TV.

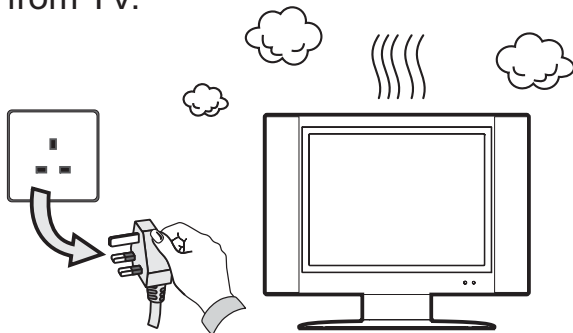

Unplug immediately if other foreign materials are put inside TV box or if the TV fell down.

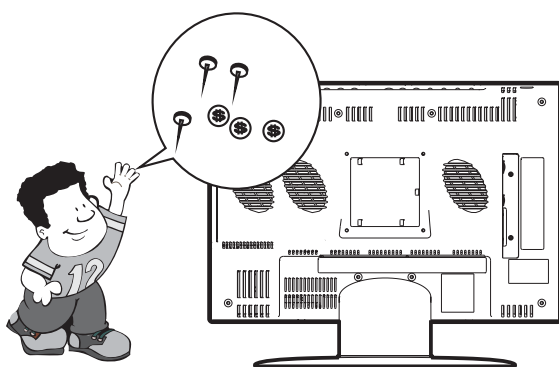
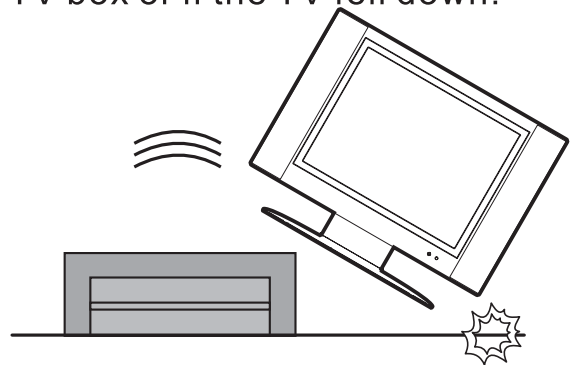

Don't Insert any object inside the TV box such as metals or flammable materials.

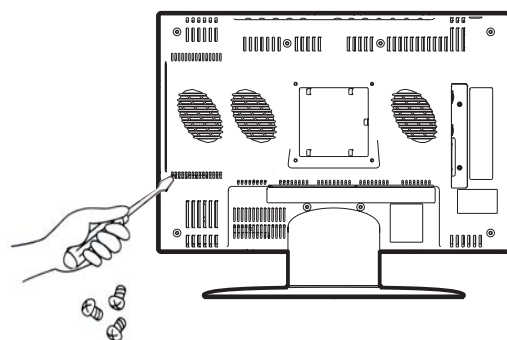

Don't open the TV cabinet.

Precautions And Reminders

Remember to unplug the power cord from the power outlet before cleaning the display unit. Only use recommended cleaners do not allow water to remain on the screen as it could cause permanent damage. Only use a lightly dampened cloth to clean the LCD screen.



Always remember to protect the screen from finger prints.
Do not use chemical solvents.

Do not cover or block any vents and openings. Inadequate ventilation may shorten the life of the display unit or cause overheating.

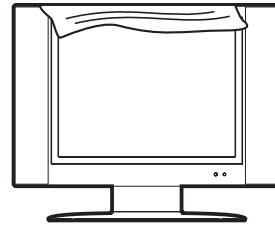

Make sure to unplug the unit when not in use for a long period of time (days).

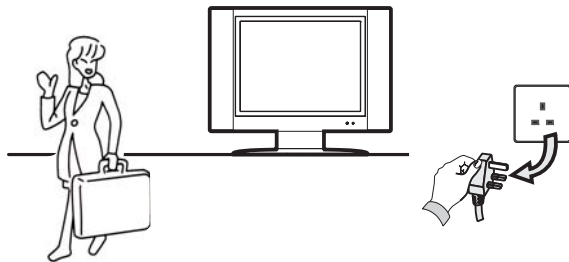

Avoid direct sunlight, dusty, high humidity and smoky areas.

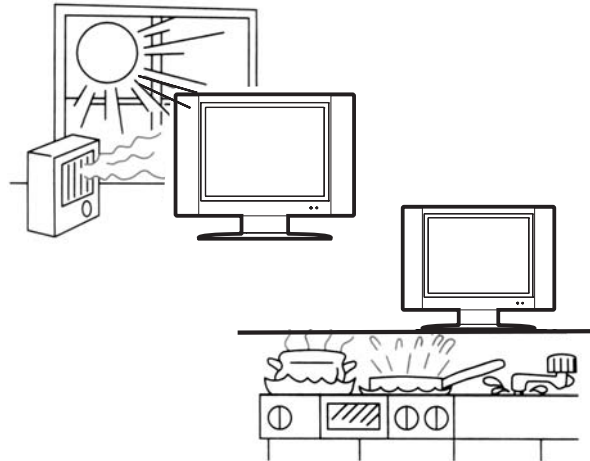

Notice for Remote Controller

Avoid Dropping

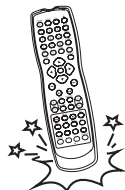

Avoid Liquids



Avoid Aerosol Cleaners



Wall Mounting the Set

The wall mount set (Optional)

Contact a professional installer if you are unsure about wall mount installation. Improper installation may cause injury and damage the display unit.

Caution:

When removing unit stand, place the display panel face down on a soft fabric to avoid damaging the unit.

Wall Mount Procedures

Use standard VESA plate mounting for wall mount. Please mount this product solidly on the wall or pole.

1. Remove the back cover of the base stand.
2. Loosen screws on base stand.
3. Detach TV from the base stand.
4. Wall mount the set.

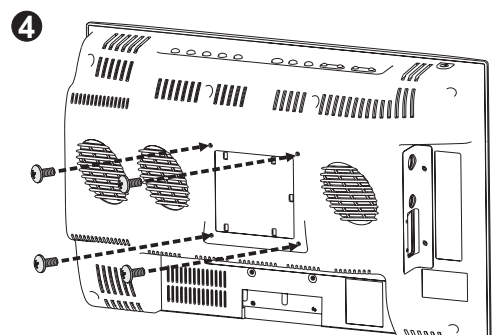
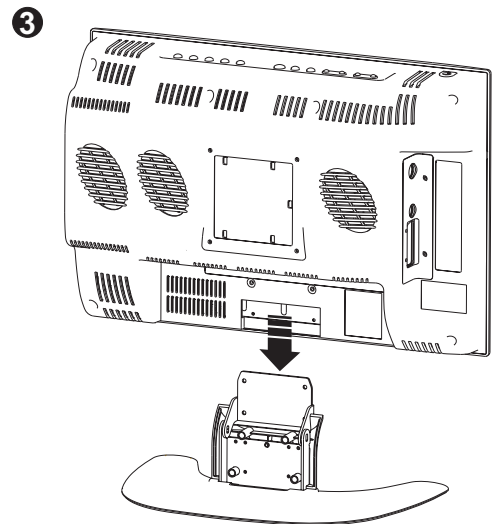
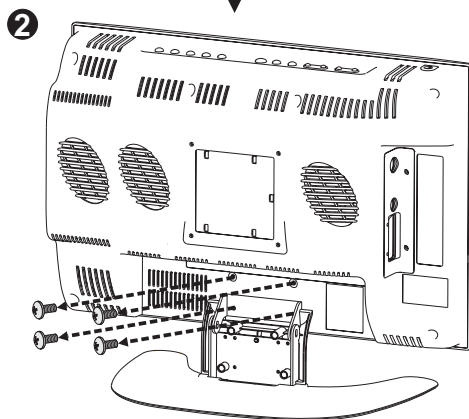
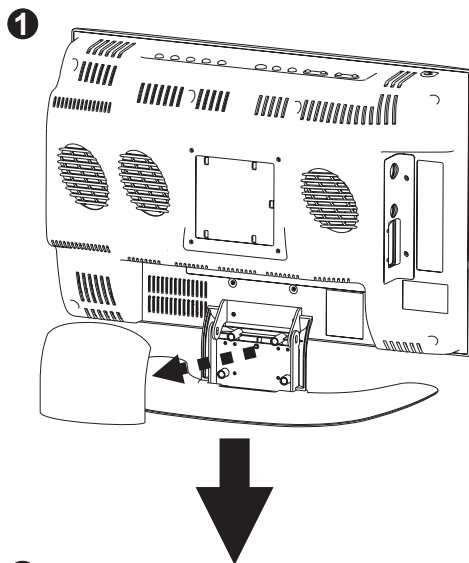

The holes for VESA plate mounting (Total 4 holes)
(Screws and vesa plate)

Warning:
To prevent injury, this apparatus must be securely attached to the wall in accordance with the installation instructions.

Specifications

Model No.		GULCD15S/DVD
Panel	Panel Size	15"
	Aspect Ratio	4:3
	Resolution	1024 x 768(XGA)
	Brightness	250 nits
	Contrast Ratio	500:1
	Viewing Angle (H/V)	120/100
	Response Time(Tr+Tf)	25ms
TV function	RF system	PAL,SECAM
	Broadcasting System	B/G,D/K,I,L/L'
	Channel Coverage	46.25MHz~862.25MHz
Video System	Type	PAL,SECAM,NTSC3.58,4.43
VBI support	Teletext	TOP/FLOF/WST
	Closed Caption	Yes
Video Feature	De-Interlace	3D
	Signals Supported	Component (576i), HD via Component (576p/720p), Composite, Y-C, YPbPr, RF
Audio Feature	Stereo System	A2(B/G,D/K)/NICAM(B/G,D/K,I,L/L')
	Volume/Bass/Treble/Mute control	Yes
	Audio Input	AV, SCART, Tuner, Line
	Speaker Output	2 x 2 W
I/O Connection	RF-IN	1
	SCART-IN	1
	Component(YPbPr)-IN	1
	AV -IN	1
	S-Video IN	1
	PC - D-Sub IN	1
	Line - IN(for PC)	1
User Feature	ATS(Auto tuning system)	Yes
	CANAL+ function	Yes (France only)
	Sound Auto Detect Display	Yes
	Auto Adjust(PC mode)	Yes
	Channel Editing	Yes
User key(TV)	Channel Up	Yes
	Channel Down	Yes
	Volume Up	Yes
	Volume Down	Yes
	Menu	Yes
	Source	Yes
	Power	Yes
User key(DVD)	EJECT	Yes
	FR	Yes
	FF	Yes
	STOP	Yes
	PLAY/PAUSE	Yes
IR control	TV/DVD	Yes
DVD	Slot-in,(MPEG2)	Yes
Power Supply	AC adapter(AC100~240V)	DC 12V/5A
Power consumption		40W
Dimensions	W x H x D	450mm x 352mm x 190mm
Weight(net)		5.2 kg
Accessories		Remote control unit, power cord, manual, battery, power adapter

Remote Control Functions

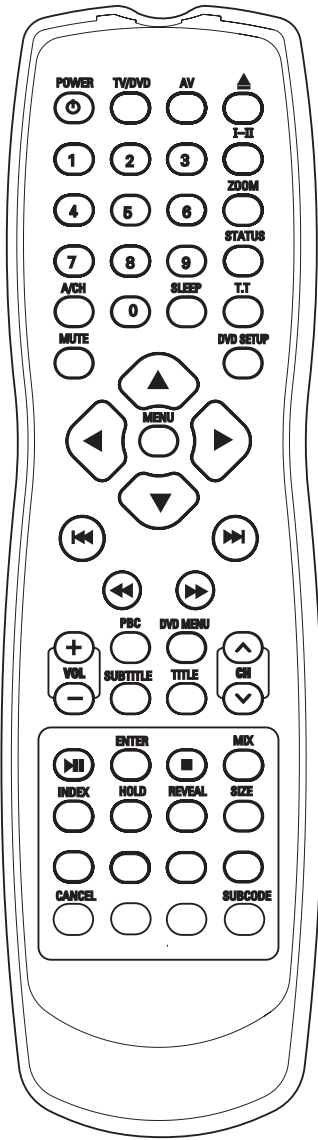

Key(s)	Functionality
	Turns the TV on and off.
TV / DVD	Press to switch remote control inputs between TV or DVD mode.
AV	Use to select an input source.
	Opens and closes the disc tray.
Number (0-9)	Use number (0-9) buttons to create stations and preset programs.
I-II	Changes the sound output for TV programs. Switch between Stereo, SAP (Second Audio Program), or Mono for audio simulcasts. The TV program must support the output option. The key is exit in OSD function.
ZOOM	Press to change screen size.
STATUS	Press to display the current channel and audio/video settings.
A / CH	Returns to the previous channel.
SLEEP	Performs the sleep timer function : press button to set timer to 30, 60, 90, 120 minutes or OFF settings.
T.T	Press to access Teletext function.
MUTE	Press to temporarily cut off the sound.
DVD SETUP	Displays the DVD OSD menu.
Cursor keys (▲ ▼ ► ◀)	To move the cursor up/down/right/left to scroll through a list of options.
MENU	Displays the main on-screen menu.
►► ◀◀	Press to increase/decrease or menu control key. Also advances to the next/preceding chapter or track.
►► ◀◀	searches forward/backward through the disc.
(VOL+, VOL-)	Press to increase or decrease the volume, or left and right in menu control.
PBC	VCD 2.0 playback PBC function on/off.
DVD MENU	When playing a disc, displays the disc's menu.
(CH+, CH-)	Cycle through available channels in either up/down sequence, or up and down in menu control.
SUBTITLE	Accesses the subtitle icon in the info display.
TITLE	Accesses the DVD disc guide.
II►	Disc play/pause.
ENTER	Press to select options in DVD disc menu.
■	Stops playback.
MIX	To overlay text onto a TV programme.
INDEX	Access the Teletext index.
HOLD	Stop from advancing to the next Teletext subPage. Press again to continue moving through the Teletext sub pages.
REVEAL	Show hidden information. Press again to conceal the information.
SIZE	Change the size of Teletext.
RED, GREEN, YELLOW, BLUE	Direct access Teletext linked page key.
CANCEL	Exit Teletext mode.
SUBCODE	Select a Teletext sub page, then enter desired page number to begin page search.

Front Panel Buttons

Front Panel

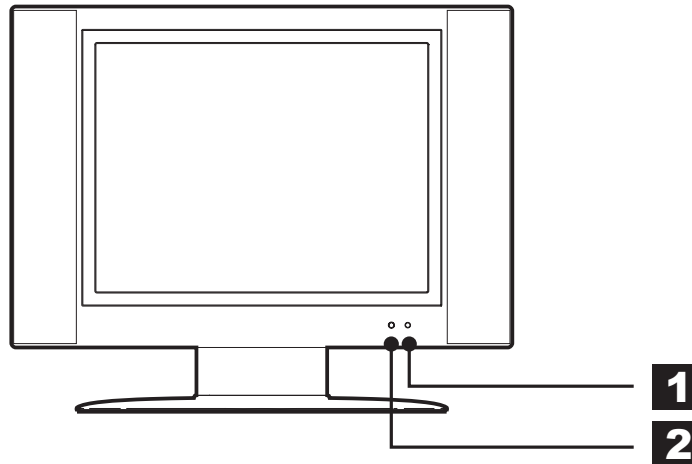

Function Keys

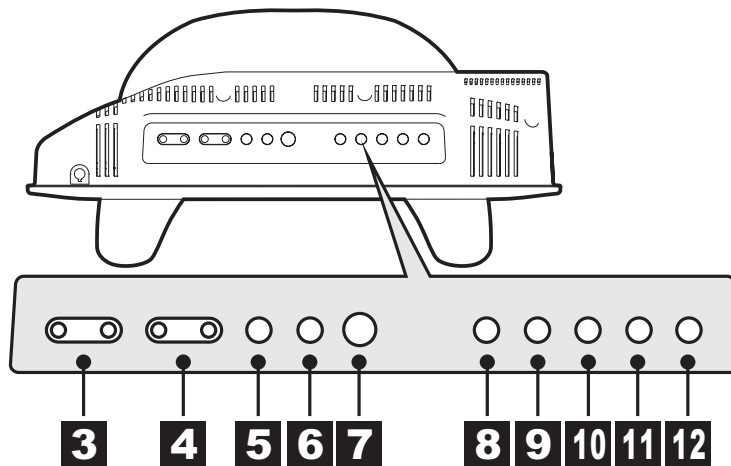

- 1 Power indicator:**
Stand by mode displays amber. Power on displays green.
- 2 IR Receiver:**
Aim at the IR receiver window when using Remote Controls.
- 3 Channels / Cursor Up/Down keys:**
Press - to select channels from high to low, and press + to select channels from low to high. When OSD menu displays, these two keys enable selection of menu items.
- 4 Volume Control / Setting keys:**
Press - to decrease volume, and press + to increase volume. When OSD menu displays, these two keys enable change of setting levels.
- 5 Menu key:**
Press to display the Menu. Press again to exit the Menu.
- 6 Source key:**
Press this button to cycle through:
TV → DVD → SCART → PC → HD → AV → S-Video modes.
- 7 Power key:**
Press once to turn on. Press again to return to stand by mode.
- 8 Play/Pause key:**
Disc play/pause and enter key.
- 9 Eject key:**
Opens and closes the disc tray.
- 10 Stop key:**
Press to stop DVD playback.
- 11 FF key:**
Press to search forward through the DVD.
- 12 FR key:**
Press to search backward through the DVD.

Rear Panel Inputs

Rear Panel

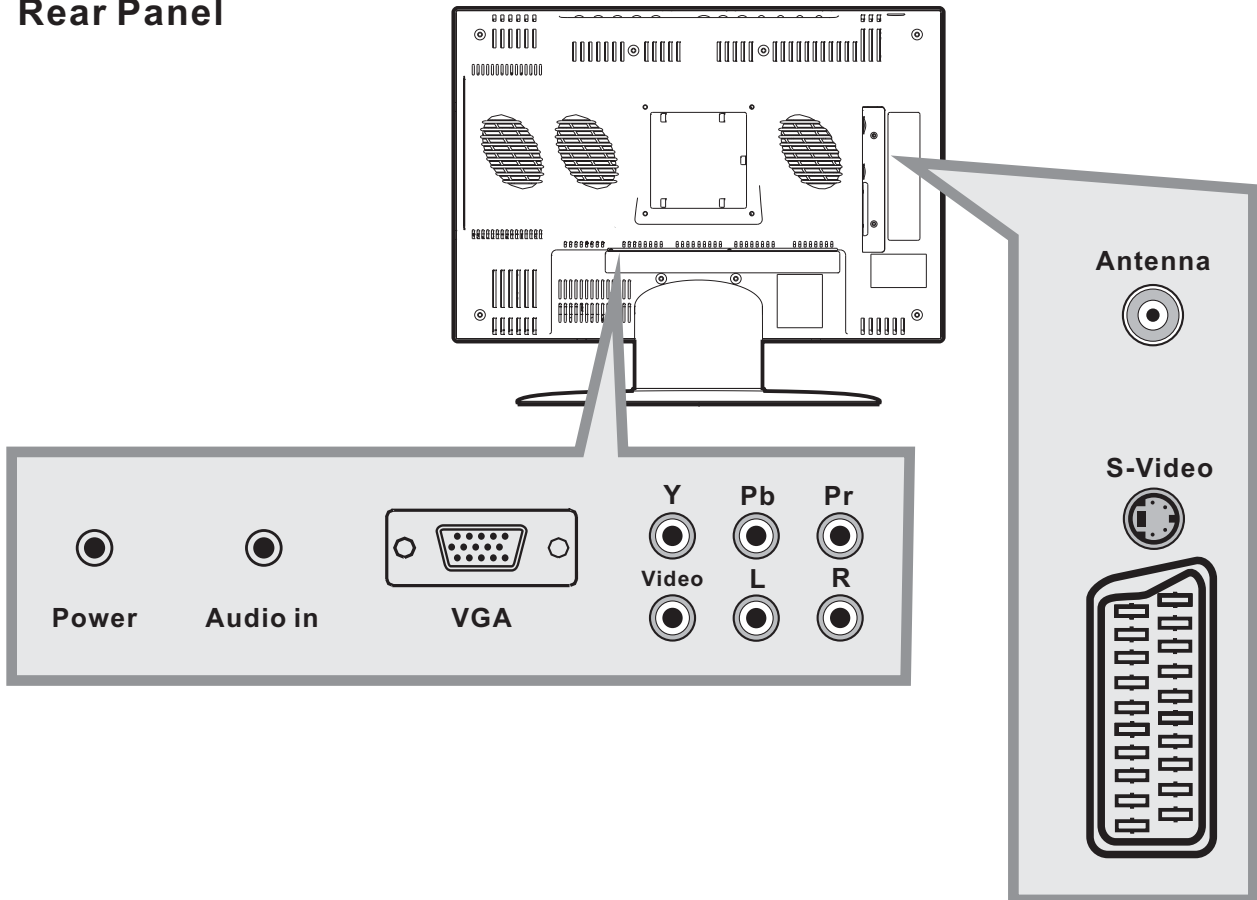

Antenna Input Socket : 75Ω type coaxial cable connector.

Y Pb Pr Input Socket : Connect appliances with component output.

AV (Video / L / R) Input Socket : Connect with DVD player or VCR AV output.

S-VIDEO Input Socket : Connect appliances with S-VIDEO output.

SCART Input Socket : Connect DVD player or VCR AV output.

VGA Input Socket : Connect with VGA socket of PC.

PC Audio Input Socket : Connect with Line Out socket of PC.

Power: Input socket connect with AC power cord.

Quick TV Set-Up Guide

Adjusting the view angle

Press down on the stand and gently adjust the set to a suitable viewing angle.
The LCD TV monitor can be tilted 10 degrees backward.

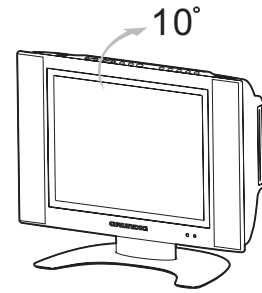

Power connection

1. Connect adaptor to power input of TV.
2. Connect adaptor to power cord.
3. Connect the other end of power cord to power supply.

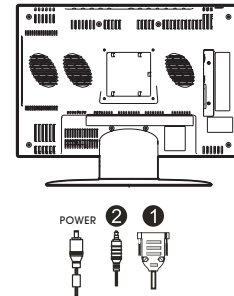



Connecting to An Aerial

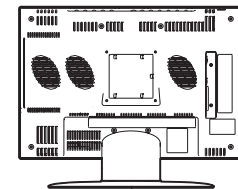



Connect antenna or CATV cable to the antenna port of the tuner box.



Turning ON/OFF the TV

1. If power input is connected correctly, the LED on the front panel becomes Amber (i.e. stand-by mode). Press the POWER button on the function panel OR press the red POWER button “” of the remote control. The TV will switch on and the LED on the front panel becomes green.
2. To switch the TV off, press the POWER button on the function panel OR press the red POWER button “” of the remote control. The TV will switch off and go to the stand-by mode.

Auto Scan channels

1. Press the AV key and select input source to TV.
2. Press the MENU key on the remote control to show the On Screen Display Menu (OSD).
3. Press   key to select the TV icon on the top of screen.
4. Press   key to high-light Auto Scan option. Then press  key to select the Auto Scan option.
5. Once scanning is finished, press MENU to exit.

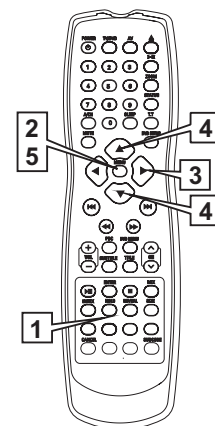

If you would like the channels on certain numbers please refer to 'Manual scan' on page 24.

Quick Connecting Guide

- This product includes SCART, AV, S-VIDEO, YPbPr input sockets to connect with DVD player, VCR, DV Camera to obtain better picture quality.
- Input jacks and source selection need to match correctly for display of correct picture.
- Video and Audio jacks are color-coded:

Video.....	Yellow (Y)
Audio (L).....	White (W)
Audio (R).....	Red (R)
Y.....	Green
Pb.....	Blue
Pr.....	Red

Connection Instruction

1. Connect home entertainment appliance with appropriate SCART / AV / S VIDEO / HD / PC input jacks.
2. Press AV key on the remote or the SOURCE button on the TV to select one of the following:
TV → SCART → PC → YPbPr → AV → S-VIDEO



Using SCART Input for DVD Player/ VCR

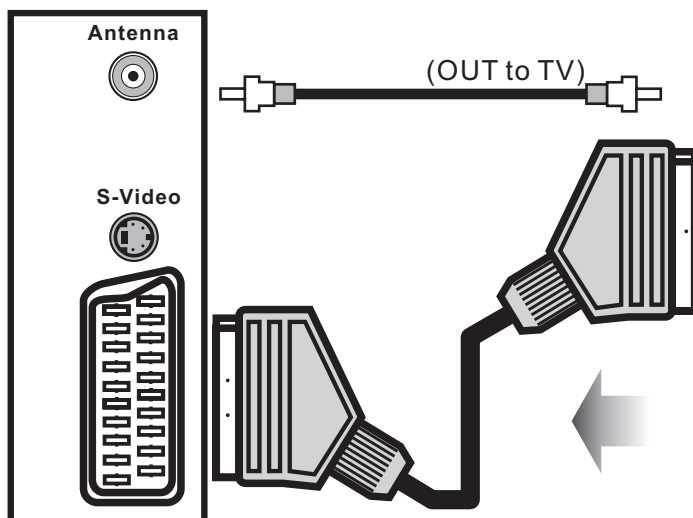

NOTICE!

Please refer to DVD player or VCR manual for more detailed connecting instructions.

Quick Connecting Guide

Using YPbPr Input for DVD Player / VCR

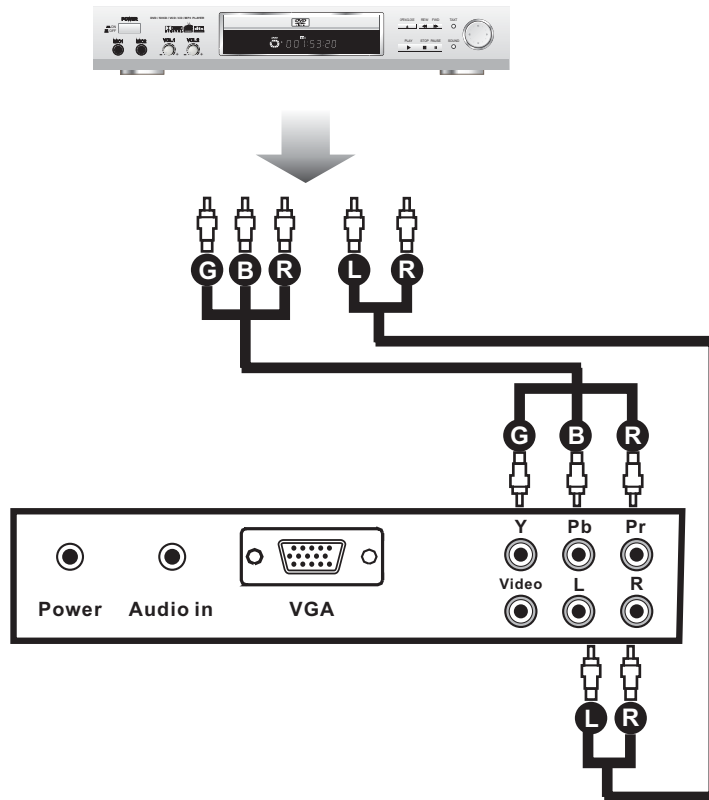

Using S-VIDEO for DVD Player / VCR

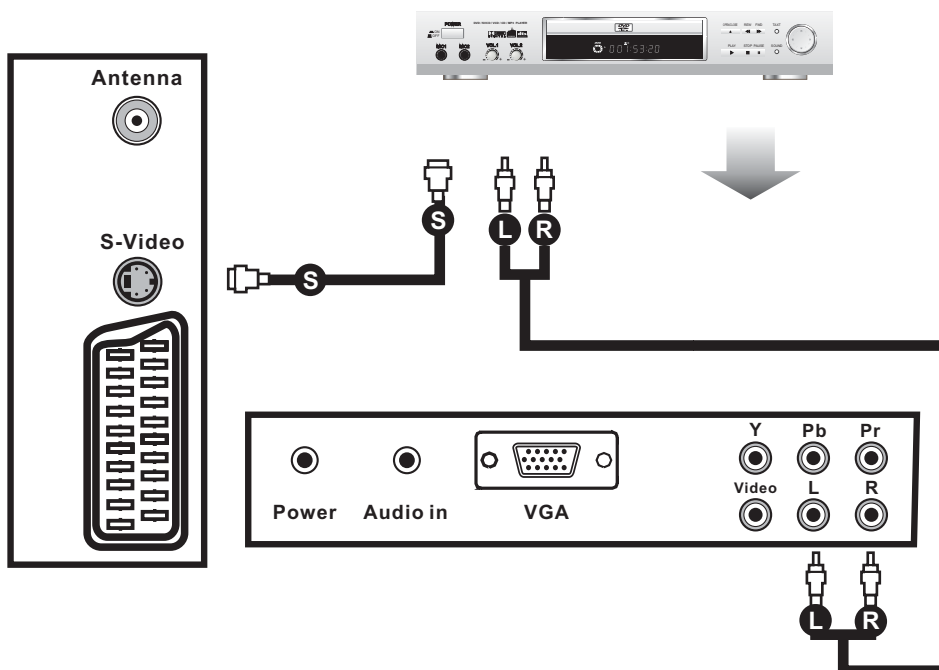

PC Connection

Connecting PC Instructions

1. Video Signal Connection:

Connect VGA signal cable to VGA input socket of the TV and VGA output of the computer.

2. Audio Signal Connection:

Connect audio signal cable to AUDIO IN jack on the TV and LINE OUT jack of the computer sound card.

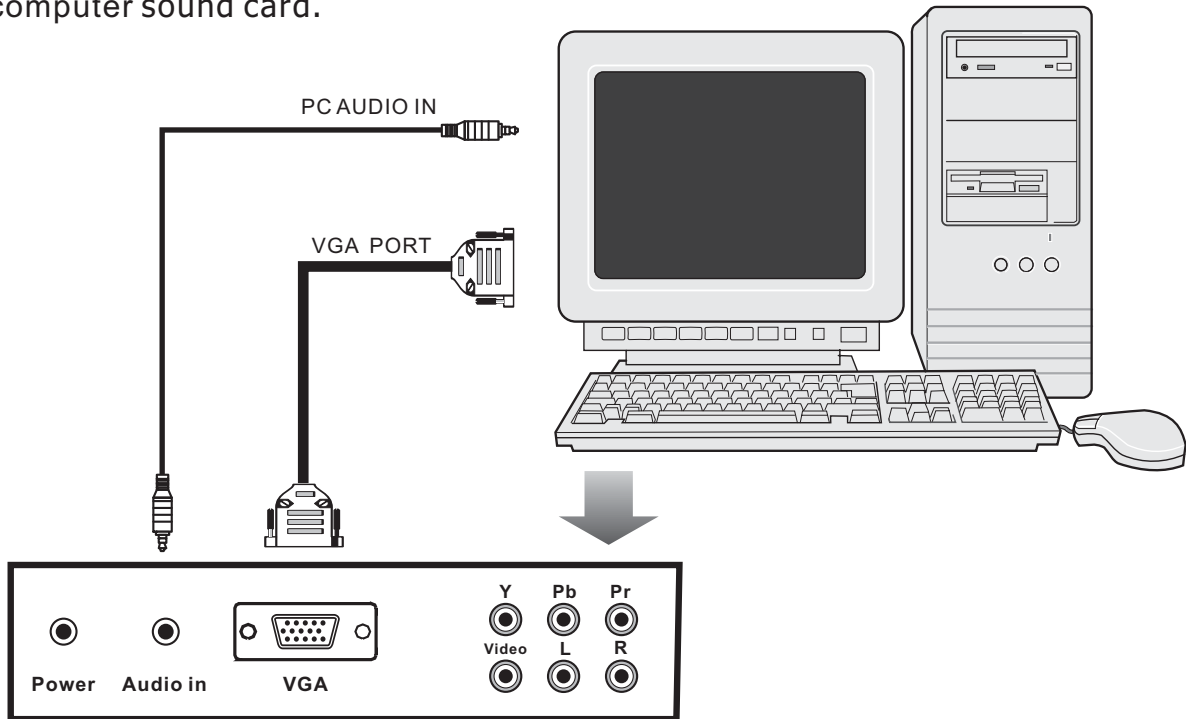

Operating Instructions

1. Turn on the TV with the power switch.
2. Press the AV button on the remote twice to select PC mode.
3. Turn on computer, and the PC Desktop will be displayed.

- When the user switches the PC to a resolution which is not listed, the screen will display the message "OUT OF RANGE". Please wait for 10 to 15 seconds, the computer will return back to the previous resolution.
- When the PC/VGA signal is lost, the power indicator will flash alternate colours, denoting a waiting condition. The user can switch the computer to another source or return to a supported VGA signal.

Supported Resolutions

MODE	Resolution	Refresh Rate
VGA	640X480	60
	640X480	75
SVGA	800X600	60
	800X600	75
XGA	1024X768	60
	1024X768	70
	1024X768	75

OSD Settings: Menu

(for all modes)

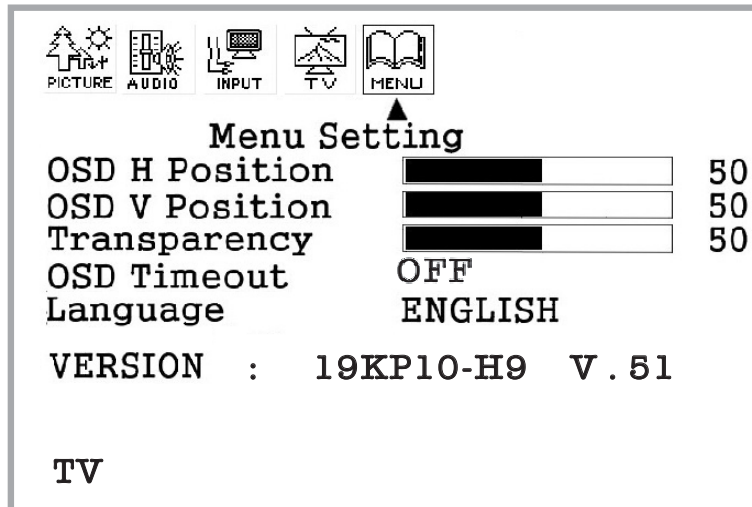

Refer to table for brief description of each option.

OSD H Position:	Adjust OSD horizontal position
OSD V Position:	Adjust OSD vertical position
Transparency:	Adjust OSD background transparency
OSD Timeout:	Adjust OSD showtime setting
Language:	Adjust OSD language settings (English/French/Dutch/Italian/German/ Czech/Slovak)
Version:	Display system information

MENU

Certain properties of the On Screen Display (OSD) can be changed from this menu. The above table describes the function of each option in this menu.

1. Press MENU on the remote.
2. Select the MENU option with the LEFT / RIGHT keys on the remote.
3. Select the option you want to change with the UP / DOWN keys on the remote.
4. Change the values of the selected option with the LEFT / RIGHT keys.
5. You can exit this menu by pressing the MENU key on the remote twice.

Remote Control of TV and DVD

The remote control has two modes of operation, one for TV and one for DVD. Switching between the two modes is achieved by using the TV / DVD button on the remote control.

The TV / DVD button works like a toggle switch. One press switches the remote to DVD mode and the second press switches the remote back to TV mode.

An indicator appears in the top left hand corner of the TV screen to tell you what mode the remote is in. If the wrong indicator appears just press the TV / DVD button again.

To see the DVD picture, press the TV / DVD button until the "TV RC" indicator appears on the top left of the screen then press the AV button once. After a short pause the DVD picture will appear. To operate the DVD player you must put the remote into DVD mode. To do this, press the TV / DVD button until the "DVD RC" indicator appears on the screen.

For DVD operation see page 26 and for TV operation see page 19.

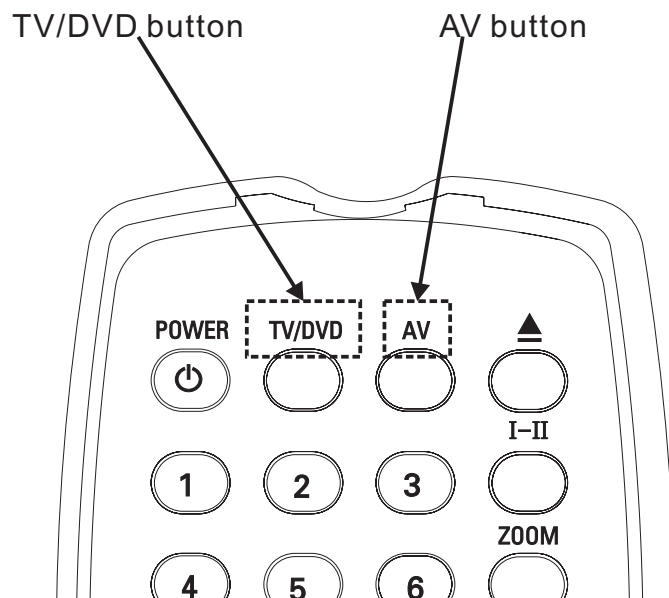

- To return to the TV picture or select a picture from an external input.
- 1) Press the TV / DVD button to see "TV RC" on the screen.
 - 2) Press the AV button to select the input you require (see page 22)

OSD Settings: Screen & Inputs

There are 3 sections in the OSD menu:

Press MENU button to show up the OSD menu.

Press MENU button again to exit.

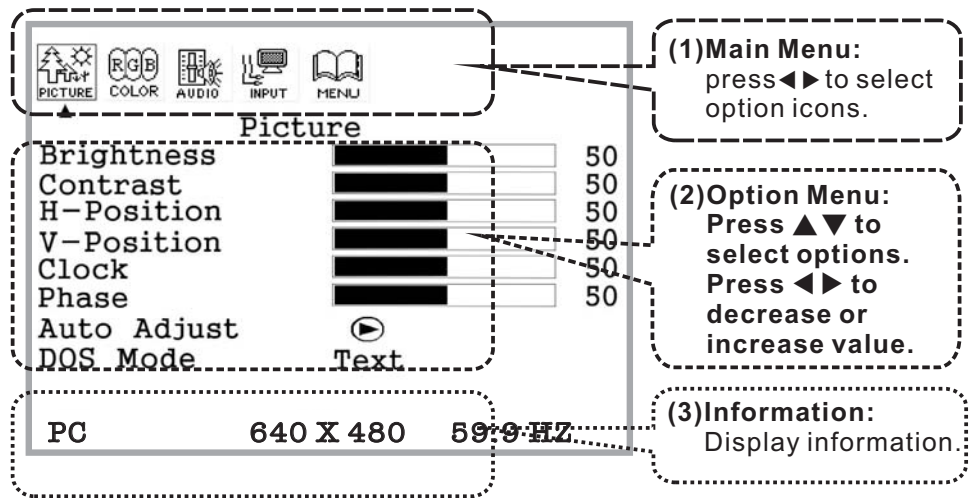

OSD Settings: Picture

(for AV, S-VIDEO, SCART, & TV input)

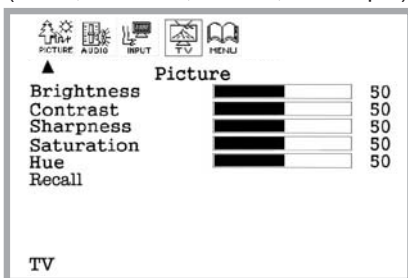

(for YPbPr input)

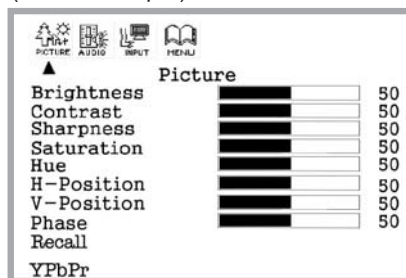

(for PC input)

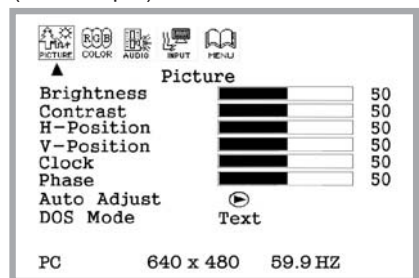

Refer to table for brief description of each option.

Brightness:	Brighten or darken picture
Contrast:	Deepen or soften picture
Sharpness:	Sharpen or soften picture
Saturation:	Adjust color saturation
Hue:	Adjust color intensity
H-Position:	Adjust horizontal position of the picture
V-Position:	Adjust vertical position of the picture
Phase:	Adjust phase
Recall:	Return to system default settings
Clock:	Adjust the Time and Date
Auto Adjust:	Adjust picture automatically
DOS Mode:	Change display system, Text/Graphic options

If you are not happy with your settings and cannot get the picture as you like you can return to factory default settings by selecting the RECALL option.

OSD Settings: Color

Press TV/DVD button to ensure remote is in TV mode (see "Remote Control of TV and DVD").

(for YPbPr input source)

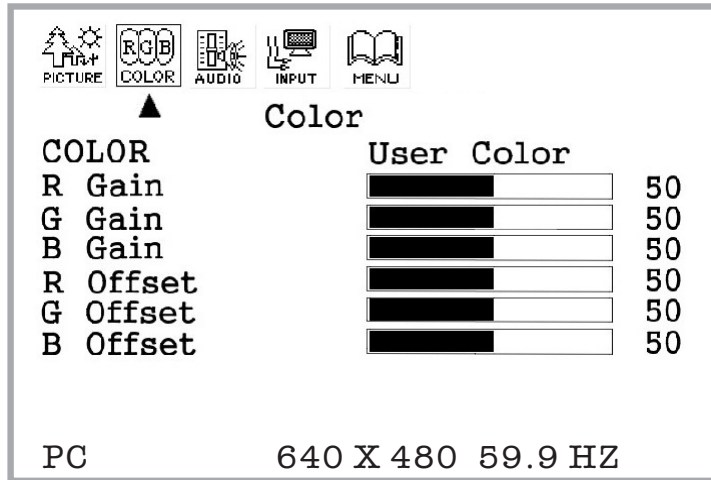

Refer to table for brief description of each option.

Color:	9300/6500/5500/User Color options
R Gain:	Increase Red Highlights
G Gain:	Increase Green Highlights
B Gain:	Increase Blue Highlights
R Offset:	Decrease Red Lowlights
G Offset:	Decrease Green Lowlights
B Offset:	Decrease Blue Lowlights

OSD Settings: Color

Color GAIN can be used to correct color casts in the highlights of a picture and color OFFSET can be used to correct color casts in the lowlights of a picture. Example, the "red gain" control will alter the red content in the brighter parts of the picture leaving the lower brightness parts unchanged and the "red offset" will alter the red content of the lower brightness parts of the picture leaving the brighter parts unchanged. The same applies for the Green and Blue options.

1. Press the MENU key on the remote.
2. Select COLOR with the RIGHT arrow key on the remote.
3. Select the option you want to change with the UP / DOWN keys on the remote.
4. Alter the values with the LEFT / RIGHT arrow keys on the remote.
5. You can EXIT this menu by pressing the MENU key on the remote twice.

NOTE:

When navigating the Menus you can use the controls on the TV, the Channel buttons can be used as the UP / DOWN (select option) and the Volume buttons can be used as the LEFT / RIGHT(alter value)

OSD Settings: Audio

Press TV/DVD button to ensure remote is in TV mode (see "Remote Control of TV and DVD").

(for ALL modes)

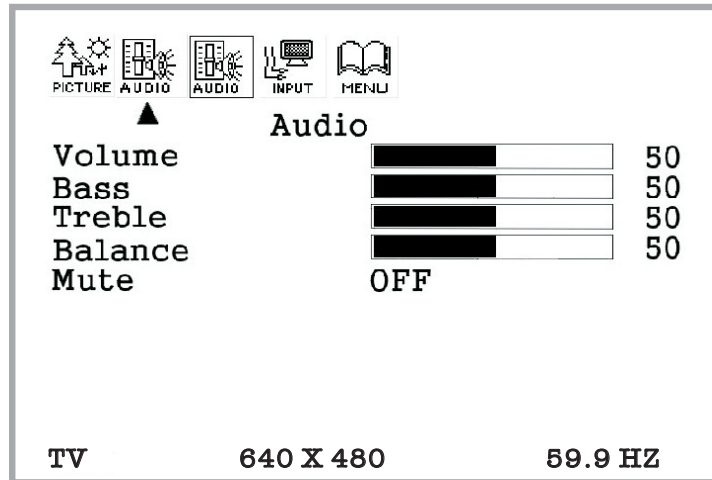

Refer to table for brief description of each option.

Volume:	Adjust sound volume
Bass:	Adjust lower-pitched sound performance
Treble:	Adjust higher-pitched sound performance
Balance:	Adjust to emphasise left or right speaker
Mute:	Temporary cut off sound

OSD Settings: Audio

From the AUDIO menu you can set various options for the sound. Volume, Bass, Treble and Balance levels can be changed, you can also mute the sound.

1. Press the MENU key on the remote.
2. Select AUDIO with the RIGHT arrow key on the remote.
3. Select the option you want to change with the UP / DOWN keys on the remote.
4. Alter the values with the LEFT / RIGHT arrow keys on the remote.
5. You can exit this menu by pressing the MENU key on the remote twice.

NOTE:

When navigating the Menus you can use the controls on the TV, the Channel buttons can be used as the UP / DOWN (select option) and the Volume buttons can be used as the LEFT / RIGHT(alter value)

OSD Settings: Input Selection

Press TV/DVD button to ensure remote is in TV mode (see "Remote Control of TV and DVD").

(for ALL modes)

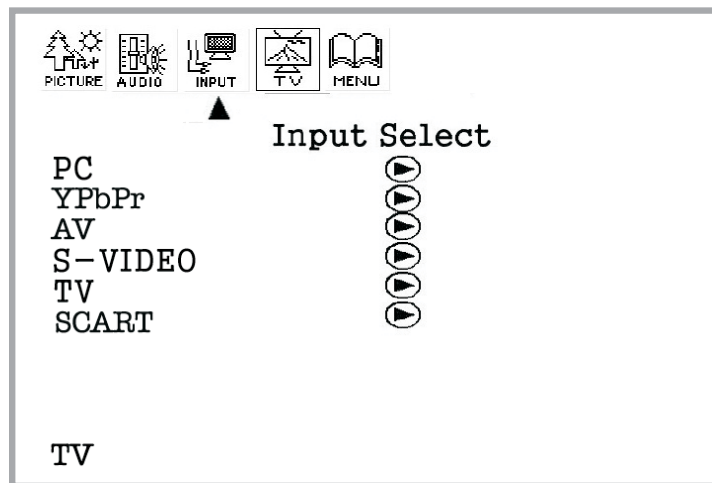

Refer to table for brief description of each option.

Input	Function	Peripheral Equipment
PC:	Change to PC(VGA) signal	PC (desktop/laptop)
YPbPr:	Change to YPbPr (Component) signal	VHS, DVD player, etc.
AV:	Change to AV (Composite) signal	VHS, DVD player, camcorder, etc.
S-VIDEO:	Change to S-VIDEO signal	VHS, DVD player, etc.
TV:	Change to TV signal	TV cable, TV signal box, etc.
SCART:	Change to SCART signal	VHS, DVD player, etc.

INPUT SELECTION

You can choose which input source to use directly from this menu option.

1. Press the MENU key on the remote.
2. Select INPUT with the RIGHT arrow key.
3. Select the input source you want to use from the available list.
4. Activate the selected source by pressing the RIGHT arrow key.
5. You can EXIT the source menu by pressing the MENU key twice.

OSD Settings: TV Setting

How to operate the on-screen menus and set-up the television.

Press TV/DVD button to ensure remote is in TV mode (see "Remote Control of TV and DVD").

(for TV mode)

This menu is only available when TV input is selected (see "Input selection" on previous page).

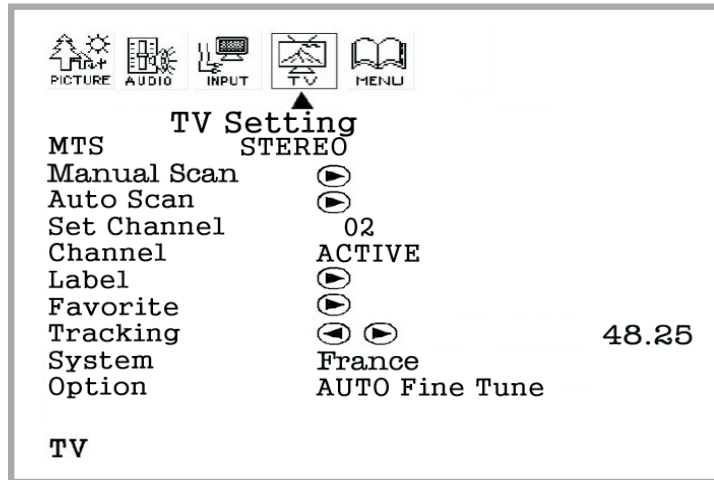

Refer to table for brief description of each option.

MTS:	STEREO/MONO/DUAL1/ DUAL2 options available
Manual Scan:	Scan for channels manually
Auto Scan:	Scan for channels automatically
Set Channel:	Select channel for setting
Channel:	Perform edit on channel
Label:	Channel labeling edit
Favorite:	Favorite channel set-ups available
Tracking:	Perform tracking for finer pictures
System:	TV regional settings
Option:	IRC, HRC, Auto FineTune options available

MANUAL SCAN :

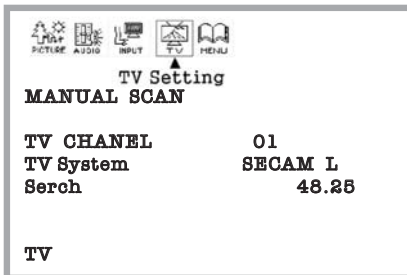

LABEL :



FAVORITE :

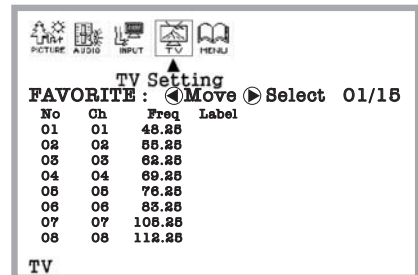

Refer to table for brief description of each option.

MANUAL SCAN:

TV Channel:	Select channel
TV System:	Select system
Search:	Select frequency

LABEL:

Select letters to rename channel labelings, then select SAVE&EXIT to confirm or EXIT to cancel changes.

FAVORITE:

No:	Favorite channel No.
Ch:	Channel number
Freq:	Channel frequency
Label:	Channel labeling

OSD Settings: TV Setting

Press TV/DVD button to ensure remote is in TV mode (see "Remote Control of TV and DVD").

MTS, option sets the audio mode (STEREO or MONO)

1. Press the MENU button on the remote.
2. Select the TV menu with the LEFT / RIGHT arrow keys on the remote.
3. Select MTS with the UP / DOWN arrow keys on the remote.
4. Use the LEFT / RIGHT arrow keys on the remote to select STEREO or MONO.

MANUAL SCAN, to tune channels manually

1. Press the MENU button on the remote.
2. Select the TV menu with the LEFT / RIGHT arrow keys on the remote.
3. Select MANUAL SCAN with the DOWN arrow, then press RIGHT arrow on the remote.
4. TV channel is highlighted, select the programme Number you want to tune with the LEFT / RIGHT keys on the remote.
5. Press the DOWN arrow key and make sure PAL I is selected (UK) using the remote arrow keys.
6. Press DOWN key to select SEARCH and then press the LEFT / RIGHT keys to search.
7. If the channel found is the wrong one, resume tuning with the remote RIGHT / LEFT keys. Repeat until the required channel is found.
8. Repeat steps 4 to 9 for each of the channels you want to tune.
9. When you have tuned in your channels you can EXIT the tune menu by pressing the MENU button on the remote three times.

Note: Please check that the SYSTEM setting is set to UK before tuning for the pictures to look correct.

AUTO SCAN, to tune channels automatically

1. Press the MENU button on the remote.
2. Select the TV menu with the LEFT / RIGHT arrow keys on the remote.
3. Select AUTO SCAN with the DOWN arrow, then press RIGHT arrow on the remote.
4. Tuning will start and the channels found will be stored sequentially. E.G. the first channel found will be stored as programme 1, the second will be programme 2 ETC.
5. When all the available channels have been found you will be dropped into the FAVORITE menu where you will need to Sort and Label the channels.
6. See the section on favorite

SET CHANNEL, channel skip

1. Press the MENU button on the remote.
2. Select the TV menu with the LEFT / RIGHT arrow keys on the remote.
3. Select SET CHANNEL with the DOWN arrow key on the remote.
4. Select the channel you want to Skip / UN-Skip with the remote LEFT / RIGHT buttons.
5. Select CHANNEL with the DOWN arrow key and with LEFT / RIGHT keys set ACTIVE(UN-Skipped) or ERASED (Skipped).
6. A Skipped Programme will not be able to be accessed by the channel step buttons on the remote or TV but can be selected by the number buttons on the remote.
7. To exit the menu, press the MENU button twice.

OSD Settings: TV Setting

Press TV/DVD button to ensure remote is in TV mode (see "Remote Control of TV and DVD").

LABEL, re-name programmes

1. Press the MENU button on the remote.
2. Select the TV menu with the LEFT / RIGHT arrow keys on the remote.
3. Select SET CHANNEL with the DOWN arrow key on the remote.
4. Select the channel number you want to NAME with the remote LEFT / RIGHT buttons.
5. Select LABEL with the DOWN arrow key and press RIGHT arrow key to enter this option.
6. Use the LEFT / RIGHT keys to highlight the character you require then press the MENU key to enter the character into the channel name displayed at the top left of the screen.
7. When you have finished naming the channels use the DOWN arrow to highlight the sub menu at the bottom of the screen SAVE & EXIT then press the MENU button to memorize and exit.

FAVORITE, Sorting channel order

1. Press the MENU button on the remote.
2. Select the TV menu with the LEFT / RIGHT arrow keys on the remote.
3. Select FAVORITE with the DOWN arrow key on the remote then press RIGHT arrow to enter.
- 4 Use the UP / DOWN keys on the remote to select the channel you want to sort to another position.
5. Press the RIGHT arrow key and "MODIFY" will flash in the top right of the screen.
6. Use the UP / DOWN keys to move the channel to the required position.
7. Press the LEFT arrow key to memorize the current position of the channel you have just moved.
8. Repeat steps 4 to 7 until all the channels are in the order that you require.
9. To exit press the MENU key on the remote 3 times.

TRACKING, Fine tuning channels

1. Press the MENU button on the remote.
2. Select the TV menu with the LEFT / RIGHT arrow keys on the remote.
3. Select TRACKING with the DOWN arrow key on the remote then press RIGHT / LEFT keys to fine-tune the current programme displayed on the screen.
4. Exit the menu by pressing the MENU key twice.

SYSTEM, Setting the transmission System

1. Press the MENU button on the remote.
2. Select the TV menu with the LEFT / RIGHT arrow keys on the remote.
3. Select TRACKING with the DOWN arrow key on the remote then press RIGHT / LEFT keys to select UK from the available options.
4. Exit the menu by pressing the MENU key twice.

OPTION, Automatic frequency control

1. Press the MENU button on the remote.
2. Select the TV menu with the LEFT / RIGHT arrow keys on the remote.
3. Select OPTION with the DOWN arrow key on the remote then press RIGHT / LEFT keys to select NORMAL or AUTO fine-tune. Auto is recommended.
4. Exit the menu by pressing the MENU key twice.

NOTE:

When navigating the Menus you can use the controls on the TV, the Channel buttons can be used as UP / DOWN (select option) and the Volume buttons can be used as the LEFT / RIGHT(alter value).

DVD Operation and Settings

BASIC OPERATIONS

Inserting and Ejecting DVD Discs

- 1) Press TV/DVD button to ensure remote is in TV mode :
"TV RC" appears on-screen. (See "Remote Control of TV and DVD".)
- 2) Select DVD picture by pressing the AV button once or by using the INPUT SELECT menu.
- 3) Press the TV/DVD button until "DVD RC" appears in the top left of the screen.
The remote is now in DVD mode.
- 4) Insert the disc into the disc slot (make sure the label side faces backwards).
Auto-play function starts as soon as the disc is inserted.
- 5) Press  to eject the disc.

Play/Pause :

Press the Play/Pause button to toggle between PLAY and PAUSE modes..



Stop :

Press the STOP button to stop disc playback.

Picture Scan :

- 1) Press the LEFT/RIGHT arrow keys to scan through the disc quickly.
- 2) When the button is pressed again, the scanning speed increases until the maximum scanning speed is reached.
Press play to resume playing the Disc.

Skipping Chapters :

Press the LEFT or RIGHT arrow keys   to skip to the previous or next chapters.

Title Menu

If the current title contains a title menu, press the **TITLE** button to access the title menu after a short pause.

DVD OSD Menu

DVD OSD Menu Descriptions

- 1) To access the DVD OSD menu, press the TV/DVD button.
- 2) Press the DVD SETUP button.
There are six option icons available across the top of the screen.
- 3) Press the LEFT and RIGHT arrow keys (left / right of the MENU button) to select the available options.
- 4) Press the UP and DOWN arrow keys (above / below the MENU button) to select the available options.
- 5) Press the ENTER button to confirm the selected option.
- 6) Press the Left arrow key until you re-enter the main choices across the top of the screen.

(1) General Set-up Page

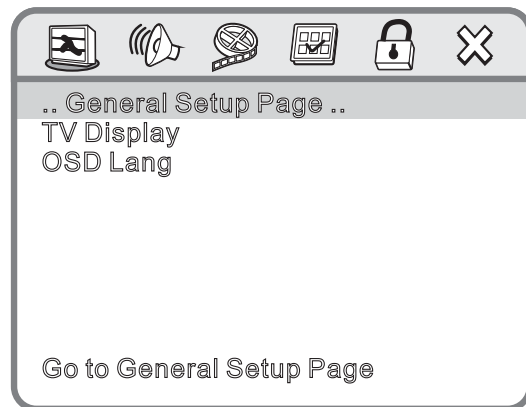

- TV Display Three options are available:
 - normal / PS : 4:3
 - normal / LB: fake 16:9
 - wide : proper 16:9

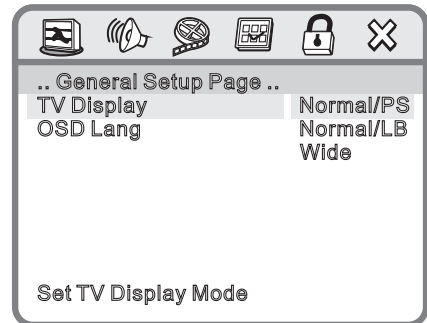

- OSD Languages Language menu options: seven languages available

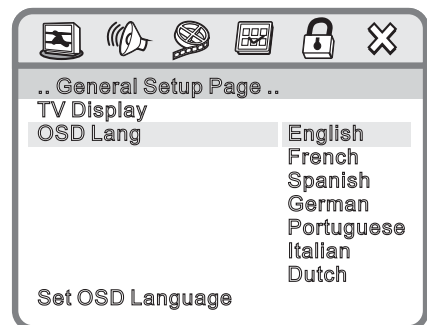

DVD OSD Menu

(2) AUDIO SET-UP PAGE:

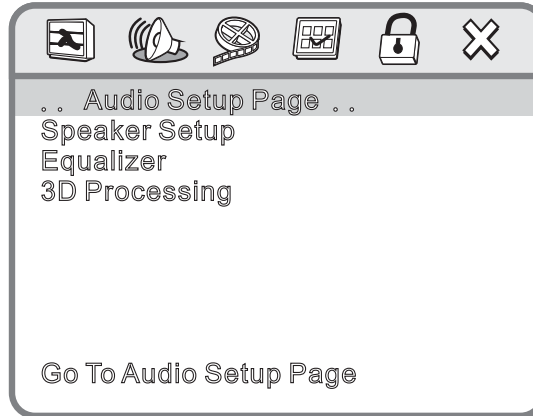

● Speaker Set-up Downmix has three settings:

- LT/RT: Left Total/ Right Total Sound
- Stereo: Stereophonic Sound
- V SURR: Virtual Surround Sound

NOTE:

LT = Left channel sound from both speakers.

RT = Right channel sound from both speakers.

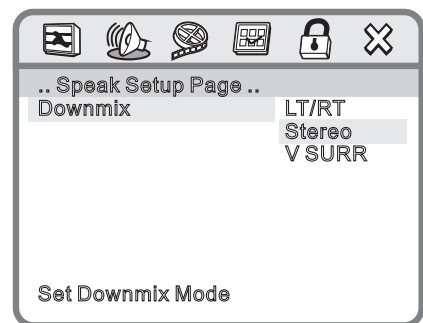

● Equalizer

There are eight types of preset equalizers to choose from: (None, Rock, Pop.....)

NOTE:

The Equalizer settings alter the characteristics of the sound, choose the setting that sounds best to you.

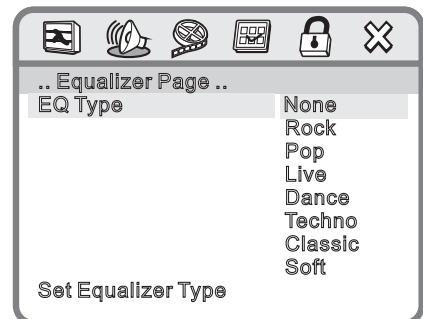

● 3D Processing This option allows the user to select its reverberation mode amongst 8 possible choices: (Off, Concert, Living room, Hall.....)

NOTE:

The Reverb mode adds various effects giving the impression of being in a church or in a concert hall ETC, default setting is OFF.

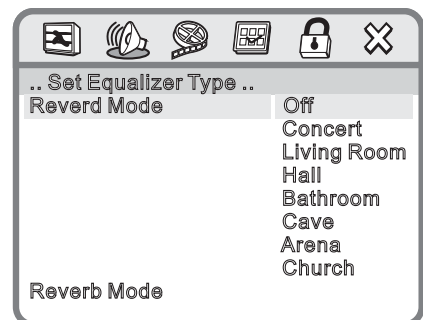

DVD OSD Menu

(3) VIDEO SET-UP

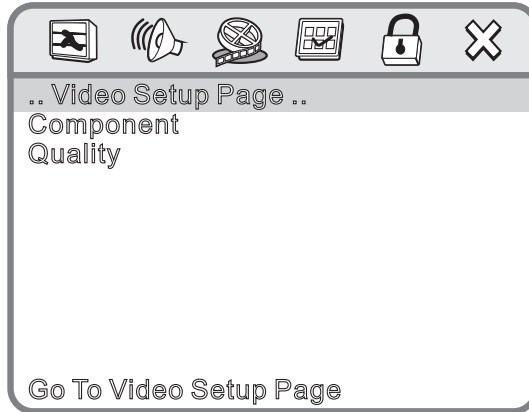

- **Component** The user can choose to apply component video (OFF), output YUV signal (YUV) or output RGB signal (RGB).
- **Quality** Select Quality to access the video quality set-up menu. This menu will allow you to choose amongst seven options and modify the quality of the video (sharpness, brightness, contrast, gamma, hue, saturation, luma delay).

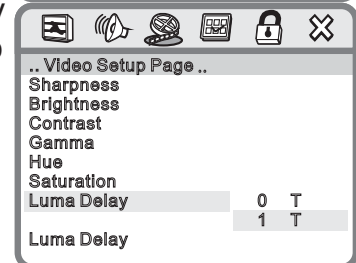
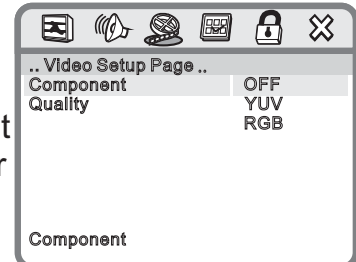

(4) PREFERENCES

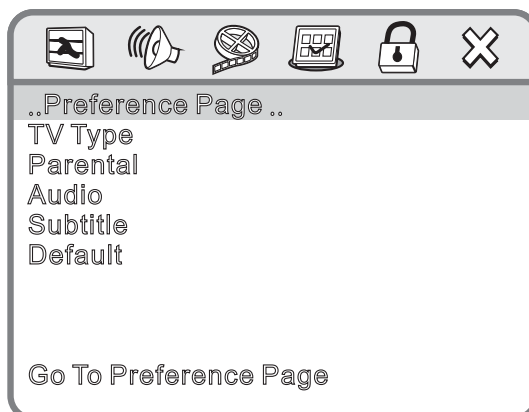

- **TV Type** The user can choose the TV system amongst the three available (PAL, MULTI and NTSC).

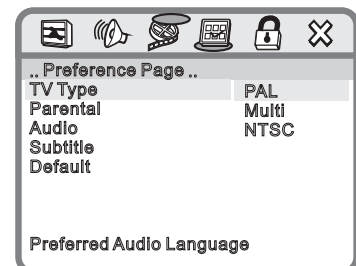

- **Parental**
The user may want to use the parental control option for the DVD player to limit its access. The user first chooses amongst 8 different categories (KID SAF, G, etc.). Then press ENTER to see the password box appear. Finally, press the TV/DVD button and then the T.T. Button before entering the pass number with the number buttons on the remote which will restrict access to the category of DVD selected.

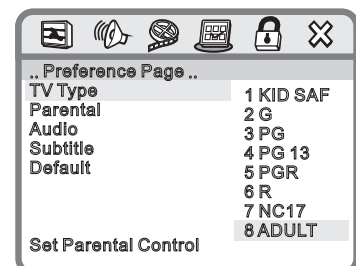

DVD OSD Menu

- **Audio** Options are available in 8 different languages (English, French, Spanish, Chinese, Japanese, Korean, Russian and Thai). Please note that availability depends on each DVD original setting.

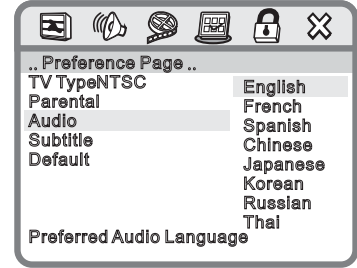

- **Subtitle** Subtitles are available in 8 different languages (English, French, Spanish, Chinese, Japanese, Korean, Russian and Thai). Please note that availability depends on each DVD original setting.

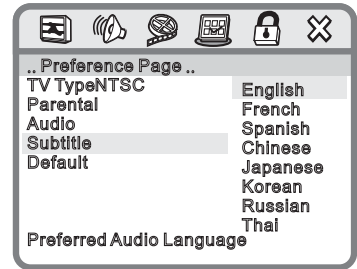

- **Default** Reset for factory settings.

(5) PASSWORD SET-UP PAGE

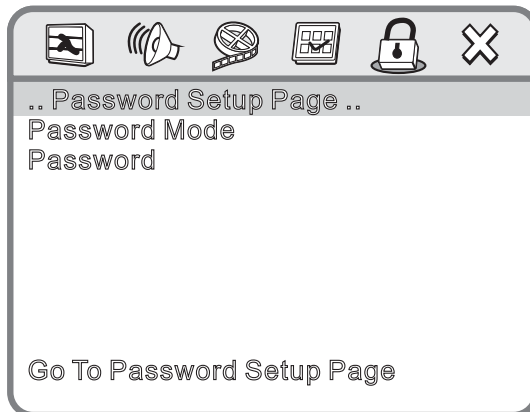

- **Password Mode** Enter a four-digit password into the blank box before changing the On/Off setting. The system default password is 3800.

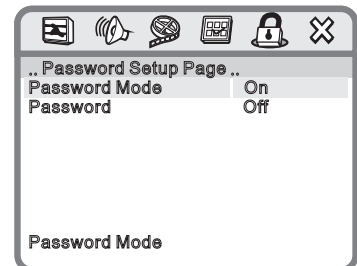

- **Password** Select Change to change password. Then enter a new four-digit password, then enter the former password, and finally reconfirm the former password. Select OK to confirm the new password setting. The system default password is 3800.

DVD OSD Menu

(6) EXIT

Exit the DVD set-up menu.

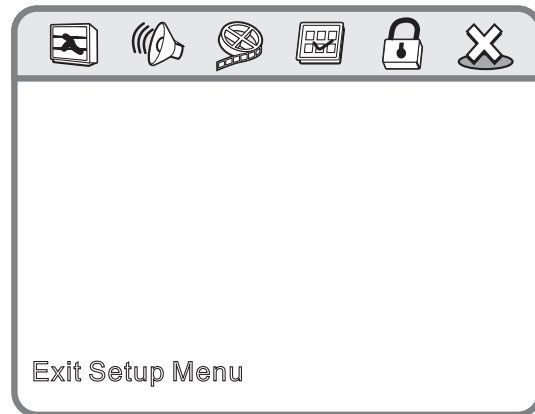

Teletext Instructions

Teletext is a free information system that displays text on your TV. It is noteworthy that not all TV stations provide this service. The time is displayed on the top right corner of the screen.

Using Teletext

Press the “T.T.” button of the remote control. You will directly go into the list of contents, which is displayed on the TV screen.

Selecting a page of Teletext

1. According to the list of contents, press the appropriate number buttons. The selected page number is displayed in the top left corner of the screen. The Teletext system searches for the desired page until it is located.
2. To move the Teletext forward/backward at one page at a time, respectively press the LEFT and RIGHT arrow keys of the remote control.

Using the Teletext menu of the remote control

1. To select the list of content, press the “INDEX” button.
2. To modify the size of characters displayed on the screen, press “SIZE” button.
3. When a Teletext page contains more information than the screen can contain, the rest of the information will be displayed after a period of time. Press the “HOLD” button to stop the automatic page change. Press the “HOLD” button again to resume the automatic page change. When HOLD is active the hold icon will appear the top left of the screen
4. To reveal concealed information such as answers on a quiz, press the “REVEAL” button. Press it again to conceal the information.
5. To have Teletext information superimposed over the TV programme, press the “MIX” button. Press the “MIX” button again to return to the basic Teletext format (i.e. Black background).
6. To select a subcode page, first press the “SUBCODE” button on the appropriate page then press the appropriate digit buttons to require the subcode page. Subcode pages are subsections of teletext pages which can only be displayed one section at a time.
7. To use fast test, press the appropriate colored buttons (red, green, yellow, blue) to access the required page quickly. To facilitate the use of Teletext, some sections and topics may have particular colors.
8. To exit Teletext, press the “T.T.” Button on the remote again.

Troubleshooting

Symptoms	Check Item
TV will not turn on / no power:	<ul style="list-style-type: none"> ● Check power adapter and cord is connected properly. ● Check power adapter and cord if they have been damaged. ● Check if outlet is working. ● Unplug TV for a few minutes and turn it on again.
Remote control failure:	<ul style="list-style-type: none"> ● Check batteries are not dead or installed incorrectly. ● Check if there are obstructions between remote and TV sensor. ● Aim remote control at IR receiver window from 2 inches away. ● If failure results from electrical interferences, lighting, or static, disconnect the TV power cord for 10 seconds before reinstalling it. Restart your TV.
Buttons on TV or Remote do not work	<ul style="list-style-type: none"> ● Possible Micro Processor crash disconnect the TV from the mains for a few minutes then re connect and try again.
No picture and sound:	<ul style="list-style-type: none"> ● Check if in stand-by mode. ● Verify all connections are firmly attached. ● Press "AV" key to cycle to the correct input source.
Picture with NO sound:	<ul style="list-style-type: none"> ● Check volume or mute buttons. ● Verify all connections are firmly attached. ● Video and audio plugs connected to different sources.
Sound with NO picture:	<ul style="list-style-type: none"> ● Check brightness and contrast levels.
Poor colour tone or NO color:	<ul style="list-style-type: none"> ● Adjust picture settings. ● Check reception and the antenna. ● Make sure S-video terminal has nothing connected. ● Check memory setting.
	<ul style="list-style-type: none"> ● Check color or picture setting. ● Check if program is in correct channel. ● Check possible outside interferences.
No reception from Cable:	<ul style="list-style-type: none"> ● Check if cable is connected properly. ● Check if channels are selected properly. ● Check if cable company is experiencing technical difficulties.
No picture when playing DVD:	<ul style="list-style-type: none"> ● Check the DVD disc is not damaged, clean the disc, check for fingerprints ● If DVD player supports progressive scan, switch the DVD player into interlaced mode.
Picture is blurry or snowy:	<ul style="list-style-type: none"> ● Check other channels. Problem may be an isolated incidence. ● If using outdoor antenna, please check connection or interference. ● Check accessories components (VCR, DVD, etc). ● RF signal may be too slow.

Troubleshooting

<p>Picture too dark:</p>	<ul style="list-style-type: none"> ● Check brightness level. ● Check contrast level. ● Adjust saturation or hue levels. ● Check LCD monitor for possible damage.
<p>Picture is not sharp or the picture shakes:</p>	<ul style="list-style-type: none"> ● The reception may be weak. ● The quality of the broadcast may also be bad. ● Adjust the antenna to face the correct direction. ● Make sure outside antenna has not been disconnected.
<p>Picture has ghosts or multiple pictures:</p>	<ul style="list-style-type: none"> ● Results of two signals, try adjusting antenna direction or location. ● Broadcast waves may be reflected from adjacent mountains or buildings. ● Video and Audio plugs connected to different sources.
<p>Picture is spotted or stripes appear:</p>	<ul style="list-style-type: none"> ● There may be interferences from cars, trains, high-voltage lines, neo lights, etc. ● There may be interference between the antenna cable and power cable. Try positioning them further apart. ● There may be interferences from other devices such as radiors or cellular phones ● Check reception and the antenna .
<p>Smearing on fast moving objects:</p>	<ul style="list-style-type: none"> ● In low temperature, the picture may leave trails or appear slightly delayed. This is not a malfunction, the unit will return to normal.

Disposal



Waste electrical and electronic products must not be disposed of with household waste. Please refer to the retailer from whom you purchased this item for disposal instructions. Batteries and packaging materials should be recycled using local facilities.

We have made every effort to ensure these instructions are as accurate as possible, however we apologise for any inconvenience caused by minor inconsistencies which may occur as a result of product improvement and development.