

**DIGITAL
TERRESTRIAL
RECEIVER**

GUDSTB2000

ENGLISH

GERMUNDIG

IMPORTANT SAFETY INSTRUCTIONS

WARNING

To reduce the risk of fire or electric shock, do not expose this equipment to rain or moisture.



CAUTION

**RISK OF ELECTRIC SHOCK
DO NOT OPEN**



**CAUTION: TO AVOID THE RISK OF ELECTRIC SHOCK,
DO NOT REMOVE COVER (OR BACK).
NO USER-SERVICEABLE PARTS INSIDE.
REFER SERVICING TO QUALIFIED SERVICE PERSONNEL.**



This symbol is intended to alert the user to avoid the risk of electric shock, do not disassemble this equipment by anyone except a qualified service personnel.



This symbol is intended to alert the user to the presence of important operating and maintenance instructions in the literature accompanying the appliance.

Thank you for purchasing this product. Please check carefully in the box for the following parts:

1. 1 X GUDSTB2000STB
2. 1 X Remote control
3. 2 x AAABatteries
4. 1 X ScartCable
5. 1 X RFloop cable
6. Instruction manual (you are reading it)
7. 12VDC Mains adaptor

WARNINGS

Unqualified attempts to repair this unit are not allowed. Refer repairs to this unit to a qualified technician only.

Do not disassemble this unit. There are dangerous-voltage parts inside that may cause electric shock even after power is disconnected.

Store your unit in a clean, dry environment, Unplug the unit immediately it gets wet, and consult your servicing technician.

Always unplug the unit before cleaning it. Wipe dust off the cabinet of the unit with clean & dry & soft cloth. Apply non-ammonia cleansing lotion onto the cloth, not directly onto the screen.

Do not place heavy objects on top of the unit.

Avoid exposing your unit directly to sunlight or other heat sources.

Put your unit in a well-ventilated area away from high humidity.

Do not expose this unit to rain or moisture, dripping or splashing.

Safety Tips

If smoke, abnormal noise or odour comes out of your unit, unplug from the mains supply immediately and call your dealer.

Never try to repair the your unit on your own. Always call your dealer for repairs.

Note

This user's manual contains for-reference-only graphics and information that are subject to change without notice.

WEEE:

This appliance is labelled in accordance with European Directive 2002/96/EG concerning used electrical and electronic appliances(waste electrical and electronic equipment - WEEE). The guideline determines the framework for the return and recycling of used appliances as applicable throughout the EU.

CONTENTS

SAFETY INFORMATION

5-7

- 5 Front panel
- 5 Rear panel
- 6 Remote control
- 7 Remote control functions

8

- 8 **SYSTEM CONNECTION**
- 8 General
- 8 Connecting to the TV with SCART
- 8 Connecting a video recorder or DVD recorder
- 8 Connecting a HiFi system

9

- 9 **GETTING STARTED**
- 9 Switching on for the first time
- 9 Automatic channel scan
- 9 Manual channel scan

10

- 10 **OPERATION**
- 10 Changing channels
- 10 Setting a reminder

11

- 11 **CHANNEL LIST**
- 11 Channel list

12

- 12 **FAVOURITE LIST**
- 12 Favourite list

13-14

- 13 **SYSTEM SETTING**
- 13 A/v setting
- 13 First time installation
- 13 System info
- 14 Change Pin Code
- 14 Software update

15

TROUBLESHOOTING

16

SPECIFICATION

INTRODUCTION

Front Panel



Rear Panel

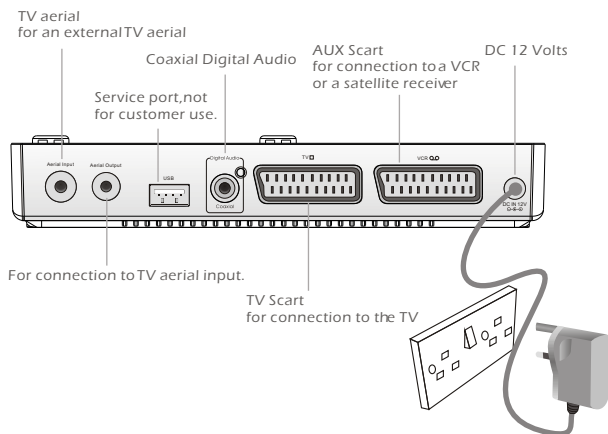

NOTE: Connect the 12 Volt DC adaptor cable to the DC In socket. Connect the adaptor to a 230VAC mains supply.

INTRODUCTION

Remote Control

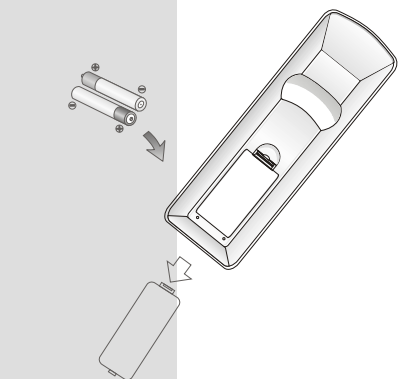

- Remove the battery compartment cover.
- Load two AAA (UM-4 or R03) batteries into the battery compartment.
- Make sure that the batteries have been inserted in the correct polarities matching to the symbols +, - marked in the battery compartment. Close the battery compartment cover.
- When replacing batteries, replace both batteries. Do not mix new and used batteries operating together, otherwise, the operation lifetime will be much shorter than normal.
- Remove the batteries if the unit will not be used for a prolonged period of time.



Within approximately
6 metres (20 feet)

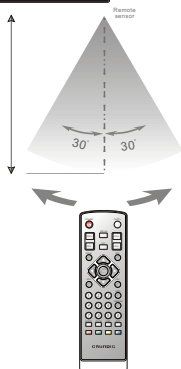

The remote control transmits a directional infrared beam. Be sure to aim the remote control directly at the infrared sensor of the unit during operation.

If the sensor has been covered or there is a large object between the remote control and the sensor, the sensor will not respond.

The sensor may not be able to receive the remote signal when it is exposed to direct sunlight or a strong artificial light (fluorescent or strobe light). In this case, change the direction of the light or reposition the unit to avoid direct lighting.

BE ENVIRONMENTALLY FRIENDLY

Do not dispose batteries as normal rubbish.
Be environmentally friendly, dispose batteries following the
Government's regulation.

INTRODUCTION

Remote Control Functions

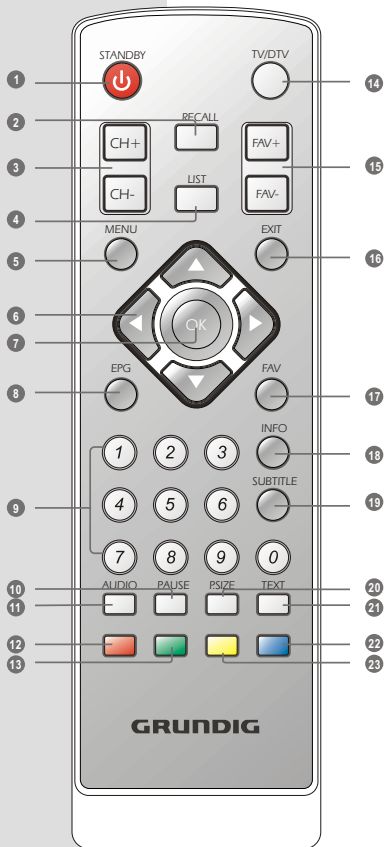

Note 1:

The AUDIO button on the remote can be used to switch on the AUDIO DESCRIPTION (AD) that are broadcast on some Programmes. As not all programmes will transmit AD you will need to check with your TV programme guide that it is being transmitted. Pressing the AUDIO button repeatedly will toggle ENGLISH (normal audio) and ENGLISH AD (Audio description). When AD is selected and AD is being transmitted then normal audio is replaced by a narrative of what is being shown on the TV.

- 1 Power On/Standby (Switch the STB ON/STANDBY mode)
- 2 Recall (Reverts to previous channel)
- 3 Channel up/down
- 4 LIST Open the channel list
- 5 Menu (Open up menu)
- 6 Cursor (to select sub-menu from the main menu)
- 7 OK button (Press to enter.)
- 8 EPG (Open Electronic Programme Guide)
- 9 Numeric entry (Enter numeric values and to select the channel directly by entering its number)
- 10 PAUSE (Pause the current picture)
- 11 AUDIO (full description of operation is shown in note 1 below)
- 12 Red Button (For interactive use and favourite list switch)
- 13 Green Button (For interactive use)
- 14 TV/DTV (Switches between TV tuner and DTV)
- 15 FAV+ /FAV- (switch up/down channels in the current favourites list)
- 16 Exit (Exit from menu)
- 17 FAV (Open up Favourite list)
- 18 INFO (Display the current channel information)
- 19 SUBTITLE (On/Off Subtitle)
- 20 P.SIZE (Change the TV picture aspect)
- 21 TEXT
- 22 Blue Button (for interactive use and used to delete a channel in the channel list menu.)
- 23 Yellow Button (For interactive use)

SYSTEM CONNECTION

General

There are many different types of equipment that you can connect to the STB. In this manual you will see some of the most common ways to connect your equipment.

Note: Scart and RF cables are supplied for basic connections to your TV. Other cables shown are not supplied and may be purchased from most HiFi/ TV Retail outlets.

Connecting to TV using Scart

NOTE:

Disconnect the TV aerial from your TV and reconnect it to the aerial in socket on your box. Connect the supplied RF loop cable to the TV out socket on the box. Connect the other end to the aerial in socket on your TV.

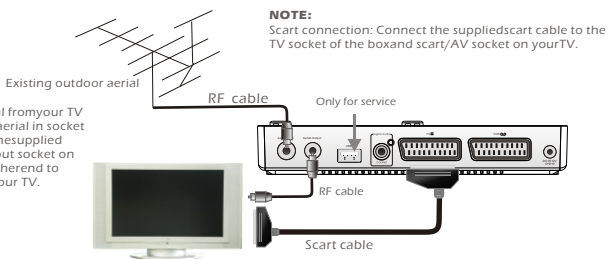

Connecting a Video Recorder or DVD Recorder

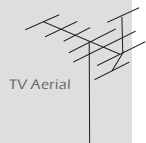

NOTE:

1 X Scart cable and RF cable is supplied. Other cables shown are not supplied. Use the existing cables that would normally be supplied by your original VCR setup.

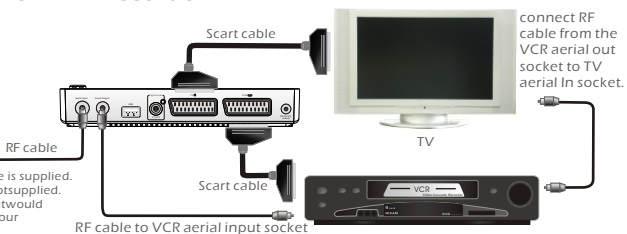

Connecting a HiFi system (with digital audio input)

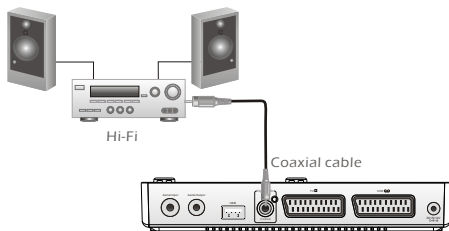

GETTING STARTED

Switching on for the First Time

Turn on your TV set and select the corresponding AV input (with the AV key, or similar, on the television remote control).

Turn on the main power supply to the STB, the indicator on the front of the unit will turn red and then blue. In standby mode, the indicator light will be red. In working mode, the indicator light will be blue.





- If you use the STB for the first time or have deleted all channels in the STB, a "TV Setting" menu displays.
- Press "LEFT" or "RIGHT" cursor button to choose either "16:9" or "4:3" according to the TV shape you have..
- Make sure that the TV aerial is connected to the unit then, press "OK" button to continue installation.
- Press "LEFT" or "RIGHT" cursor button to highlight "confirm".
- Press "OK" button to continue. "Scan Progress" menu will appear and list the channels as they are found. A bar appears below the listing panel that indicates the progress of the channel search.
- When all channels have been found, the channel at the top of the list will show on the TV.

Automatic Channel Scan

use this tuning method when you have moved location or need to add any new channels that will appear from time to time.





- ① Press the "MENU" button  to enter the main menu of the STB.
- ② Press the "UP" or "DOWN" cursor button to select . And press the "OK" button to enter the Channel Search menu.
- ③ Highlight the "Search Type" and press "LEFT" or "RIGHT" cursor button to select "Auto scan".
- ④ Press the "OK" button to start searching.
- ⑤ Press "EXIT" button  to quit.

Manual Channel Scan

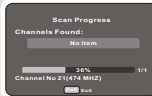
If you know that a new channel is being broadcast and want to add this channel and know what frequency it is being transmitted on then use this quick method of adding a new channel. Otherwise use the Automatic method shown above.



- ① Press the "MENU" button  to enter the main menu of the STB.
- ② Press the "UP" or "DOWN" cursor button to select . And press the "OK" button to enter the Channel Search menu.
- ③ Highlight the "Search Type" and press "LEFT" or "RIGHT" cursor button to select "Manual scan".
- ④ Press "DOWN" cursor button to select "Channel No" section, and enter desired Channel Number using numeric button.
- ⑤ Press the "OK" button to start searching.
- ⑥ Press "EXIT" button  to quit.



OPERATION

Changing Channels

There are four ways of channel selection -stepping through the channel list, selection by number,from the on-screen channel list, and using the EPG



- ① **Stepping through the channel list:**
Press the "UP" or "DOWN" cursor button to browse up and browse down the available channels.
- ② **Selection by number:**
Enter the complete channel number directly by remote control to select desired channel.
- ③ **Selection by on-screen channel list:**
You can also select the desired channel directly from on-screen channel list. This is displayed using the STB's main menu. Please See "CHANNEL LIST" in this manual for the operation detail.
- ④ **Selection by setting a Reminder in the EPG (Electronic Programme Guide):**
You can also select the desired channel directly from EPG. This is displayed by pressing the "EPG" button on the remote control. The EPG provides a brief description of the programme on the currently selected channel and lists the current channels.



- Press the "EPG" button  to enter the Channel Schedule .
- Press the "CH+" or "CH-" cursor button  to select the desired channel, the screen switches to the programme on the currently selected channel.
- Press "EXIT" button  to quit the EPG and view the channel on full screen.

Setting a Reminder

From the EPG ,you can change channels,check programme information , access one-week programme schedule which details the times and programmes for the next seven days and set a reminder for 8 programmes to automatically view at the preset time. .

- ① Press the "EPG" button  to enter the Channel Schedule.
- ② Press "UP" or "DOWN" cursor button to preview the current programme on the selected channel, and check the current programme information.
- ③ Press "LEFT" or "RIGHT" cursor button to navigate the program lists in next seven days.
- ④ Press "UP" or "DOWN" cursor button to highlight the desired programme.
- ⑤ Press "OK" button to add the reminder, then  will appear alongside the selected programme. When the reminder programme is about to start, a reminder window will appear.
- ⑥ Press "EXIT" button  to quit the channel schedule.

NOTE

- The current broadcasting programme can not be set to the reminder event.

CHANNEL LIST

Channel List

The Channel List presents a list of all channels found during the channel search. From the Channel List you can watch and listen to the selected channels, delete them from the list, edit the name of the channel, set a password to access the channel.



NOTE

- The picture frame will be blank if a radio channel is selected.



① Press "MENU" button  to enter the main menu of the STB.

② Press "UP" or "DOWN" cursor button to highlight .

③ Press "OK" button to enter Channel List menu.

④ Press "UP" or "DOWN" cursor button to highlight a channel.

⑤ Press "OK" button to preview the selected channel.

⑥ Press "EXIT" button  to quit the channel list menu and view the channel on full screen.

Delete a channel:

① Enter the channel list menu, press "UP" or "DOWN" cursor button to select a channel.

② Press the YELLOW button to delete the selected channel. The channel is permanently removed and cannot be restored by scanning the channels..

Lock/Unlock a channel:

① Enter the channel list menu, press "UP" or "DOWN" cursor button to select your desired channel.

② Press the BLUE button, you are asked to enter pin code.

③ Enter a correct pincode using the numeric buttons, press "OK" button to confirm. (the default pin code is 888888)

④ Then a lock symbol  displays alongside the selected channel, it shows that the channel has been locked.

⑤ Repeat ①②③ to remove the lock symbol.

⑥ Press "EXIT" button  to quit the channel list.



FAVOURITE LIST

Favourite List

This menu allows you to store a list of your favourite channels. So that you can access them more easily. There are five favourite lists to set, each family member can have their own favourite list.

Adding channels to Favourite list:





- 1 Press the "MENU" button  to enter the main menu of the STB.
- 2 Press the "UP" or "DOWN" cursor button to select .
- 3 Press the "OK" button to enter the favourite list menu.
- 4 Press the RED button to switch the desired favourite list.



- 5 Press the "UP" or "DOWN" cursor button to highlight desired channel in the selected favourite list.
- 6 Press OK button to add the selected channel to the favourite list.
- 7 Press "EXIT" button  to quit.



Remove favourite channels from favourite list:



- 1 Press the "MENU" button  to enter the main menu of the STB.
- 2 Press the "UP" or "DOWN" cursor button to select .
- 3 Press the "OK" button to enter the favourite list menu.
- 4 Press the RED button to switch the desired favourite list.
- 5 Press the "UP" or "DOWN" cursor button to highlight the favourite channel in the favourite list.
- 6 Press OK button to remove the channel from the favourite list.
- 7 Press "EXIT" button  to quit.

Accessing the favourites channels:



- 1 Press the "FAV" button  to enter the "FAVOURITELIST".
- 2 Press the RED button to switch desired favourite list.
- 3 Press "UP" or "DOWN" cursor button to select the favourite channel in the selected favourite list.
- 4 Press the "OK" button to view the favourite channel on full screen.
- 5 Press the "Exit" button  to quit.





SYSTEM SETTING

Many aspects of your STB can be set to reflect your circumstances and preference. The SETTINGS menu screen is accessed from main menu.

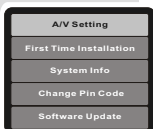
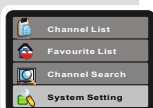
A/V Setting

This menu allows the users to set TV shape, Video Output and OSD Transparency.



- ① Press the "MENU" button  to enter the main menu of the STB.
- ② Press the "UP" or "DOWN" cursor button to select .
- ③ Press the "OK" button to enter the sub-menu.
- ④ Press "UP" or "DOWN" cursor button to select "A/V Setting" and Press "OK" button to enter its sub-menu.
- ⑤ Press "UP" or "DOWN" button to select the desired item and press "LEFT" or "RIGHT" cursor button to select desired setting.
- ⑥ Press "MENU" button  to return the upper menu. Press "EXIT" button  to quit.

TV Shape: 4:3 OSD Transparency: 0%~ 100%
16:9
Video Output: CVBS
RGB

First Time Installation

To delete all existing channels in the STB, and reset the STB to factory default setting, this is also useful if you move to another area and need to rescan all the channels.

- ① Enter the system setting menu, press "UP" or "DOWN" cursor button to highlight the First Time Installation.
- ② Press "OK" button to confirm, a confirmation window appears.
- ③ Press "LEFT" or "RIGHT" cursor button to highlight "Confirm" icon, press "OK" button to start first time installation.
- ④ Highlight "Exit" icon, press "OK" button to cancel the first time installation.



System Info

This menu will show the software version and hardware serial ID of the STB. There are no user settings that can be changed in this menu.

- ① Enter the system setting menu, press "UP" or "DOWN" cursor button to highlight the System Info menu.
- ② Press "OK" button to open up the information window, and you can view the software and hardware version of the STB.



SYSTEM SETTING

Change Pin Code

This menu allows users to change pin code.

- ① Enter the system setting menu, press "UP" or "DOWN" cursor button to highlight the Change Pin Code menu.
- ② Press "OK" button to enter the sub-menu.
- ③ Enter the old pin code using the numeric buttons (Default pin code is 888888).
- ④ Press "UP" or "DOWN" cursor button to select "New Pin Code" and enter six new numbers with numeric buttons (0~9).
- ⑤ Press "UP" or "DOWN" cursor button to select "Enter Again", and enter the new pin code again with numeric buttons (0~9).
- ⑥ Press "OK" button to confirm the changed pin code.

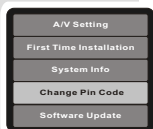

Software Update

This menu allows users to update the software version.

- ① Enter the system setting menu, press "UP" or "DOWN" cursor button to highlight the Software Update menu.
- ② Press "OK" button to enter the sub-menu.



Auto Mode:

- ① Enter the software update menu, press "UP" or "DOWN" cursor button to highlight Auto Mode.
- ② Press "OK" button to enter Auto Mode menu.
- ③ Press "LEFT" or "RIGHT" cursor button to set the status to ON.
- ④ Press "UP" or "DOWN" cursor button to select Start time item. Use the numeric button to enter the time in HH:MM mode.
- ⑤ Press "OK" button to save the setting and quit, then the system will start auto update at the set time.



Manual Mode:

- ① Enter the software update menu, press "UP" or "DOWN" cursor button to highlight Manual Mode.
- ② Press "OK" button to enter Manual Mode menu.
- ③ Press "LEFT" or "RIGHT" cursor button to highlight "Scan" icon.
- ④ Press "OK" button to start updating.
- ⑤ Press "Exit" button to quit.

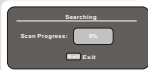
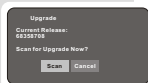

TROUBLESHOOTING

In some areas, the digital terrestrial signal may be weak. It is vitally important that the aerial and cable used is the latest high gain type to ensure trouble free reception. If you are in any doubt of the reception area for Free View reception call 08701 111270 or tune your existing analogue TV to BBC 1 and select Teletext on page 284. Follow the onscreen instructions to test if your aerial / location is suitable for FreeView Digital reception..

Problem	Possible cause	What to do
Standby light not lit	Mains socket is switched off	Make sure that the mains socket is working / try connecting to another mains socket in a different room.
No signal found	Aerial is disconnected Aerial is damaged/misaligned Out of digital signal area	Check aerial lead Check aerial Tune your existing analogue TV to BBC 1 teletext page 284.
No picture or sound	Scart/AV has not been selected on your TV	Press the AV button on your TV remote.
Scrambled channel message	Channel is scrambled	Select alternative channel
No response to remote control	Receiver off Handset not aimed correctly Front panel obstructed Hand set batteries exhausted	Check mains plug is connected. Aim handset at front panel Check for obstructions Replace handset batteries
Forgotten channel lock code		Re-install channels to cancel channel lock
Forgotten menu lock code		Contact help line
After moving the Digital Box to another room you find you are no longer able to receive digital reception	The aerial feed from the new aerial connection may be faulty box.	Try a direct feed from the aerial or use a different aerial connection.
You can check out if your TV aerial or location is suitable for Digital reception.	Switch on Your TV and tune to BBC 1 Analogue reception.	Select Teletext and input page 284. Follow the instructions shown.

SPECIFICATIONS

<p><u>SYSTEM RESOURCE</u></p>	<ul style="list-style-type: none"> • FLASH 2MB • SDRAM 16MB
<p><u>TUNER & CHANNEL</u></p>	<ul style="list-style-type: none"> • RF INPUT CONNECTOR x1 (IEC-TYPE, IEC169-2, FEMALE) • RF OUTPUT CONNECTOR x1 (IEC-TYPE, IEC169-2, MALE (LOOPTHROUGH)) • FREQUENCY RANGE: 470MHz ~862MHz (UHF) • SIGNAL LEVEL: -15 ~ -70 dbm
<p><u>DECODER</u></p> <ul style="list-style-type: none"> • TRANSPORT STREAM • PROFILE LEVEL • INPUT RATE • VIDEO FORMATS • AUDIO FORMAT • VIDEO OUTPUT 	<p>MPEG-2 ISO/IEC 13818</p> <p>MPEG-2 MAIN PROFILE @MAINLEVEL</p> <p>MAX. 15Mbit/s</p> <p>4:3/16:9 SWITCHABLE</p> <p>MPEG Layer I & II, 32 / 44.1 / 48KHz</p> <p>CVBS ,RGB(DEFAULT)</p>
<p><u>CONNECTION</u></p> <ul style="list-style-type: none"> • MAIN POWER CABLE • TUNER • SCART • SPDIF • DATA PORT 	<p>FIXED TYPE</p> <p>ANTENNA INPUTx1, RF OUTPUTx1</p> <p>OUTPUT for TV x1, OUTPUT for VCR X1</p> <p>COAXIAL x1</p> <p>USB SLOT x1</p>
<p><u>POWER SUPPLY</u></p> <ul style="list-style-type: none"> • INPUT VOLTAGE • POWER CONSUMPTION 	<p>DC 12V=1000mA</p> <p>MAX. 10W,STANDBY 5W</p>

NOTE

- Design and Specifications are subject to change without notice.



NOTE

© 2007.06

cecustomerservice@albapl.c.o.uk
0871 230 1777