

IMPORTANT SAFETY INSTRUCTIONS

WARNING

To reduce the risk of fire or electric shock, do not expose this equipment to rain or moisture.



CAUTION

**RISK OF ELECTRIC SHOCK
DO NOT OPEN**



**CAUTION: TO AVOID THE RISK OF ELECTRIC SHOCK,
DO NOT REMOVE COVER (OR BACK).
NO USER-SERVICEABLE PARTS INSIDE.
REFER SERVICING TO QUALIFIED SERVICE PERSONNEL.**



This symbol is intended to alert the user to avoid the risk of electric shock, do not disassemble this equipment by anyone except a qualified service personnel.



This symbol is intended to alert the user to the presence of important operating and maintenance instructions in the literature accompanying the appliance.

MAINS PLUG WIRING

Electrical Information

This appliance is fitted with a BS1363/A 13 amp plug. If it is not suitable for your supply sockets it must be removed and replaced with an appropriate plug. If the plug becomes damaged and/or needs to be replaced please follow the wiring instructions below. The plug removed must be disposed of immediately. It must not be plugged into a supply socket as this will be an electrical hazard. If the fuse needs to be replaced it must be of the same rating and ASTA approved to BS1362. If the plug is changed, a fuse of the appropriate rating must be fitted in the plug, adapter or at the distribution board. If the fuse in a moulded plug is replaced, the fuse cover must be refitted before the appliance can be used.

Wiring Instructions

The supply cable will be either 2-core or 3-core. Follow the appropriate wiring instructions given below. In both cases ensure that the outer sheath of the cable is firmly held by the cable clamp.

2- CORE

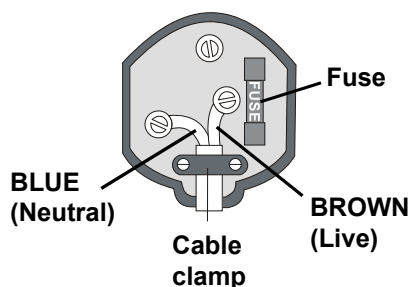

WARNING! Do not connect either wire to the earth terminal.



This symbol indicates that this 2-core appliance is Class II and does not require an earth connection.

The wire coloured blue must be connected to the terminal marked with the letter N or coloured black.

The wire coloured brown must be connected to the terminal marked with the letter L or coloured red.

3- CORE

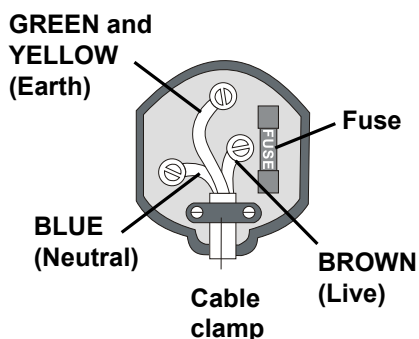

WARNING! This appliance must be earthed.

The wire coloured green and yellow must be connected to the terminal marked with the letter E, or by the earth symbol, \perp , or coloured green or green and yellow.

The wire coloured blue must be connected to the terminal marked with the letter N or coloured black.

The wire coloured brown must be connected to the terminal marked with the letter L or coloured red.

WARNINGS

- Unqualified attempts to repair this TV are not allowed. Refer repairs to this unit to a qualified technician only.
- Do not disassemble this unit. There are dangerous-voltage parts inside that may cause electric shock even after power is disconnected.
- Store your unit in a clean, dry environment, Unplug the unit immediately it gets wet, and consult your servicing technician.
- Always unplug the unit before cleaning it. Wipe dust off the cabinet of the unit with clean & dry & soft cloth. Apply non-ammonia cleansing lotion onto the cloth, not directly onto the screen.
- Do not place heavy objects on top of the unit.
- Avoid exposing your unit directly to sunlight or other heat sources.
- Put your unit in a well-ventilated area away from high humidity.
- Do not expose this TV to rain or moisture, dripping or splashing.

Safety Tips

- If smoke, abnormal noise or odour comes out of your unit, unplug from the mains supply immediately and call your dealer.
- Never try to repair the your unit on your own. Always call your dealer for repairs.

WEEE:

This appliance is labelled in accordance with European Directive 2002/96/EG concerning used electrical and electronic appliances(waste electrical and electronic equipment - WEEE). The guideline determines the framework for the return and recycling of used appliances as applicable throughout the EU.

CONTENT

PREPARATION	5
Features	5
Package Contents	6
Setting up your LCD TV.....	7
LCD TV	10
Front /Side View	10
Rear View	11
Remote Control	12
INSTALLATION	15
Connecting a TV Cable or Aerial.....	15
Basic Operation.....	15
Connecting a DVD Player	17
Connecting a VCR & a Video Camera	18
Connecting a TV Box and Satellite Receiver	19
Connecting an Audio Receiver.....	20
HDMI.....	21
USING THE FEATURES	23
Wide Screen Viewing.....	23
Using the Picture in Picture.....	25
OSD Menu Operation	27
Video	27
Audio.....	28
Setup.....	29
Preferences.....	30
Screen.....	30
USING THE DTV FEATURES	31
TROUBLESHOOTING	40
SPECIFICATIONS	41

PREPARATION

Features

Features

High Brightness / Contrast Image

Brightness: 500 cd/m² (32") / 500 cd/m² (37") / 500 cd/m² (40")

Contrast Ratio: 1200:1(32") / 1000:1(37") / 1200:1(40")

Multimedia socket

VIDEO in socket

S-VIDEO in socket

SCART 1 socket (RGB,CVBS,Y/C input;CVBS output)

SCART 2 socket (Y/C,CVBS input)

Y Pb Pr in socket

VGA in socket

HDMI 1 / HDMI 2 in socket

WSS (Wide Screen Scale) Function

This function can automatically convert and display any aspect ration (4:3 / Wide) TV broadcast signal.

Teletext Function

NICAM/ FM-Stereo Function

Auto Programme Sort (APS)

Manual search

Sleep-Timer

User selectable colour temperature settings

Built-in ATV and DTV Tuners

The built-in DTV tuner allows the reception of DVB-T broadcasting without the addition of a set-top box.

PIP/POP Function

This function allows viewing of video from two different sources simultaneously.

Package Contents

Once you open the box, make sure all of the following contents are included. If you're missing any items, please contact your dealer.



LCD TV

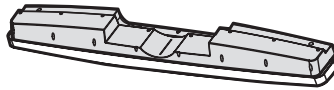

Speaker

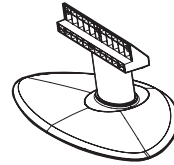

Stand



Remote control/
AAA batteries

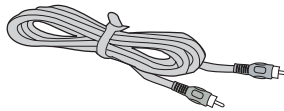

Video Cable

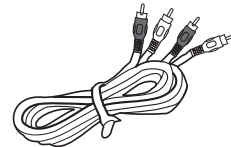

Audio Cable



Power Cord



User Guide
(you are reading it)

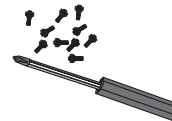

Screws (10)/
Screwdriver

These items are all you need to set up and operate the LCD TV in its basic configuration.

*Most devices (VCRs, DVD player, etc.) come with the necessary cable for connection. If you want to set up a complex system, you may need to buy extra cable, connector, etc.

How to install the TV Stand

Follow the instructions below to install the TV stand:

- 1 Open the box, and make sure all necessary parts are in the box.
The package contains:

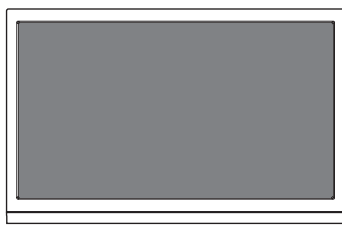
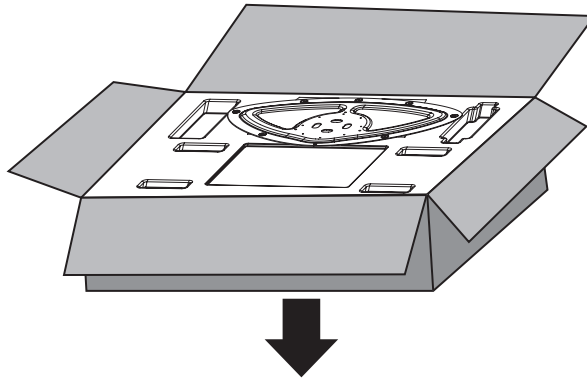

LCD TV

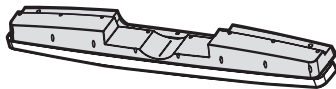

Speaker

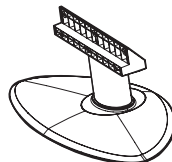

Stand

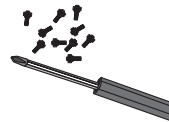

Screws (10)/Screwdriver

- 2 Lay a soft cloth on a table to protect against scratching the table or TV panel. Place the LCD TV unit face-down on the cloth.

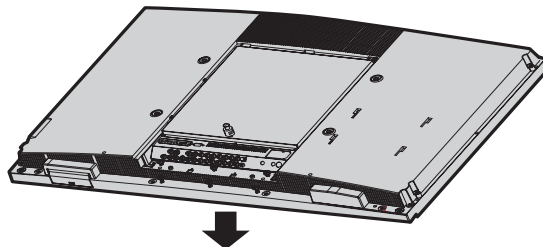

3

Fit the TV stand onto the back of the TV unit as shown below. Use the screwdriver to tighten the four screws on the rear of the speaker until the screw is firmly fixed in place.

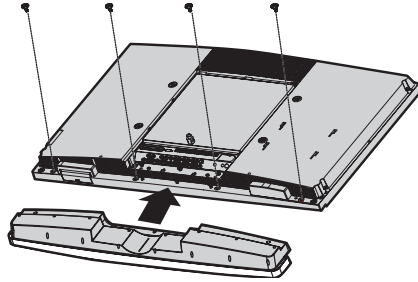

4

Hold the TV stand and place it on the six screw holes on the back of the unit as shown. Use the screwdriver to tighten the six screws on the rear of the speaker until the screw is firmly fixed in place.

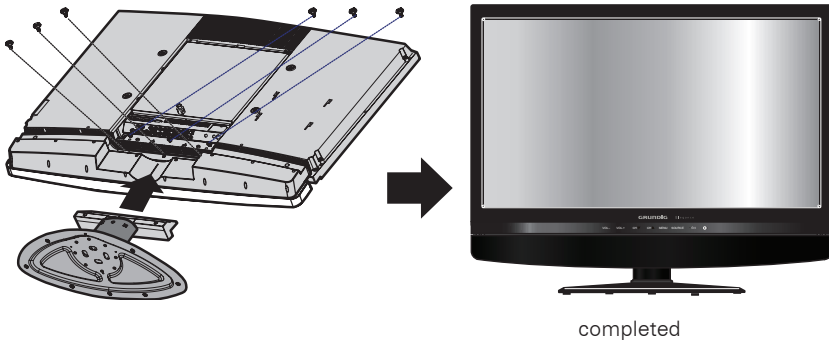

5

Adjust the stand to your desired angle. The stand angle can be rotated 30° to the right and left.

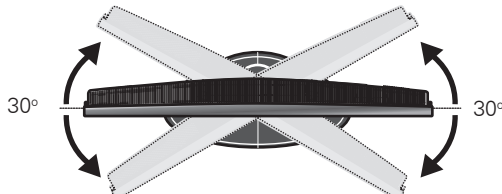

If you prefer to mount your LCD TV on a wall instead of attaching it to the stand, please reference the instructions included in the wall mounting kit (not included).

GU32DP

Please note there are different sizes of fixing screws for fixing the speaker and stand:

- * First secure the speaker pod to the TV using supplied four M4 X 12mm screws
- * Next secure the base to the TV using the supplied 6 screws. Note that the M5 X 15mm length screws are used at the top of the stand and the M5 X 30mm length screws are used at the bottom of the stand.

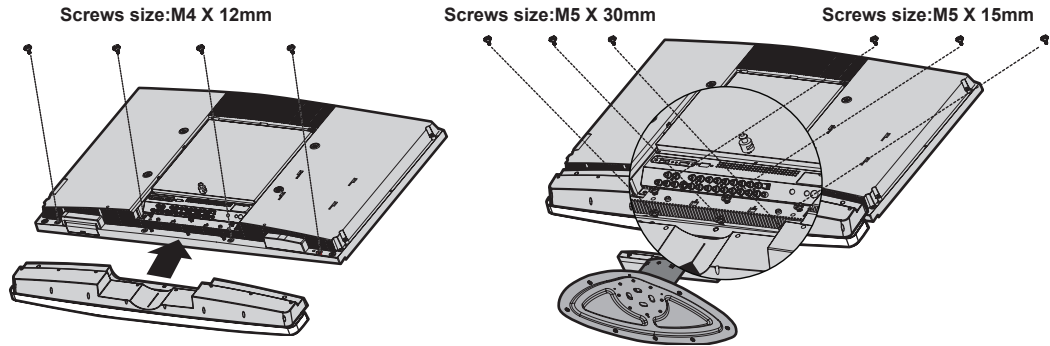

GU37DP/GU40DP

Please note there are different sizes of fixing screws for fixing the speakers and stands:

- * First secure the speaker pod to the TV using supplied four M4 X 12mm screws
- * Next secure the base to the TV using the supplied 6 M5 X22mm screws.

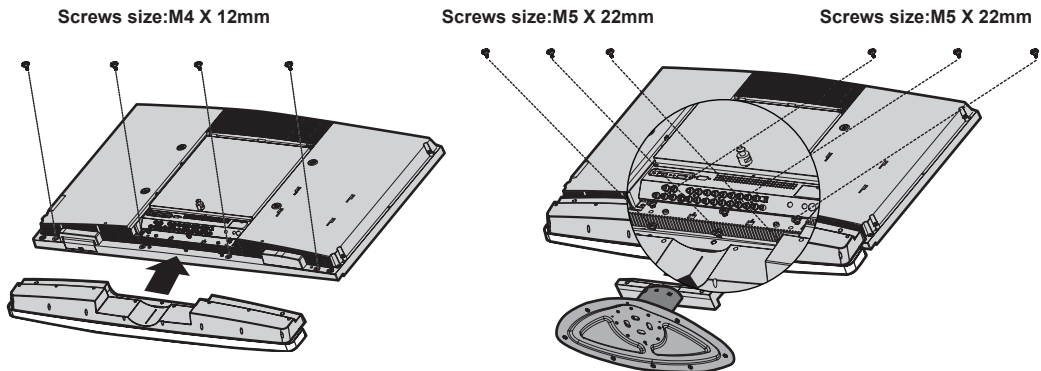

The RCA sockets on the left & right sides of the rear of TV are used for connecting the external speakers

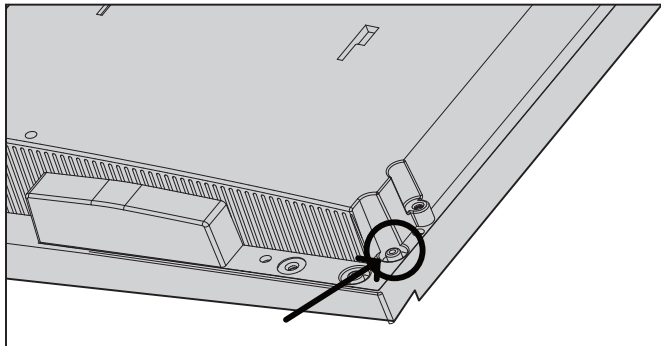

LCD TV

Front View



Right Side View

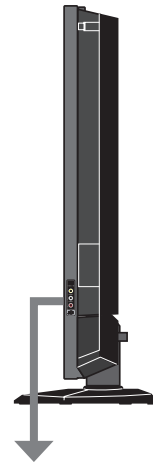

IR
Infrared Receiver

⏻/⏪
Turns the LCD TV on and into standby mode.

LED
The LED light indicates when the LCD TV is activated.

SOURCE
Used to change the Input source. Also used to enter into a sub menu and to confirm / store an adjustment or selection.

MENU
Press once to display the OSD (on screen display), press again to turn the OSD off.

VOL.-

VOL.+

CH. ▾

CH. ▲

MENU

SOURCE

⏻/⏪

⏻

CH ▲ ▾
Scans up and down through channels.
Selects sub-menu item when in the OSD mode.

VOL +/-
Adjusts the volume up and down.
Selects the main-menu item and change values for items when in the OSD mode.



HEADPHONE
Connects to the external headphone for private listening.

VIDEO/AUDIO IN
Connects to the composite Video and Audio output jacks on external video equipment.

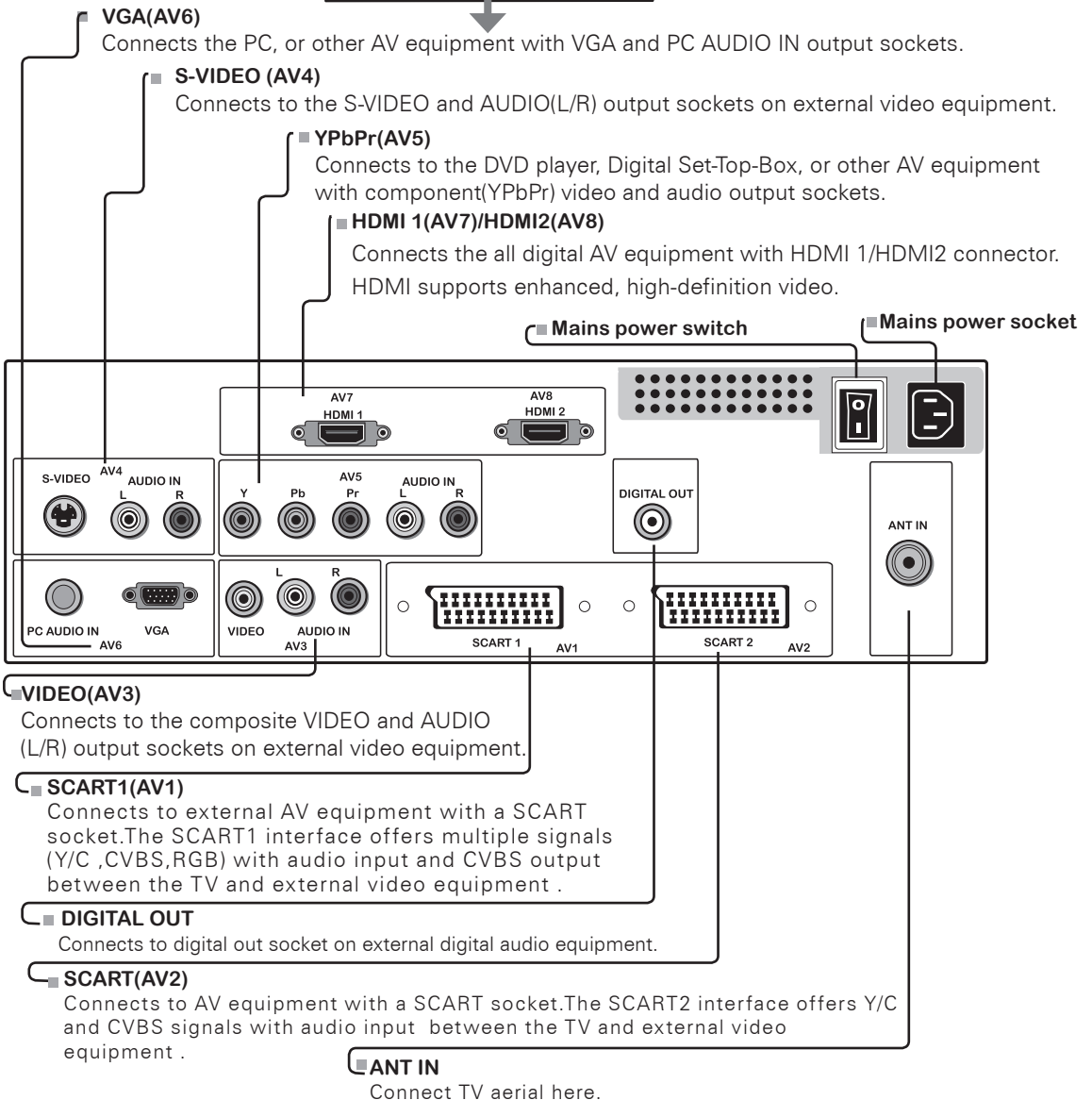

- 1 POWER**
Turns the LCD TV on and into standby mode .
- 2 MUTE**
Mutes the TV sound.
- 3 ATV/DTV**
Pressing enter ATV (analogue) or DTV (Digital) Mode.
- 4 0-9**
Select and switch to a channel by using 0-9 buttons.

- 5 SUBTITLE**
Press the SUBTITLE key to display the subtitle which is broadcast with the program on the screen.

- 6 CH. +/-**
Changes the channels up and down .

- 7 VOL. +/-**
Increases and decreases volume.

- 8 SLEEP**
Sets the LCD TV sleep time.
- Press the SLEEP button to select the number of minutes. followed by 15, 30, 60minutes and off. The timer begins to count down from the number of minutes selected.
a.To check the remaining sleep time, press the SLEEP button once.
b.To cancel the sleep time, repeatedly press the SLEEP button until the display off appears.
c. If you turn the set off after setting the sleep timer, the setting will be erased.

- 9 PIP/POP**
Turns on and off the PIP/POP (4:3/ FULL) function.

SWAP

Press to switch the picture between the main window and the sub window.

- 10 POSITION**
Select the position of the sub window.

WINDOW

Press to activate either the main menu or submenu.

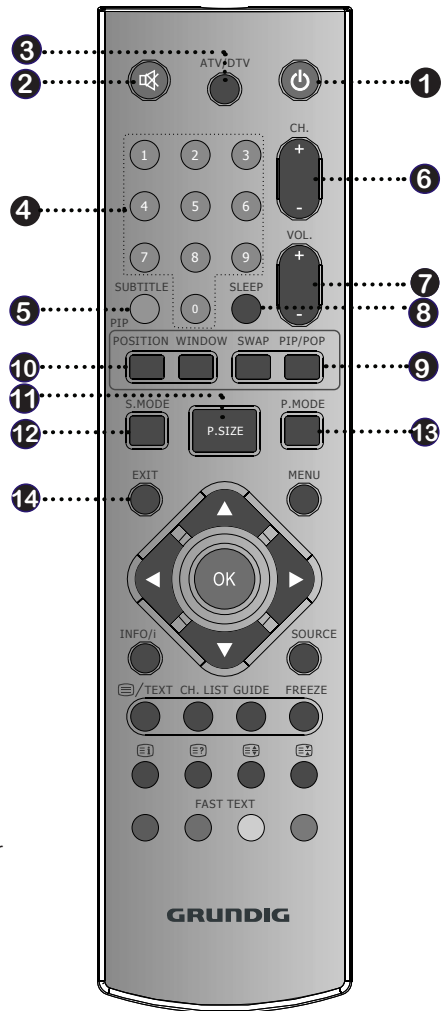

- 11 P.SIZE**
Selects from the following modes settings: 16:9,14:9, 4:3, Zoom ,Original.

- 12 S.MODE**
Selects sound mode: Movie, Music, Individual, Neutral.

- 13 P.MODE**
Selects picture mode: Custom, Standard, Vivid, Mild.

- 14 EXIT**
Exits the OSD menu (on-screen display).

15 MENU

Displays the OSD menu (on screen display).

16



Allows you to move, select and set up the OSD options.

17 INFO/i

Pressing once displays a variety of information such as the current channel and the input source. In DTV mode will show Programme Information.

18 SOURCE

Cycles among the different input signal sources.

19 /TEXT

Turns on and off the Teletext function. Enter the MHEG on the DTV Source.

CH. LIST

Display all channel list & name.

GUIDE

In DTV mode, pressing GUIDE key displays the electronic program guide on the screen.

FREEZE

Freezes and restores the picture.

20

Displays the main index in Teletext mode.



Reveals hidden information such as the answer to a quiz in Teletext mode.



Freezes a multi-page passage on screen in Teletext mode.



Displays the top, bottom or all of page, to easily read in Teletext mode.

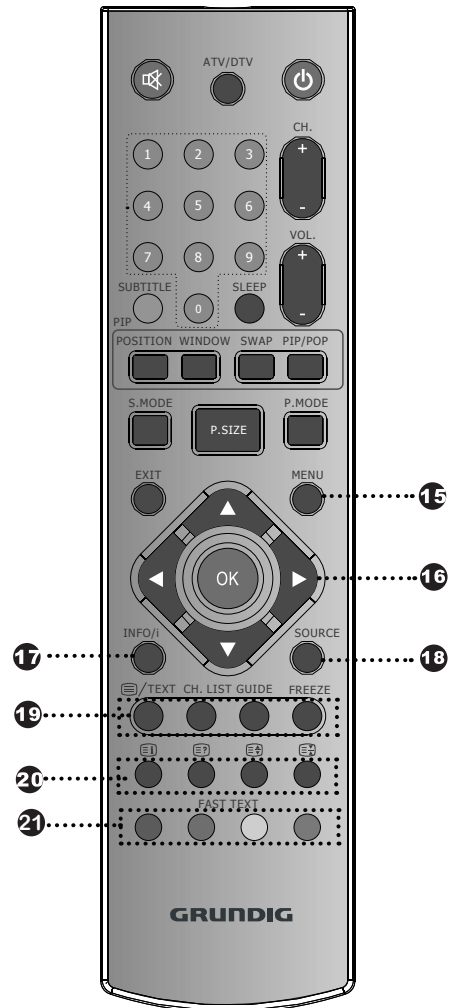

21 FAST TEXT
 Accesses the TELETEXT items or corresponding pages. The coloured buttons are used to access interactive modes when using Digital / Freeview TV channels. Allows you to exit the Subtitle and enter the MHEG (The program include the Sub / MHEG) on the DTV Source.

Remote Control

Installing the batteries in your remote control

- 1** Pull the tab of the back cover and pull up on the cover to open the battery compartment of the remote control.

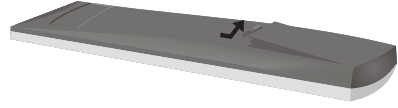

- 2** Insert two AAA size batteries. Make sure to match the (+) and (-) ends of the batteries with the (+) and (-) ends indicated in the battery compartment.

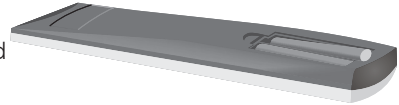

- 3** Align the lower tabs of the back cover to the remote control and squeeze the cover into place.

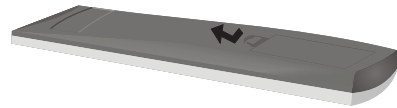

Note :

Do not use caustic cleaners(porcelain, stainless steel, toilet, or oven cleaner, etc...). You may cause damage to your remote control.

Effective range

Your remote control can be activated from up to the LCD TV 5m away, if points directly in front of the device.

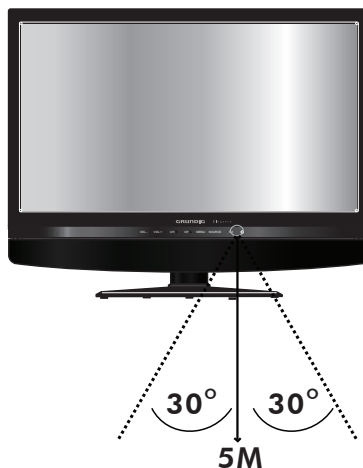

INSTALLATION

When connecting external equipment, do not connect any AC power cords to wall outlets until you have completed all the connections.

Basic Connection: Connecting aerial .

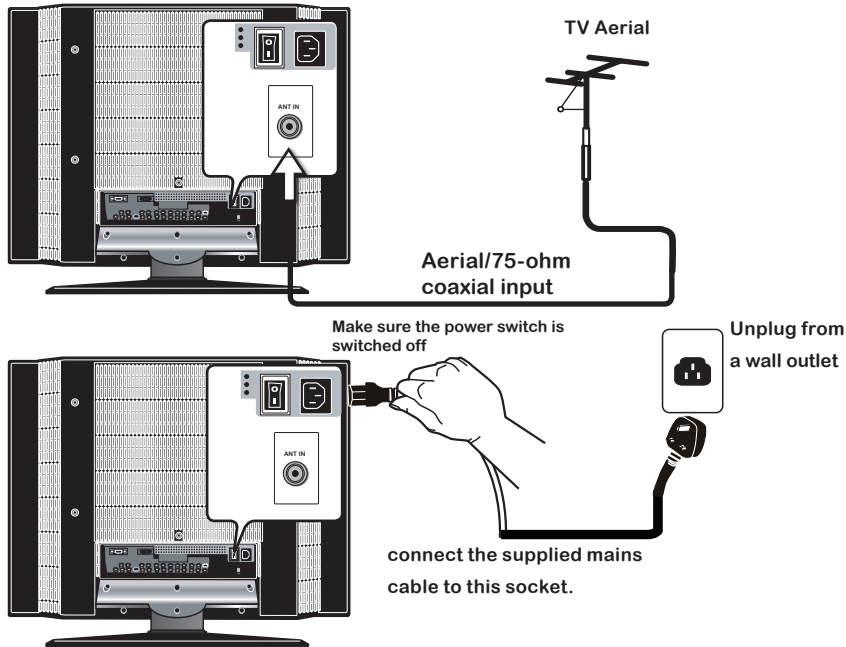

Basic Operation

Tuning in the TV channels

- 1 After connecting an aerial to your LCD TV and connecting the mains cable to the TV and 230VAC mains socket, turn the POWER SWITCH of rear TV on, a red light will show on the front centre panel of the TV.
- 2 Press the **POWER** button, the orange light will change to blue and the First Time Installation screen will show:
 1. Make sure an aerial is fitted then press OK button on the remote to start the Auto Programme Scan (APS).

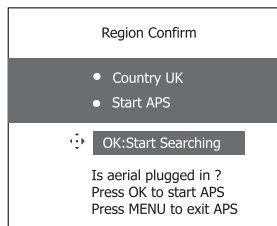

2. In a short while you will see the TV programmes briefly as each channel is received and stored in the memory. When APS is completed BBC1 digital TV will show, press CH+/- buttons to view the other channels stored. To view analogue TV press Source button and use the up / down arrow buttons to select TV and then Press the OK button. Change channels by pressing the CH +/- buttons.
- 3 To power off press the **POWER** button, the blue light will change to orange.

Selecting a source

Press the SOURCE button repeatedly until the desired select source shows on the TV (ATV/DTV/FULL SCART AV1/ HALF SCART AV2/ AV3/ AV4/ ypbprAV5/VGA AV6/HDMI 1 / HDMI)

Select TV Channel

- 1 Press the **CH.+/-** button on the remote control and the **CH. ▲/▼** button on the LCD TV to change the TV channels.
- 2 You can directly select the TV channel required by pressing 1,2 or 3 etc on the remote button pad.

Adjusting the Volume

Press the **VOL. +/-** button on the remote control or the **VOL. +/-** button on the LCD TV to adjust the volume.

To Mute the Sound

- 1 Press **MUTE** and the sound cuts off.
- 2 To turn mute off, press the **MUTE** button again, or simply press the **VOL +/-** button.

Sleep Timer

Press the **SLEEP** button continuously to select the sleep timer or turn the sleep timer from the OFF,15,30,60minutes; at the preset time, it will automatically turn off. If the TV has no input signal, it will automatically power down to standby after 15 minutes.

Connecting a HDMI source

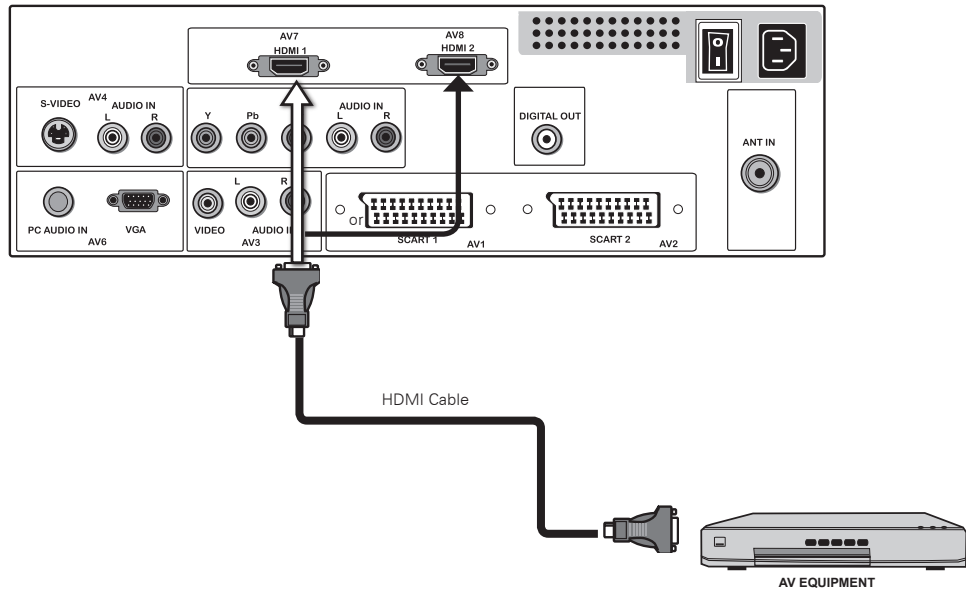

Connect an HDMI source to the HDMI input socket as show. There are 2 HDMI sockets and both can be used to connect to an HDMI Skybox or DVD player with HDMI output. HDMI cable is not supplied but are available from most TV/Hifi retail outlets.

Connecting a DVD Player

If your DVD player has (Y Pb Pr) video output, Please use component cable instead of a standard video or S-video cable (cables not supplied). Otherwise connect using a standard Scart cable (not supplied).

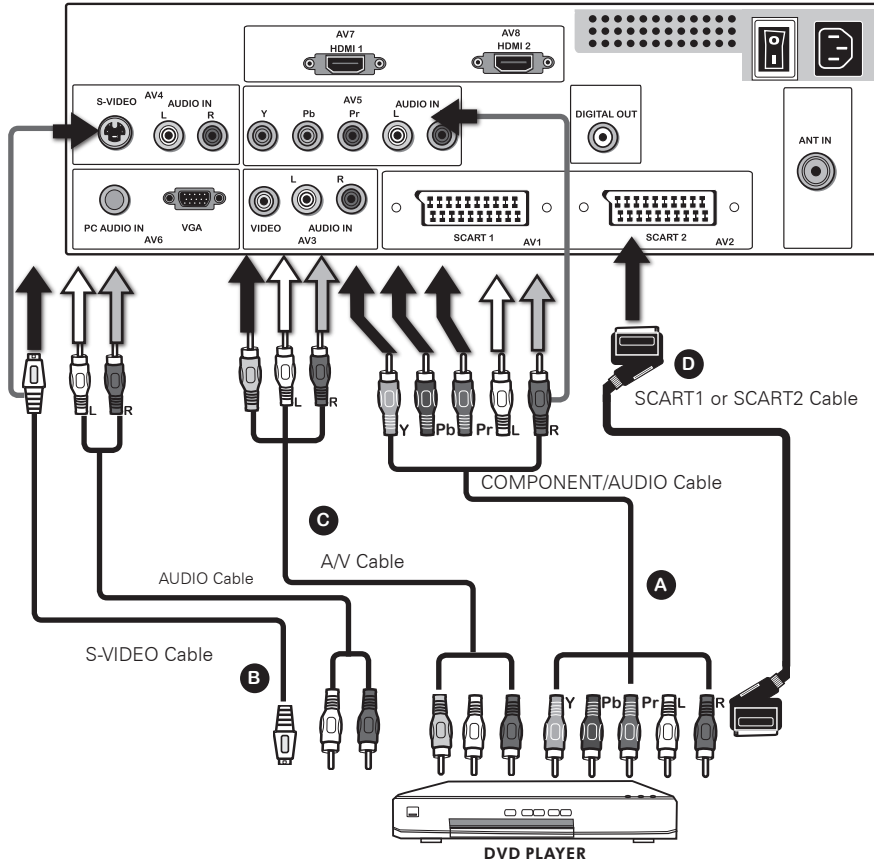

1 METHOD A (AV5)

Use a Component cable to connect the (Y Pb Pr) sockets on the DVD player to your LCD TV. Use an audio cable to connect the DVD's audio sockets to your LCD TV.

METHOD B (AV4)

Use an Audio cable to connect the DVD's audio output sockets to your LCD TV. Use a S-Video cable to connect your LCD TV and DVD player.

METHOD C (AV3)

Use an A/V cable to connect the DVD's composite output sockets to your LCD TV.

METHOD D (AV1/AV2)

Use a SCART cable to connect the DVD's SCART socket to the LCD TV's SCART socket.

2 Connect all power sources before turning on the power switch of the LCD TV or other connected equipments.

3 Press the **POWER** button to turn on your LCD TV.

4 To watch DVD, press the **SOURCE** button to select **AV1/AV2, AV3,AV4,AV5**.

Connecting a VCR & a Video Camera

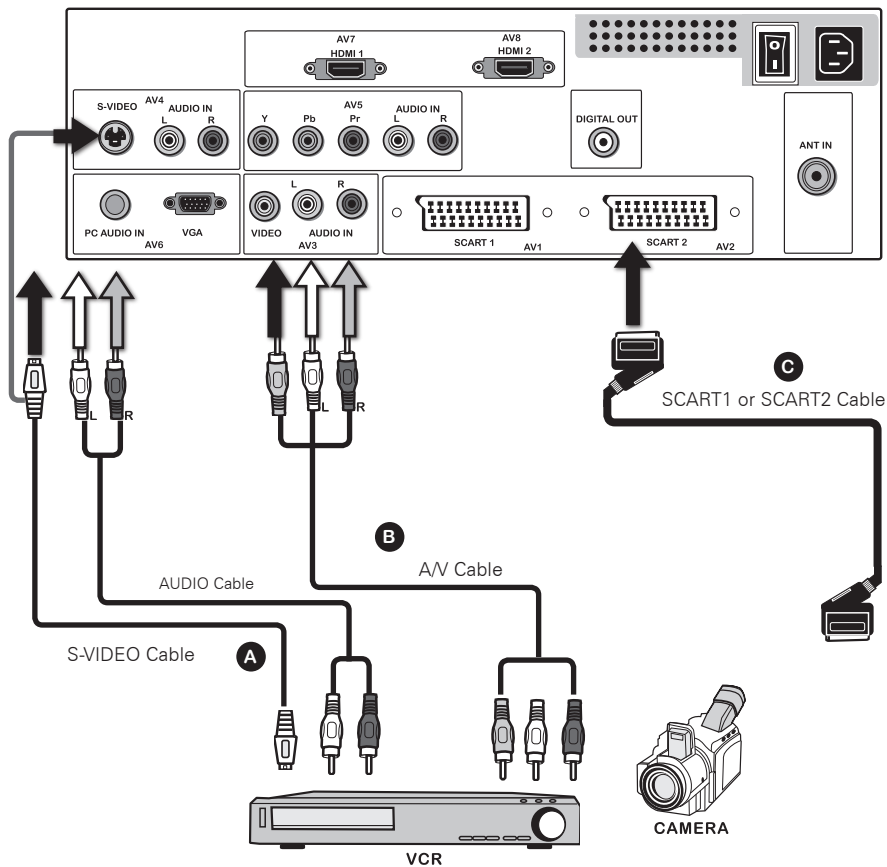

1 METHOD A (AV4)

Use an Audio cable to connect the VCR's/ the VIDEO CAMERA's audio output sockets to your LCD TV.

Use a S-Video cable to connect your LCD TV and VCR player/ VIDEO CAMERA.

METHOD B (AV3)

Use an A/V cable to connect the VCR's/ VIDEO CAMERA's composite output sockets to your LCD TV.

METHOD C (AV1/AV2)

Use a SCART cable to connect the VCR's SCART socket to the LCD TV 's SCART socket.

- 2** Connect all power sources before turning on the power switch of the LCD TV or other connected equipments.
- 3** Press the **POWER** button to turn on your LCD TV.
- 4** To watch VIDEO CAMERA, press the **SOURCE** button to select **AV3** or **AV4**.
- 5** To watch VCR, press the **SOURCE** button to select **AV1/AV2** , **AV3** or **AV4** .

Note: Not all cameras have the ability to connect to a TV. Please check your video camera user guide for compatibility.

Connecting a TV Box and Satellite Receiver

Freeview / Sky boxes will usually have scart cables supplied with them. Connect the scart cable to the scart socket on the rear of the TV.

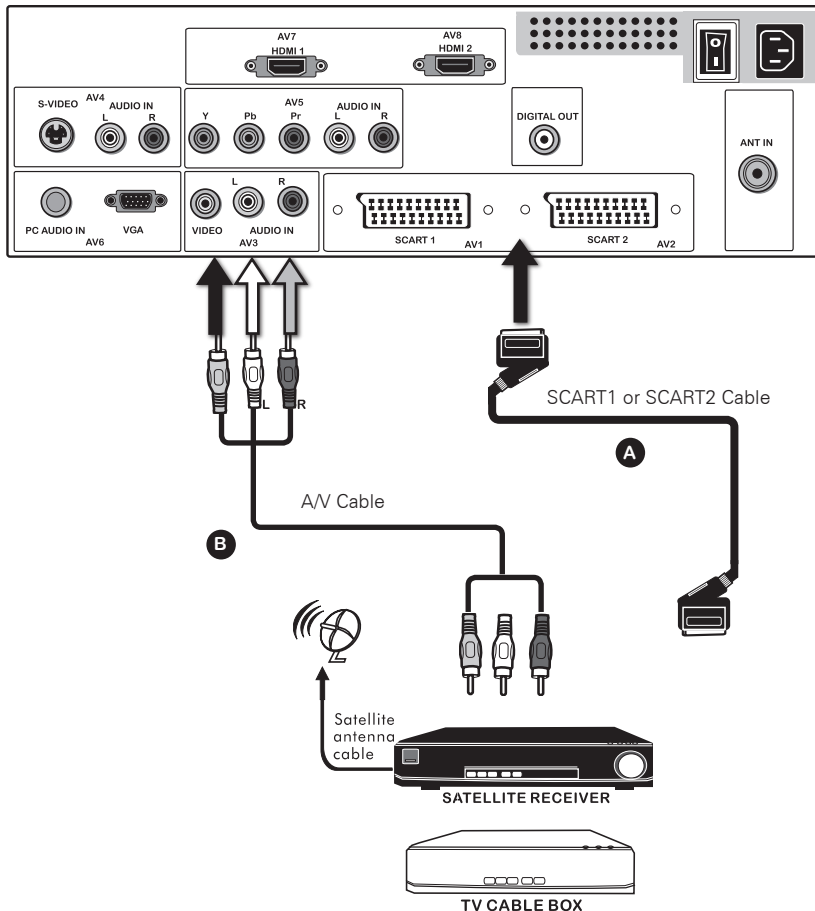

1 Method A(AV1/AV2) :

Use a SCART cable to connect the TV Cable Box's SCART socket to the LCD TV's SCART socket.

Method B(AV3) :

Use an AV cable to connect the TV Cable Box's composite output sockets to your LCD TV.

- 2 Connect all power sources before turning on the power switch of the LCD TV or other connected equipments.
- 3 Press the **POWER** button to turn on your LCD TV.
- 4 To watch TV cable box or programs satellite receiver , press the SOURCE button to select **AV1 / AV2, AV3**.

Connecting an Audio amplifier

For best Sound quality, you may want to play the LCD TV audio through a digital surround sound system.

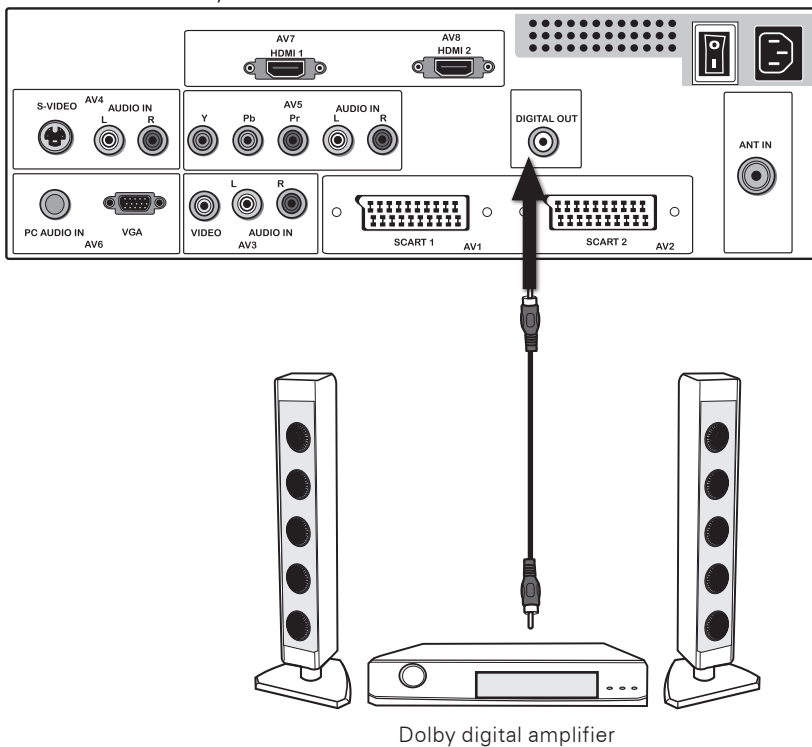

- 1** Use an RCA cable as shown above and connect between the Digital Out socket of the TV and Digital In socket of your Digital Home Surround sound system.
- 2** Connect all power sources before turning on the power switch of the LCD TV or other connected equipments.
- 3** Press the POWER button to turn on your LCD TV.

HDMI

- This TV can accept High-Definition Multimedia Interface(HDMI) .
- This TV SET supports HDCP(High-bandwidth Digital Content Protection) Protocol for TV SET (480p, 720p, 1080i) modes.
- When you connect to the output of an HD ready player (DVD Player, Set Top Box or PC) switch to the AV6(HDMI) function and the TV will automatically detect the resolution used by the HDMI source.
- To get the best picture quality, adjust the DVD Player or Set Top Box output resolution to 1280 x 720p.
- To get the best picture quality, adjust the PC graphics card to 1024 x 768, 60Hz.

How to connect

- . If Source Devices have HDMI Output , connect to the HDMI socket located at the rear of the TV using the HDMI Cable supplied with your external devise. (HDMI sends Digital Video and Audio with one cable.)

Cable sample



HDMI Cable
(not supplied with the product)

In This Mode, the Supported TV SET Resolution

Specification

- | | |
|-------------------------------------|-----------------------------------|
| - 1920 x 1080 i @ 60 Hz, 16:9 / 4:3 | - 1920 x 1080 i @ 50 Hz 16:9/ 4:3 |
| - 1280 x 720 p @ 60 Hz, 16:9 / 4:3 | - 1280 x 720 p @ 50 Hz 16:9/ 4:3 |
| - 720 x 576 p @ 50 Hz 16:9/ 4:3 | - 720 x 480 p @ 60 Hz 16:9/ 4:3 |

Wide Screen Viewing

Wide Screen function allows viewing of Different size images in wide screen mode, Press the P.SIZE button repeatedly to select the screen format you want. Note that only 4:3 and Full screen options are available in DTV mode.

16:9

When watching 4:3 image, the original image will stretch horizontally to a 16:9 image to fill the screen.

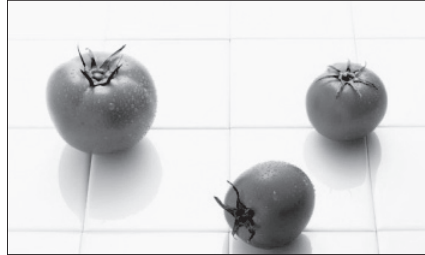

14:9

You can enjoy the picture format of 14:9 or general TV programme through the 14:9 mode.

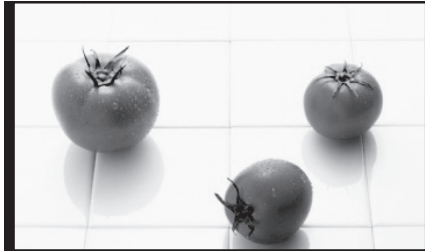

4:3

Displays at 4:3 aspect ratio.

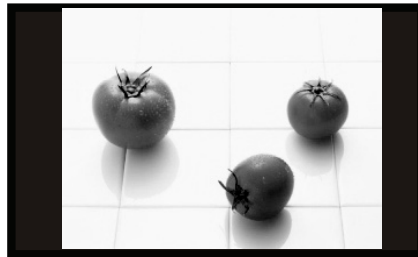

WIDE SCREEN



ZOOM

Stretches the image vertically and horizontally to fill the screen at 1:2.35 aspect ratio.



USING THE FEATURES

Using Picture-In-Picture

The PIP/POP feature allows simultaneous viewing of video from two sources (TV, VCR, DVD etc). Only one source's audio is played at a time; The audio source can be changed.

- 1 Press the PIP/POP button once to enter picture in picture mode.

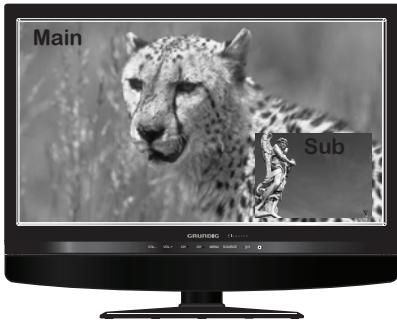

- Press SWAP to toggle the picture source between the main window and the sub window.
- Press the POSITION button to change the position of the second window.

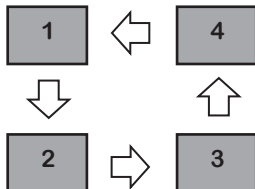

- Press WINDOW to activate either the main or sub window, then press the SOURCE button to display the Input List:

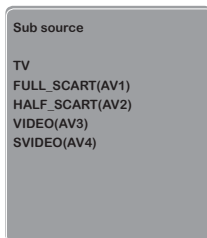

- Press ▲▼ to change input source and press the OK button.

2

Press the PIP/POP button again to view images side by side (4:3).

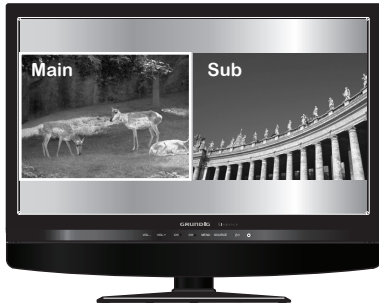

- Press the SWAP button to swap the pictures between the main and sub windows.



- Press WINDOW to activate either the main or sub window, then press the SOURCE button to display the Input List:

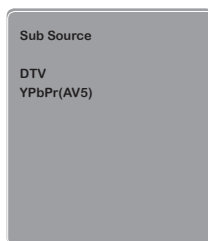

Press ▲ ▼ to change input source and press the OK button.

3

Press the PIP/POP button again to view images side by side (FULL).

4

Press the PIP/POP button again to exit .

OSD Menu Operation

1 The main menu provides access to the following menus:

Video	Adjust picture setting such as picture mode, contrast, brightness, colour, sharpness and advanced.
Audio	Adjust sound option and effects.
Setup	Adjust colour standard, sound standard, APS, Manual search, Channel setup.
Preferences	Adjust preferences such as OSD, blue screen, PIP, childlock, sleep timer, OSD timer, OSD reset.
Screen	Adjust screen such as horizontal size, horizontal position, vertical position, phase, auto sync.
DTV (Digital TV)	The DTV menu provide four submenus as follow:edit channel list,configuration, parental control, EPG (Electronic Programme Guide),with which you can set the DTV as you wish.



2 Press the **MENU** button on the remote control. The main menu will appear on the screen.

3 Use **◀/▶** to highlight your main menu option, then press **OK** to enter your selected option. Use **▲/▼** to highlight an option of the sub-menu. Use **◀/▶** to change the value of the item. Press the **EXIT** button to exit MENU.

Video

Use this **Video** setting menu to adjust the picture quality which best corresponds to your viewing requirements. The Video Menu includes the following options:

OPTION	DESCRIPTION
Picture Mode	<p>Custom: Select for user's settings. The items of video can be adjusted when the picture mode is for user's settings except advanced item.</p> <hr/> <p>Vivid: Select for enhanced picture contrast and sharpness.</p> <hr/> <p>Standard: Select for standard picture settings. Recommended for home entertainment.</p> <hr/> <p>Mild: Select for mild picture settings.</p>
Contrast	Adjust the difference between the brightness and darkness regions of the picture.
Brightness	Adjust to increase or decrease the brightness.
Colour	Allows to adjust the colour from 0 to 100.
Sharpness	Adjust to sharpen or soften the picture.



Video

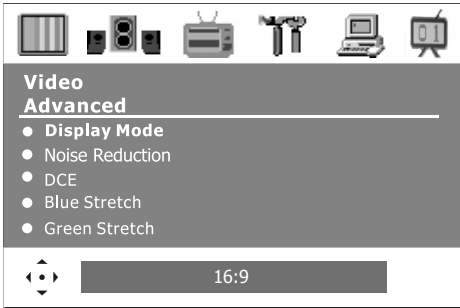

OPTION	DESCRIPTION
Advanced	Display Mode Allows you to select the display mode to be 16:9, 14:9, 4:3, Zoom, Original.
	Noise Reduction Allows you to adjust the noise reduction to be off, low, mid, high.
	DCE Allows you to adjust the (Dynamic Contrast Enhancement) to be off, low, mid, high.
	Blue Stretch Allows you to adjust the blue stretch.
	Green Stretch Allows you to adjust the green stretch.
	Color Temp. Allows you to adjust the color temp. to be cool, warm, standard.

Audio

Use this **AUDIO** setting menu to adjust the sound and balance and volume to your listening requirements.



OPTION	DESCRIPTION
Volume	presets the volume to a given setting.
Balance	Adjust to emphasize left or right speaker balance.
Surround	Allows you to turn the surround off and on.
Equalizer	Allows you to adjust the equalizer of the speakers.
Nicam	Allows you to listen to high-fidelity sound mode while watching TV: MONO, DUAL 1, DUAL 2

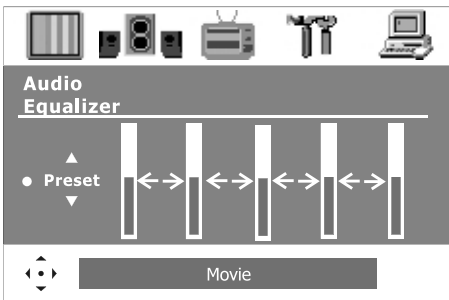

Setup (Analogue TV only)

Setup menu is only available when viewing Analogue TV. Use this **Setup** menu to select Colour Standard, Sound Standard, APS, Manual Search, Channel Setup. Use the Up/Down arrow buttons to highlight the required setting. Press the OK button to select the function. Use left / right arrow buttons to adjust the settings. Press OK to save the adjustment.

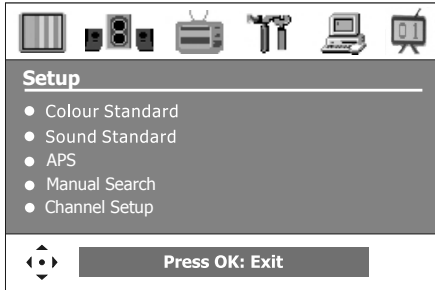

OPTION	DESCRIPTION
Colour Standard	Allows you to select the colour standard : AUTO,PAL, SECAM. UK = PAL

Sound Standard	Allows you to select the sound standard : DK, BG, I, L L'
DK	PAL D/K, SECAM D/K (East Europe / China)
BG	PAL B/G, SECAM B/G (Europe / East Europe / Asia / New Zealand / M.East / Africa / Australia)
I	PAL I (U.K. / Ireland / Hong Kong / South Africa)
L L'	SECAM L L'



APS	Start APS Press OK to start Auto Search and auto sort process. Note: Auto Sort will only operate in UK. Country Allows you select the country :Austria, Belgium, Switzerland, Czech Rep., Germany, Denmark, Spain, France, Finland, UK, Greece, Hungary, Italy, Norway, Netherlands, Portugal, Poland, Sweden, Slovenia, Slovakia, Turkey, Others.
------------	---

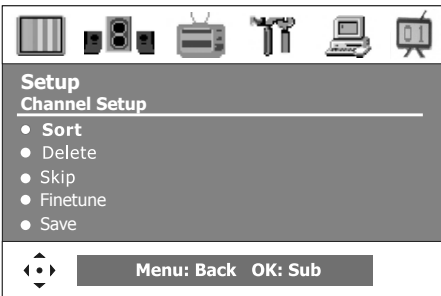

Manual Search	to manually search a store a channel. Before entering this menu select which CH preset is to be tuned (1,2 etc) enter the MANUAL menu then press the right arrow button to start the search. when the correct TV channel is located press the OK button to store the channel. Repeat all above to store the next channel.
----------------------	---

Channel Setup	Press the ► button to select Sort, Delete, Skip, Finetune, Save.
Sort	Allows you to manually sort the stored programme.
Delete	Allows you to delete the stored programme.

Skip	Allows you to skip the stored programme.
Finetune	Allows you to finetune the if signal is too weak or picture is blurry. stored programme.
Save	Allows you to save the setup.

Preferences

Use this **Preferences** setting menu to set up some features: OSD, Blue Screen, Childlock, Sleep Timer, OSD Timer, OSD Reset.

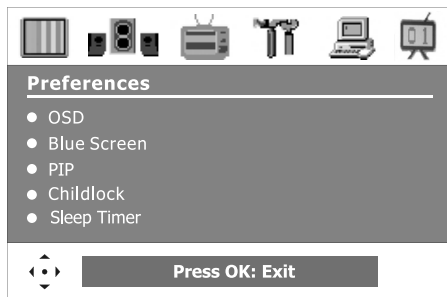

OPTION	DESCRIPTION
OSD	Language : Allows you to select the OSD to be English, German, French, Spanish, Italian, Dutch, Portugese, Polish or Russian. Transparency: Allows you to adjust transparency from 0 to 15.
Blue Screen	Allows you to select the blue screen to be off or on.
PIP	Allows simultaneous viewing of video from two sources.
Childlock	Allows you to select the childlock to be yes or no. (Default password is 0000. golden password is 3796.) Change Pin: Allows you to change the 4 -digit password.
Sleep Timer	Allows you to select the sleep timer to be off, 15min, 30min, 60min.
OSD Timer	Allows selection of the display time of the on-screen menu: 5 s, 10 s, 15 s, 20 s, 25 s.
OSD Reset	This will restore the settings to original factory settings.

Screen(Only for VGA)



OPTION	DESCRIPTION
Horizontal Size	Allows you to adjust the Horizontal Size from 0 to 100.
Horizontal Position	Allows you to adjust the Horizontal Position of the picture.
Vertical Position	Allows you to adjust the Vertical Position of the picture.
Phase	Allows you to improve focus clarity and image stability.
Auto Sync.	Allows to auto synchronize VGA signal.

USING THE DTV FEATURES

DTV OSD Menu Operation

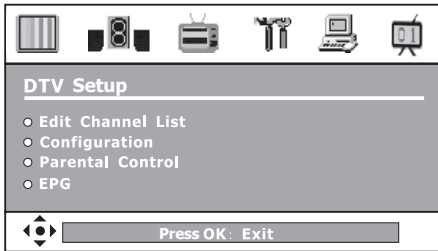

OPTION

DESCRIPTION

Edit Channel List

Lock some channels that are not suited for younger members of the family, skip/add the channel list as you wish.

Configuration

Add new channel, set audio language, subtitle language, as you wish. Upgrade the system. View the signal information.

Parental Control

Enable or Disable the menu protection system and allows the PIN code to be changed.

EPG

Electronic Program Guide

Edit Channel List

Highlight the Edit Channel List option, then press OK button, there are three items in the menu.

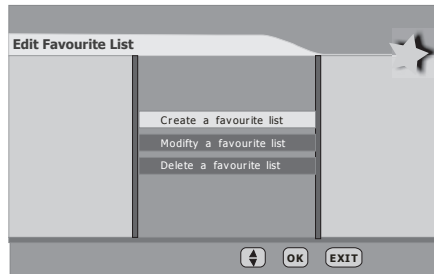

CREATE A FAVOURITE LIST

Highlight the Create a favourite list item, pressing OK button, then The menu is displayed on the screen now. Once you enter the Created a favourite list menu, a new channel list will be created, you can create a maximum of 4 favourites list.

You can lock or unlock the selected channel by pressing the RED button. A locked channel means that the selected channel cannot be viewed without entering in the child lock code. Pressing the BLUE button to skip or add the selected channel. If you want to skip or add all, first press the GREEN button, then press either the RED button to skip all, or the GREEN button to add all. A channel selected as a locked appears in the channel list with a lock icon (red button) against the channel name, a channel selected as an added channel appears in the channel list with a add icon (tick) against the channel name.



By pressing the YELLOW button you can sort the channels in the list. Then you can sort the channels alphabetically by pressing the RED button or sort the channels manually by pressing the BLUE button. If you have locked several channels, by pressing the YELLOW button, the locked channels will be placed at the bottom of the Channel list in alphabetical sort.



When you have completed your editing, press the EXIT button to quit the favourite channel list menu. The next menu will ask if you want to save the changes you have made, using the ◀/▶ buttons to highlight the YES option, and press the OK button to save the changes.

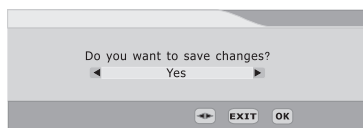

Once you lock a channel, you must enter the PIN Code that is set in the parental control menu at first before the channel is displayed.

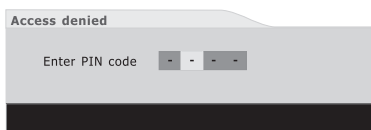

If you skip a channel, it cannot be shown in the list menu (Press OK button will pop-up the favorite channel list menu when you watch the digital terrestrial television) unless you add it again. (In the channel list menu, the skipped channel name is not shown.)

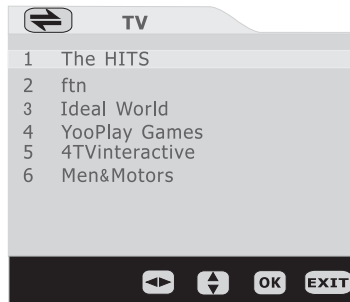

MODIFY A FAVOURITE LIST

You can modify the favourite list which you have created. The list named "TV / RADIO" is the default list, that all the favourite lists are made from. Select a favourite list, then press OK button to modify the list as you do in the favourite list menu.



DELETE A FAVOURITE LIST

Using the ▲/▼ buttons to highlight the list name which you want to delete, then pressing the OK button to delete the favourite list, the pop-up menu will ask if you confirm or cancel the delete operation.

(Note: The default favourite channel list name isn't displayed in the list, so you can only delete the list name you created.)



Configuration

Highlight the Configuration option, then press OK button to enter the selected option. The configuration menu is displayed on the screen now.

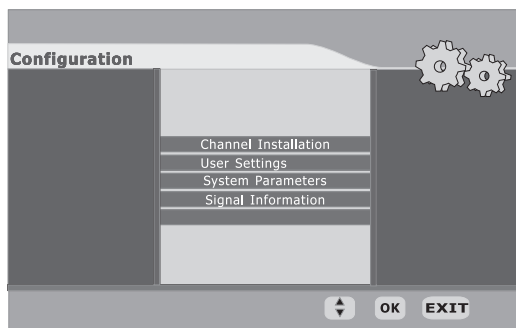

Channel Installation

Use these options if you have moved location or want to rescan for new channels. Press OK button to display the channel installation menu.

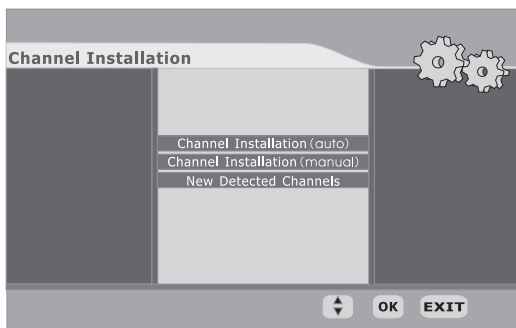

If you want TV to auto search the channels, press OK button to continue. Then you should choose the installation type by using the ◀/▶ buttons and press the OK button to start the installation process. If you choose 'add', the new channels will be added in the channel list. If you choose 'new', the new channels will replace the previous channels in the channel list.

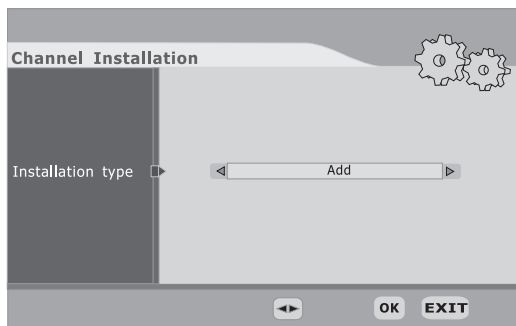

User Settings

Using the ▲/▼ buttons to highlight the user settings item in the configuration menu, then press OK button to display the user settings menu.



Audio Language

This function select which language soundtrack you will hear when switching to a channel broadcasting with multiple soundtracks. Highlight the audio language line in the user settings menu and use ◀/▶ buttons to cycle through the language options.

Subtitle language

This function selects the desired subtitle language whenever subtitle information is broadcast. Highlight the subtitle language line in the user settings menu and use ◀/▶ buttons to cycle through the language option.

System parameters

Using the ▲/▼ buttons to highlight the system parameters item in the configuration menu, then press OK button to display the system parameters menu.

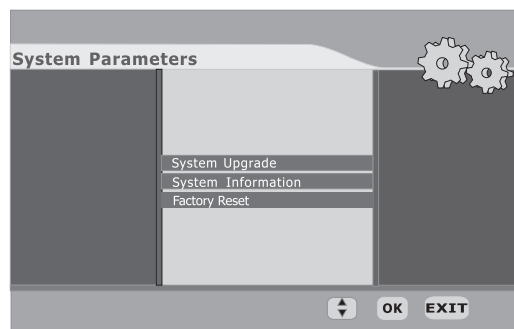

System Upgrade

Highlight the System Upgrade item in the system parameter menu, pressing OK button to display the System Upgrade menu. press OK button to upgrade system. If there is a new software, the unit will upgrade itself.

System Information

Highlight the system information item in the system parameter menu, pressing OK button to display the system information menu. You can view the system information in this menu, however, you can modify nothing in this menu, Pressing OK button to quit.

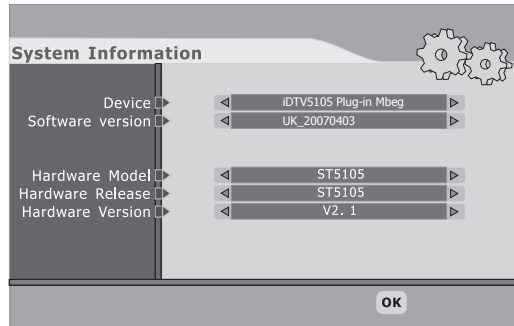

Signal information

Highlight the Signal information item in the configuration menu, pressing OK button to display the Signal information menu. Cycle through the channel option by using the ◀/▶ buttons on the remote control. The signal level and signal quality of the channel that offers the upgrade software can be observed on the two bar graphs. The bar graphs of signal quality and signal level give a good indication of whether the selected channel is likely to be found. If the signal quality bar is high as well then it is a digital frequency and digital channels will probably be found.



Parental Control

Highlight the parental control line in the parental control menu and use ◀/▶ buttons to cycle through the enable and disable option. Toggle this option to enable, then the following items can be altered.

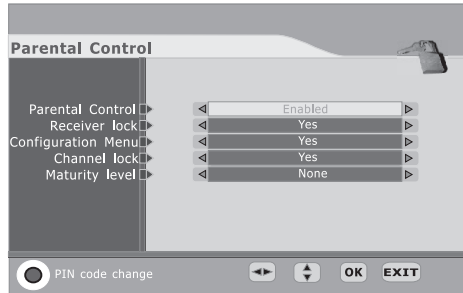

Receiver lock

You should enter the PIN CODE before you can see the DTV program while you power on the TV and select the DTV source.



Configuration menu

If you toggle this option to YES, you will enter the PIN CODE before enter the configuration menu.

Channel lock

If you toggle this option to YES, the channels you locked in the edit channel list menu can't be displayed before you enter the PIN CODE.

Maturity level

There are 18 levels total. If you toggle this option to a number (1-18), for example, you toggle it to 15, that's to say, if the channels broadcast material is not suitable for the family members who are under 15 years old, you must enter the PIN CODE before you can view them. (The maturity level information should be broadcast with these programs.)

PIN Code change

Pressing the 'RED' button will popup the PIN code change menu, enter the previous code by using the 0-9 buttons on the remote control, then enter the new code twice to confirm and this menu will disappear (The PIN is factory set to 0000). Pressing EXIT to quit without saving the new code.

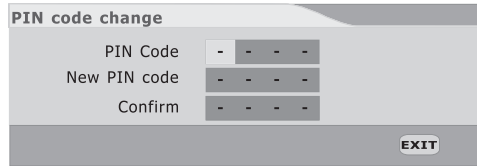

Pressing OK button to quit the parental control menu with saving these alteration. Pressing EXIT button to quit the parental control menu without saving these alteration.

Note: If you forgot the code which you set it, you can press RED-RED-GREEN-GREEN-YELLOW-YELLOW-BLUE-BLUE button to enter the PARENTAL CONTROL SUB-MENU to change the new mode

EPG

EPG (Electronic Programme Guide) menu is reached by pressing GUIDE button, quit by pressing GUIDE button again. Current program is highlighted. Use Channel Up/Down ▲/▼ buttons to change channels and view the other programmes on the selected channel. Press the Arrow up / Arrow down navigation buttons to scroll through and show programme content. There is a 7day EPG, you can see the other days channel list by using Left / right navigation arrow ◀/▶ buttons.

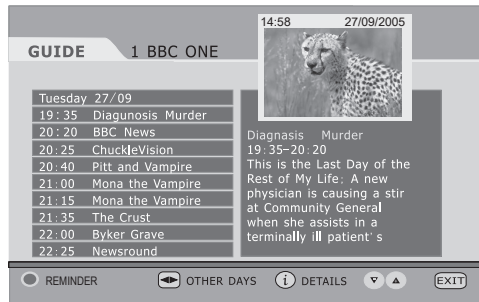

The short description of the highlighted channel is shown under the image window, and you can see the extended description by pressing the INFO or OK button and by pressing this button again you can close this window. Press "RED" button you can add a reminder flag to any desired programme that you want to watch in the future by pressing this button again you can cancel this reminder.

Once a reminder has been set press EXIT button to return to normal viewing. At the programmed time the TV will show and OSD requesting you switch to the new channel. Press OK or select NO as desired. If no button is pressed the TV will automatically change channels for you.



TROUBLESHOOTING

Before contacting Grundig Helpline, check the following chart for a possible cause of the trouble you are experiencing and for a solution.

HELPLINE 0871 230 1777

PROBLEM	SOLUTION
TV will not turn on	<ul style="list-style-type: none"><input type="checkbox"/> Make sure the power cord is plugged in.<input type="checkbox"/> The batteries in the remote control may be exhausted. Replace the batteries.
No picture, no sound	<ul style="list-style-type: none"><input type="checkbox"/> Check the TV aerial / Connection.<input type="checkbox"/> Press the POWER button on the remote.<input type="checkbox"/> Press the TV button on the remote, then press the SOURCE button repeatedly to select the connected video sources.<input type="checkbox"/> Make sure that the main power switch on the back panel is switched on. And power indicator shows.
Poor picture, sound OK	<ul style="list-style-type: none"><input type="checkbox"/> Check the interface cable between TV and antenna/cable TV.<input type="checkbox"/> Try another channel, the station may have broadcast difficulties.<input type="checkbox"/> Adjust the Brightness/Contrast options in the VIDEO Menu.
Picture OK, Poor sound	<ul style="list-style-type: none"><input type="checkbox"/> Sound may be muted. Press the MUTE button on the remote.<input type="checkbox"/> Press the TV button on the remote, then press the VOL.+ button to increase the volume.
Audio noise	<ul style="list-style-type: none"><input type="checkbox"/> Move any infrared equipment away from the TV.

SPECIFICATIONS

Model	GU32DP	GU37DP
Panel System	32 inch LCD panel	37 inch LCD panel
Display Resolution	1366 pixels (horizontal) x 768 pixels (vertical)	1366 pixels (horizontal) x 768 pixels (vertical)
Television System	PAL-I	PAL-I
Brightness	500 cd/m ²	500 cd/m ²
Contrast Ratio	1200:1	1000:1
Inputs/Output		
SCART	2	2
HDMI	2	2
VGA	1	1
PC Audio In	1	1
Video In	2	2
S-video In	1	1
Phones	1	1
Y Pb Pr	1	1
Digital Out	1	1
ANT In	1	1
Speaker Power	10 W+10 W	12 W+12 W
Power Source(MAX)	AC230 V~, 50Hz, 200W	AC230 V~, 50Hz, 300W
Dimension(W x D x H)	792 x 270 x 656.4mm	926.8 x 270 x 733.4mm
Weight(Net)	19.6 Kg	26.5 Kg

SPECIFICATIONS

Model	GU40DP
Panel System	40 inch LCD panel
Display Resolution	1366 pixels (horizontal) x 768 pixels (vertical)
Television System	PAL- I
Brightness	500 cd/m ²
Contrast Ratio	1200:1
Inputs/Output	
SCART	2
HDMI	2
VGA	1
PC Audio In	1
Video In	2
S-video In	1
Phones	1
Y Pb Pr	1
Digital Out	1
ANT In	1
Speaker Power	12 W+12 W
Power Source(MAX)	AC230 V~, 50Hz, 300W
Dimension(W x D x H)	984.8 x 270 x 754mm
Weight(Net)	28.5 Kg

For the display modes listed below, the screen image has been optimized during manufacture.

VGA TIMING

Dot X Line	Horizontal Frequency(kHz)	Vertical Frequency(Hz)
640 x 480	31.46	59.94
640 x 480	37.86	72.80
640 x 480	37.50	75.00
800 x 600	37.87	60.31
800 x 600	48.07	72.18
800 x 600	46.87	75.00
1024 x 768	48.36	60.00
1024 x 768	56.47	70.06
1024 x 768	60.02	75.02