

# Goodmans

## INSTRUCTION MANUAL

TFT LCD TV

With Inbuilt DVD player, SD and USB Interface

MODEL : GTVL19W17HVF

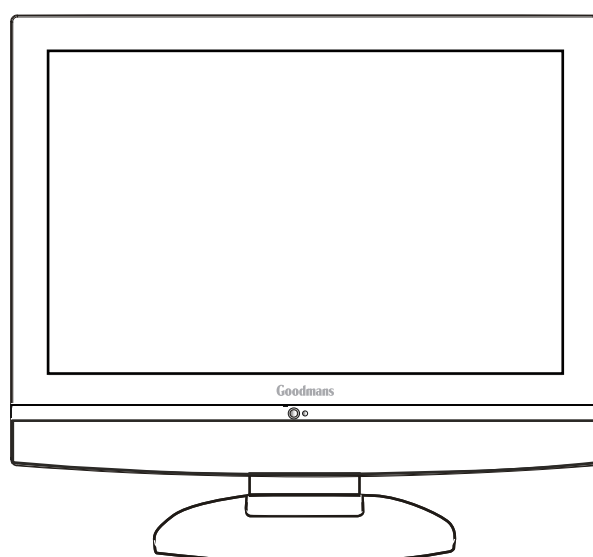

Read these instructions thoroughly before attempting to connect, operate or adjust this player. Retain the book for future reference.

Goodmans Web Site: [www.goodmans.co.uk](http://www.goodmans.co.uk)

Email: [cecustomerservice@albapl.co.uk](mailto:cecustomerservice@albapl.co.uk)

**Goodmans Helpline 0871 230 1777**

## IMPORTANT SAFETY INSTRUCTIONS

### WARNING

To reduce the risk of fire or electric shock, do not expose this equipment to rain or moisture.



**CAUTION**  
RISK OF ELECTRIC SHOCK  
DO NOT OPEN



**CAUTION: TO AVOID THE RISK OF ELECTRIC SHOCK,  
DO NOT REMOVE COVER (OR BACK).  
NO USER-SERVICEABLE PARTS INSIDE.  
REFER SERVICING TO QUALIFIED SERVICE PERSONNEL.**



This symbol is intended to alert the user to avoid the risk of electric shock, do not disassemble this equipment by anyone except a qualified service personnel.



This symbol is intended to alert the user to the presence of important operating and maintenance instructions in the literature accompanying the appliance.



Invisible laser radiation when open and interlocks defeated.

**CAUTION** avoid exposure to beam.

### CAUTION

Use of controls or adjustments or performance of procedures other than those specified herein may result in hazardous radiation exposure.

## MAINS PLUG WIRING

### Electrical Information

This appliance is fitted with a BS1363/A 13 amp plug. If it is not suitable for your supply sockets it must be removed and replaced with an appropriate plug. If the plug becomes damaged and/or needs to be replaced please follow the wiring instructions below. The plug removed must be disposed of immediately. It must not be plugged into a supply socket as this will be an electrical hazard. If the fuse needs to be replaced it must be of the same rating and ASTA approved to BS1362. If the plug is changed, a fuse of the appropriate rating must be fitted in the plug, adapter or at the distribution board. If the fuse in a moulded plug is replaced, the fuse cover must be refitted before the appliance can be used.

### Wiring Instructions

The supply cable will be either 2-core or 3-core. Follow the appropriate wiring instructions given below. In both cases ensure that the outer sheath of the cable is firmly held by the cable clamp.

#### 2- CORE

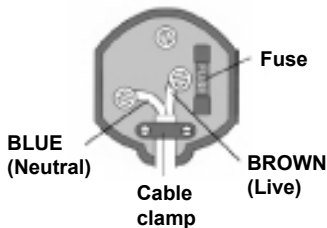

**WARNING!** Do not connect either wire to the earth terminal.



This symbol indicates that this 2-core appliance is Class II and does not require an earth connection.

The wire coloured blue must be connected to the terminal marked with the letter N or coloured black.

The wire coloured brown must be connected to the terminal marked with the letter L or coloured red.

#### 3- CORE

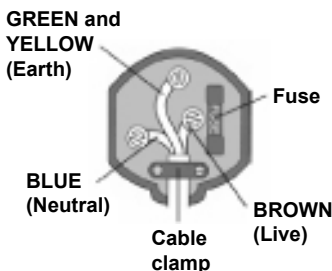

**WARNING!** This appliance must be earthed.

The wire coloured green and yellow must be connected to the terminal marked with the letter E, or by the earth symbol,  $\perp$ , or coloured green or green and yellow.

The wire coloured blue must be connected to the terminal marked with the letter N or coloured black.

The wire coloured brown must be connected to the terminal marked with the letter L or coloured red.

## WARNINGS

- Unqualified attempts to repair this TV are not allowed. Refer repairs to this unit to a qualified technician only.
- Do not disassemble this unit. There are dangerous-voltage parts inside that may cause electric shock even after power is disconnected.
- Store your unit in a clean, dry environment, Unplug the unit immediately it gets wet, and consult your servicing technician.
- Always unplug the unit before cleaning it. Wipe dust off the cabinet of the unit with clean & dry & soft cloth. Apply non-ammonia cleansing lotion onto the cloth, not directly onto the screen.
- Do not place heavy objects on top of the unit.
- Avoid exposing your unit directly to sunlight or other heat sources.
- Put your unit in a well-ventilated area away from high humidity.
- Do not expose this TV to rain or moisture, dripping or splashing.

### Safety Tips

- If smoke, abnormal noise or odour comes out of your unit, unplug from the mains supply immediately and call your dealer.
- Never try to repair the your unit on your own. Always call your dealer for repairs.

### Note

This user's manual contains for-reference-only graphics and information that are subject to change without notice.

### WEEE:

This appliance is labelled in accordance with European Directive 2002/96/EG concerning used electrical and electronic appliances(waste electrical and electronic equipment - WEEE). The guideline determines the framework for the return and recycling of used appliances as applicable throughout the EU.

# CONTENT

## ■ PREPARTION

|                             |    |
|-----------------------------|----|
| Key Features.....           | 5  |
| Package Contents.....       | 6  |
| Setting Up Your LCD TV..... | 7  |
| Your LCD TV.....            | 8  |
| Remote Control.....         | 12 |

## ■ INSTALLATION

|  |    |
|--|----|
| Connecting a TV Cable or Aerial.....             | 14 |
| Connecting a VCR & Video Camera.....             | 16 |
| Connecting a TV box and satellite Receiver ..... | 17 |
| Connecting an Audio Receiver .....               | 18 |
| HDMI.....  | 19 |

## ■ USING THE FEATURES

|                                    |    |
|------------------------------------|----|
| Basic Operation.....               | 20 |
| OSD Menu Operation.....            | 21 |
| The Video Settings.....            | 22 |
| The Audio Settings.....            | 22 |
| The Setup Settings.....            | 23 |
| The Parental Settings.....         | 24 |
| The Screen Settings.....           | 24 |
| Using The Digital TV Features..... | 25 |
| Using The DVD Features.....        | 34 |

## ■ SPECIFICATIONS.....44

## Key Features

### Various Audio/Video terminals for external equipment connection

- 1 set of composite A/V input terminals
- 1 SCART input terminals
- 1 set of component Video input terminals
- 1 VGA/ Audio input terminal
- 1 HDMI/Audio input terminals
- 1 Headphone terminal

### High Definition Multimedia Interface (HDMI)

- High Definition Multimedia Interface (HDMI) is a small, user-friendly interconnect that can carry up to 5 Gbps of combined video and audio in a single cable. This system eliminates the cost, complexity and confusion of multiple cables used to connect current A/V systems.

### HDTV Component Video Inputs

- Offers the best video quality for DVD(480p) and digital set-top-box (HD1080i, 720p) connections.

### WSS(Wide Screen Scale) Function

- This function can automatically convert and display any aspect ration (4:3 / Wide) TV broadcast signal.

### Built-in ATV and DTV Tuners

- The built-in DTV tuner allows the reception of DVB-T broadcasting without the addition of a set-top box.

## DISPLAY MODES

The screen resolution has been optimized during production for the display modes listed below.

If the signal from the system equals the standard signal mode, the screen adjusts automatically. If the signal from the system is not equal to the standard signal mode, adjust the screen resolution by referring to your video card user guide, otherwise there may be no video.

### Video signal: (VGA Standard)

| Resolution (Dot X Line) | Vertical Frequency(Hz) | Horizontal Frequency(kHz) |
|-------------------------|------------------------|---------------------------|
| 640 x 480               | 59.94                  | 31.46                     |
|                         | 72.80                  | 37.86                     |
|                         | 75.00                  | 37.50                     |
| 800 x 600               | 60.31                  | 37.87                     |
|                         | 72.18                  | 48.07                     |
|                         | 75.00                  | 46.87                     |
| 1024 x 768              | 60.00                  | 48.36                     |
|                         | 70.06                  | 56.47                     |
|                         | 75.02                  | 60.02                     |

## Package Contents

Make sure all of the following contents are included.

- LCD TV

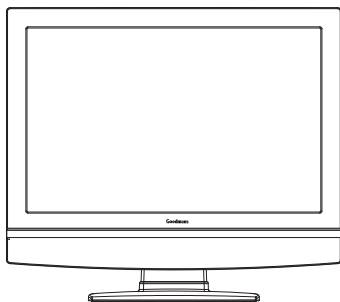

- Remote Control/  
AAA Batteries x 2

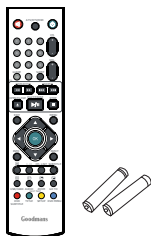

- VIDEO Cable



- AUDIO Cable



- Power Adapter



- Power Cord



- User's Manual



- Quick Start Guide



These items are all you need to set up and operate the LCD TV in its basic configuration.



Make sure all of the above contents are included in the package. If any items are missing please contact your dealer.

## Setting Up Your LCD TV

If you prefer to mount your new TV on a wall instead of attaching it to the stand, please reference the instructions included in the wall mounting kit (not included).

 Ensure the TV stand is still attached with the bottom foam packaging material in the package.

Read all instructions before continuing with the stand installation.

a. Open the box, and make sure all necessary parts are in the box. The package contains:



LCD TV



STAND

b. Cover an even stable surface with a soft cloth. Place the LCD TV unit face-down on the cloth. Fit the stand onto the bottom of the LCD TV unit as shown:



c. Then push until stand into the LCD TV's stand socket.





## How to setup the TV

- 1 Use a supplied antenna cable to connect the VHF/UHF signal to the LCD TV's ANT. terminal (refer to page 15).
- 2 Connect the DC plug of the AC-DC power adapter to the DC 12V IN socket at the back of the TV. Connect the other end of this cable to a 3 pin Power Cord.
- 3 Insert the 2 batteries supplied in remote control.

Pull the tab of the back cover and pull up on the cover to open the battery compartment of the remote control.

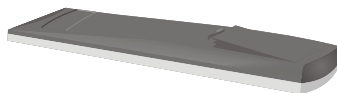

Insert two AAA size batteries. Make sure to match the (+) and (-) ends of the batteries with the (+) and (-) ends indicated in the battery compartment.

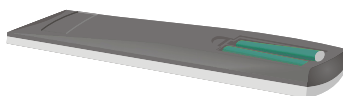

Align the lower tabs of the back cover to the remote control and squeeze the cover into place.

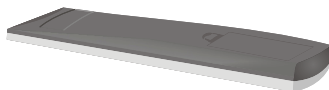

Do not use caustic cleaners (porcelain, stainless steel, toilet, or oven cleaner etc.) on the remote, as it may suffer damage.

# Your LCD TV

## Front/Left /Right Side View and Controls

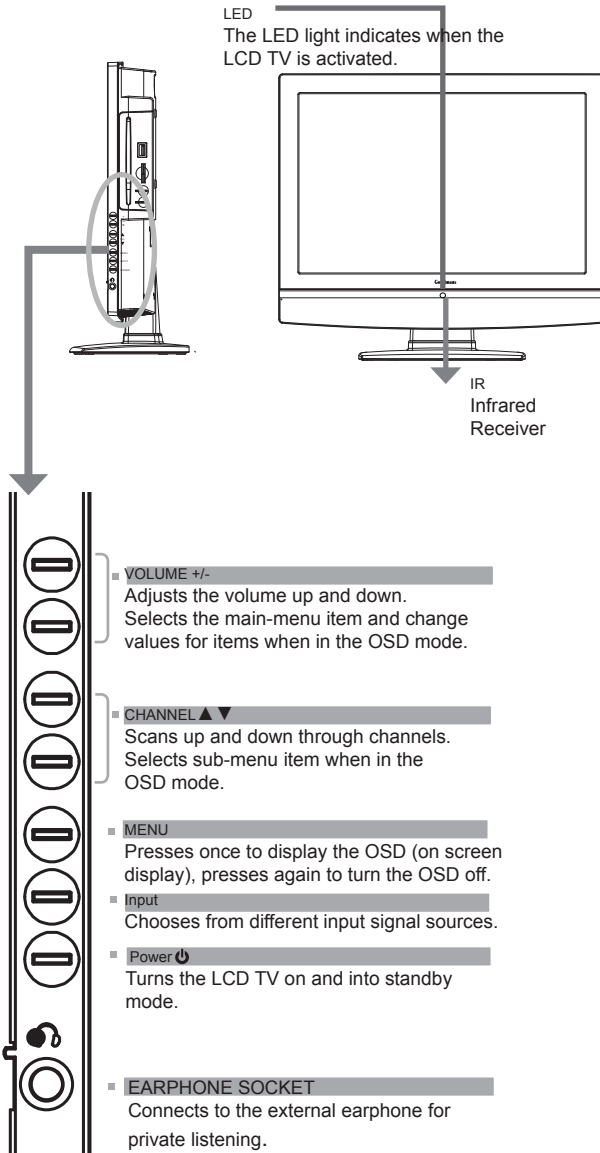

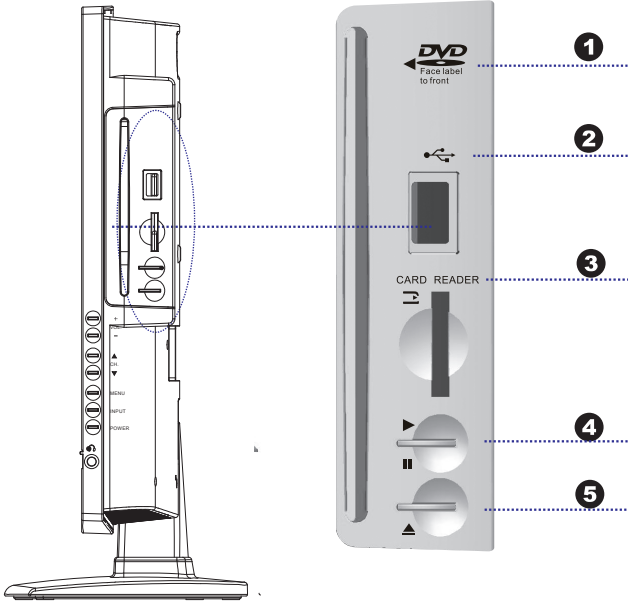

| ITEM                    | DESCRIPTION   |
|-------------------------|---|
| 1. SLOT-TYPE DVD PLAYER | Any of the following disc types are playable on the DVD player: CD-R, CD-RW, DVD-R, DVDRW, VCD, SVCD, DVD+R, and DVD+RW. ( DVD mode ) |
| 2. USB                  | Allow the insertion of a USB disk, You can view digital images or movie playout on your TV. ( DVD mode )                              |
| 3. CARD READER          | Allow the insertion of a SD/MMC card. You can view digital images or movie playout for MPEG1/MPEG2 on your TV. ( DVD mode )           |
| 4. PLAY/PAUSE           | Press to start play back or pause. ( DVD mode )   |
| 5. OPEN/CLOSE           | Press to open and close the disc tray. ( DVD mode )   |

To View USB or SD/MMC card you must select DVD mode then attach/insert USB/SD Card. Using the remote control to navigate and to select the file shown on the TV screen within the SD/MMC Card or USB memory disk/stick. Use the arrow/navigation buttons to rotate any JPEG / MPEG1 / MPEG2 / MPEG4 pictures.

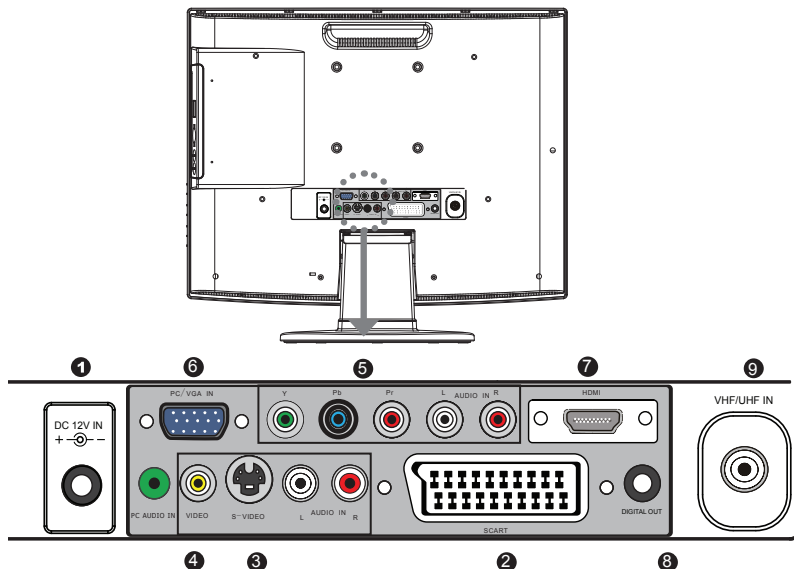



| ITEM                            | DESCRIPTION  |
|---------------------------------|--|
| 1 DC 12V IN                     | Connects to a wall outlet via the included power adapter.  |
| 2 AV1<br>SCART                  | Connect to external equipment with scart socket. This scart input allows audio and CVBS/YC/RGB+CVBS. RGB,S-VIDEO from an external devise to be shown on your TV. |
| 3 AV2<br>S-VIDEO/AUDIO<br>(L/R) | Connects to the S- VIDEO output sockets and Audio output sockets on your video equipment.  |
| 4 AV3<br>VIDEO/AUDIO(L/R)       | Connects to the composite A/V output sockets on your video equipment.  |
| 5 AV4<br>Y, Pb, Pr /AUDIO(L/R)  | Connects to the component ( Y, Pb, Pr ) video sockets and audio ( L/R ) sockets of your DVD player, HDTV, or video equipment.                                    |
| 6 AV5<br>VGA IN/PC AUDIO IN     | Connects to a PC or other devices with a VGA interface.  |
| 7 AV6<br>HDMI IN                | Connects to devices with a HDMI interface.   |
| 8 DIGITAL OUT                   | Connects to digital out socket on external digital audioequipment. (Only for DVB-T / DVD input sources)  |
| 9 VHF/UHF IN                    | Connect TV aerial here.  |



S-VIDEO and Video have a common audio input, if both devices are being used at the same time audio from both will be heard at same time. Only switch on the required device to stop the mixing of audio.



## Your Remote Control



- 1  Turn the LCD TV on and into standby mode.
- 2  Mute and restore your LCD TV sound.
- 3 **ATV/DTV/DVD**  
Press enter ATV DTV or DVD Mode.
- 4 **0-9**  
Select and switch to a channel by using 0-9 buttons.
- 5 **GUIDE/ +10**  
Press this button displays the electronic program guide on the screen.(For DVD model)  
Press this button twice to select song number when the number over 9. ( For DTV mode )

- 6 **CH. +/-**  
Change the channels up and down.

- 7 **VOL. +/-**  
Increase and decrease volume.

- 8 **SLEEP**  
Set the LCD TV sleep time.  
- Press the SLEEP Button to select the number of minutes, followed by 15, 30, 60 minutes and off. The timer begins to count down from the number of minutes selected.  
- To check the remaining sleep time, press the SLEEP Button once.  
- To cancel the sleep time, repeatedly press the SLEEP Button until the display off appears.  
- If you turn the set off after setting the sleep timer, the setting will be erased.

- 9    
  - ◀◀ Press to skip to the beginning of the currently played chapter or track. ( DVD mode )
  - ▶▶ Press to skip to the beginning of the next chapter or track. ( DVD mode )

- 10    
Use to advance or reverse playback rapidly. (DVD mode )

- 11   
▶/|| Press to start playback or pause. ( DVD mode )

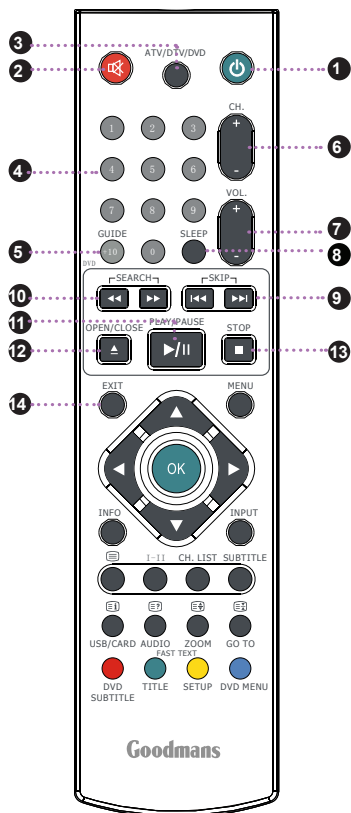

- 12   
▲ Press to open and close the disc tray. ( DVD mode )

- 13   
■ Press to stop playback. ( DVD mode )

- 14 **EXIT**  
Exits the OSD ( On Screen Display ) menu.

- 15 MENU**  
Displays the OSD ( On Screen Display ) menu.

- 16**  Allow you to move, select, and set up the OSD options.

- 17 INFO**  
Press once displays a variety of information such as the current channel and the input source.  
**Browse the disc's information. ( DVD mode ) In DTV mode shows programme information**

- 18 INPUT**  
**Cycle among the different input signal sources:**  
TV → DVD → AV1(SCART) → AV2(S-VIDEO) → AV3(CVBS) → AV4(YPbPr) → AV5(VGA) → AV6(HDMI) → DTV

- 19**  Turn on and off the Teletext function.

**I-II ( NICAM )**  
Cycle through the TV Sound options:  
MONO / DUAL / STEREO.

**CH.LIST**  
Display all channel list&name.

**SUBTITLE**  
Press the SUBTITLE key to display the subtitle which is broadcast with the program on the screen.

- 20**  **USB / CARD**  
Display the main index in Teletext mode.  
Press this button to switch between DVD, Card Reader, and USB memory disk/stick. ( DVD mode )

 **/AUDIO**  
Reveal hidden information such as the answer to a quiz in Teletext mode.  
Change the audio language or audio channel. ( DVD mode )

 **/ZOOM**  
Display the top, bottom or all of page, to easily read in Teletext mode.  
Zoom in/zoom out the displayed frame. ( DVD mode )

 **/GO TO**  
Freeze a multi-page passage on screen in Teletext mode.  
Play from the desired location. ( DVD mode )

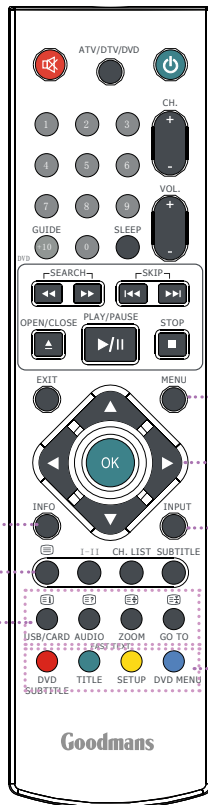

- 21**  **FAST TEXT**  
Access the TELETEXT items or corresponding pages.  
**DVD SUBTITLE**  
Press to activate and change the subtitling feature.(DVD MODE)  
**TITLE**  
Press the button to display the DVD title content. (DVD MODE)  
**SETUP**  
Press to call up setup menu screen. (DVD MODE)  
**DVD MENU**  
Press the button to display the DVD disc menu. (DVD MODE)

## Chapter 2

# Installing the LCD TV

Refer to the owner's manual of any external equipment to be connected.

When connecting any external equipment, do not connect any AC power cords to wall outlets until all other connections are completed.

### Connecting Aerial

#### Antenna Connection

The aerial requirements for good digital reception are more important than for analogue reception. For this reason, a good quality outdoor high gain digital aerial is strongly recommended.

The Power button on the front panel and also on the remote control is only used for powering up and switching the TV to standby mode, it does not disconnect the device from the mains supply.

To completely disconnect the main voltage, please remove the power plug from the socket

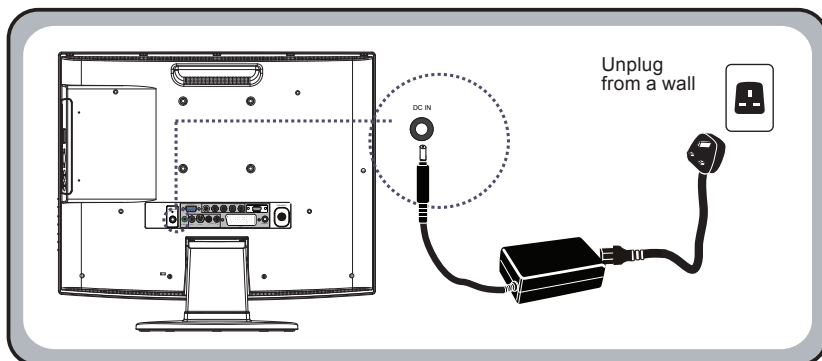
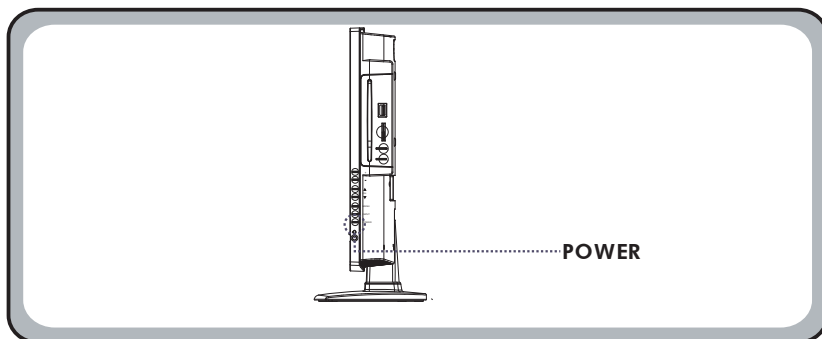

Refer to the owner's manual of the external equipment to be connected. When connecting external equipment, do not connect any AC power cords to wall outlets until you have completed all the connections.

#### Basic Connection: Connecting an aerial

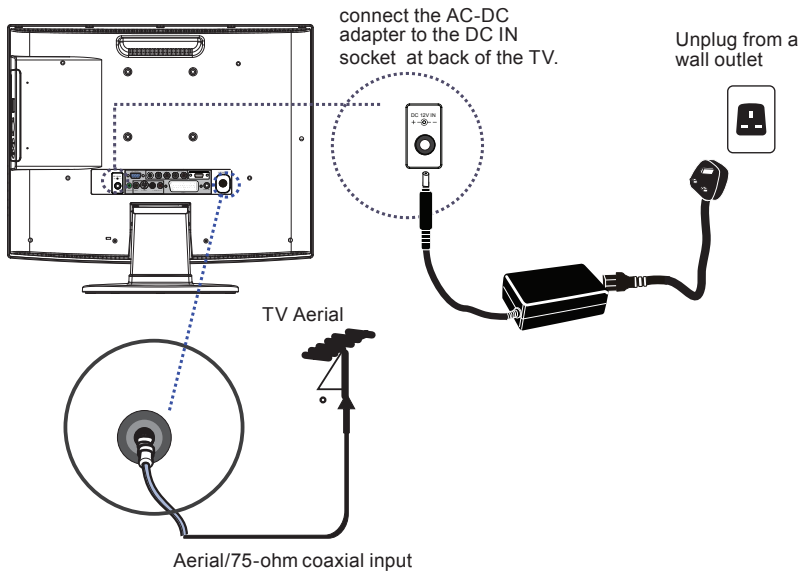

- 1 Connect your existing TV aerial to the Aerial input socket on the TV.
- 2 Connect the AC adaptor to the DC input socket located on the rear panel of the TV as shown above.
- 3 Connect all AC power sources before turning on the TV.
- 4 Press the POWER button on your remote to turn on your LCD TV.
  - a. After connecting an aerial to your LCD TV and connecting the mains cable to the TV and 230VAC mains socket, a blue light will show on the front centre panel of the TV.
  - b. Press the POWER button, the red light will change to green and the First Time Installation screen will show:
    1. Make sure an aerial is fitted then press OK button on the remote to start the Auto Programme Scan (APS).
    2. In a short while you will see the TV programmes briefly as each channel is received and stored in the memory. When APS is completed BBC1 will show, press CH+/- buttons to view the other channels stored.
  - c. To power off press the POWER button, the green light will change to red.
- 5 Press the INPUT button and choose TV or DTV mode then press OK to select.



## Connecting a VCR&Video Camera

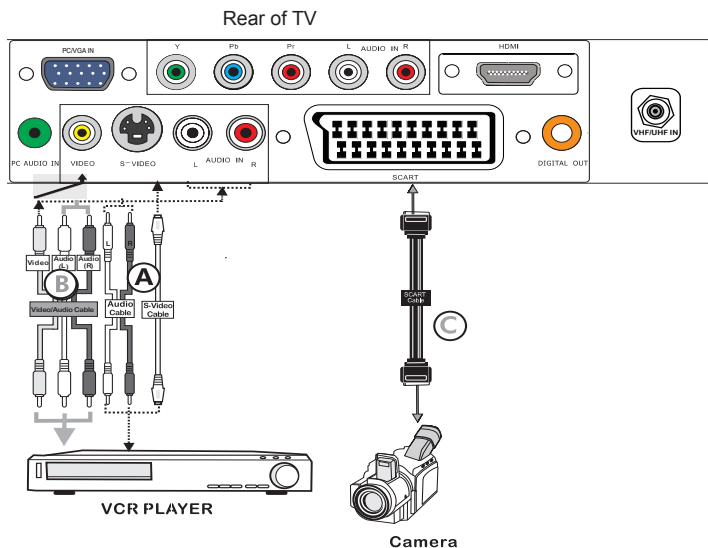

- 1** **METHOD A (AV2)**  
 Use an Audio cable to connect the VCR's/ the Video Camera's audio output sockets to your LCD TV.  
 Use a S-Video cable to connect your LCD TV and VCR player/ video camera.

**METHOD B (AV3)**  
 Use an A/V cable to connect the VCR's/ video camera's composite output sockets to your LCD TV.

**METHOD C (AV1)**  
 Use a SCART cable to connect the VCR's SCART socket to the LCD TV 's SCART socket.
- 2** Connect all power sources before turning on the LCD TV or other connected equipments.
- 3** Press the POWER button to turn on your LCD TV.
- 4** To watch video camera, press the INPUT button to select AV2 or AV3.
- 5** To watch VCR, press the INPUT button to select AV1, AV2 or AV3 .

**!** "Not all cameras have the ability to connect to a TV. Please check your video camera user guide for compatibility".

## Connecting a TV Cable Box or Satellite Receiver

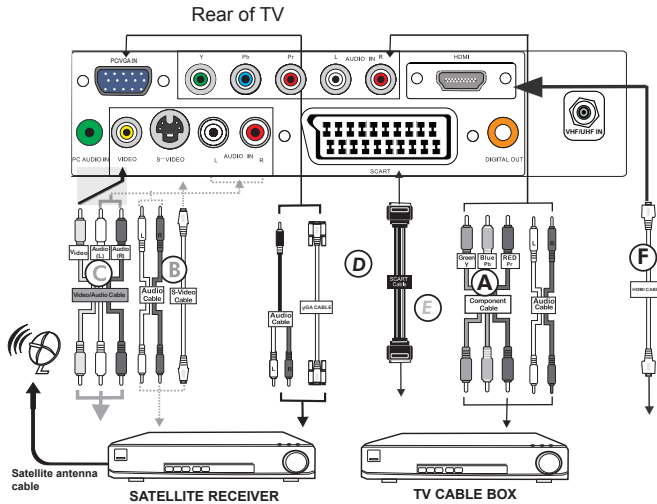

- 1** Method A(AV4) :

Use a Component cable to connect the Y/Pb/Pr sockets on the TV Cable Box to your LCD TV.

Use an Audio cable to connect TV cable box's audio output sockets to LCD TV.

Method B(AV2) :

Use an Audio cable to connect the TV Cable Box's audio output sockets to your LCD TV.

Use a S-Video cable to connect your LCD TV and TV Cable Box.

Method C(AV3) :

Use an AV cable to connect the TV Cable Box's composite output sockets to your LCD TV.

Method D(AV5) :

Use a VGA 15 pins cable to connect the TV Cable Box's RGB output sockets to your LCD TV.

Use a 3.5mm socket to RCA adapter cable for connecting audio.

Method E(AV1) :

Use a SCART cable to connect the TV Cable Box's SCART socket to the LCD TV's SCART socket.
- 2** Method F(AV6) :

Use a HDMI cable to connect the Satellite Receiver HDMI connector to your LCD TV.
- 3** Connect all power sources before turning on the LCD TV or other connected equipments.
- 4** Press the POWER button to turn on your LCD TV.
- 5** To watch TV cable box, press the INPUT button to select AV1, AV2, AV3, AV4, AV5.
- 6** To watch programs satellite receiver, press the INPUT button repeatedly to select AV6.

## Connecting an Audio Amplifier

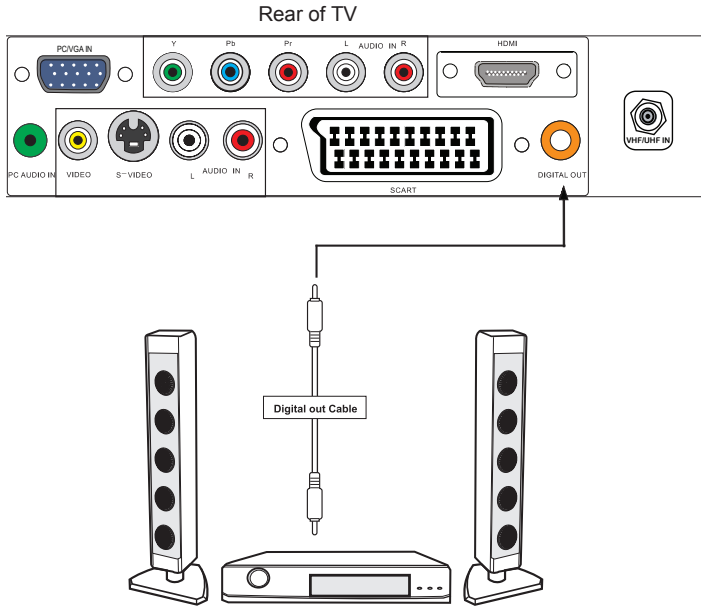

- 1** Use An RCA cable (you can use the supplied Video cable) to connect the audio receiver's digital coaxial Input to LCD TV 's DIGITAL OUT sockets.(Only for DVB-T / DVD input sources)
- 2** Connect all power sources before turning on the LCD TV or other connected equipments.
- 3** Press the POWER button to turn on your LCD TV.

# HDMI

- This TV can accept High-Definition Multimedia Interface(HDMI) .
- This TV SET supports HDCP(High-bandwidth Digital Content Protection) Protocol for TV SET (480p, 720p, 1080i) modes.
- When you connect to the output of an HD ready player (DVD Player, Set Top Box or PC) switch to the AV6(HDMI) function and the TV will automatically detect the resolution used by the HDMI source.
- To get the best picture quality, adjust the DVD Player or Set Top Box output resolution to 1280 x 720p.
- To get the best picture quality, adjust the PC graphics card to 1024 x 768, 60Hz.

## How to connect

1. If Source Devices have HDMI Output , connect to the HDMI socket located at the rear of the TV using the HDMI Cable supplied with your external devise. (HDMI sends Digital Video and Audio with one cable.)

Cable sample



HDMI Cable  
(not supplied with the product)

# Chapter 3

## USING THE FEATURES

### Tuning in the TV channels

After powering up connecting an adapter to your LCD TV. The First Time Installation screen will show:

1. Make sure an aerial is fitted then press OK button on the remote to start the Auto Programme Scan (APS).

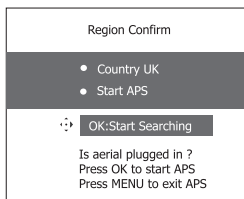

2. In a short while you will see the TV programmes briefly as each channel is received and stored in the memory. After analogue stations have been located and stored into the memory, the digital tuning scan will commence. Press the OK button to start the scan. When APS is completed BBC1 digital TV will show, press CH+/- buttons to view the other channels stored. To view analogue or digital TV press INPUT button and use the up / down arrow buttons to select DTV or TV and then Press the OK button. Change channels by pressing the CH +/- buttons.

To power off press the POWER button, the green light will change to red.

### Selecting a INPUT

Press the INPUT button to display the function required (TV/AV). Using the arrow buttons on the remote highlight the function required and press the OK button to select the function.

### Select TV Channel

Press the CH.+/- button on the remote control and the CH.+/- button on the LCD TV to change the TV channels.

You can directly select the TV channel required by pressing 1, 2 or 3 etc on the remote button pad.

### Adjusting the Volume

Press the VOL. +/- button on the remote control or the VOL. +/- button on the LCD TV to adjust the volume.

### To Mute the Sound

Press MUTE and the sound cuts off.

To turn mute off, press the MUTE button again, or simply press the VOL +/- button.

### Sleep Timer

Press the SLEEP button continuously to select the sleep timer or turn the sleep timer from the OFF, 15, 30, 60 minutes; when the LCD TV has reached the set time, it will automatically turn off. If the TV has no INPUT signal, it will automatically power down to standby after 15 minutes.

## OSD Menu Operation

1 The main menu provides access to the following menus:

|                  |   |
|------------------|---|
| Video            | Adjust picture setting such as picture mode, contrast, brightness, sharpness colour and advanced.   |
| Audio            | Adjust sound option and effects.  |
| Setup            | Adjust colour standard, sound standard, APS, Manual search, Channel setup.  |
| Preferences      | Adjust preferences such as OSD, blue screen, childlock, sleep timer, OSD timer, OSD reset.  |
| Screen           | Adjust screen such as horizontal size, horizontal position, vertical position, phase, auto sync.  |
| DTV (Digital TV) | The DTV menu provide four submenus as follow: edit channel list, configuration, parental control, EPG (Electronic Programme Guide), with which you can set the DTV as you wish. |



2 Press the MENU button on the remote control. The main menu will appear on the screen.

3 Use ◀/▶ to highlight your main menu option, then press OK to enter your selected option.

Use ▲/▼ to highlight an option of the sub-menu. Use ◀/▶ to change the value of the item. Press the EXIT button to exit menu.

### VIDEO

Use this Video setting menu to adjust the picture quality which best corresponds to your viewing requirements. The Video Menu includes the following options:

| OPTION       | DESCRIPTION   |
|--------------|---|
| Picture Mode | Custom: Select for user's settings. The items of video can be adjusted when the picture mode is for user's settings except advanced item. |
|              | Vivid: Select for enhanced picture contrast and sharpness.  |
|              | Standard: Select for standard picture settings. Recommended for home entertainment.   |
|              | Mild: Select for mild picture settings.   |
| Contrast     | Adjust the difference between the brightness and darkness regions of the picture.   |
| Brightness   | Adjust to increase or decrease the brightness.  |
| Colour       | Allows to adjust the colour from 0 to 100.  |
| Tint(NTSC)   | Allows you to adjust the color tint of the picture. (Only for NTSC)   |
| Sharpness    | Adjust to sharpen or soften the picture.  |

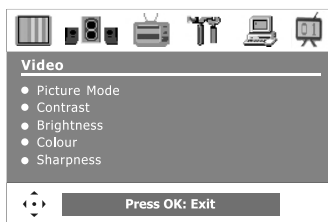

## The VIDEO Settings

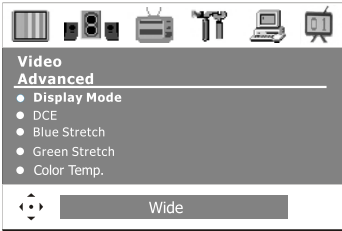

| OPTION   | DESCRIPTION   |
|----------|---|
| Advanced | Display Mode Allows you to select the display mode to be Wide, 4:3,Original, Zoom.    |
|          | DCE Allows you to adjust the (Dynamic Contrast Enhancemen) to be off, low, mid, high. |
|          | Blue Stretch Allows you to adjust the blue stretch.                                   |
|          | Green Stretch Allows you to adjust the green stretch.                                 |
|          | Color Temp. Allows you to adjust the color temp. to be cool, warm , standard.         |

## AUDIO

Use this AUDIO setting menu to adjust the sound and balance and volume to your listening requirements.

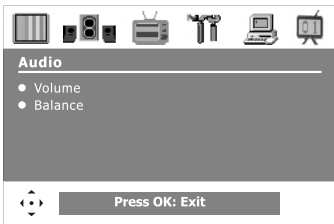

| OPTION  | DESCRIPTION  |
|---------|--|
| Volume  | presets the volume to a given setting.             |
| Balance | Adjust to emphasize left or right speaker balance. |

## The Setup Settings(Analogue TV)

Setup menu is only available when viewing Analogue TV. Use this Setup menu to select Colour Standard, Sound Standard, APS, Manual Search, Channel Setup. Use the Up/Down arrow buttons to highlight the required setting. Press the Press OK button to select the function. Use left / right arrow buttons to adjust the settings. Press OK to save the adjustment.



| OPTION          | DESCRIPTION  |
|-----------------|--|
| Colour Standard | Allows you to select the colour standard : AUTO,PAL, SECAM, UK = PAL.                        |
| Sound Standard  | Allows you to select the sound standard : DK, BG, I, L/L'.                                   |
| DK              | PAL D/K, SECAM D/K (East Europe / China )  |
| BG              | PAL B/G, SECAM B/G (Europe / East Europe / Asia / New Zealand / M.East / Africa / Australia) |
| I               | PAL I (U.K. / Ireland / Hong Kong / South Africa)  |
| L/L'            | SECAM L/L'   |



**APS**  
Press OK to start Auto Search and auto sort process. Note: Auto Sort will only operate in UK.  
**Country**  
Allows you select the country :Austria, Belgium, Switzerland, Czech Rep., Germany, Denmark, Spain, France, Finland, UK, Greece, Hungary, Italy, Norway, Netherlands, Portugal, Poland, Sweden, Slovenia, Slovakia, Turkey, Others.

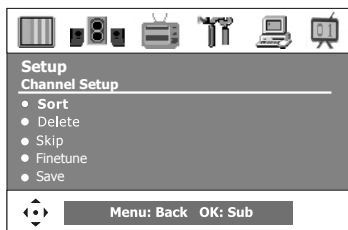

**Manual Search**  
Allows you to adjust the manual search by hand if signal is too weak or picture is blurry.

**Channel Setup**  
Press the ► button to select Sort, Delete, Skip, Finetune, Save.

|          |   |
|----------|---|
| Sort     | Allows you to manually sort the stored programme. |
| Delete   | Allows you to delete the stored programme.        |
| Skip     | Allows you to skip the stored programme.          |
| Finetune | Allows you to finetune the stored programme.      |
| Save     | Allows you to save the setup.                     |



## The Preferences Settings

Use this Preferences setting menu to set up some features: OSD, Blue Screen, Childlock, Sleep Timer, OSD Timer, OSD Reset.



| OPTION      | DESCRIPTION   |
|-------------|---|
| OSD         | Language : Allows you to select the OSD to be English, French, Spanish, German, Italian, Portugese, Dutch, Polish, Russia. Transparency: Allows you to adjust transparency from 0 to15. |
| Blue Screen | Allows you to select the blue screen to be off or on.   |
| Childlock   | Allows you to select the childlock to be yes or no. (Default password is 0000. golden password is 3796.)<br>Change Pin: Allows you to change the 4-digit password.                      |
| Sleep Timer | Allows you to select the sleep timer to be off, 15min, 30min, 60min.  |
| OSD Timer   | Allows selection of the display time of the on-screen menu:5 s,10 s,15 s, 20 s, 25 s.   |
| OSD Reset   | Allows you to restore the factory settings.   |

### SCREEN(Only for VGA)

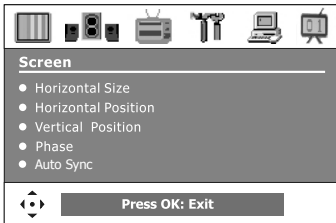

| OPTION              | DESCRIPTION  |
|---------------------|--|
| Horizontal Size     | Allows you to adjust the Horizontal Size from 0 to 100.      |
| Horizontal Position | Allows you to adjust the Horizontal Position of the picture. |
| Vertical Position   | Allows you to adjust the Vertical Position of the picture.   |
| Phase               | Allows you to improve focus clarity and image stability.     |
| Auto Sync           | Allows to auto synchronize VGA signal.                       |

## Chapter 4 Using the DTV OSD Settings



| OPTION              | DESCRIPTION  |
|---------------------|--|
| Edit Favourite List | Create, Modify or delete a channel list. Lock some channels that are not suited for younger members of the family, skip/add the channel list as. |
| Configuration       | Add new channel, set audio language, subtitle language, as you wish. Upgrade the system. View the signal information.                            |
| Parental Control    | Enable or Disable the menu protection system and allows the PIN code to be changed.  |
| EPG                 | Electronic Program Guide   |

### EDIT FAVOURITE LIST

Highlight the Edit Favourite List option, then press OK button, there are three items in the menu.

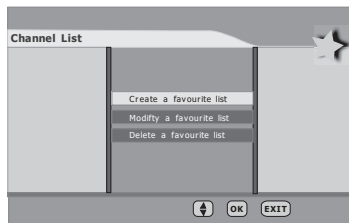

#### CREATE A FAVOURITE LIST

Highlight the Create a favourite list item, pressing OK button, then The menu is displayed on the screen now. Once you enter the Create a favourite list menu, a new channel list will be created, you can create four favourite lists at most.

You can lock or unlock the selected channel by pressing the RED button, pressing the BLUE button to skip or add the selected channel. If you want to skip or add all, first press the GREEN button, then press either the RED button to skip all, or the GREEN button to add all. A channel selected as a locked appears in the channel list with a lock icon ( red button ) against the channel name, a channel selected as a added appears in the channel list with a add icon ( tick ) against the channel name.

## Using the DTV OSD Settings



By pressing the YELLOW button you can sort the channels in the list. Then you can sort the channels alphabetically by pressing the RED button or sort the channels manually by pressing the BLUE button. If you have locked several channels, by pressing the YELLOW button, the locked channels will be placed at the bottom of the Channel list in alphabetical sort.



When you complete the edit, press the EXIT button to quit the favourite channel list menu. The next menu will ask if you want to save the changes you have made, using the ◀/▶ buttons to highlight the YES option, and press the OK button to save the changes.

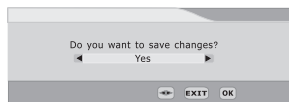

Once you lock a channel, you must enter the PIN Code that is set in the parental control menu at first before the channel is displayed.

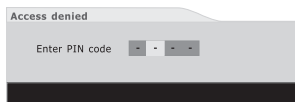

If you skip a channel, it cannot be shown in the list menu ( Press OK button will pop-up the favorite channel list menu when you watch the digital terrestrial television ) unless you add it again. ( In the channel list menu, the skipped channel name is not shown.)

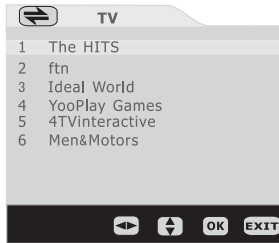

### MODIFY A FAVOURITE LIST

You can modify the favourite list which you have create. The list named "TV / RADIO" is the default list, the rest are created. Select a favourite list, then press OK button to modify the list as you do in the create a favourite list menu.



### DELETE A FAVOURITE LIST

Using the ▲/▼ buttons to highlight the list name which you want to delete, then pressing the OK button to delete the favourite list, the pop-up menu will ask if you confirm or cancel the delete operation. ( Note: The default favourite channel list name isn't displayed in the list, so you can only delete the list name you created.)



## Using the DTV OSD Settings

### CONFIGURATION

Highlight the Configuration option, then press OK button to enter the selected option. The configuration menu is displayed on the screen now.

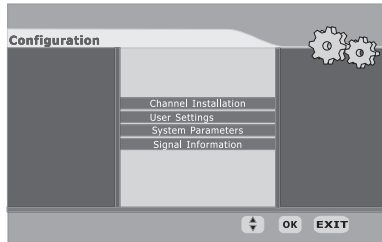

### CHANNEL INSTALLATION

Use these options if you have moved location or want to rescan for new channels. Press OK button to display the channel installation menu.

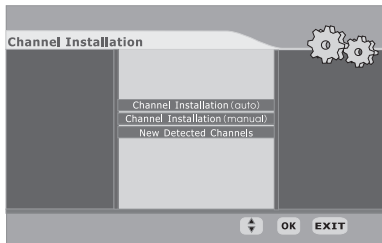

If you want the TV to auto search the channels, press OK button to continue. Then you should choose the installation type by using the ◀/▶ buttons and press the OK button to start the installation process. If you choose 'add', the new channels will be added in the channel list. If you choose 'new', the new channels will replace the previous channels in the channel list.

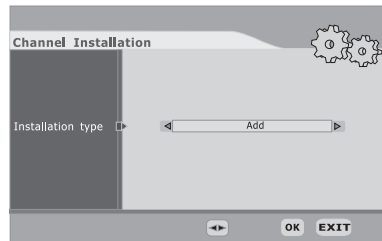

## Using the DTV OSD Settings

If you want to install the channels by yourself, using the ▲/▼ buttons to highlight the channel installation (manual) option, and press ok to install manually. First you should choose the installation type, then you can see the following menu. Using ◀/▶ to cycle the channel option, then the bar graphs of signal level and signal quality will indicate whether any channels are likely to be found. You should choose the channel of which the signal quality bar is high as well, then press OK button to scan the channels.

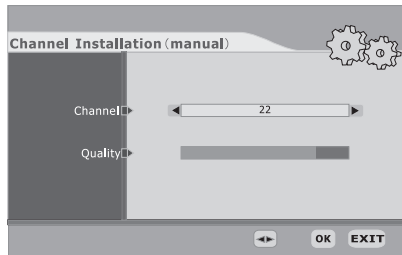

### NEW DETECTED CHANNELS

The New Detected Channels menu shows the channels that you add in the channel list recently. The type icon of the program is displayed against the channel name.



## Using the DTV OSD Settings

Using the ▲/▼ buttons to highlight the user settings item in the configuration menu, then press OK button to display the user settings menu.



### AUDIO LANGUAGE

This function selects which language soundtrack you will hear when switching to a channel broadcasting with multiple soundtracks. Highlight the audio language line in the user settings menu and use ◀/▶ buttons to cycle through the language options.

### SUBTITLE LANGUAGE

This function selects the desired subtitle language whenever subtitle information is broadcast. Highlight the subtitle language line in the user settings menu and use ◀/▶ buttons to cycle through the language option.

### SYSTEM PARAMETERS

Using the ▲/▼ buttons to highlight the system parameters item in the configuration menu, then press OK button to display the system parameters menu.

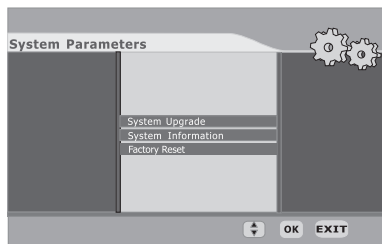

### SYSTEM UPGRADE

Highlight the System Upgrade item in the system parameter menu, pressing OK button to display the System Upgrade menu. press OK button to upgrade system. If there is a new software, the unit will upgrade itself.

## Using the DTV OSD Settings

### SYSTEM INFORMATION

Highlight the system information item in the system parameter menu, pressing OK button to display the system information menu. You can view the system information in this menu, however, you can modify nothing in this menu, Pressing OK button to quit.

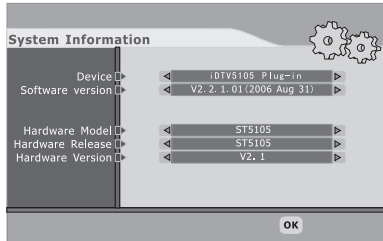

### SIGNAL INFORMATION

Highlight the Signal information item in the configuration menu, pressing OK button to display the Signal information menu. Cycle through the channel option by using the ◀/▶ buttons on the remote control. The signal level and signal quality of the channel that offers the upgrade software can be observed on the two bar graphs. The bar graphs of signal quality and signal level give a good indication of whether the selected channel is likely to be found. If the signal quality bar is high as well then it is a digital frequency and digital channels will probably be found.

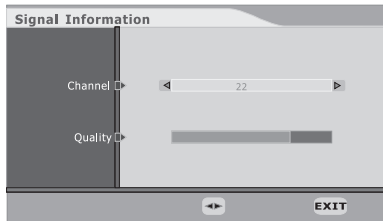



## Using the DTV OSD Settings

### PARENTAL CONTROL

Highlight the parental control line in the parental control menu and use ◀/▶ buttons to cycle through the enable and disable option. Toggle this option to enable, then the following items can be altered.



### RECEIVER LOCK

You should enter the PIN CODE before you can see the DTV program while you power on the TV and select the DTV INPUT.

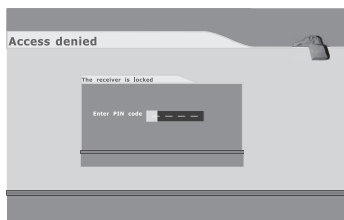

### CONFIGURATION MENU

If you toggle this option to YES, you will enter the PIN CODE before enter the configuration menu.

### CHANNEL LOCK

If you toggle this option to YES, the channels you locked in the edit channel list menu can't be displayed before you enter the PIN CODE.

### MATURITY LEVEL

There are 18 levels total. If you toggle this option to a number (1-18), for example, you toggle it to 15, that's to say, if the channels broadcast material is not suitable for the family members who are under 15 years old, you must enter the PIN CODE before you can view them. (The maturity level information should be broadcast with these programs.)

## Using the DTV OSD Settings

### PIN CODE CHANGE

Pressing the 'RED' button will popup the PIN code change menu, enter the previous code by using the 0-9 buttons on the remote control, then enter the new code twice to confirm and this menu will disappear (The PIN is factory set to 0000). Pressing EXIT to quit without saving the new code.

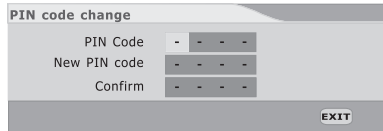

Pressing OK button to quit the parental control menu with saving these alteration. Pressing EXIT button to quit the parental control menu without saving these alteration.

Note: If you forgot the code which you set it, you can press RED-RED-GREEN-GREEN-YELLOW-YELLOW-BLUE-BLUE button to enter the PARENTAL CONTROL SUB-MENU to change the new code

### EPG

EPG (Electronic Programme Guide) menu is reached by pressing GUIDE button, quit by pressing GUIDE button again. Current program is highlighted. Use Channel Up/Down ▲/▼ buttons to change channels and view the other programmes on the selected channel. Press the Arrow up / Arrow down navigation buttons to scroll through and show programme content. There is a 7day EPG, you can see the other days channel list by using Left / right navigation arrow ◀/▶ buttons.



The short description of the highlighted channel is shown under the image window, and you can see the extended description by pressing the INFO or OK button and by pressing this button again you can close this window. Press "RED" button to set a Reminder to automatically view a chosen channel. by pressing this button again you can cancel this reminder.



## Using The Built-In DVD

### TO INSERT A DISC

Select DVD function before inserting the disc to the player.

Plays movies and other content on DVD, VCD, SVCD, and audio CD.

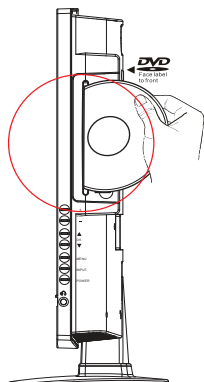

Note:

Insert a disc with label side facing to front of TV

### TO REMOVE A DISC

When removing the disc, do not attempt to pull it from its slot. Please push the  Button .

1. Turn your LCD TV on.
2. Select INPUT to DVD.



3. Insert a disc with label side facing front of TV ( CD-R, CD-RW, DVD-R, DVDRW, VCD, SVCD, DVD+R, or DVD+RW )
4. After the disc is inserted, Smart NAVI will show the contents of the disc automatically.
5. If DVD cannot automatically play, press ▲/▼ or ◀/▶ Button to select play content, and press OK Button or PLAY/PAUSE ▶/■ Button on the remote control to the start playing content.

## Using The Card Reader & USB

The Smart NAVI Viewer allows you to play JPEG / MPEG1 / MPEG2 / MPEG4 files in a SD storage card on your LCD TV.

### TO INSERT A SD CARD

Be sure to insert the SD card in the correct orientation. If the SD card is forced in the wrong way, it may cause damage.

### TO REMOVE A SD CARD

When removing the SD card, please pull it from its slot.

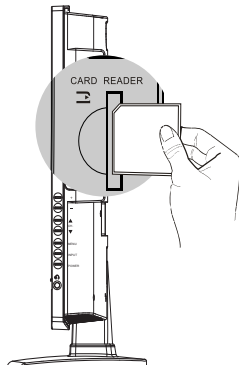

1. Turn your LCD TV on.
2. Select INPUT to DVD.
3. Insert a SD card that contains JPEG / MPEG1 / MPEG2 / MPEG3 / MPEG4 files.
4. Press "CARD" Button on the remote control to enter Card Reader Mode.
5. Press ▲/▼ Button on the remote control to select the file you want to play, and then press "OK" Button to play the file.

### NOTE:

1. The card socket and the DVD player cannot be used simultaneously, so please insert either a card or a disc, not both at once.
2. If you want to view the DVD program or turn USB file on, please press "USB/CARD" Button to switch it.

### USB ( Universal Serial Bus )

Insert a USB disk memory stick or plug, and press USB/CARD button to switch to USB playing status. The TV screen will show the USB menu.

The playing interface and operation methods are alike MP1 / MP2 / MP3 / MP4 and JPEG files. The playing interface is according to the content of your saving.

## Using The Card Reader & USB

---

### PLAYING BACK DVD / USB / CARD

For trouble free operation of SD CARD/USB or DVD disc play. Please ensure that the following steps are taken before inserting an SD card, USB or DVD disc:

#### DVD Playback

1. Press INPUT Button and select DVD / USB / CARD function.
2. Allow 10 seconds before inserting a DVD disc ensuring that the label side is facing you.

#### SD CARD/USB Playback

1. Press the INPUT Button and select DVD / USB / CARD function.
2. Press the USB/CARD Button on the remote.
3. Now Insert a Card ( Label side facing you ) or USB cable.

Note: If DVD has been previously played its important that the disc is removed and that the USB/CARD Button on the remote is pressed before inserting a card or USB cable. Failure to do so will result in the card/USB failing to be read and shown on the monitor.

#### DVD Supports following formats:

1. ( CVR/VBR ) bite rate range : 32kbps~320kbps.  
WMA bite rate range: 64kbps~192kbps ( Sample Rate )
2. JPG picture maximum resolution:  
Baseline JPG: 3072X2048  
Progressive JPG: Width x ( High+128 )<3300000
3. MPEG4:  
Version: DivX3. 11 / DivX4.xx / DivX5.xx / DivX6.0,  
Video Input resolution: PAL<=720x576, NTSC<=720x480.
4. \*.MPG, \*.DAT MPEG1 video format, same as VCD.

## SEARCH PLAY

---

### For DVD discs:

Press the GO TO key on the remote control in normal playing status to display on screen as follows:

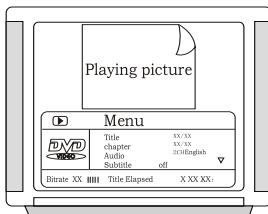

Use the arrow buttons and number keys to adjust the following:

- |                   |                        |
|-------------------|------------------------|
| 1. Title          | 5. Time of the Title   |
| 2. Chapter        | 6. Time of the Chapter |
| 3. Audio          | 7. Repeat On/Off       |
| 4. Subtitle Angle | 8. Time Display Mode   |

Both VCD and DVD discs share the same instructions.

### For CD discs

Press the GO TO key on the remote control the screen will display as following order:

Track 03/71                      05:33

Disc Go To - - :- -

Track Go To: - :- -

Select track: - :- -

## WMA Playback

### WMA Playback

---

The DVD player can playback discs, including CD-R, CD-RW, DVD-R, DVD-RW,DVD+R, or DVD+RW recorded with audio files. Multiple and multi-level directories are also supported.

Upon loading a WMA disc , the screen shows a menu as :

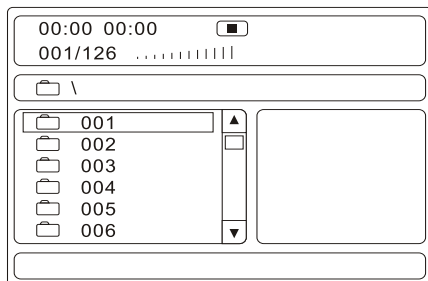

## WMA Playback

---

To access your preferred directory, use the up/down ( ▲/▼ ) cursor keys to select the file, and press OK key to confirm.

Use the up/down ( ▲/▼ ) cursor keys to select song and press OK Button to start playing. Press left cursor button to return to the previous directory, you can then select other directories.

## Picture CD Operations

### Playing Kodak Picture CD or JPEG files

---

The DVD player is compatible to Kodak Picture CD and discs containing JPEG / MPEG1 / MPEG2 /MPEG4 image files ( with .JPG file extension ). This function is similar to playback function.

Upon loading a Kodak Picture CD JPEG files, TV screen will display the following :

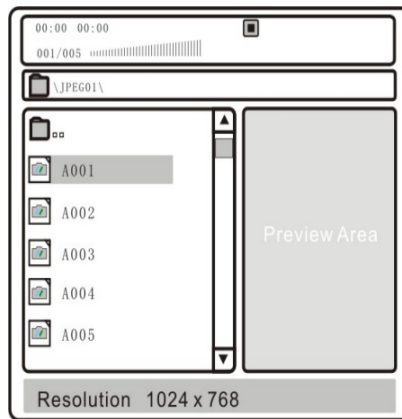

Operations:

#### Picture selection & Preview:

Press cursor buttons to select the target picture and press OK Button to show. The player will show the preview of the picture in preview area once the cursor stops.

#### Rotate Picture:

You can use arrow left/right buttons to rotate current showing picture.

## Picture CD Operations

---

### Previous and Next selection:

---

You can press ◀◀ Button to show previous picture or ▶▶ Button to show next picture manually.

### Slide Show:

---

The player will automatically play pictures in slide show mode if the disc containing more than one picture. There are 16 available modes to wipe the TV screen when displaying a new picture:

Press up/down ( ▲/▼ ) cursor keys to change the current slide show mode when playing pictures.

## MPEG 4 Operations

### MPEG-4 Playback

---

Upon loading the disc, the screen shows a window as follows: ( The following picture just for reference only )

1. Choose your preferred directory, use the ▲/▼ Buttons to navigate and then press the OK Button to confirm.

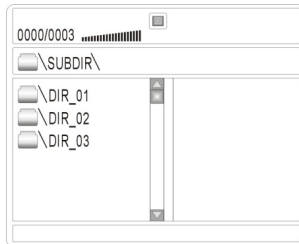

2. Select the AVI file by using cursor button to choose the preferred AVI file and press OK Button to play it.

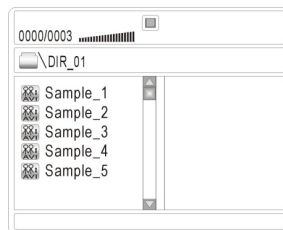

3. Return to the main directory. Press left cursor button and then press STOP Button to return to the main directory, you can then select another directory.
4. To stop playing, press the STOP Button at anytime.



## Using General Setup Page

The setup menu is used for configuring the DVD player.

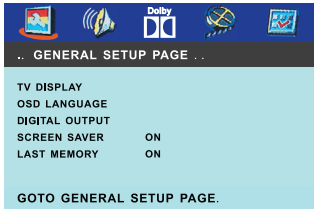

| OPTION         | DESCRIPTION  |
|----------------|--|
| TV DISPLAY     | <p><b>4:3 Pan Scan</b><br/>Select this when the player is connected with a standard format TV set . Widescreen picture shown in the full screen with some part cut.</p> <p><b>4:3 Letter box</b><br/>Select this when the player is connected with a standard format TV set. Widescreen picture shown in the full screen with black bars on the top and bottom of the screen.</p> <p><b>16:9</b><br/>Select when the player is connected to a Widescreen TV set.</p>   |
| OSD LANGUAGE   | <p><b>OSD Language</b><br/>The default language is English. You can select other OSD languages: English / Norwegian / Sweden / Finish / Dainish / Greek / Italian / Polish / Hungarian / Czech / French.</p>   |
| DIGITAL OUTPUT | <p><b>Output</b><br/>There are 3 kinds of SPDIF output mode for choose: SPDIF OFF, SPDIF RAW and SPDIF PCM .</p> <p><b>SPDIF OFF:</b><br/>Set as default, there will be no digital audio signal output.</p> <p><b>RAW:</b><br/>Set as default, the digital audio signal output will be in RAW format. Normally, this mode is used for DTS signal and Dolby digital signal.</p> <p><b>PCM:</b><br/>Set as default, the digital audio signal output will be in PCM format. Normally, this mode is use for audio CD signal.</p> |

## Using General Setup Page

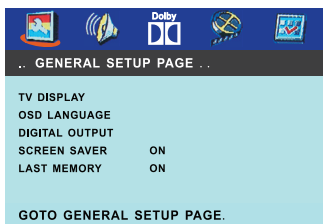

| OPTION       | DESCRIPTION  |
|--------------|--|
| SCREEN SAVER | Screen saver<br><br>When the player stops or the picture becomes motionless for a couple of minutes, there will be a screen saver to prevent damage to the display screen.<br><br>ON: To activate screen saver.<br><br>OFF: To disable screen saver. |

|             |   |
|-------------|---|
| LAST MEMORY | Last Memory<br><br>ON: Each time when you turn off the player, it will memorize the last played file. So if you turn on the player or play the same disc next time, it will resume from the same point.<br>OFF: Disable the last memory function. |
|-------------|---|

## Analogue Audio Setup Page

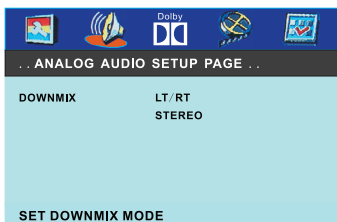

| OPTION  | DESCRIPTION  |
|---------|--|
| DOWNMIX | DOWNMIX<br><br>LT/RT: Select this option when the DVD player is connected to external amplifier with Pro-Logic decoding function.<br><br>STEREO: Press down button to select the stereo, and then press OK Button to confirm it. |

## Dolby Digital Setup

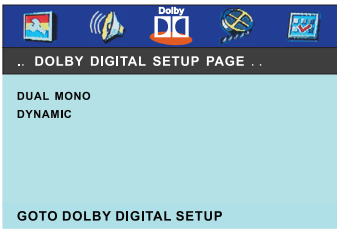

| OPTION    | DESCRIPTION   |
|-----------|---|
| DUAL MONO | <p>Dual Mono Stereo: It means that the player will output Left channel and Right channel audio.</p> <p>L-Mono: It means that the player will output left channel audio only.</p> <p>R-Mono: It means that the player will output right channel audio only.</p> <p>MIX-Mono: It means that the player will output the average signal of the Left channel and Right channel audio.</p> <p>Note:<br/>This setting is used to play Dolby AC-3 encoded 2 channel discs. Some DVDs may not being change in this menu setting.</p> |

|         |  |
|---------|--|
| DYNAMIC | <p>Dynamic</p> <p>When set the dynamic range to FULL, the soft music will be automatically increase, and the loudness of the music will automatically decrease.</p> <p>When set the dynamic to OFF, the function will be disabled.</p> <p>Note:<br/>This setting is used to play Dolby Digital encode disc.<br/>This function is suitable to use at night.</p> |
|---------|--|

## Using Video Setup Page

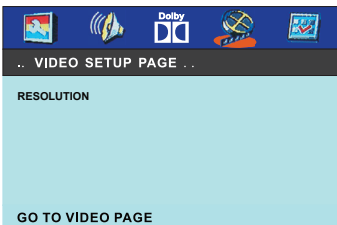

| OPTION     | DESCRIPTION   |
|------------|---|
| RESOLUTION | <p>Allows you to select 480p, 576p, 720p mode. The factory default is 720P.</p> |

## Using Preference Page

The unit must be at complete STOP mode to access to SETUP Preference Page.

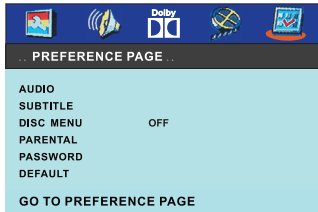

| OPTION    | DESCRIPTION   |
|-----------|---|
| AUDIO     | <p><b>AUDIO</b><br/>Set the audio language to your language of choice: English / Norwegian / Sweden / Finnish / Dainish / Greek / Italian / Polish / Hungarian / Czech / French.<br/>NOTE: Not all DVD discs are recorded with multiple languages.</p>  |
| SUBTITLE  | <p><b>SUBTITLE</b><br/>Select the Subtitle language: English / Norwegian / Sweden / Finnish / Dainish / Greek / Italian / Polish / Hungarian / Czech / French OFF.<br/>NOTE: Not all DVD offer subtitles in multiple languages.</p>   |
| DISC MENU | <p><b>DISC MENU</b><br/>Select the Disc Menu language: English / Norwegian / Sweden / Finland / Dainish / Greek / Italian / Polish / Hungarian / Czech / French.<br/>NOTE: The default language is English.</p>   |
| PARENTAL  | <p><b>PARENTAL</b><br/>Allows the user to set a maximum rating of movie that can be played (e.g. PG rating). Movies rated higher than the level set will not be played. The parental lock can only be changed after input the correct password.<br/>NOTE: This function is available only when the discs have rating encoded on.</p> <p><b>PASSWORD MODE</b><br/>Select to change old password to new password. (Factory default is 000000, and the golden password is 003796)</p> <p><b>PASSWORD CHANGE</b><br/>To change the password, you need to:</p> <ol style="list-style-type: none"> <li>1. Input old password.</li> <li>2. Input a 6-digit new password.</li> <li>3. Input the new password again to confirm.</li> </ol> |
| DEFAULT   | <p><b>DEFAULT</b><br/>To restore all setup parameters to the factory settings EXCEPT the password. This function available in stop state or when the tray is opened.</p>  |

## Troubleshooting



Before consulting Goodmans the Helpline, check the following chart for a possible cause of problem and for a possible solution. HELPLINE NUMBER 0871 230 1777

### TV will not turn on

- 1 Make sure the power cord is plugged in
- 2 The batteries in the remote control may be exhausted.
- 3 Replace new and same brand batteries.

### No picture, no sound

- 1 Check the interface cable between TV and antenna/cable TV.
- 2 Press the POWER button on the remote.
- 3 Press the TV button on the remote, then press INPUT button repeatedly to select the connected video INPUTs.

### Poor picture, sound OK

- 1 Check the interface cable between TV and antenna/cable TV.
- 2 Try another channel, the station may have broadcast difficulties.
- 3 Adjust the Brightness/Contrast options in the VIDEO Menu.

### Picture OK, poor sound

- 1 Sound may be muted. Press the  button on the remote.
- 2 Press the VOL+ button to increase the volume.

### Audio noise

- 1 Move any infrared equipment away from the TV.

# SPECIFICATIONS

|                       |  |
|-----------------------|--|
| Model                 | GTVL19W17HVFW                                    |
| Panel System          | 19 inch LCD panel                                |
| Display Resolution    | 1440 pixels (horizontal) x 900 pixels (vertical) |
| Television System     | PAL - I  |
| Brightness            | 450 cd/m <sup>2</sup>                            |
| Contrast Ratio        | 800:1  |
| Inputs/Output         |  |
| SCART                 | 1  |
| VGA                   | 1  |
| PC Audio In           | 1  |
| Video In              | 1  |
| S-video In            | 1  |
| Phones                | 1  |
| Y Pb Pr               | 1  |
| HDMI IN               | 1  |
| Coxial Out            | 1  |
| TV                    | 1  |
| DVD INPUT             | 1  |
| USB                   | 1  |
| CARD READER           | 1  |
| Speaker Power         | 3 W+3 W  |
| Power Source          | 12 DC via supplied AC adaptor                    |
| Dimension( W x D x H) | 572.9 x 169.8 x 382mm                            |
| Weight(Net)           | 5.3 Kg   |