

Goodmans

INSTRUCTION MANUAL

TFT LCD TV & DVD PLAYER

MODEL: GTVL15N5DVD

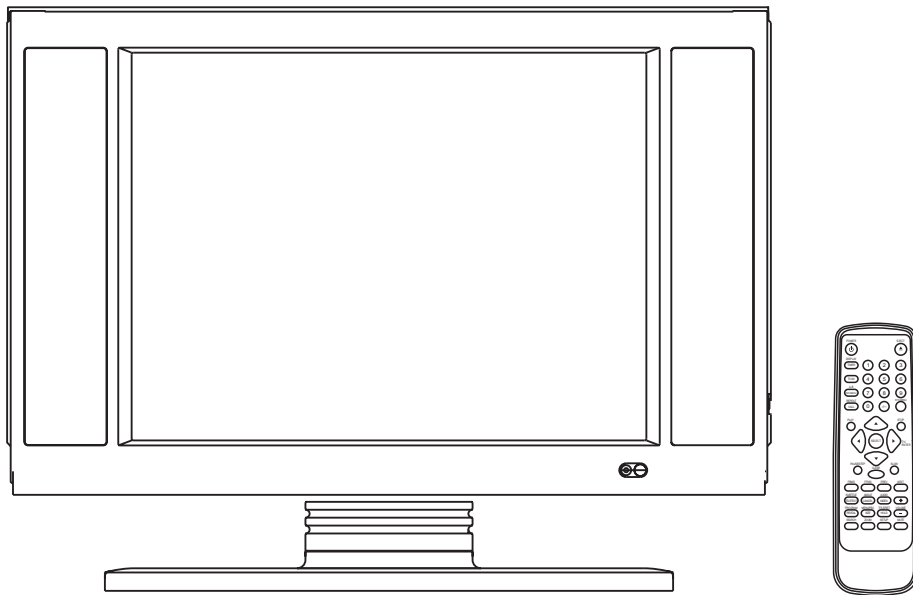

Read these instructions thoroughly before attempting to connect, operate or adjust this player.
Retain the book for future reference.

Goodmans Helpline 0870 8730080

MAINS PLUG WIRING FITTED TO YOUR AC ADAPTOR

PREFITTED MAINS PLUGS

For your convenience a mains plug has been fitted to this appliance. For your safety please observe the following information.

1. Should the fuse in the plug fall remove the plug from the wall socket and replace the fuse with a 3 Amp ASTA approved to BS 1362 fuse.
2. Never use the plug without the fuse cover fitted. Replacement fuse covers are available from your dealer or most electrical retail outlets.
3. If the mains plug is cut off the cable, rewire the replacement plug in accordance with instructions given in this manual.
4. **CAUTION:** Under no circumstances should the discarded plug be inserted into the mains socket. To prevent a shock hazard carefully dispose of the discarded plug. Do not leave the plug lying around where children might see it.

WARNING: To prevent fire or shock hazard do not expose this unit to rain or moisture.

CAUTION: DANGEROUS VOLTAGES EXIST INSIDE THIS UNIT. DO NOT REMOVE COVER (OR BACK). NO USER SERVICEABLE PARTS INSIDE REFER SERVICING TO QUALIFIED SERVICE PERSONNEL. DISCONNECT FROM MAINS SUPPLY WHEN NOT IN USE.

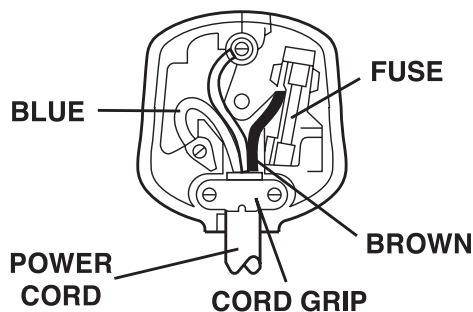

This wires in this mains lead are coloured in accordance with the following wiring codes:
Blue.....Neutral
Brown.....Live

This wires in this mains lead must be connected to the terminals in the plug as follows:

Blue WireN or Black
Brown Wire.....L or Red
Only a 3 Amp fuse should be fitted in the Plug or a 5 Amp fuse at the distribution board.

WARNING: UNDER NO CIRCUMSTANCES MUST THE LIVE OR NEUTRAL WIRES BE CONNECTED TO THE EARTH TERMINAL IN A 3-PIN MAINS PLUG.



This symbol means that this unit is double insulated. An earth connection is not required.

WARNINGS

- Use the adapter supplied only to supply power for your unit.
- Unqualified attempts to repair this TV are not allowed. Refer repairs to this unit to a qualified technician only.
- Do not disassemble this unit. There are dangerous-voltage parts inside that may cause electric shock even after power is disconnected.
- Store your unit only in a clean, dry environment. Unplug the unit immediately it gets wet, and consult your servicing technician.
- Always unplug the unit before cleaning it. Wipe dust off the cabinet of the unit with clean&dry&soft cloth. Apply non-ammonia cleansing lotion onto the cloth, not directly onto the screen.
- Keep your unit away from magnetic objects, motors, TV sets, and transformers.
- Do not place heavy objects on top of the unit.
- Avoid exposing your unit directly to sunlight or other heat sources.
- Put your unit in a well-ventilated area away from high humidity.
- The apparatus and AC/DC adaptor shall not be exposed to dripping or splashing and that no objects filled with liquids, such as vases, shall be placed on apparatus.

Safety Tips

- If smoke, abnormal noise or odour comes out of your unit, power it off immediately and call your local service centre.
- Never try to repair the your unit on your own. Always call your local service center for repairs.
- Watching TV while driving is illegal and dangerous!

Note

This user's manual contains for-reference-only graphics and information that are subject to change without notice.

TABLE OF CONTENTS

MAINS PLUG WIRING		BEFORE ENJOYING DVD/VIDEO CD/CD.....	17
FITTED TO YOUR AC ADAPTOR.....	1	PREPARATIONS.....	17
WARNINGS.....	2	BASIC PLAY.....	17
TABLE OF CONTENTS.....	3	STOPPING PLAY.....	17
CONTROL REFERENCE GUIDE - MAIN UNIT.....	4	SKIPPING AHEAD OR BACK.....	17
CONTROL REFERENCE GUIDE -		PAUSE OR STEP PLAY.....	18
REMOTE CONTROL.....	5	SLOW-MOTION PLAY (DVD/VCD)	18
REMOTE CONTROL PREPARATION.....	6	MP3 PLAYBACK.....	18
BASIC CONNECTION.....	7	BASIC PLAY	
TV OPERATIONS.....	8-11	PLAY MODE	
GET STARTED		KODAK PICTURE CD / JPEG CD.....	18-19
SEARCH A PROGRAM		PLAY MODE	
ADJUST THE VOLUME		SKIP TO NEXT/PREVIOUS PICTURE	
AUDIO EFFECT OPTIONS		ROTATING PICTURES	
TV SETTING MENU		FLIPPING PICTURES	
TV IMAGE SETTING		PICTURE SHRINK/ZOOM	
TV SOUND SETTING		PICTURE CD.....	19
TV CONFIG SETTING		SLIDE SHOW EFFECTS	
TV CHANNEL SETTING		ENJOYING VIDEO CDS WITH PLAYBACK	
VGA SETTING UP.....	11-13	CONTROL.....	19
GET STARTED		ON SCREEN DISPLAY INFORMATION.....	20
VGA SET UP		PROGRAM PLAY.....	20
VGA IMAGE SETTING		REPEAT PLAY.....	20
VGA SOUND SETTING		CHANGING SUBTITLE LANGUAGE (DVD ONLY).....	21
VGA CONFIG SETTING		ZOOM PLAY.....	21
VIDEO OPERATION.....	13	CHANGING AUDIO SOUNDTRACK LANGUAGE	
S-VIDEO OPERATION.....	13	(DVD/VCD DISC).....	21
SCART/DVD/CVBS/S-VIDEO MENU SETTING.....	13-15	VIEWING FROM ANOTHER ANGLE (DVD ONLY).....	21
SCART/DVD/CVBS/S-VIDEO IMAGE SETTING		SEARCH FOR PREFERRED SCENE.....	21
SCART/DVD/CVBS/S-VIDEO SOUND SETTING		MONITOR MAINTENANCE.....	22
SCART/DVD/CVBS/S-VIDEO CONFIG SETTING		CLEANSING	
DVD INITIAL SETTINGS.....	15-17	OTHERS	
COMMON PROCEDURE FOR INITIAL SETTINGS		TROUBLE SHOOTING.....	23
GENERAL SETUP			
AUDIO SETUP			
VIDEO SETUP			
PREFERENCE SETUP			
PASSWORD SETUP			

CONTROL REFERENCE GUIDE - MAIN UNIT

FRONT VIEW

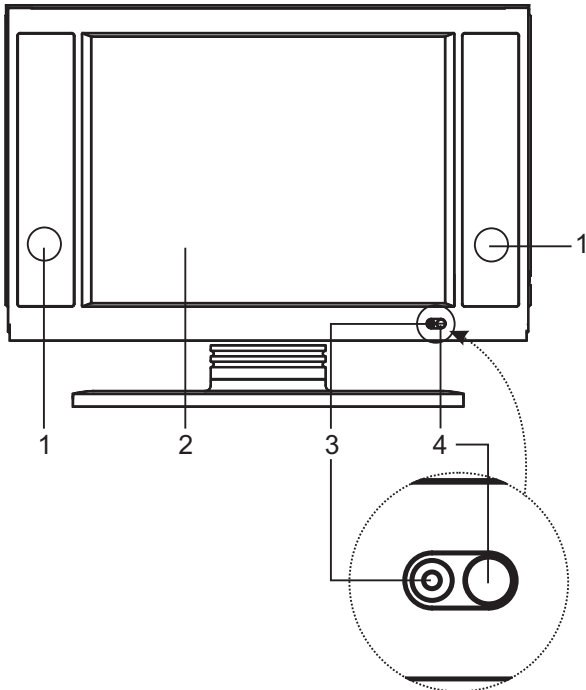

1. SPEAKERS
2. TFT SCREEN
3. POWER ON/OFF INDICATOR
4. REMOTE SENSOR

TOP VIEW

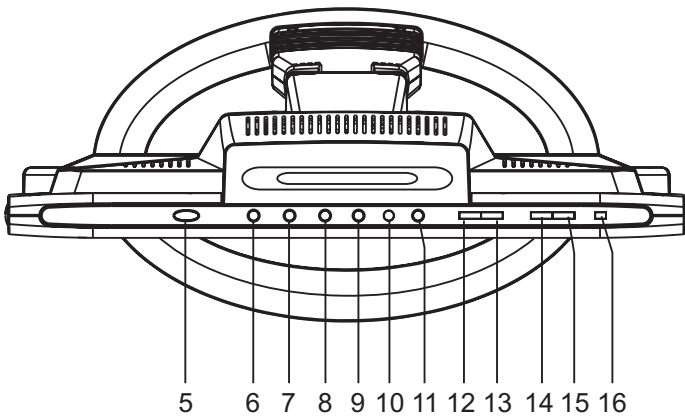

5. POWER ON/OFF BUTTON
6. CHANNEL DOWN BUTTON
7. CHANNEL UP BUTTON
8. VOLUME DOWN BUTTON
9. VOLUME UP BUTTON
10. TV/AV BUTTON
11. MENU BUTTON
12. BACKWARD SKIP/SEARCH BUTTON
13. FORWARD SKIP/SEARCH BUTTON
14. STOP BUTTON
15. PLAY/PAUSE BUTTON
16. EJECT BUTTON

BACK VIEW

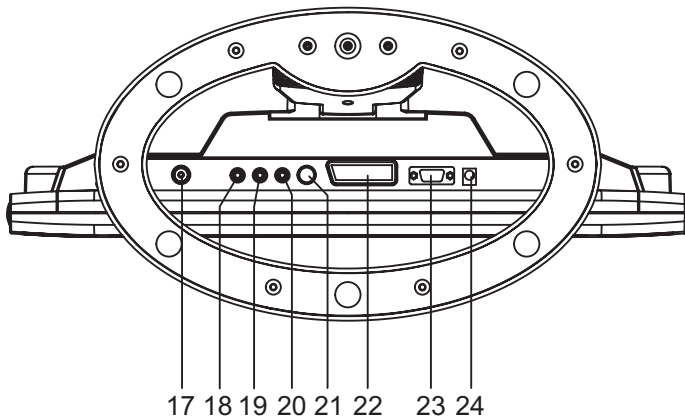

17. IN SOCKET
18. AV IN (RIGHT) SOCKET
19. AV IN (LEFT) SOCKET
20. AV VIDEO IN SOCKET
21. S-VIDEO SOCKET
22. SCART IN SOCKET
23. VGA IN SOCKET
24. DC 12V IN SOCKET

CONTROL REFERENCE GUIDE - REMOTE CONTROL

1. **POWER button** - Press this button to set the player to standby on or off state (if the main power of the set is on).
2. **TIMER button** - Select the sleep time.
DISPLAY button - Press Display button continuously during the playback, the screen will display the elapsed time and remaining time (DVD function key).
3. **TV/AV button** - Select the desired signal input mode.
4. **NICAM/A2 button** - Select Nicam function.
REPEAT A-B button - Press this button, the player will repeat sections between two specific points (A-B)(DVD function key).
5. **REPEAT 1/ALL button** - Press this button, the player will repeat play one chapter or one title (for DVD), or repeat play the current track or the whole tracks (for VCD/CD) (DVD function key).
6. **PLAY button** - Press this button, the player will start to play the disc (DVD function key).
7. **LEFT/RIGHT navigation buttons**
8. **PAUSE/STEP button** - Press this button will halt or show the movie one picture each time (DVD function key).
9. **F.BWD (RED) button**
10. **F.FWD (GREEN) button**
11. **SUBTITLE button** -This button will display the different language on the screen (DVD function key).
TELETEXT button - Press to access TELETEXT function.
12. **ANGLE button** - Press this button will display the angle number and change to different angles (DVD function key).
CANCEL button - Press to exit TELETEXT function.
13. **PROGRAM button** - Press this button can setup the memory order of chapter or title (for DVD) or tracks (for CD) (DVD function key).
REVEAL button - Press this button once, the screen will display the hidden text; press this button twice, the screen will hide the hidden text.
14. **MENU/PBC button** - Select Playback Control for VCD if PBC is on, when you press return button, the player will stat at the VCD root (DVD function key).
SIZE button - Adjust the size of text under TELETEXT interface (Press the button once, the enlarged screen will display the top half text of the TELETEXT interface; press the button twice, the enlarged screen will display the bottom half text of the TELETEXT interface; press the button three times, the screen will display the normal size of text under TELETEXT interface).
15. **SEARCH button** - Press this button during play then press NUMERIC button to choose number corresponding to the desired point (DVD function key).
16. **ZOOM button** - Press ZOOM button to enlarge picture size (DVD function key).
17. **EJECT button** - The tray in and tray out switch button (DVD function key).
18. **NUMERIC buttons** - Use these buttons to select the track.
19. **SYS MENU button** - Press to enter operation interface.
20. **STOP button** - Press this button, the player will stop playing.
21. **SELECT button** - Press this button to confirm what you select.
22. **SLOW button** - Press this button during playback the play speed will be reduced (DVD function key).
23. **NEXT button** - Press this button, the scene will skip to the next chapter or the next track (DVD function key).
24. **PREV (YELLOW)button** - Press this button, the scene will skip to the PREVIOUS chapter or the track (DVD function key).
25. **VOLUME + button** - Press this button, the volume will increase.
26. **AUDIO button** - Select the sound track (DVD function key)
INDEX button - Display the index of TELETEXT.
27. **VOLUME - button** - Press this button, the volume will reduce.
28. **TITLE/RET. button** - Play the title (DVD) or return menu (VCD) (DVD function key).
HOLD button - To hold the TELETEXT playback.
29. **MUTE button** - shut off by pressing this button.
30. **SETUP button** - Press this button will enter initial settings menu (DVD function key).
31. **-/-- button**
32. **CLEAR button** - Clear the input information (DVD function key).
33. **UP/DOWN navigation buttons** - Select the options under OSD setting interface.

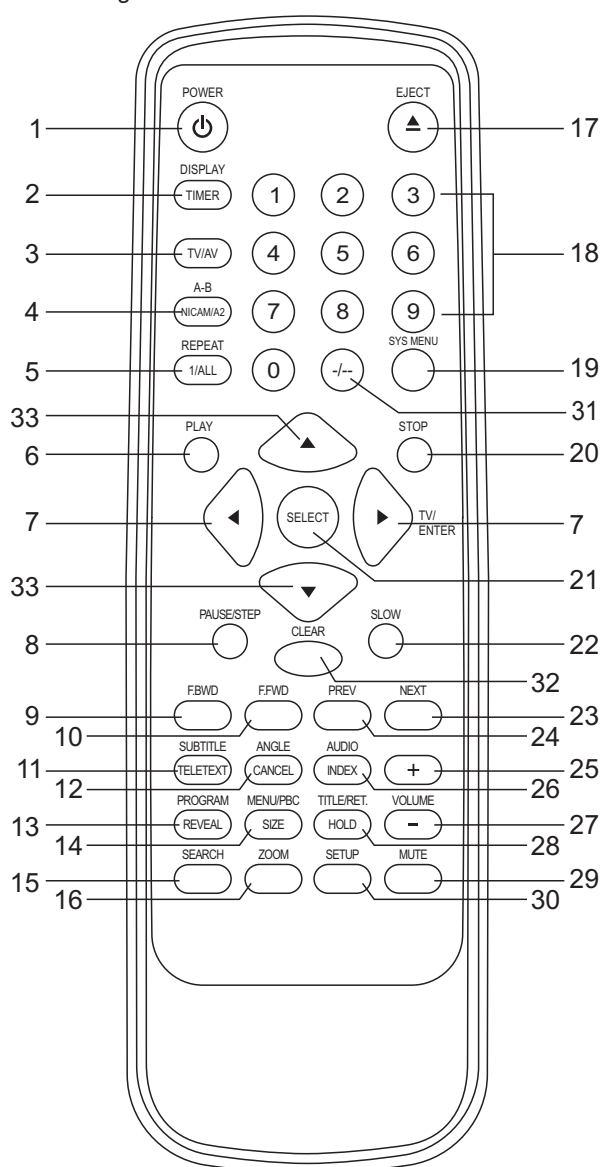

REMOTE CONTROL PREPARATION

Battery Installation A

Insert two batteries observing the correct (+) and (-) polarities engraved beside the battery compartment.

Service life of batteries

- The batteries normally last for about one year. And battery life time may vary with the frequency the remote control unit is used.
- Batteries need replacing if the remote control unit fails to work even near the player's remote sensor. Do not mix new battery with used one or batteries of two different types.
- Use 2 batteries of size AAA.

Notes:

- Do not attempt to recharge, short-circuit, disassemble, heat or throw the batteries into the fire.
- Do not drop, step on the remote control unit. This may irreparable damage.
- If the remote control unit is not going to be used for a long time, remove the batteries. Otherwise, electrolyte may leak which may lead not only to malfunction but to burns if contact is made with the electrolyte.
- Wipe away any electrolyte leaking inside the remote control, and install new batteries.
- If any electrolyte should come into contact with parts of your body, wash it off thoroughly with water.

Remote Control Operation Range B

Point the remote control unit from no further than 7m from and within the scope of 60° in relation to the remote sensor of the player.

- The distance may vary according to the brightness of the room.

Notes:

- Do not point bright lights at the remote control sensor.
- Do not place objects between the remote control unit and the remote control sensor.
- Do not use this remote control unit while simultaneously operating the remote control unit of any other equipment.

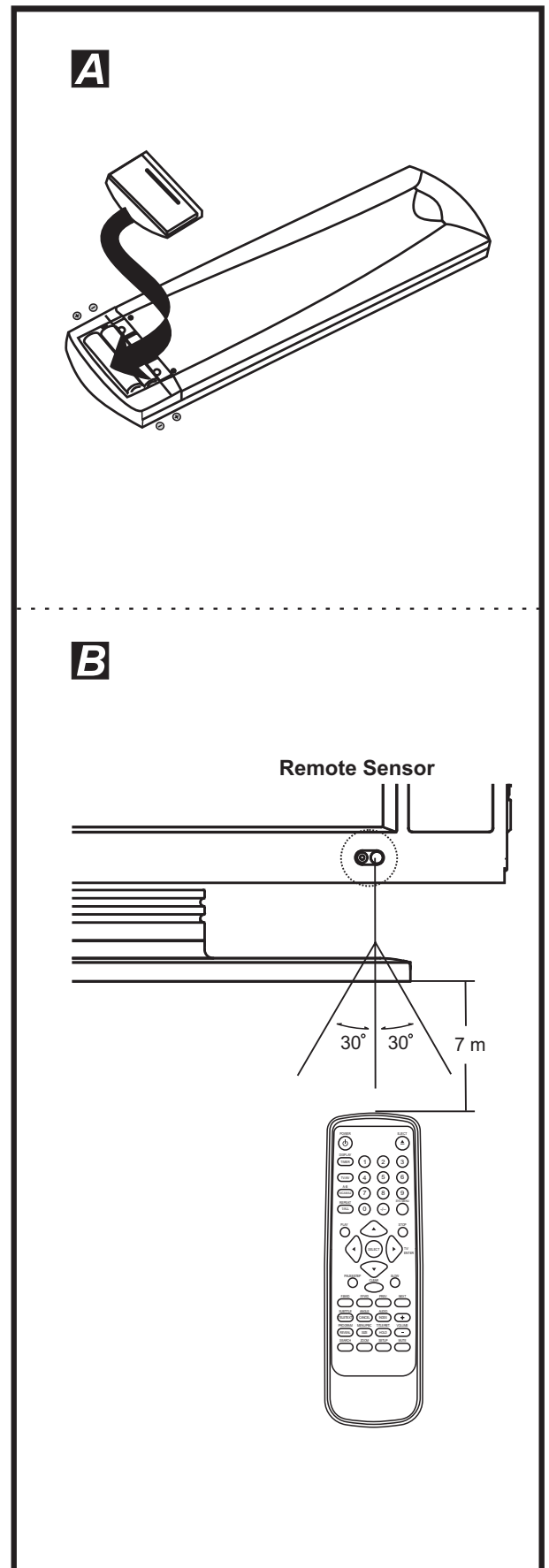

BASIC CONNECTION

Connecting to the AC outlet

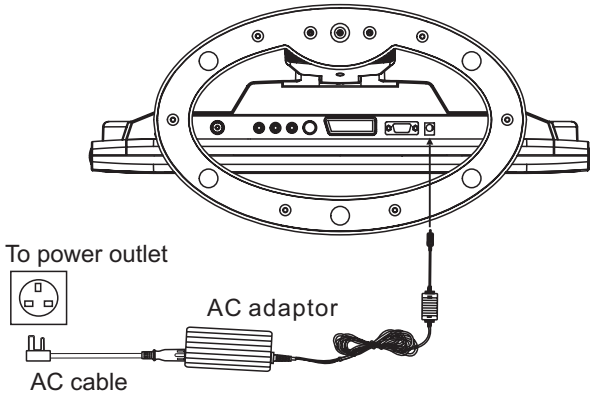

Connecting to DVD/VCD S-Video Terminals

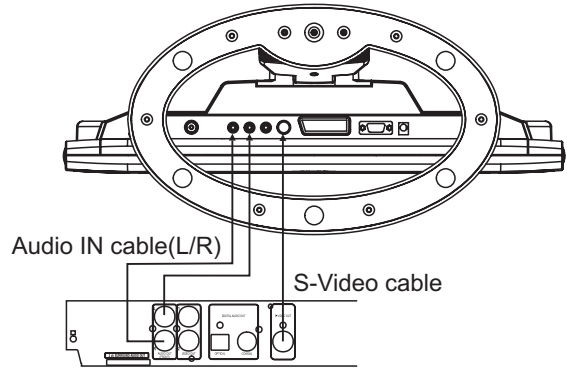

Connecting to the TV

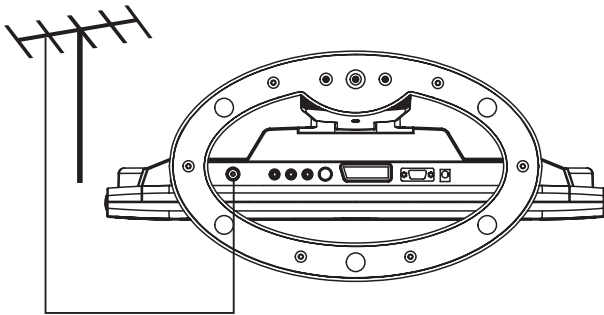

Connecting to PC

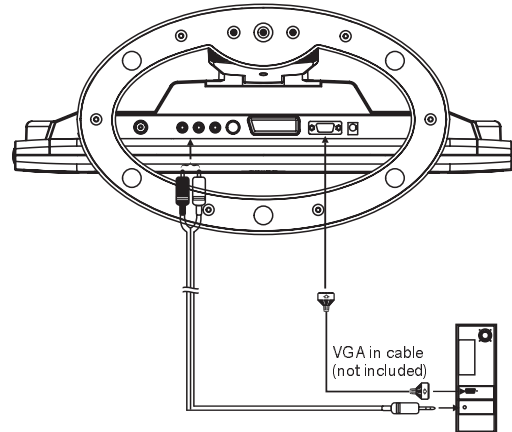

Connecting to DVD/VCD AV Terminals

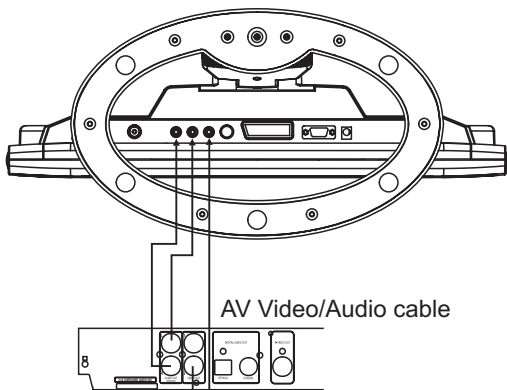

Connecting to DVD with SCART video output connectors

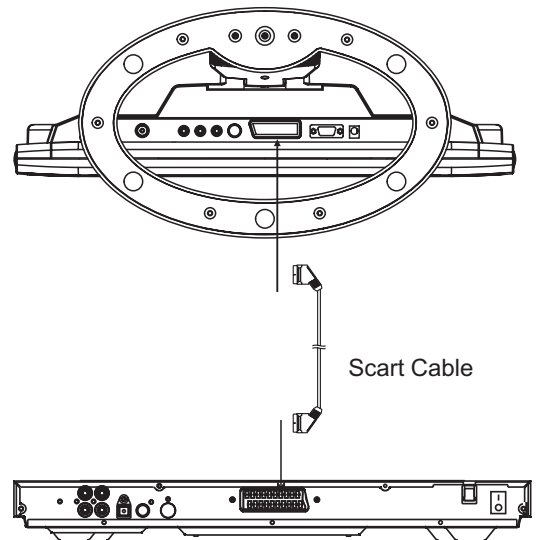

Goodmans Helpline 0870 8730080

TV OPERATIONS

GET STARTED

- Be sure your TV set is connected to the TV properly;
- When the AC adaptor is connected, the power indicator turns red and the TV set turns to standby mode automatically.
- Press POWER button on top of the TV set or on the remote control once to turn on the TV.
- Press the TV/AV button on top of the TV set or on the remote control to switch to TV Mode(TV icon appears at the right top corner of the screen).
- Adjust the monitor according to the angle you would like to watch TV by the TV set.

SEARCH A PROGRAM

- Press CH UP/DOWN button on top of the TV set once, the channel number changes. A desired channel can be reached using these two keys.
- -/-- button on the remote can facilitate you to locate a specific channel. Press this button once, the icon of "-" appears on the screen, input the channel number of 0-9 using numeric buttons; press this button twice, the icon of "--" appears on the screen, input the channel number that exceeds CH 9 using numeric buttons. Do as follows:
To select CH 34
 - Press -/-- button until an icon of -- appears on the screen,
 - Press 3 and then 4.
The channel 34 is selected.

Once the input is done, it will start broadcasting the selected channel immediately.

ADJUST THE VOLUME

TO adjust the volume, use the VOLUME UP/DOWN buttons on the top unit or on the remote control.

TV SETTING MENU

Press once the MENU button on top of the unit or on the remote control, the screen will pop up a setting menu; Use the MENU button on the remote control to confirm the item to be set; use the Arrow up/down buttons on top of the TV set or on the remote control to select among the setting options and then press MENU button again to confirm. Use arrow left/right buttons to adjust the value. Press again MENU button to confirm and return the previous menu.

Use the Arrow up/down buttons to scroll to the next setting item

Use the MENU button to return to the previous menu. Press the MENU button continuously to exit the setting menu. Or scroll to the Item EXIT. Or leave the unit idle for some seconds, the unit will exit Setting MENU automatically.

1.TV IMAGE SETTING

1) Set the mode

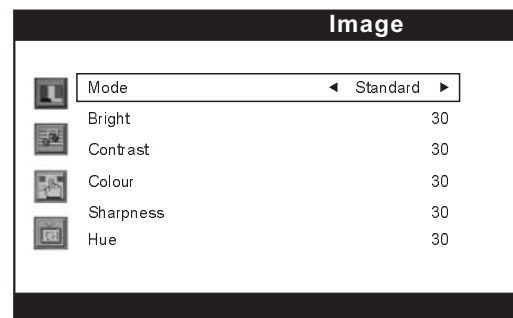

Adjust the mode by using the Arrow left/right buttons to scroll among the options: Standard, Dynamic, Mild, Custom.

2) Set the brightness

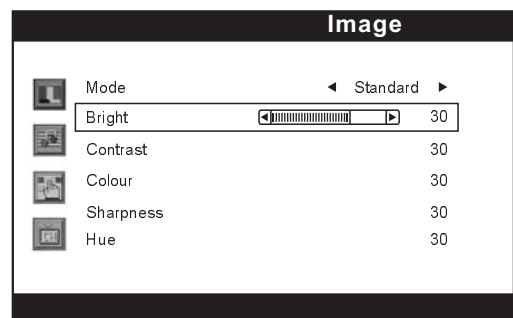

Adjust the by using the Arrow left/right buttons until the desired effect is reached.

3) Set the Contrast

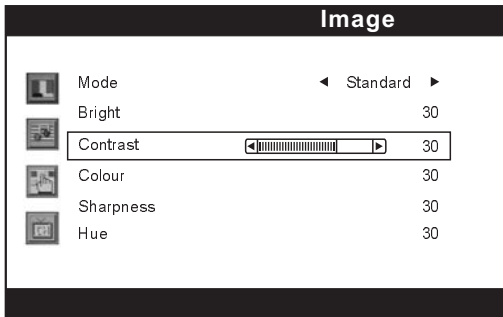

Adjust the Contrast by using the Arrow left/right buttons until the desired effect is reached.

4) Set the Colour

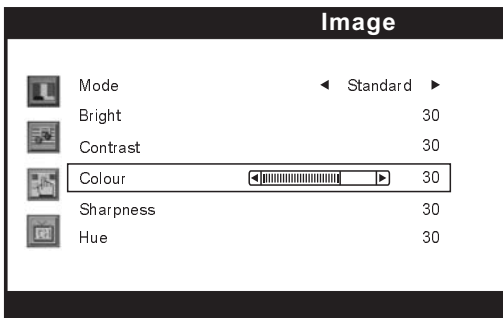

Adjust the Colour by using the Arrow buttons until the desired effect is reached.

5) Set the Sharpness

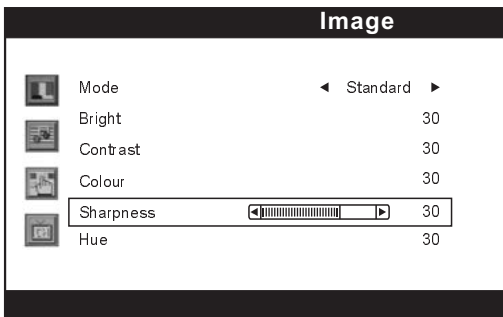

Adjust the Sharpness by using the Arrow left/right buttons until the desired effect is reached.

6) Set the Hue

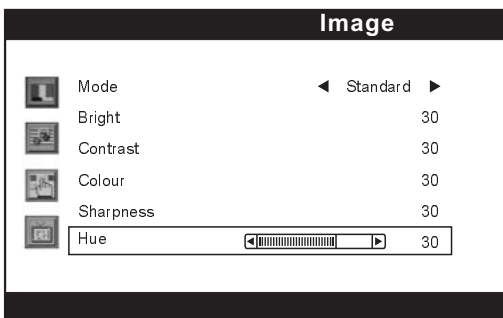

Adjust the Hue by using the Arrow buttons until the desired effect is reached
Note: Hue adjustment is only available when receiving NTSC TV.

2. TV SOUND SETTING

1) Set the mode

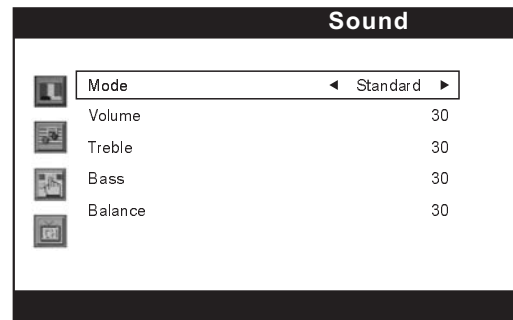

Adjust the mode by using the arrow left/right buttons to scroll among the options: Standard, Movie, Custom, Speech.

2) Set the Volume

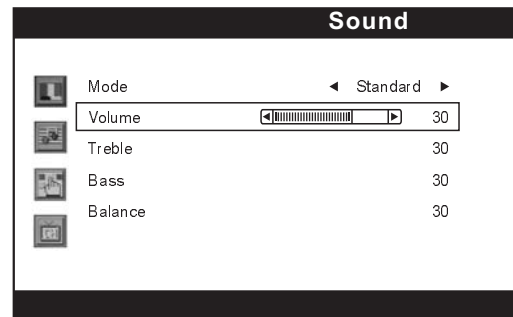

Adjust the Volume until the desired effect is reached.

3) Set the Treble

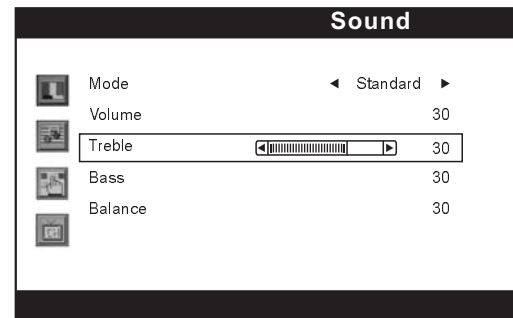

Adjust the Treble until the desired effect is reached.

4) Set the Bass

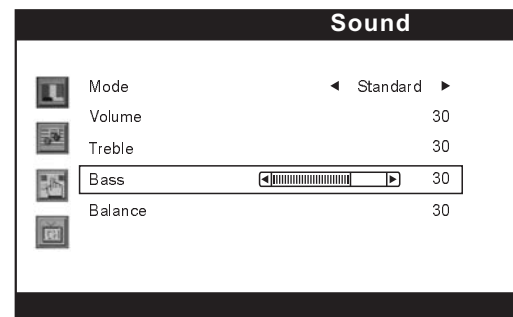

Adjust the Bass until the desired effect is reached.

5) Set the Balance

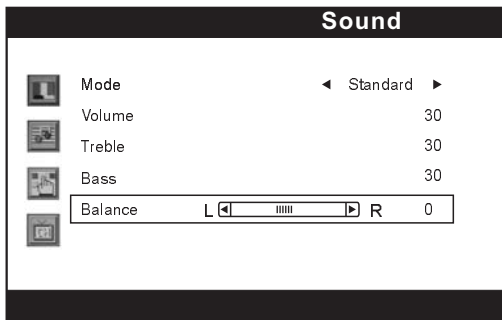

Adjust the Balance between the left speaker and right speaker by using Arrow buttons until the desired effect is reached.

4) Set the Reset

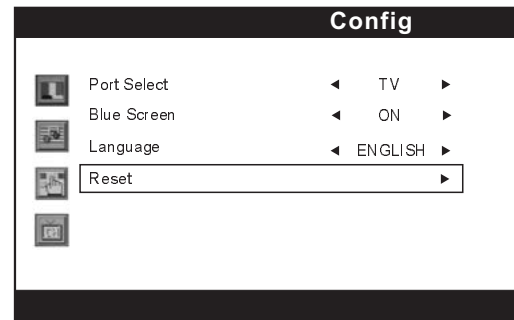

Scroll to Reset , When Reset is done, the settings are cleared and return to default settings.

3. TV CONFIG SETTING

1) Set the Port Select

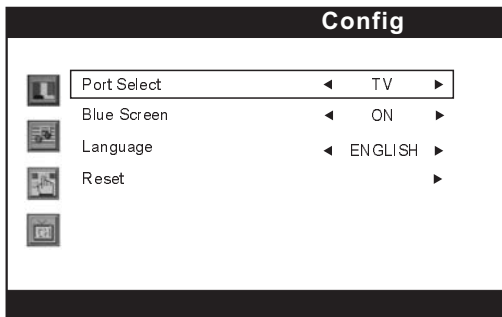

Select the Port Select by using the Arrow left/right buttons to scroll among the options: TV, SCART, DVD, CVBS, SVIDEO, PC.

2) Set the Blue Screen

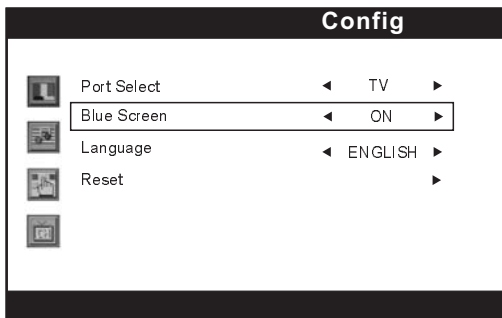

Use the Arrow left/right buttons to select the two options to set the color of the screen: ON/OFF.

3) Set the Language

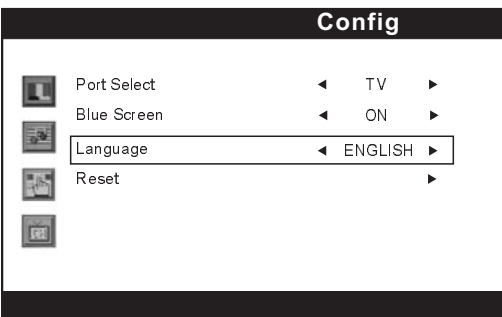

Use the Arrow buttons to select the desired language.

4. TV CHANNEL SETTING

1) Auto Tune

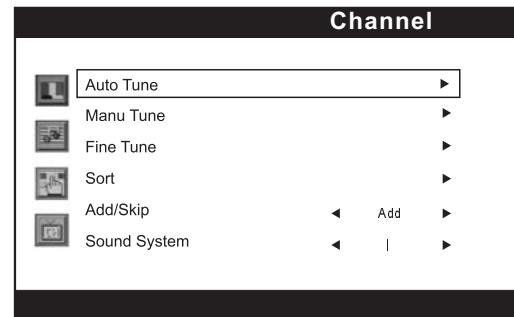

Scroll to Auto Tune and press Arrow right button to begin searching for and store channels automatically that are found; press MENU button to exit the Auto Tune mode.

2) Manual Tune

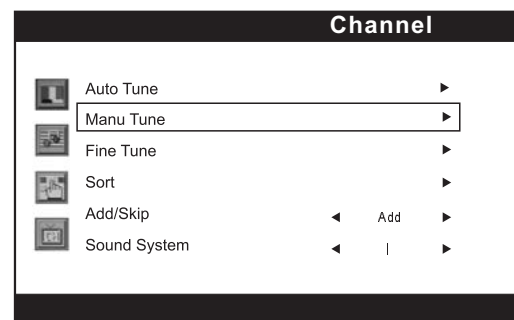

Scroll to Manual Search and press Arrow buttons to scroll the Channel 1. You have to select which program channel you will store the memory before start tuning channel by pressing CH UP or DOWN. After complete channel tuning, press TV/AV button to exit setup menu, and press the MENU button to save the channels.

3) Fine tune

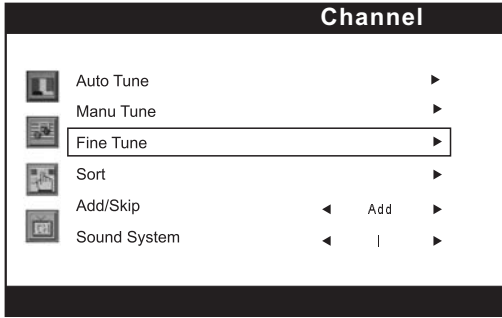

Scroll to Tuning and Use Volume UP or DOWN button to fine tune the current channel to a desired effect.

4) Sort setting

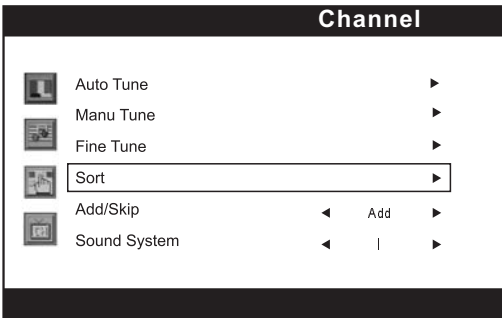

Select the Sort item and press the Arrow right button to confirm, the screen will appear a dialog box, select a channel by inputting digits on the remote control under the source, then select the destination channel by inputting the digits under the destination; then press the MENU button to exchange and TV/AV button to cancel the setting.

5) Add/Skip setting

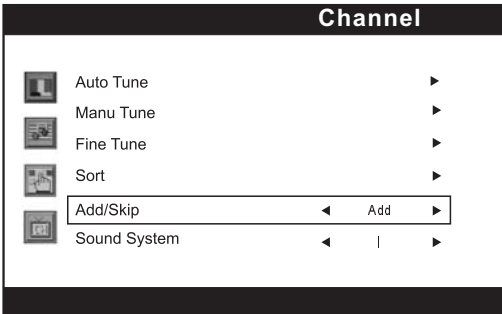

Select the Add/Skip item, then press the Arrow left/right buttons to select between the two options: Add or Skip; when selecting the Skip option, you can skip the channel that you don't like to watch, if you want to resume the skipped channel, you can select the Add option.

6) Sound System Setting

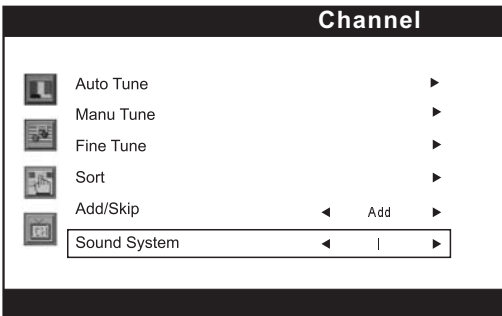

Scroll to Sound System item, and press the Arrow left/right buttons to select among the options: I, D/K, L, B/G
Note: UK sound is PAL I

VGA SETTING UP

GET STARTED

This unit supports VGA input, allowing you to use it as a PC monitor for more clear picture with a resolution of up to 1024X768; it features multi-media sound effects with its built-in audio amplifier.

Make sure this unit is connected to PC correctly:
Power the unit on; press the POWER button on top of the monitor or on the remote control to turn on the TV; use the TV/AV button to switch to PC mode; the icon "PC" is shown at the right top corner of the screen.
Turn on your PC and now you can use this player as a monitor.

NOTE:

1. The default resolution of your PC should not exceed 1024X768.
2. The frame upgrade frequency should not exceed 75Hz, otherwise, this unit will not work in a normal way. -- in case of such failures, the message "signal out of range" appears on the screen.

VGA SET UP

Press once the MENU button on top of the unit or on the remote control, the screen will pop up a setting menu; use the Arrow up/down buttons on the remote control to select among the setting options and then press MENU button again to confirm. Use LEFT/RIGHT navigation buttons to adjust the value. Press again MENU button to confirm and return the previous menu.
Use the Arrow up/down buttons on the remote control to scroll to the next setting item.
Use the MENU button to return to the previous menu. Press the MENU button continuously to exit the setting menu. Or leave the unit idle for some seconds, the unit will exit Setting MENU automatically.

1. VGA IMAGE SETTING

1) Adjust the brightness

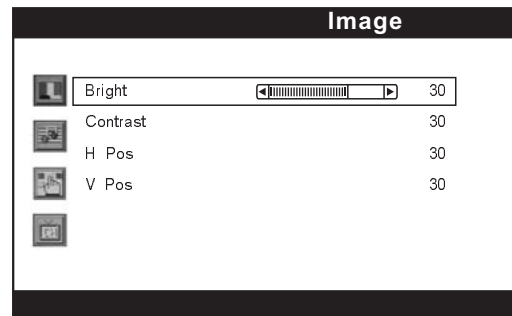

Adjust the brightness until the desired effect is reached.

2) Adjust the contrast

Adjust the until the desired effect is reached.

3) Select the H Pos setting

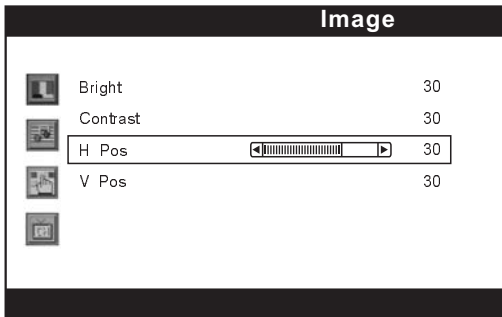

Scroll to H.Position .
Use Arrow left/right buttons to adjust the value.
The screen will move horizontally .

4) Set the V Pos setting

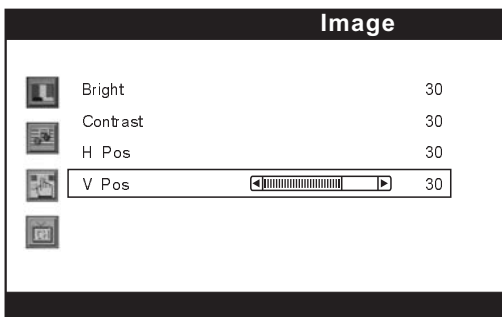

Scroll to V.Position .
Use Arrow left/right buttons to adjust the value.
The screen will move vertically.

2.VGA SOUND SETTING

1) Adjust the volume

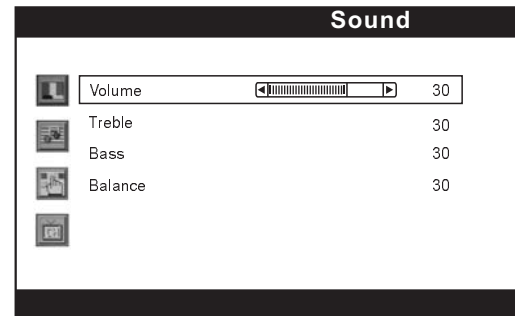

Adjust the Volume until the desired effect is reached.

2) Adjust the treble

Adjust the Treble until the desired effect is reached.

3) Adjust the bass

Adjust the Bass until the desired effect is reached.

4) Adjust the Balance

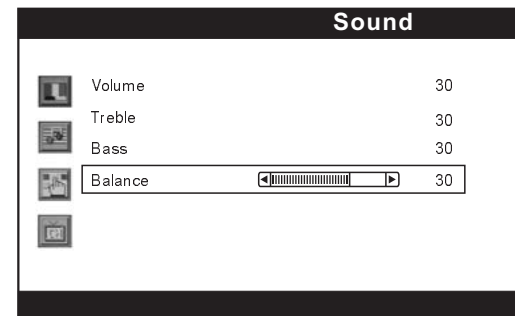

Adjust the Balance until the desired effect is reached.

3. VGA CONFIG SETTING

1) Port select setting

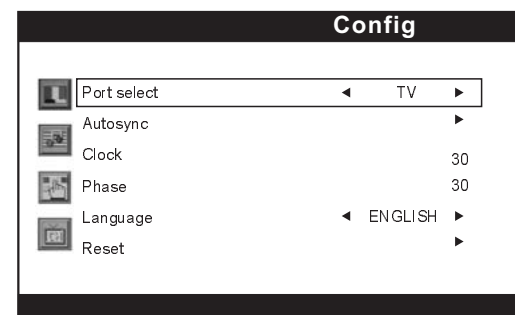

Select the Port Select by using the Arrow left/right buttons to scroll among the options: TV, SCART, DVD, CVBS, SVIDEO, PC.

2) Autosync setting

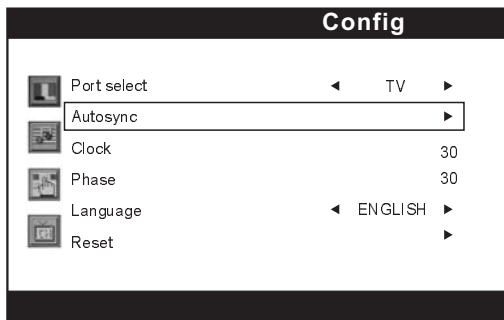

Scroll to Auto Adjust .
The Screen will do a self-adjustment immediately.
It will vibrates for some seconds and returns to normal.
After a self-adjustment process, the default optimum status is reached.

3) Select the clock setting

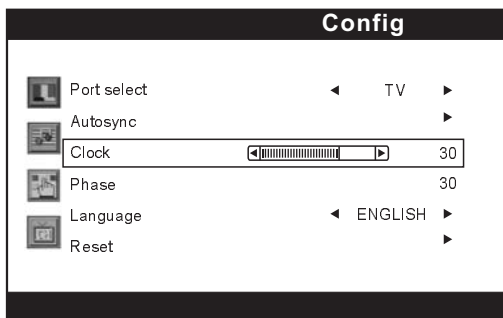

Scroll to Clock .
Use Arrow left/right buttons to adjust the value.
The screen will move either to the right or the left taking either the left edge or the right edge as bench-mark.

4) Select the phase

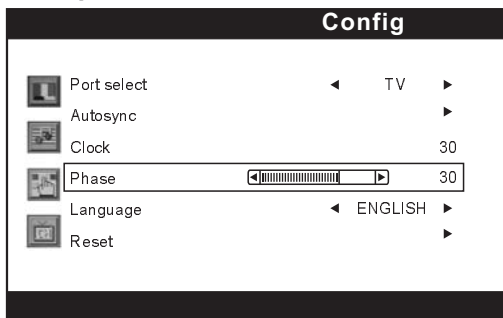

Scroll to Phase .
Use the Arrow left/right buttons to adjust the phase when the characters or pictures appear fuzzy throughout the entire screen.

5) Select the language

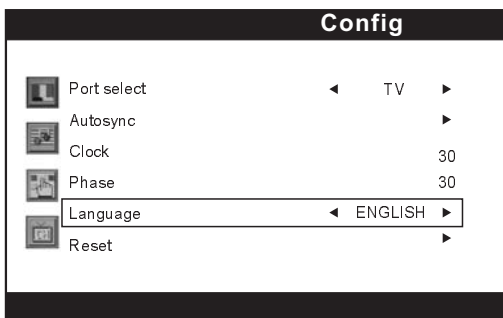

Scroll to Language .
Use Arrow buttons to select among the six languages:
English, German, French, Italian, Spanish and Portuguese.

6) Reset setting

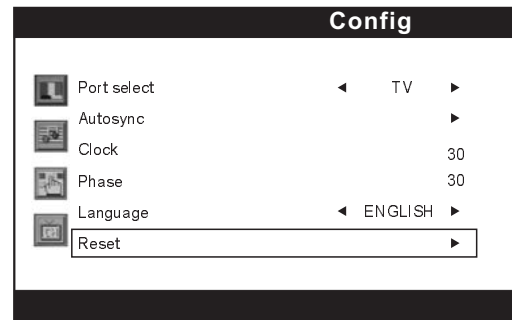

Scroll to Reset , When Reset is done, the settings are cleared and return to default settings.

VIDEO OPERATION

This unit features a group of AV input terminals, allowing you to connect it to external video devices. Make sure the connection is done correctly(refer to the basic connection section.)

Power this unit on and set the working mode to VIDEO by means of the TV/AV button.

Power on the external video device.

S-VIDEO OPERATION

This unit features an S-video input terminal, allowing you to connect it to external video devices. Make sure the connection is done correctly(refer to the basic connection section.)

Power this unit on and set the working mode to S-VIDEO by means of the TV/AV button.

Power on the external video device.

NOTES:

This unit provides auto-protection against situations of no signal for the three external signal input modes(VIDEO/S-VIDEO/VGA): the screen turns blue in both cases of signal loss and abnormal signal. In this case, "No Signal" shows on he screen; when signal source returns to normal, the screen turns to natural display.

SCART/DVD/CVBS/S-VIDEO MENU SETTING

Press the MENU button on the top unit or on the remote control once, the screen will pop up the setting menu; use the Arrow up/down buttons on the remote control to select among the setting options and then press MENU button again to confirm. Use the LEFT/RIGHT navigation buttons to adjust the value.

Use the UP/DOWN navigation buttons to scroll to the next setting item

Use the MENU button to return to the previous menu. Press the MENU button continuously to exit the setting menu. Or leave the TV set idle for some seconds, the TV will exit Setting MENU automatically.

1. SCART/DVD/CVBS/S-VIDEO IMAGE SETTING

1) Set the mode



Adjust the mode by using the Volume up/down buttons to scroll among the options: Standard, Dynamic, Mild, Custom.

2) Set the brightness

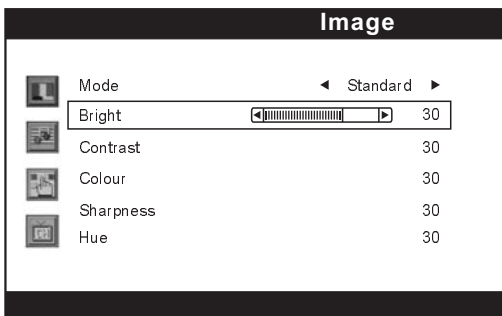

Adjust the brightness until the desired effect is reached.

3) Set the Contrast

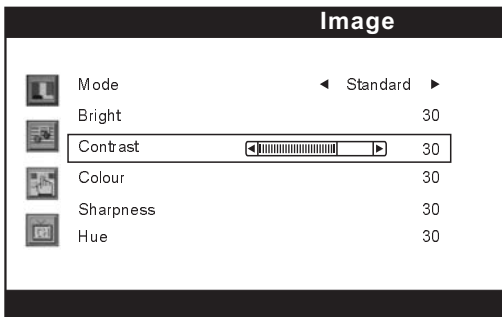

Adjust the Contrast until the desired effect is reached.

4) Set the Colour

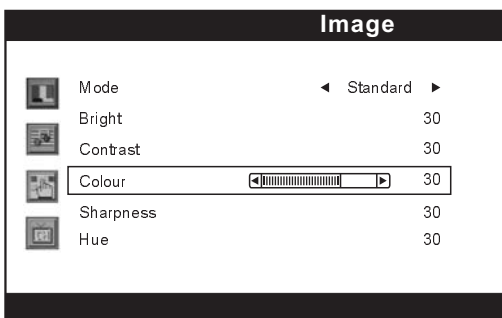

Adjust the Colour until the desired effect is reached.

5) Set the Sharpness

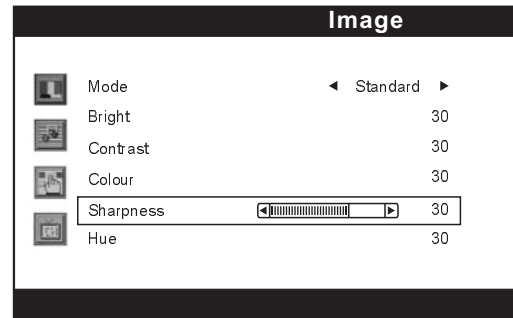

Adjust the Sharpness until the desired effect is reached.

6) Set the Hue

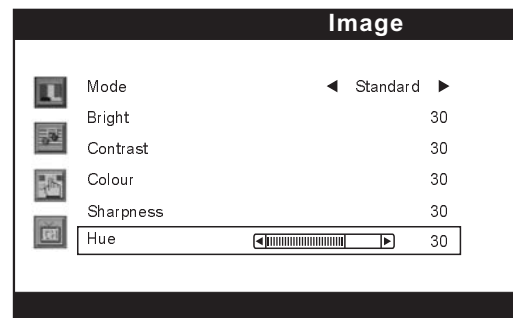

Adjust the Hue until the desired effect is reached(Not for DVD).

2. SCART/DVD/CVBS/S-VIDEO SOUND SETTING

1) Set the mode

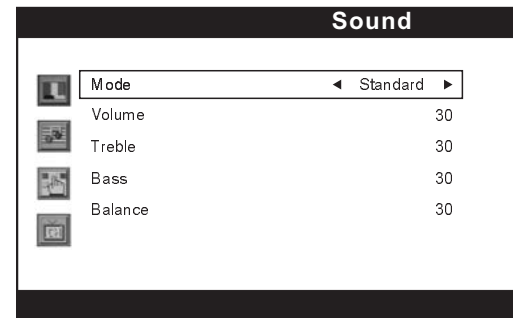

Adjust the mode by using the Volume up/down buttons to scroll among the options: Standard, Movie, Custom, Speech.

2) Set the Volume

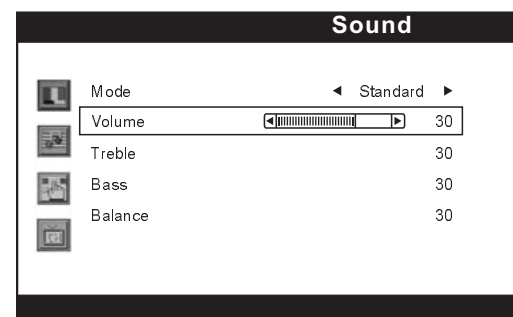

Adjust the Volume until the desired effect is reached.

3. SCART/DVD/CVBS/S-VIDEO CONFIG SETTING

1) Set the Port Select

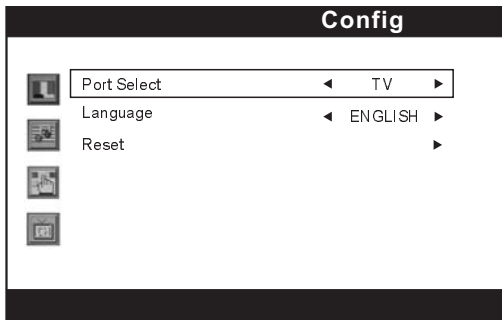

Select the Port Select by using the Arrow left/right buttons to scroll among the options: TV, SCART,DVD, CVBS, SVIDEO, PC.

2) Set the Language Setting

Scroll to Language
Use Arrow buttons to select among the six languages:
English, German, French, Italian, Spanish and Portuguese.

3) Set the Reset

Scroll to Reset , When Reset is done, the settings are cleared and return to default settings.

DVD INITIAL SETTINGS

- Once the initial programming is entered it is retained in memory until changed, the player can always be operated under the same conditions.
- The settings will be retained in the memory until the settings are changed even after setting the player to the standby mode.

Common procedure for initial settings

1. Press SETUP button.
2. Use the navigation buttons to select preferred item, then press SELECT button, each screen for setting the value is displayed.
3. Press SETUP button to close setup menu in any mode.
4. Use left navigation button to switch to another main setup items.

1. General setup

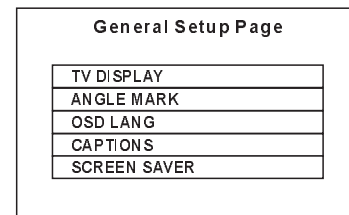

- 1.1 TV DISPLAY** - it is used to select the TV output mode.
Options: NORMAL /PS: Pan & scan mode
NORMAL/ L/B: Letter box mode
WIDE : 16:9 wide screen mode
- 1.2 ANGLE MARK** - it is used to select whether or not the multi- angle icon is display on the screen when a multi-angle DVD disc is playing.
Options: On: Icon will be displayed
Off: Icon will be turned off
- 1.3 OSD. LANG** - it is used to select different On Screen Display language for different user.
Options: English
- 1.4 CAPTIONS** - It is used to select the captions on or off.
Options: On: Captions is enabled
Off: Captions is disabled
- 1.5 SCREEN SAVER** - when the player is not in used for 2 minutes, a running DVD logo will move across the TV screen to protect the TV CRT.
Options: On: Screen saver is enabled
Off: Screen saver is disabled

2. Audio setup

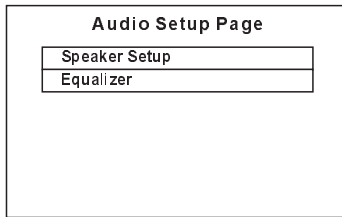

2.1 SPEAKER SETUP - it is used to set the speaker outputs levels.

DOWNMIX mode

Options: LT/RT - Left/Right mix mode

STEREO - Select this option if you don't have a 5.1 channels amplifier.

2.2 Equalizer

Eq type

SOUND MODE: OFF/ROCK/POP/LIVE/DANCE/
TECHNO/CLASSIC/SOFT

BASS BOOST: ON/OFF

SUPER BASS: ON/OFF

TREBLE BOOST: ON/OFF

3. Video setup

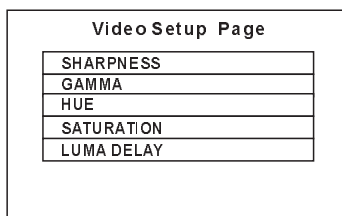

3.1 SHARPNESS - to set the sharpness for the display.
Options: HIGH MEDIUM LOW

3.2 GAMMA - to set the gamma effect for display.
Options: HIGH MEDIUM LOW NONE

3.3 HUE - to set the colour impression for display.

3.4 SATURATION - to set the saturation level for display.

3.5 LUMA DELAY
Options: 0T 1T

4. Preference setup

Power on this set by pressing power button without placing any disc, press setup button, then you can enter the Preference Page by pressing navigate button .

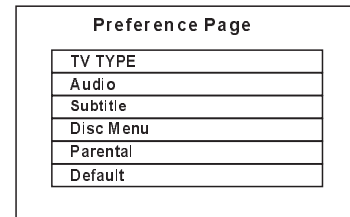

4.1 TV TYPE

Options: PAL

4.2 AUDIO - select preferred audio language.
(DVD only - need disc software support)

4.3 SUBTITLE - select preferred subtitle language.
(DVD only - need disc software support)

4.4 DISC MENU - select preferred disc menu language.
(DVD only - need disc software support)

4.5 PARENTAL - select rating levels. You must set PASSWORD MODE OFF to enable this selection.
(DVD only - need disc software support)

4.6 DEFAULT - Reset to factory settings

5. Password Setup

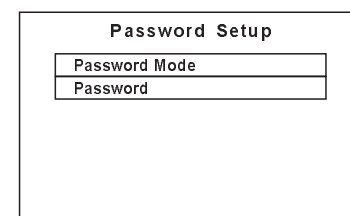

5.1 PASSWORD MODE
Options: ON/OFF

5.2 PASSWORD
Option: Change
Select to change password

5.2.1 OLD PASSWORD

5.2.2 NEW PASSWORD

5.2.3 CONFIRM PWD

Procedure to change password:

- 1) Enter old password in the OLD PASSWORD row.
- 2) Enter new password in the NEW PASSWORD row.
- 3) Enter the new password again in the CONFIRM PWD row.

You may reset the password if you forget the old password by using the supervisor password: 1389

Before enjoying DVD/Video CD/CD

The On-Screen menu language of your player has been factory pre-set to English.

If you would like to change the menu language to other language, please refer to "Selecting language of On-Screen Display menu".

In the explanation given below it is assumed that English has been selected as the menu language.

Preparations

Switch the TV ON and select "Video" as the TV input. Switch on the stereo system's power if the player has been connected to a stereo system.

Basic play

1. Press POWER to switch on the power.
2. Insert a disc into the disc slot, the player will start to read the disc immediately.

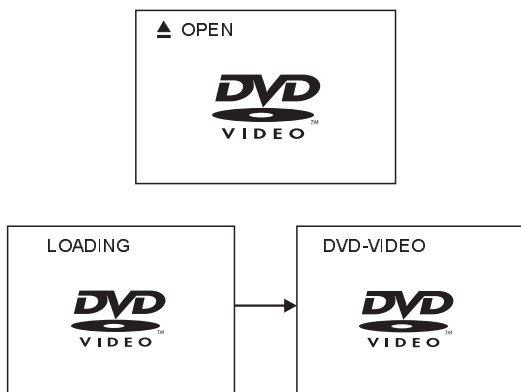

3. When a menu screen appears on the TV, move the navigation buttons or press the numeric buttons to select preferred track number, then press SELECT button to confirm.

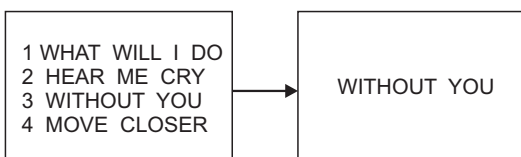

4. When the menu continues onto another screen, press NEXT SKIP button to view the next screen, or press PREV SKIP button to skip to previous screen.
NOTE: Due to the different design of some software titles, NEXT button may not always work.
5. To stop play and return to the menu screen, press TITLE button, or MENU button(which button is pressed differs depending on the disc used)DVD, PRESS TITLE, MENU or RETURN. Video CD, press RETURN.

Stopping play

Press STOP

For your convenience:

When player is stopped, the player records the point where STOP was pressed (RESUME function). Press PLAY again, playback will resume from this point. When the tray is opened or STOP is pressed again, the RESUME function will be cleared.

Skipping ahead or back

Skipping ahead

Press NEXT SKIP ►► button during play. A chapter(DVD) or a track (Video CD/CD) is skipped each time the button is pressed.

Skipping back

Press PREV SKIP ◄◄ button during play. A chapter (DVD) or a track (Video CD/CD) is skipped each time the button is pressed.

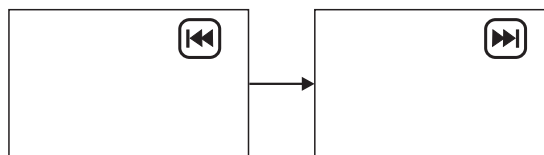



Rapid advance(Rapid reverse)

During playback, press F.FWD button ►► or F. BWD ◄◄ button to fast forward/rewind.

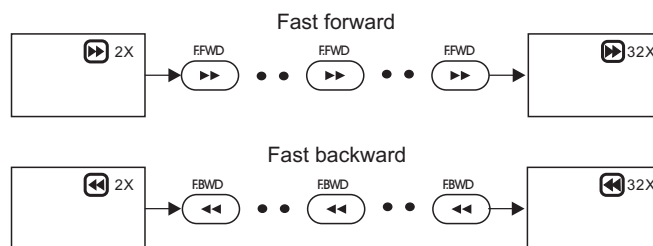
Press PLAY button to resume normal play.



Pause or step play

During playback, press PAUSE/STEP  button, the play will be paused, and in this mode, each time the PAUSE/STEP  button is pressed, the player will only play one picture, to resume normal play, press PLAY  button.

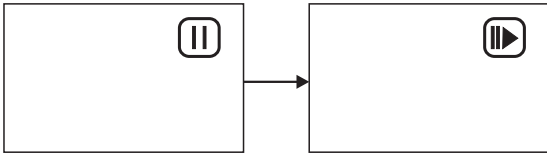

Slow-motion play (DVD/VCD)

On the remote control unit

Press SLOW  button during playback.

- Plays the disc at a 1/2 of normal speed at first. Each time the button is pressed, the play speed becomes slow (1/2, 1/4, 1/8, 1/16)
- Press PLAY button, normal play will resume.



MP3 PLAYBACK

Basic play

1. Insert the disc containing the files in MP3 format to be played and after a few seconds, the TV screen will show all folders on the disc.

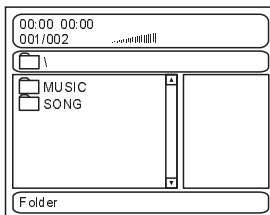

2. Select the folder you want to play by the navigation buttons and press SELECT button to confirm.
3. The files in this folder are displayed and select your favourite song by using the up/down navigation buttons and press SELECT button to start playback.

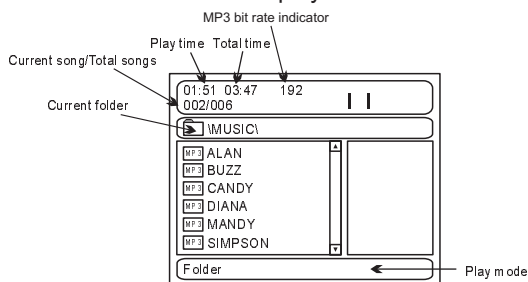

Note: Maximum 11 characters including space can be displayed for the filename. Non-English file name will not be displayed correctly.

4. Press NEXT button to see the next page or PREV button to see the previous page.
5. Press REPEAT 1/all button change play mode.

Play mode:

FOLDER - all the files in the folder will be played.

RANDOM - randomly select any file to play.

SINGLE - play one file only.

REPEAT ONE - repeat one file.

REPEAT FOLDER - all the files in the folder will be played repeatedly.

KODAK PICTURE CD / JPEG CD

- If Kodak Picture CD is inserted, slide show is begins automatically.
- For JPEG picture CD, select the folder you want to play by the navigation buttons and press SELECT button to confirm.
- The files in this folder are displayed and select your favourable pictures by using the up/down navigation buttons and press SELECT button to start playback. Thumbnail of picture will be displayed while you scrolling across the file name.

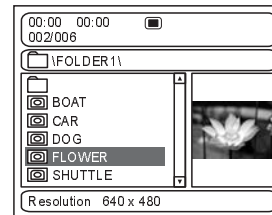

Play mode:

FOLDER - all the files in the folder will be played.

RANDOM - randomly select any file to play.

SINGLE - play one file only.

REPEAT ONE - repeat one file.

REPEAT FOLDER - all the files in the folder will be played repeatedly.

Once a folder and file is selected, the picture is load onto the TV screen.



Note: The time to load and display picture depends on the file size of the pictures.

During playback, press MENU button to return to folder selection or STOP button to enter preview mode.

Skip to next/previous picture

Press NEXT button to skip to the next picture or PREV button to skip to the previous picture.

If no key is pressed for 5 seconds, it will skip to next picture automatically.

Rotating pictures

- Press RIGHT navigation button to rotate the picture clockwise.
- Press LEFT navigation button to rotate the picture counter-clockwise.



Flipping pictures

- Press UP navigation button to flip the picture vertically.
- Press DOWN navigation button to flip the picture horizontally.



Picture Shrink/Zoom

- Press ZOOM button to enter the zoom mode.
- Press F. FWD button to enlarge picture to 100%, 125%, 150% and 200%.
- Press F. BWD button to shrink enlarge pictures to 50%, 75%, and 100%.



If the picture is enlarged, you may press navigation buttons to see other portions of the picture.

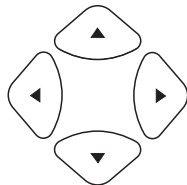

PICTURE CD

Slide show effects

Press PROGRAM button to select one of the effects when changing from one picture to another:

- 1 WIPE TOP
- 2 WIPE BOTTOM
- 3 WIPE LEFT
- 4 WIPE RIGHT
- 5 DIAGONAL WIPE LEFT TOP
- 6 DIAGONAL WIPE RIGHT TOP
- 7 DIAGONAL WIPE LEFT BOTTOM
- 8 DIAGONAL WIPE RIGHT BOTTOM
- 9 EXTEND FROM CENTRE H
- 10 EXTEND FROM CENTRE V
- 11 COMPRESS TO CENTRE H
- 12 COMPRESS TO CENTRE V
- 13 WINDOW H
- 14 WINDOW V
- 15 WIPE FROM EDGE TO CENTRE
- 16 MOVE IN FROM TOP
- 17 NONE

ENJOYING VIDEO CDS WITH PLAYBACK CONTROL

- When playing VCD 2.0/3.0 with PBC, the player will show the VCD on the screen.

VCD

- After a few seconds, a menu will appear on the screen.

1 WHAT WILL I DO
2 HEAR ME CRY
3 WITHOUT YOU
4 MOVE CLOSER

- Press numeric buttons to select corresponding track, if the track number is under 10, choose one of the numeric buttons 0 ~ 9.
- If the track number is exceed 10, press +10 button firstly, then press numeric buttons 0 ~ 9.
- During playback, press RETURN button to return to main menu.
- Press NEXT SKIP ►► button or PREV SKIP ◀◀ button, the player will play in the scheduled sequence on the disc.

ON SCREEN DISPLAY INFORMATION

When the player is under operation, press DISPLAY button continuously on the remote control, the screen will display sequentially parts of information, all information and clear information.

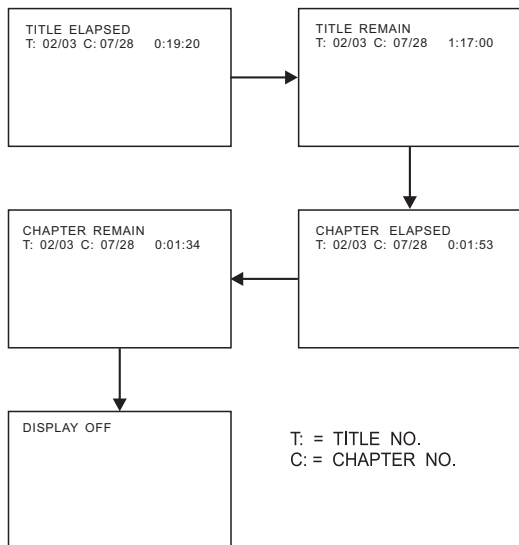

Press "DISPLAY" button again, the screen display will be cleared.

PROGRAM PLAY

The player plays the tracks in the disc in an order you desired.

1. Press PROGRAM button and the screen will display the program menu.

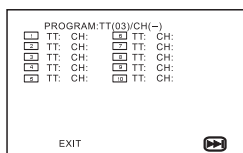

2. Press navigation buttons to choose memory index and then press SELECT button to start input. Enter desired Titles/Chapters numbers by using the numeric buttons. The selected Titles/Chapters are stored into the memory. Select NEXT on the menu to see the next page. Up to 20 memories can be stored.

Note: Leading zero is not necessary. If the track number is more than 10, press the 10 key first and then the unit digit.

Example: Track 3, press "3"

Track 12, press "+10" and then "2"

Track 21, press "+10" twice and then "1"

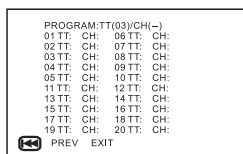

3. To start program play, select START on the menu or select EXIT on the menu to exit without program play.
4. To clear programmed items, scroll the navigation button to the item to be cleared and press CLEAR button on the remote control, the selected item will be deleted.

REPEAT PLAY

Press REPEAT 1/ALL button during play, it will repeat play one chapter or one title (for DVD disc), or repeat play track (for VCD/CD).

DVD DISC

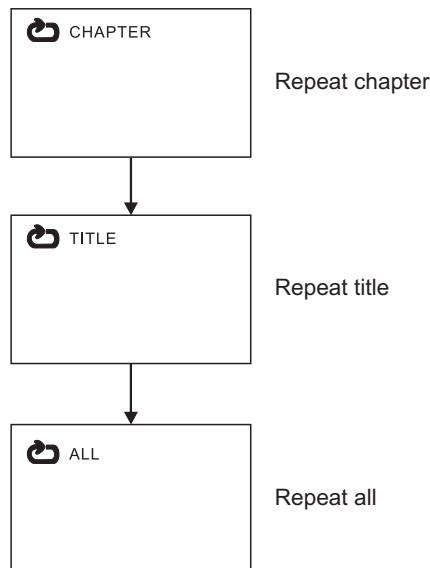

VCD/CD DISC (In the PBC OFF mode)

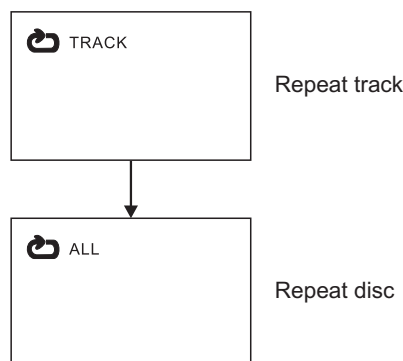

A-B repeat play

Repeating sections between two specific points (A-B repeat)

1. Press A-B REPEAT button during play at the point where repeat play is to be started (A).
2. Press A-B REPEAT button at the point where repeat play is to be ended (B). Repeat play of the selection between points A and B starts.
3. Press A-B REPEAT button to return to normal play.

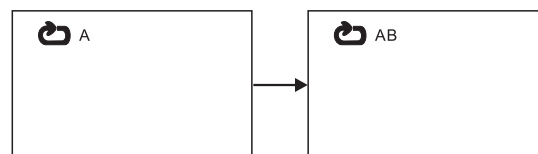

CHANGING SUBTITLE LANGUAGE (DVD ONLY)

It is possible to change the subtitle language to a different language from the one selected at the initial settings. (This operation works only with discs on which multiple subtitle languages are recorded)

1. Press SUBTITLE button during play, the screen will display the current language.
2. Press SUBTITLE button again to change language or turn off.

NOTE: When no subtitles are recorded, press this button will not work.

CHANGING SUBTITLE LANGUAGE

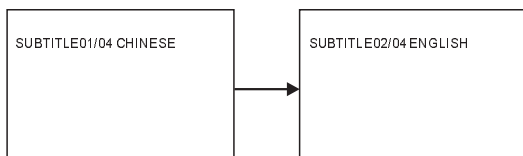

ZOOM PLAY

This function allow you to enjoy a motion or motionless picture.

- Press ZOOM button when playing, the screen shows:

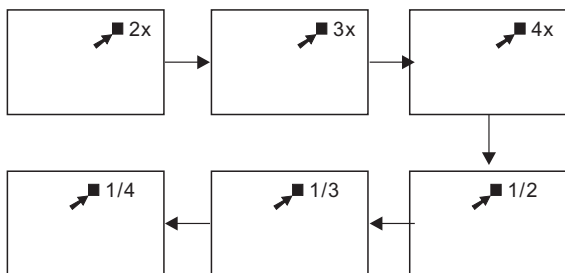

- Press NAVIGATION button to scroll across the enlarged picture.

CHANGING AUDIO SOUNDTRACK LANGUAGE(DVD/VCD DISC)

It is possible to change the audio soundtrack language to a different language from the one selected at the initial settings(This operation works only with discs on which multiple audio soundtrack languages are recorded).

- Press AUDIO button during playing DVD disc, the screen will display the number of current soundtrack language, press the button again will change the language.
- Pressing AUDIO button during playing VCD disc will change audio output mode: L audio soundtrack, R audio soundtrack and stereo (VCD disc only).

NOTE: When no soundtrack languages are recorded, press this button will not work.

NOTE: When the power is turned on or the disc is removed, the language heard is the one selected at the initial settings.

VIEWING FROM ANOTHER ANGLE (DVD ONLY)

Some DVDs may contain scenes which have been shot simultaneously from a number of different angles. For these discs, the same scene can be views from each of these different angles using the ANGLE button.

- Press ANGLE during play, number of angle being playback will be displayed in the screen, press the button will change to different angles.

SEARCH FOR PREFERRED SCENE

1. Press SEARCH button during play, then press up or down navigation button to select Title, Chapter, Title time or Chapter time to play.
2. Press SELECT button to confirm selection.
3. Enter the Title, Chapter, Title time or Chapter time to play by using the numeric buttons.
4. Press SEARCH button again to exit search mode.

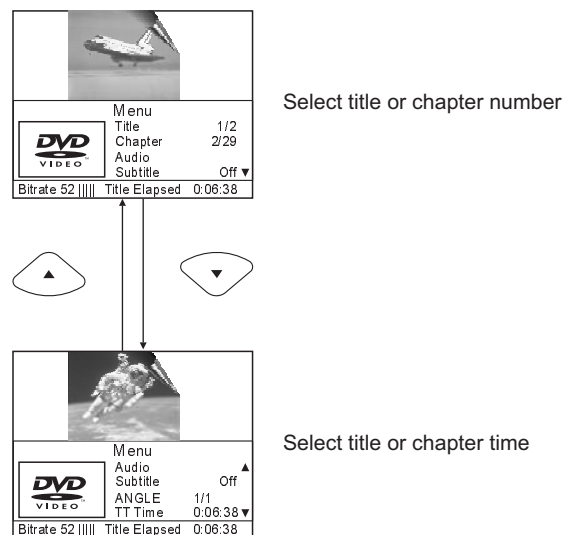

Note: TT Time = Title time
CH Time = Chapter time

MONITOR MAINTENANCE

Cleansing

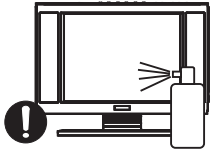

- Do not spray non-standard cleansing lotions directly on to the screen; this may damage the screen.



- Wipe the monitor with soft smooth cloth moistened with the cleansing lotion recommended; this can provide sufficient protection for the screen.

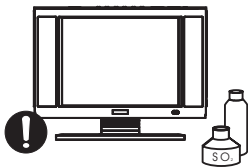

- Place the unit so it is way away from items such as a vase or chemicals: this may cause unwanted harm, electric shock or fire.



- Cleansing this housing with volatiliser, thinner or any corroding chemicals is prohibited as this unit contains plastic parts that are susceptible to corrosion or flammability when in contact with them.

Others

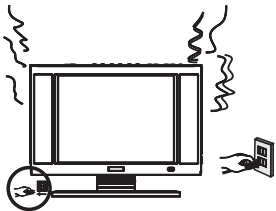

- Unplug the unit immediately it does not function correctly (for example, abnormal sound or blank screen or smoke). This could save you from the occurrence of a fire.

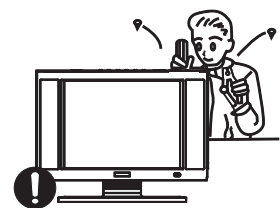

- Do not open the housing(through back cabinet) -- no serviceable parts are included; you could risk exposing yourself to live components. It may cause electric shock or fire.

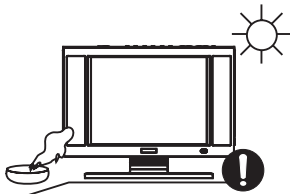

- Avoid exposing the monitor to moist dusty or smoky locations; Avoid direct sunlight or other heating sources. This may lead to malfunction of the monitor.



- Do not insert metal object of any kind into the openings of the monitor. This may result in electric shock, fire or injury.

TROUBLE SHOOTING

Before requesting service for this unit, please check the chart below for a possible cause of the problem you are experiencing.

Some simple check or adjustment on your own may eliminate the problem and restore proper operation.

Symptoms	Possible causes /Remedy
No picture or sound	Check to see if the AC power cable is plugged properly; Make sure the monitor is in play mode.
No picture	Make sure the channel is correctly selected; External TV antenna may be readjusted; Check if the external video input sources are connected.
No sound	Check whether the volume is set to low level or muted? Earphones is inserted into the earphones jack.
Dark Picture	Check the brightness and contrast settings
Unstable Picture	Adjust the direction of the aerial.
Double image	Angle is not correctly set.
Snowy display	ON/OFF interference
No color	Make sure the system settings are correct.
No subtitles.	Subtitles appear only with discs which contain them. Subtitles are cleared from the TV monitor, Perform the steps to display the subtitles.
Angle cannot be changed.	This function is dependent on software availability. Even if a disc has a number of angles recorded, these angles may be recorded for specific scenes only.
When in VGA input mode, the message "signal out of range" appears on the screen.	1. The default resolution of your PC should not exceed 1024X768. 2. The frame upgrade frequency should not exceed 75Hz, otherwise, this unit will not work in a normal way.