

Contents

Remote Control Buttons	2	Teletext	20
TFT TV	3	To Operate Teletext	20
Installation Of The TFT TV To The Wall	5	To Select A Page Of Teletext	21
Preparation	7	To Select Index Page	21
Features	7	To Select Teletext With A TV	
Panel Features	7	Programme	21
Safety Precautions	7	To Select Double Height Text	21
Before Switching On Your TV	9	To Reveal "Concealed" Information ...	21
Power Connection	9	To Stop Automatic Page Change	21
Connections To The RF Input Socket ..	9	To Select A Subcode Page	21
How To Connect Other Devices	9	Split Screen	22
Inserting Batteries In The Remote		To Exit Teletext	22
Control Handset	9	To Display The Time	22
Switching The TV ON/OFF	9	Fastext	22
To switch the TV on:	9	Connect Peripheral Equipment	22
To switch the TV off:	9	Via The Scart Socket	22
Operating The TV	10	Via Ant Input	22
Initial APS (Automatic Programming		TV And Video Recorder	23
System)	10	Playback NTSC	23
Operating with the buttons on the		Copy Facility	23
TV set	10	Search For And Store The Test Signal	
Operating With Remote Control	10	Of The Video Recorder	23
layout menu	11	Camera And Camcorder	23
picture menu	12	Connect a Decoder To a Video	
When VGA Or DVI Is Connected		Recorder	23
To TV:	12	Connecting Headphones	23
Window menu	13	Aerial Connections	24
When VGA Or DVI Is Connected		Tips	25
To TV:	13	Care Of The Screen	25
audio menu	14	Poor Picture	25
Options menu	15	No Picture	25
Settings menu	16	Sound	25
Aps menu	16	Remote Control	25
Program table	16	Specifications	26
Programming menu	18	Important Instruction	27
Source select	19		
Other Features	19		
TV Status	19		
Active window switch	19		
Programme Swap (SWAP)	20		
Freeze Picture	20		
Sound Indicator	20		
Mute Indicator	20		
AV Modes	20		

Remote Control Buttons

- ① = Stand By
- ② = Cursor Up
- ③ = Cursor Right
- ④ **OK** = Okay / Freeze
- ⑤ **0 - 9** = Numerical / Direct Program
- ⑥ = Image size
- ⑦ **SWAP** = Program / Source swap
- ⑧ **P/CH +** = Programme Up
- ⑨ = Volume Up
- ⑩ = TV / Quit Menu
- ⑪ **SOURCE** = Source select
- ⑫ = PIP size / YELLOW
- ⑬ = Split screen / BLUE
- ⑭ = Hold
- ⑮ = Update
- ⑯ = Index Page
- ⑰ = Reveal
- ⑱ = Expand
- ⑲ = Mix / Zoom-Pan
- ⑳ = Teletext
- ㉑ = Time / Subpage
- ㉒ = PIP / RED
- ㉓ = PIP position / GREEN
- ㉔ = Mute
- ㉕ **I-II** = Mono/Stereo - Dual A-B
- ㉖ = Volume Down
- ㉗ **- P/CH** = Programme Down
- ㉘ **P<P** = Previous Programme
- ㉙ = Info (Program Table)
- ㉚ **M** = Menu
- ㉛ = Cursor Down
- ㉜ = Cursor Left

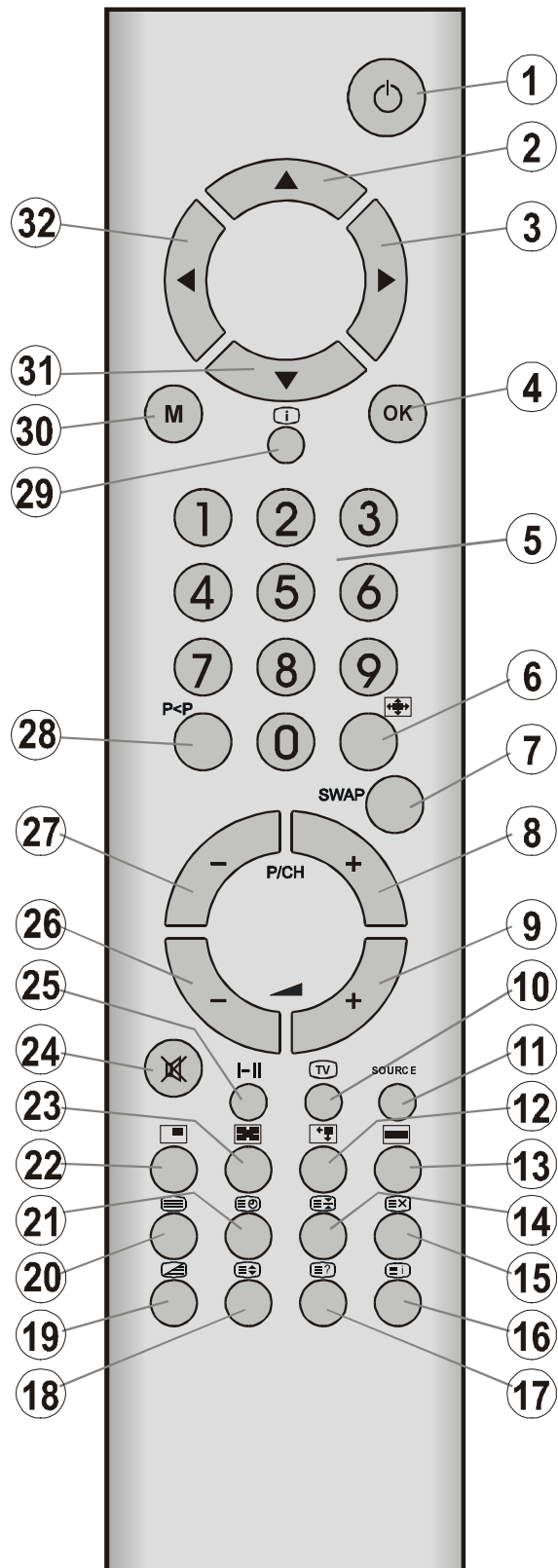

TFT TV

FRONT VIEW



REAR VIEW

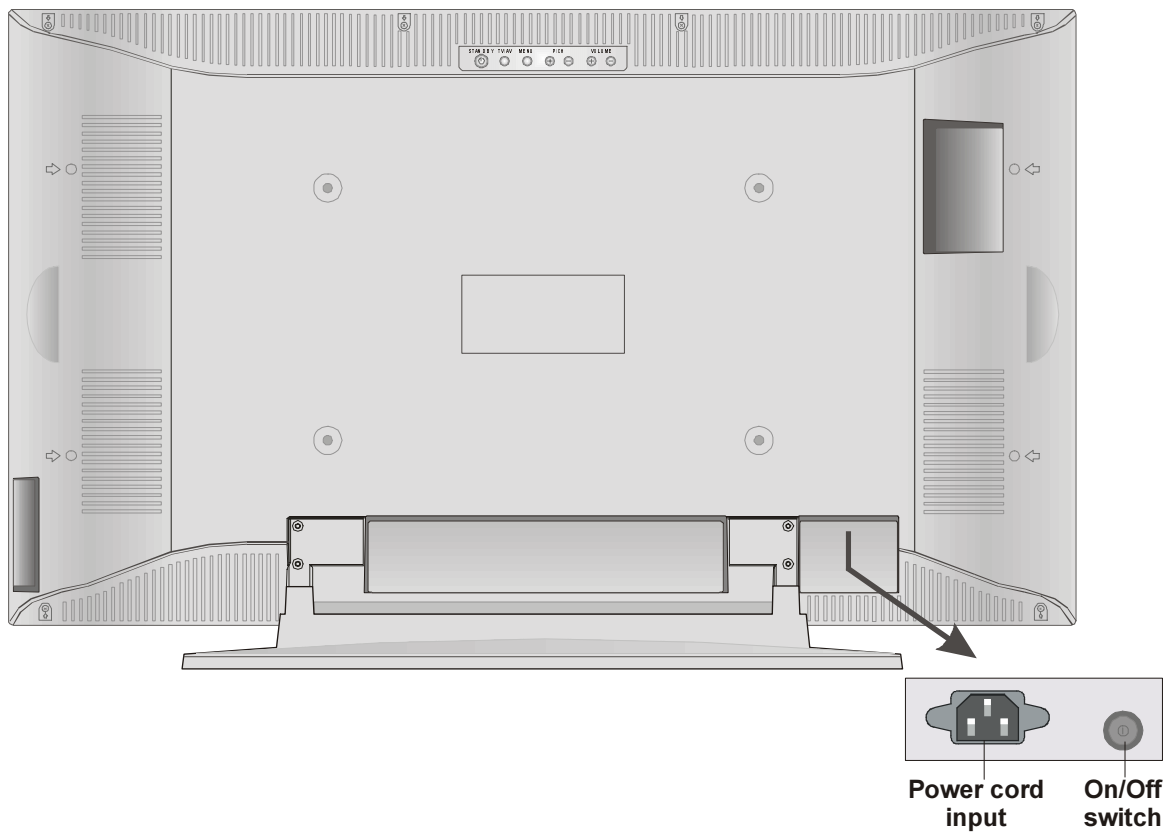

- Ⓐ Headphone
- Ⓑ Audio Input (Left, Right)
- Ⓒ Video Input
- Ⓓ S-VHS Input
- Ⓔ STAND BY button
- Ⓕ TV/AV button
- Ⓖ MENU button
- Ⓗ Program Up, Program Down buttons
- Ⓘ Volume Up, Volume Down buttons
- Ⓝ Power cord input
- Ⓚ On/Off switch
- Ⓛ Aerial
- Ⓜ Audio Line Out L, R
- Ⓝ Scart 1 } Full Scart
- Ⓞ Scart 2 }
- Ⓟ Audio In (for VGA and DVI source)
- Ⓡ DVI Input
- Ⓢ VGA Input

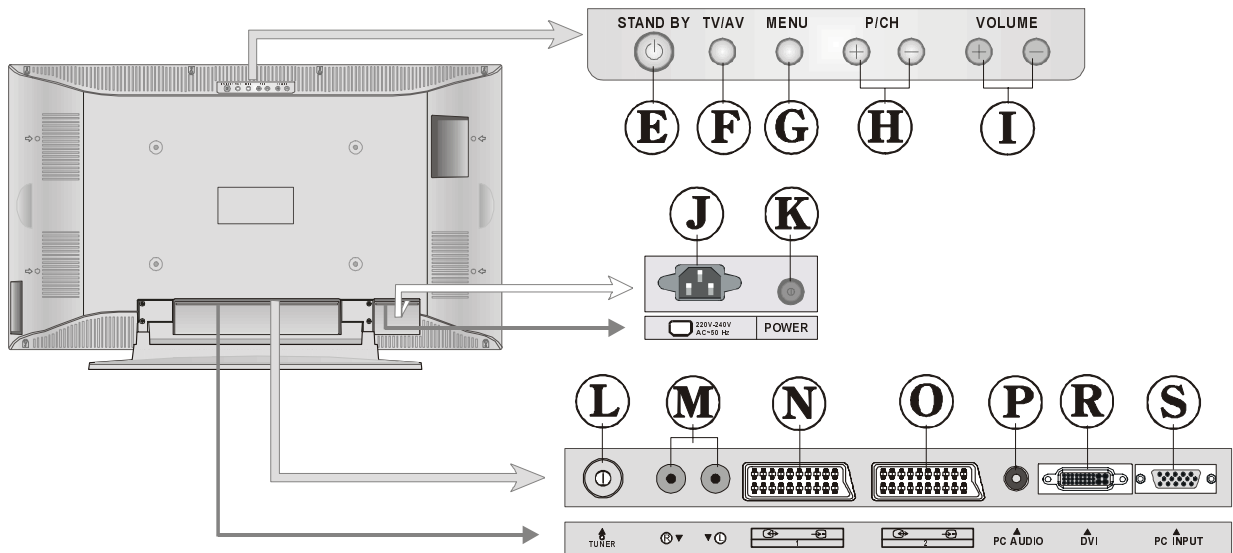
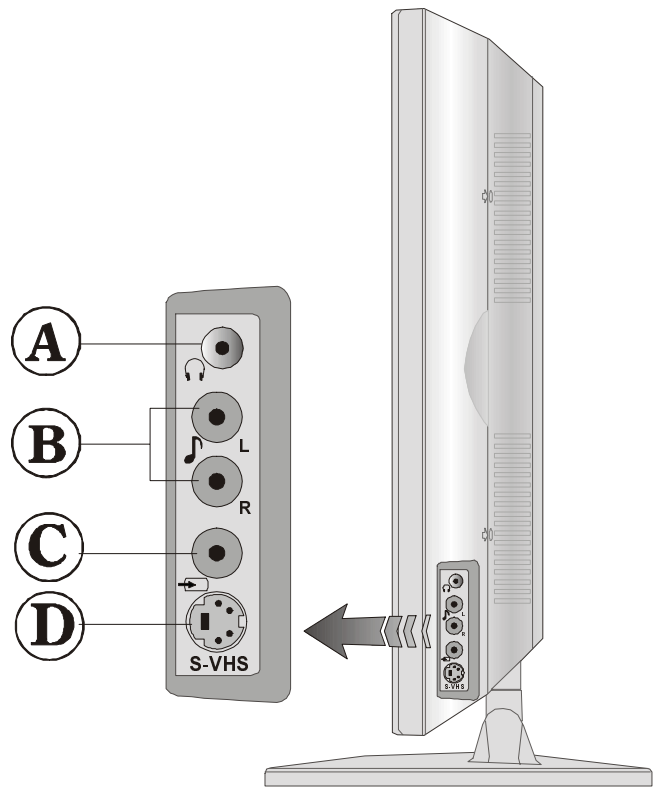

Installation Of The TFT TV To The Wall

1- To install the TFT TV on the wall, first of all, foot assembly should be removed. (Figure 1). Unscrew the 4 screws (M4 x 6) that attach the foot assembly to the TFT panel and remove the foot assembly from the TFT panel.

2- Place the 4 plastic pins to the circular screw holes at the rear of the TFT and screw them to the TFT panel with 4 (M6 x 20) screws.

3- Install the wall hanger as in figure 2 to the wall with 4 anchors (M7 x 30) and 4 screws (M4 x 30).

Decide the place on the wall where the TFT panel would be placed. Level and mark with a pencil the 4 mounting points on the wall hanger. Drill pilot holes for the plastic anchors and then fix the wall hanger with 4 screws (M4 x 30).

4- Raise the TFT panel and hang it to the holes on the wall hanger from the 4 hanging screws at the rear of the TFT panel.

Important note: This panel should only be hung on a brick or block wall, it must not be hung on a plasterboard or a stud wall.

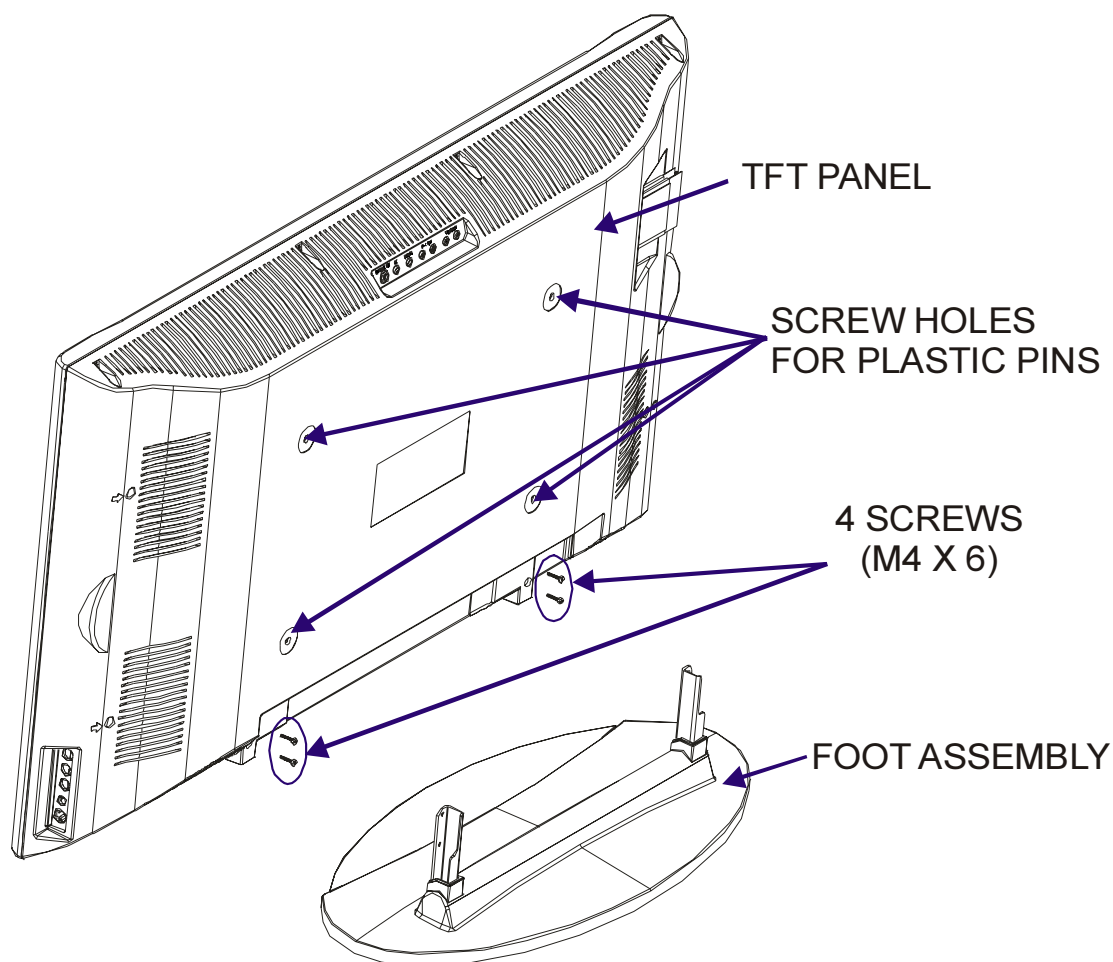

FIGURE 1

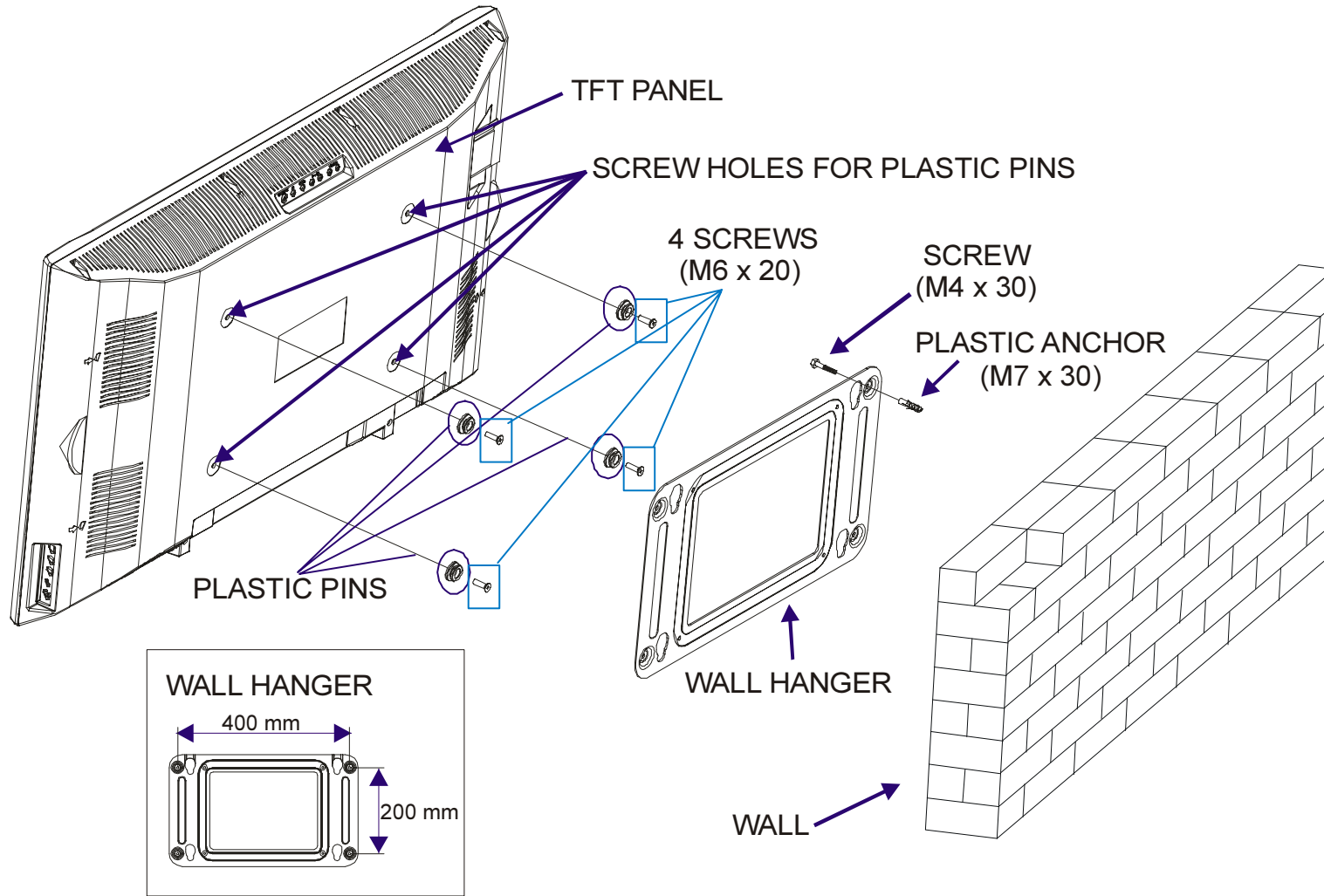

FIGURE 2

Preparation

For ventilation, leave a space of at least 10 cm free all around the set. To prevent any fault and unsafe situations, please do not place any objects on top of the set.

Features

- Remote controlled color television.
- 100 channels from VHF or UHF bands.
- It has 2 Scart sockets for external devices (such as video, video games, audio set, etc.)
- Stereo sound system (Nicom).
- Full function Teletext .
Fastext (10 Pages)
- Direct channel access.
- A.P.S. (Automatic Programming System).
- All channels can be named.
- Programme swapping between last watched and current channels.
- Sleep timer.
- Letterbox, 14:9, fill all (16:9), normal (4:3), Auto switch WSS (Wide Screen Signaling).
- Side SVHS socket.
- Side AV socket.
- VGA and DVI connectors for external devices such as computer.
- AVL (Automatic Volume Limiting)
- Picture in Picture.
- When no valid signal is detected, after 5 minutes the TV switches itself automatically to stand-by mode.
- PC input (Support Up to WXGA 1280 x 768)
- Headphone output.
- Stereo PC Audio Input
- Audio Line Out

Panel Features

- High resolution, 30-inch TFT LCD display.
- WXGA resolution (1280 x 768)
- Contrast ratio (600:1 typical)

- Brightness (typical) 550 cd/m²
- Response time (typical) 16 msec.
- Viewing angle (typical) 170° (horizontal) and 170° (vertical).
- Display color 16.7 Million.

Safety Precautions

1. Power Source

The receiver should be operated only from a **230-240V AC, 50 Hz.** outlet. Ensure you select the correct voltage setting for your convenience.

2. Power Cord

The power supply cord should be placed so that it is not likely to be walked on or pinched by items placed upon them or against it. Pay particular attention to cord where it enters the plug, power outlet, and the point where it exits from the receiver.

3. Moisture and Water

Do not use this equipment in a humid and damp place (avoid the bathroom, the sink in the kitchen, and near the washing machine). Do not expose this equipment to rain or water, as this may be dangerous and do not place objects filled with liquids on top. Avoid from dripping or splashing.

4. Cleaning

Before cleaning, unplug the receiver from the main supply, outlet. Do not use liquid or aerosol cleaners. Use soft and dry cloth.

5. Ventilation

The slots and openings on the receiver are intended for ventilation and to ensure reliable operation. To prevent overheating, these openings must not be blocked or covered in anyway.

6. Lightning

In case of storm and lightning or when going on holiday, disconnect the power cord from the wall outlet.

7. Replacement Part

When replacement parts are required, be sure the service technician has used replacement parts which are specified by the manufacturer or have the same specifications as the original one. Unauthorised substitutions may result in fire, electrical shock, or other hazards.

8. Servicing

Please refer all servicing to qualified personnel. Do not remove cover as this may result in electric shock.

9. Naked Flame Sources

Do not place naked flame sources on the apparatus.

WARNING: When the device is not in use for a long time, disconnect from power.

Instructions for waste disposal:

- Packaging and packaging aids are recyclable and should principally be recycled. Packaging materials, such as foil bag, must be kept away from children.
- Battery, including those which is heavy metal-free, should not be disposed of with household waste. Please dispose of used battery in an environmentally sound manner. Find out about the legal regulations which apply in your area.
- Cold cathode fluorescent lamp in LCD PANEL contains a small amount of mercury, please follow local ordinances or regulations for disposal.

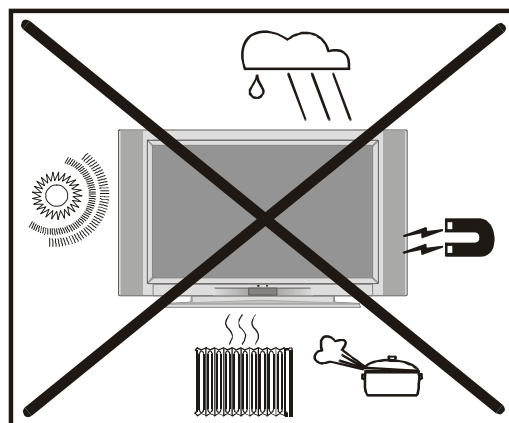
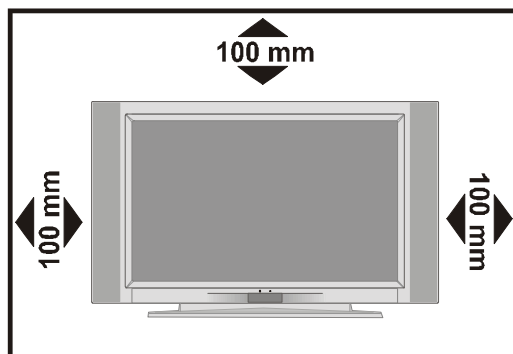

"The LCD panel is very high technology product with about a million thin film transistors, giving you fine picture details. Occasionally, a few non-active pixels may appear on the screen as a fixed point of blue, green or red. Please note that this does not affect the performance of your product."

"DO NOT LEAVE YOUR TV AT STAND-BY OR OPERATING WHEN YOU LEAVE YOUR HOUSE"

Before Switching On Your TV

Power Connection

IMPORTANT: The TV set is designed to operate on **230-240V AC, 50 Hz**.

- After unpacking, allow the TV set to reach the ambient room temperature before you connect the set to the mains.

Connections To The RF Input Socket

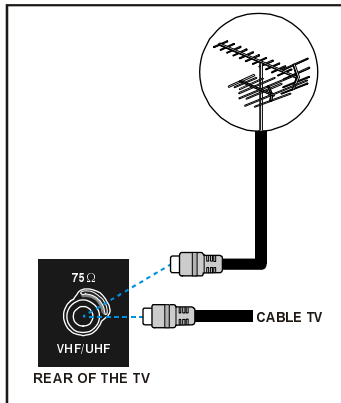

- Connect the aerial or cable TV plug to the RF input socket located at the back of the TV.

How To Connect Other Devices

IMPORTANT: Switch off the TV before connecting any external device.

Sockets for external connections are at the back and side of the TV. For connection of other devices via **scart** refer to the manuals of the related devices.

Inserting Batteries In The Remote Control Handset

- Insert the batteries observing the correct polarities as shown below.
- Remove the battery cover located on the back of the handset by gently pulling upwards from the indicated part.
- Insert two **AAA** or equivalent type batteries inside.
- Replace the battery cover.

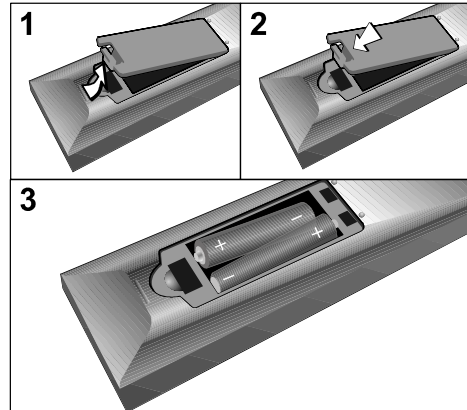

NOTE: Remove batteries from remote control handset when it is not to be used for a long period. Otherwise it can be damaged due to any leakage of batteries.

Switching The TV ON/OFF

To switch the TV on:

1- Connect the power supply cord to the system. Press On/Off switch at the rear of the TV. Then the TV switches itself to stand-by mode and the **LED** becomes red located on the front of the TV.

2- To switch on the TV from stand-by mode either:

Press a digit button on the remote control so that a programme number is selected,

or,

Press “**⏻**”, “**-P/CH**” or “**P/CH+**” button at the top of the TV or press “**-P/CH**” or “**P/CH+**” button on the remote control.

The TV will switch on and the LED will turn green.

To switch the TV off:

• Press the “stand-by” button on the remote control, so the TV will switch to stand-by mode and the **GREEN LED** will turn **RED**,

or,

Press the “**⏻**” button located on the top of the TV, so the TV will switch off and the **GREEN LED** will turn **RED**.

To power down the TV completely, press On/Off switch,

or

unplug the power cord from the mains socket.

Operating The TV

You can operate your TV both using the remote control handset and onset buttons.

Initial APS (Automatic Programming System)

The following menu will be displayed on the screen when you turn on your TV for the first time. APS, searches and sorts all channels and stores them automatically on your TV.

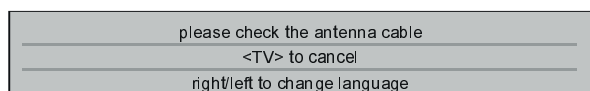
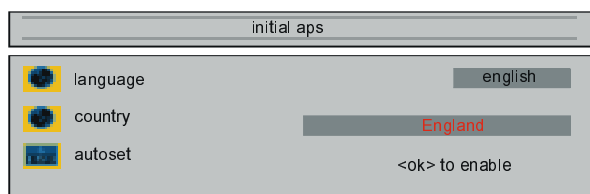

To cancel APS before starting, press "TV" button. First of all choose **language** and **country** by using "▲" / "▼" and "◀" / "▶" buttons. This, will effect the sort process in APS. To start aps select **autose**, by using "▲" / "▼" buttons and press "◀" / "▶" or "OK" button.

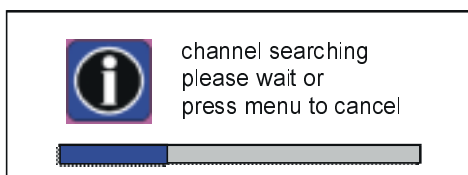

After APS is **finalised**, the programme table will **show** on the screen. In the programme table you will see the programme numbers and names assigned to the programmes.

If you do not accept the locations and / or the programme names of programmes, you can change them in **tuner** submenu in the settings menu. (See page 17 for Program table explanation.)

To exit programme table press "M".

Operating with the buttons on the TV set

Volume setting and programme selection can be made by using the buttons at the control panel on the top of the TV.

Volume Setting

Press "VOLUME -" button to decrease volume or "VOLUME +" button to increase volume, a volume level scale (slider) will be displayed at the middle of the bottom on the screen.

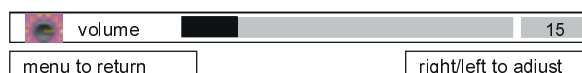

Programme Selecting

Press "P/CH+" button to select the next programme or "PCH-" button to select the previous programme.

Entering The Menu

Press "MENU" button at the control panel on the top of the TV to enter the menu.

"P/CH+ / PCH-" and "VOLUME + / VOLUME -" buttons at the control panel on the top of the TV work as direction buttons in the menu.

AV Mode

Press "TV / AV" button at the control panel on the top of the TV to switch your TV to AV mode (See **AV Modes** on page 20).

Operating With Remote Control

The remote control handset of your TV is designed to control all the functions of the **TV model you selected**. The functions will be described in accordance with the menu system of your TV.

Functions of the menu system are described in Menu System section.

Volume Setting

Press "▲ +" button to increase volume. Press "- ▼" button to decrease volume. A volume level scale (slider) will be displayed at the **centre bottom** on the screen.

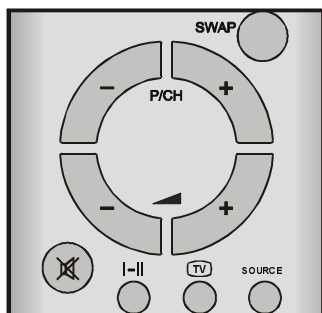

Programme Selecting

(Previous or next programme)

- Press “- P/CH” button to select the previous programme.
- Press “P/CH +” button to select the next programme.

Programme Selecting (direct access):

Press **numerical** buttons on the remote control handset to select programmes between 0 and 9. TV will switch to the selected program after a short delay.

- For a two digit program number enter the second digit within 2 seconds after pressing the first digit.

Menu System

Press the “**M**” (**MENU**) button to enter the menu. “**M**” button has two functions. The first function is open and close the menu, the second function is closing the submenu and then opening its parent menu.

Press “◀” / “▶” button to select a menu title and then “▲” / “▼” button to select a menu item and “◀” / “▶” or “OK” button to **enter accept** the menu item. To exit a menu press “**M**” button.

layout menu

By pressing “◀” / “▶” button, select the first icon. Layout menu **is shown** on the screen.

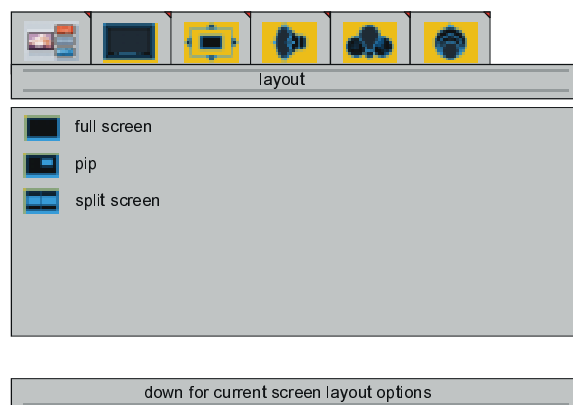

Full screen

By pressing “▲” / “▼” button, select **full screen**. Press “OK” the current source will be displayed full screen.

pip (picture in picture)

Using “▲” / “▼” button, select **pip**. Press “OK” the first programme from the tuner 1 can be watched on the background. The second programme from the tuner 2 **is shown in the pip window**.

To activate PIP layout directly press the “” (RED) button on the remote control.

Split screen

Using “▲” / “▼” button, select **split screen**. Press “OK” the picture from the channel selected on tuner 2 will be shown on the left hand half of the screen. The picture from the channel selected on tuner 1 will be shown on the right hand half of the screen.

To activate Split Screen layout directly press the “” (BLUE) button on the remote control.

Use the “▲” / “▼” , “◀” / “▶” to select the window to listen to or adjust.

 sign is displayed in the activated window. The sound of the picture at the selected window is heard and all menu functions are only valid for this window. All the buttons (except stand-by and “▲ +” / “- ▲”) on the remote control and the TV are only active for this window.

Press “**M**” button to exit layout menu.

Picture menu

Using “◀” / “▶” buttons, select the second icon. Picture menu appears on the screen.

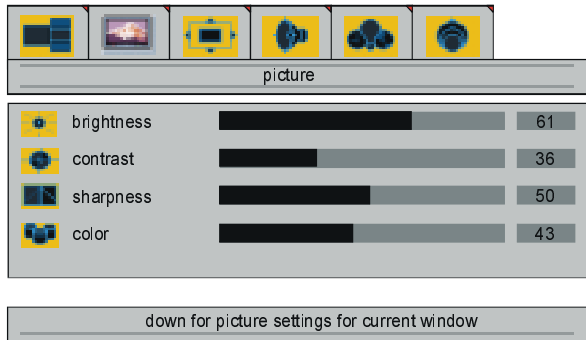

Brightness

Using “▲” / “▼” buttons, select **brightness**. “right/left to adjust brightness” is shown on the screen. Press “▶” button to increase brightness. Press “◀” button to decrease brightness. Brightness level can be adjusted between 0 and 100.

Contrast

Using “▲” / “▼” buttons, select **contrast**. “right/left to adjust contrast” is shown on the screen. Press “▶” button to increase contrast. Press “◀” button to decrease contrast. Contrast level can be adjusted between 0 and 100.

Sharpness

Using “▲” / “▼” buttons, select **sharpness**. “right/left to change sharpness” is seen on the screen. Press “▶” button to increase sharpness. Press “◀” button to decrease sharpness. Sharpness level can be adjusted between 0 and 8.

Colour

Using “▲” / “▼” buttons, select **color**. “right/left to adjust color” is seen on the screen. Press “▶” button to increase **colour**. Press “◀” button to decrease **colour**. **Colour** level can be adjusted between 0 and 100.

Tint

This item is displayed in picture menu when TV is in AV mode and **with an NTSC source**. By pressing “▲” / “▼” button, select **tint**.

“right/left to adjust tint” is seen on the screen. Press “▶” button to increase tint. Press “◀” button to decrease tint. Tint level can be adjusted between 0 and 100.

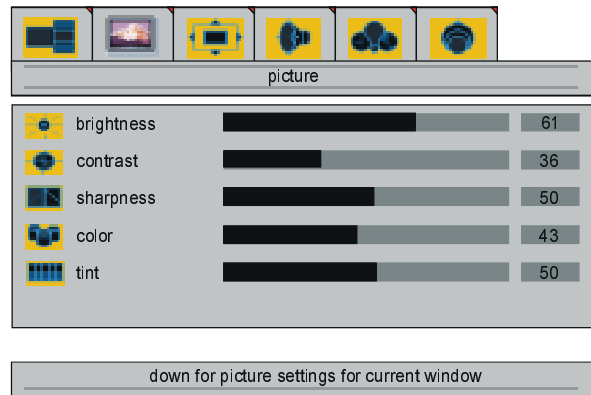

When TV is in AV mode; picture menu items (brightness, contrast, sharpness and color) may require re-adjustment.

When VGA Or DVI Is Connected To TV:

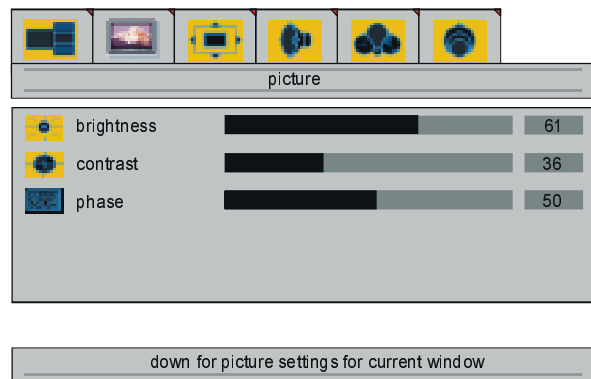

Brightness

Using “▲” / “▼” buttons, select **brightness**. “right/left to adjust brightness” is shown on the screen. Press “▶” button to increase brightness. Press “◀” button to decrease brightness. Brightness level can be adjusted between 0 and 100.

Contrast

Using “▲” / “▼” buttons, select **contrast**. “right/left to adjust contrast” is shown on the screen. Press “▶” button to increase contrast. Press “◀” button to decrease contrast. Contrast level can be adjusted between 0 and 100.

Phase

This item is **only** available in the picture menu when DVI is connected to the TV.

Using “▲” / “▼” buttons, select **phase**. “right/left to adjust phase” is shown on the screen. Press “▶” button to increase phase. Press “◀” button to decrease phase. Phase level can be adjusted between 0 and 100.

Window menu

By pressing “◀” / “▶” button, select the third icon. Window menu is shown on the screen.

- If full screen option was selected at the layout menu, the window menu is shown as below.

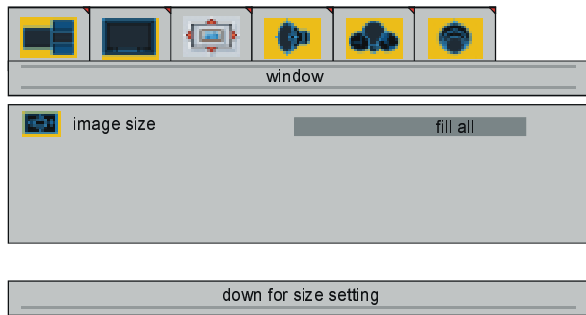

Image size

Using “▲” / “▼” buttons, select **image size**. “right/left to change image size” is seen on the screen. By pressing “◀” / “▶” button, you can change image size to **fill all**, **zoom**, **letterbox**, **subtitles**, **normal**, **14:9** and **auto**.

You can enter image size directly by pressing “⏏” button.

- If pip option was selected, the window menu is seen as below.

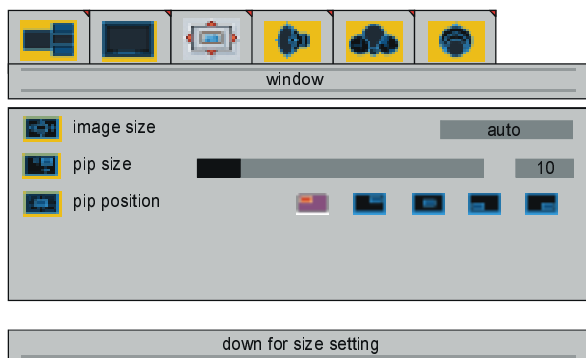

Image size

Using “▲” / “▼” buttons, select **image size**. “right/left to change image size” is shown on the screen. By pressing “◀” / “▶” button, you can change image size to **fill all**, **normal** and **auto**.

You can change image size directly by using “⏏” button on the remote.

Pip size

Using “▲” / “▼” buttons, select **pip size**. “right/left to adjust PIP size” is shown on the screen. Press “▶” button to increase pip size. Press “◀” button to decrease pip size. Pip size can be adjusted between 0 and 100.

You can change the pip size directly by pressing “⏏” (YELLOW) button on the remote.

Pip position

Using “▲” / “▼” buttons, select **pip position**. “right/left to adjust PIP position” is shown on the screen. By pressing “◀” / “▶” buttons, you can change the pip position as left top, right top, middle, left bottom or right bottom (as shown on the menu above).

You can change pip position directly by pressing “⏏” (GREEN) button on the remote.

When VGA Or DVI Is Connected To TV:

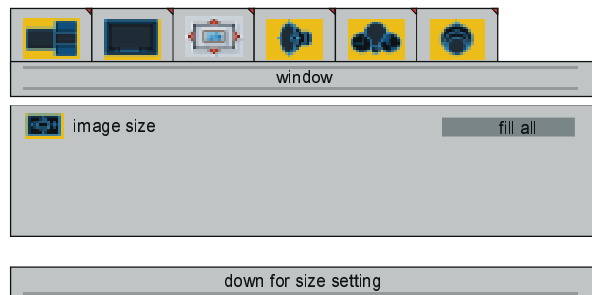
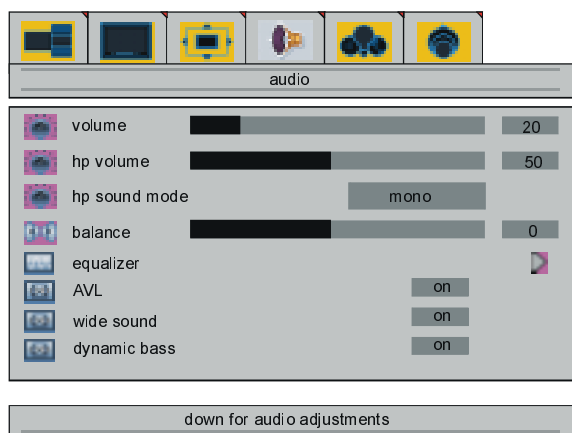

Image size

Using “▲” / “▼” buttons, select **image size**. “right/left to change image size” is seen on the screen. By pressing “◀” / “▶” buttons, you can change image size to **fill all**, **fill 1:1** and **fill aspect**.

Audio menu

Using “◀” / “▶” buttons, select the fourth icon. Audio menu is shown on the screen.



Volume

Using “▲” / “▼” buttons, select **volume**. "right/left to adjust volume" is shown on the screen. Press “▶” button to increase volume level. Press “◀” button to decrease volume level. Volume level can be adjusted between 0 and 63.

Headphone volume

Using “▲” / “▼” buttons, select **hp volume**. "right/left to adjust hp volume" is shown on the screen. Press “▶” button to increase hp volume level. Press “◀” button to decrease hp volume level. Hp volume (headphone volume) level can be adjusted between 0 and 100.

Headphone sound mode

Using “▲” / “▼” buttons, select **hp sound mode**. "right to adjust hp sound mode" is shown on the screen. Press “▶” button change hp sound mode.

Hp sound mode is used to identify sound mode of the headphone. hp sound mode can be set to **mono**, **stereo**, **dual a** or **dual b** according to the transmission.

Balance

Using “▲” / “▼” buttons, select **balance**. "right/left to adjust balance" is shown on the screen. Press “▶” button to increase balance towards the right. Press “◀” button

to increase balance towards the left. Balance level can be adjusted between -50 and 50.

Equalizer

Using “▲” / “▼” buttons, select **equalizer**. "right/left for equalizer settings" is shown on the screen. Press “◀” / “▶” or “OK” button to enter equalizer menu. In equalizer menu the sound mode can be changed to **user**, **flat**, **pop**, **rock**, **jazz** and **classic** by pressing “◀” / “▶” buttons. Equalizer menu settings can be changed only when **sound mode** is **user**. Select the desired frequency using “▲” / “▼” buttons and increase or decrease the frequency gain by pressing “◀” / “▶” buttons.

Press “M” button to exit the equalizer menu.

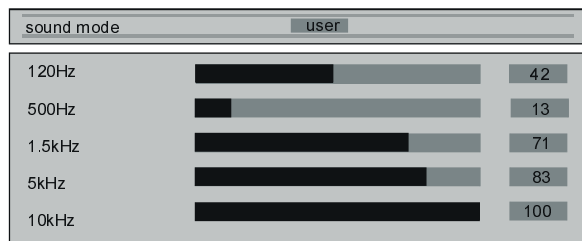

AVL

Using “▲” / “▼” buttons, select **AVL**. "right/left for AVL on/off" is shown on the screen. Using “◀” / “▶” buttons set AVL **on** to activate it or **off** to deactivate it.

Wide sound

Wide Sound is used to give a wide effect to the sound.

Using “▲” / “▼” buttons, select **wide sound**. "right/left for wide sound off/stereo/mono" is shown on the screen. By pressing “◀” / “▶” button set choose **off** / **stereo** / **mono**.

Dynamic bass

Dynamic Bass is used to increase bass effect of the TV set.

Using “▲” / “▼” buttons, select **dynamic bass**. "right/left for dynamic bass on/off" is shown on the screen. By pressing “◀” / “▶” buttons set to dynamic bass **on** to activate it or **off** to deactivate it.

Options menu

Using “◀” / “▶” buttons, select the fifth icon. Options menu is shown on the screen.

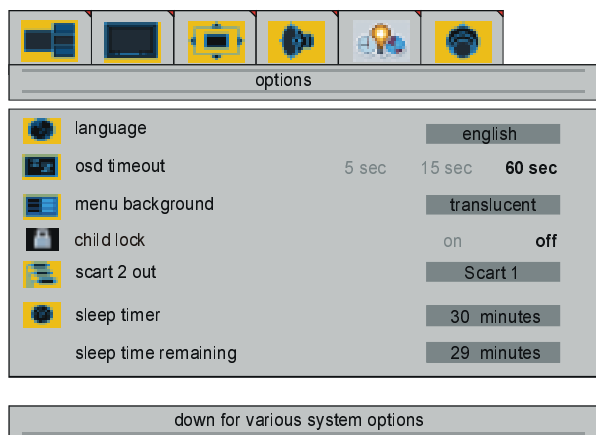

Language

Using “▲” / “▼” buttons, select language. "right/left to change language" is shown on the screen. By pressing “◀” / “▶” button, you can select the language.

Vcr

This item is displayed only when TV is in AV mode. Using “▲” / “▼” buttons, select vcr. "right/left to change vcr status" is shown on the screen. Using “◀” / “▶” buttons set vcr to on or off.

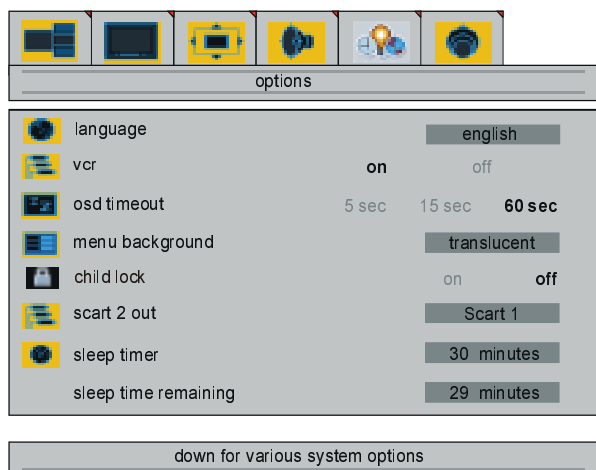

Osd timeout

Set the time until the osd items are removed from the screen.

Using “▲” / “▼” buttons, select osd timeout.

"right/left to change osd timeout" is shown on the screen. By pressing “◀” / “▶” buttons, you can change osd timeout to 5 sec, 15 sec or 60 sec.

Menu background

Using “▲” / “▼” buttons, select menu background. "right to change menu background" is shown on the screen. You can change menu background to translucent or opaque by pressing “▶” button.

Child lock

You can use this feature to prevent children turning on TV or changing programs or adjustments etc. without the remote control.

Using “▲” / “▼” buttons, select child lock. "right/left to change" is shown on the screen. The child lock feature can be set by “◀” or “▶” button to either on or off. When off is selected, there will be no difference in the operation of your TV. When on is selected, the TV can only be controlled by the remote control handset.

Scart 2 out

Using “▲” / “▼” buttons, select scart 2 out. "right/left to select scart 2 out" is shown on the screen. You can set scart 2 out to Scart 1, Tuner or FAV by using “◀” / “▶” buttons.

Sleep timer

The sleep timer is used to turn the TV off after a pre-defined period.

Using “▲” / “▼” buttons, select sleep timer. "adjust sleeptimer" is shown on the screen. You can set the sleep time to Off, 15, 30, 60, 90 or 120 minutes by pressing “◀” / “▶” button.

Sleep time remaining

Selected and remaining sleep time is displayed at this area. Sleep time remaining item can not be selected by “▲” / “▼” buttons.

Settings menu

Using “◀” / “▶” buttons, select the sixth icon. Settings menu appears on the screen.

- If full screen option is selected in the layout menu, the settings menu is as shown below.



down for various system settings

- If pip or split screen option was selected at the layout menu or in AV mode, the settings menu is as shown below.

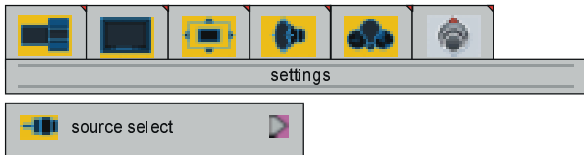

down for various system settings

Tv tuner

Using “▲” / “▼” buttons, select **tv tuner**. “<ok> to activate tuner menu” is shown on the screen. Using “◀” / “▶” or “OK” buttons enter the menu. **tv tuner** menu has two sub-menu named as **aps** and **programming**.

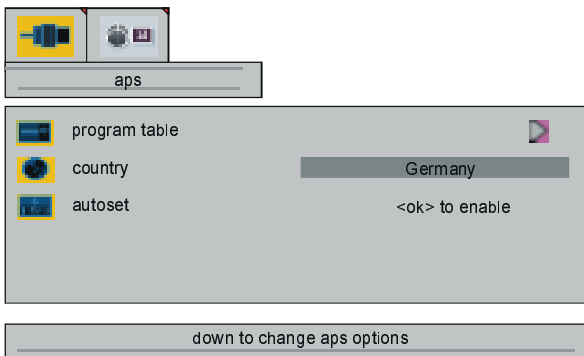

down to change aps options

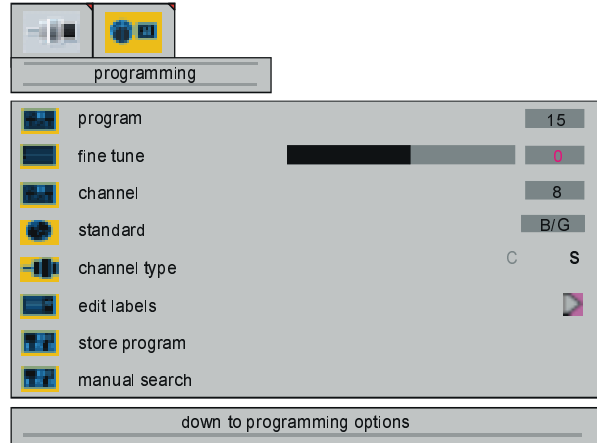

down to programming options

Aps menu

Using “◀” / “▶” buttons in tv tuner menu select the second icon. aps menu appears on the screen.

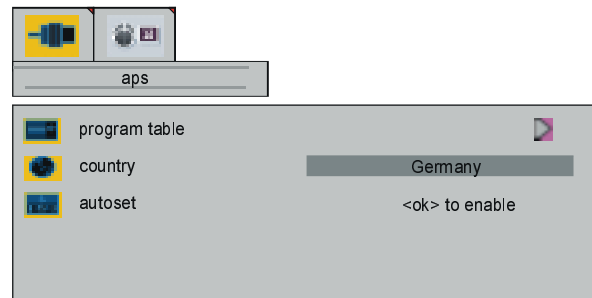

down to change aps options

Program table

Using “▲” / “▼” buttons, select **program table**. “right/left to enter program table” is shown on the screen. By pressing “◀” / “▶” or “OK” button, you can enter the following program table.

Programme table is also entered directly by pressing “i” button on remote.

- Program table may be entered only when the layout is **full screen**. You can not enter to program table when layout is **pip** or **split screen**.

program table		
1 CNN	11 ----	21 ----
2 RA12	12 ----	22 ----
3 SAT	13 ----	23 ----
4 RA13	14 ----	24 ----
5 TV5	15 ----	25 ----
6 ZDF	16 ----	26 ----
7 RA1	17 ----	27 ----
8 C02	18 ----	28 ----
9 S07	19 ----	29 ----
10 C05	20 ----	30 ----

 Delete
  Insert
  Name

Using the direction keys you can select any 1 of the 30 channels shown on the programme table. By scrolling the pages up or down by pressing the navigation buttons you can select all the programmes in TV mode (except the AV mode).

In program table, “▲” / “▼” buttons work like "Direction Up" and "Direction Down".

Programme Number is between 01 and 99. 00 is not displayed on program table. Programme Name has a name string with 5 characters. After autoselect process the Programme Names are set to "C02" or "S07" (channel type and channel number) or name of the tuned channel if defined.

At the bottom of the program table there is a programme sort functions section. Each function is activated by color button (shown above). **Insert** section is for inserting programmes into another programme spaces. **Name** allows changing the programme name.

Delete:

To delete a channel use the direction keys to select the channel and then press Use RED button. Press “OK” to confirm delete or press “M” button to cancel.

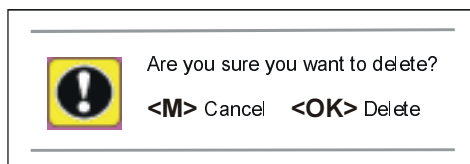

Insert:

Select the program which you want to insert by navigation buttons. Press GREEN button. Using the navigation buttons move the se-

lected program to the required programme space and press GREEN button again.

Name:

To change the name of a selected programme. Use navigation keys to select that programme and press the YELLOW button. The following menu is shown on the screen.

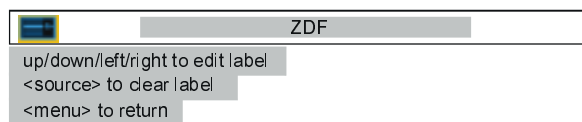

The first letter of the selected name is highlighted. To change that letter use the “▲” / “▼” buttons, and to select the other letters, use the “◀” / “▶” buttons. If the cursor is at the last letter of the Programme Name, pressing “▶” button moves the cursor back to the beginning. If the cursor is at the beginning of the Programme Name, pressing “◀” button moves the cursor to the end.

Country

Using “▲” / “▼” buttons, select country. "right/left to change country" is shown on the screen. By pressing “◀” / “▶” button, you can select the country where you are.

Autoset

Using “▲” / “▼” buttons, select autoset. "right/left to start aps function" is shown on the screen. When “◀” / “▶” or “OK” button is pressed, the following menu is shown on to the screen. If you want to cancel autoset function, press “M” button. You return to aps menu.

If you press “M” button after autoset is started, program table is shown on the screen.

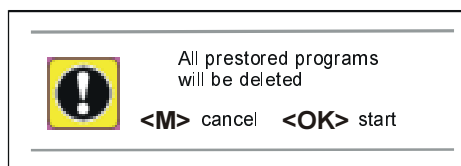

If “OK” button is pressed, autoset function starts and the following popup is shown on the screen.

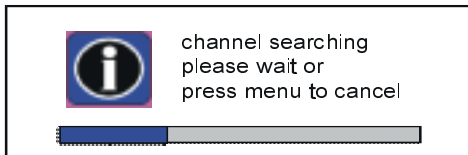

After autiset is finalized, the program table comes to the screen.

Programming menu

Using “◀” / “▶” button in tv tuner menu select the first icon. Programming menu is shown on the screen.

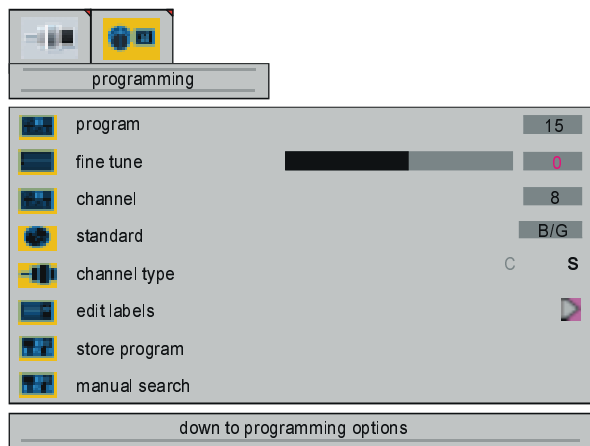

Program

Using “▲” / “▼” buttons, select program. "right/left to select program" is shown on the screen. By pressing “◀” / “▶” button, you can select the program number. You can also enter a number using the numerical buttons on the remote control. There are 100 program that can be stored between 0 and 99.

Fine tune

Using “▲” / “▼” buttons, select fine tune. "right/left to adjust fine tuning" is shown on the screen. By pressing “◀” / “▶” buttons, you can fine adjust the tuning. The adjust values are between -50 and +50.

Channel

Using “▲” / “▼” buttons, select channel. "right/left to change channel" is shown on the screen. By pressing “◀” / “▶” buttons, you can change the channel number. You can also enter a number using the numeri-

cal buttons on the remote control. The adjust values change according to the **standard** and **channel type**.

Standard

Using “▲” / “▼” buttons, select standard. "right/left to change standard" is shown on the screen. By pressing “◀” / “▶” buttons, you can change the standard to B/G, D/K, I or L/L'.

Channel type

Using “▲” / “▼” buttons, select channel type. "right/left to change channel type" is shown on the screen. By pressing “◀” / “▶” button, you can change the channel type to C or S.

Edit labels

Using “▲” / “▼” buttons, select edit labels. "right/left to edit labels" is shown on the screen. By pressing “◀” / “▶” or “OK” button, the following pop-up is shown on the screen.

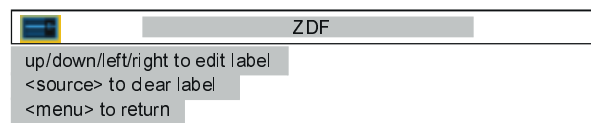

“▲” / “▼” or “◀” / “▶” buttons are used to edit labels.

Store program

Using “▲” / “▼” buttons, select store program. "right/left to store program" is shown on the screen. By pressing “◀” / “▶” or “OK” buttons, you can store the changes made and following menu will be shown on the screen.

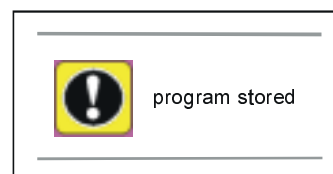

Manual search

Using “▲” / “▼” buttons, select manual search. "right/left to search" is shown on the screen. By pressing “◀” or “▶” button,

you can start programme searching and the following menu is shown on the screen.



Source select

Using “▲” / “▼” buttons, select source select in settings menu. “<ok> to activate source selection menu” is shown on the screen. By pressing “◀” / “▶” or “OK” button, you can enter the source select menu.

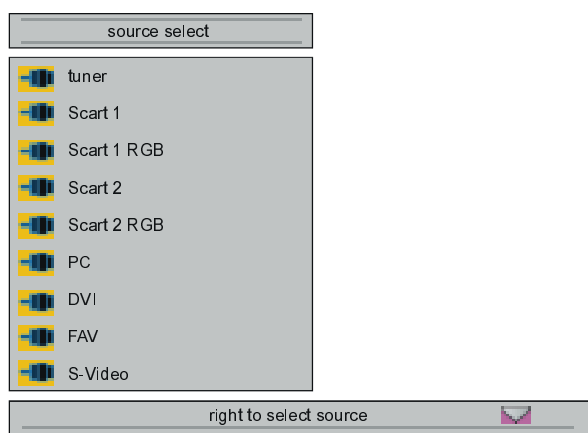

In source select menu, Use the “▲” / “▼” buttons to highlight the required source and select it by pressing “▶” button. The source types are tuner, Scart 1, Scart 1 RGB, Scart 2, Scart 2 RGB, PC, DVI, FAV and S-Video.

Other Features

TV Status

Programme Number, Programme Name and Sound Indicator are displayed on the upper right side of the screen. Source is also displayed with them on the right bottom side of the screen. They are displayed after programme change during 3 seconds.

P 01 Programme Number

PR_01 Programme Name (5 characters)

These OSD's are displayed when a new programme is entered by digit button, by pressing “P<P” button or “-P/CH” or “P/CH+” button or “TV” button.

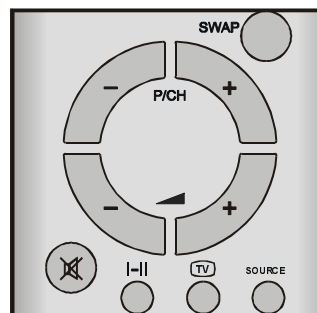

Previous Programme

- Press "P<P" (Previous Programme) button to select the last selected programme. This button provides swapping between last two selected programmes. For example, select programme 8, then select programme 2. Now, if you press "P<P" button, programme 8 will be selected. If you press the same button again, programme 2 will be selected and so on.



Active window switch

In PIP and PAP modes “▲” and “▼” buttons are used to select active window. “◀” and “▶” cursors are used to show the sound status of the active window.

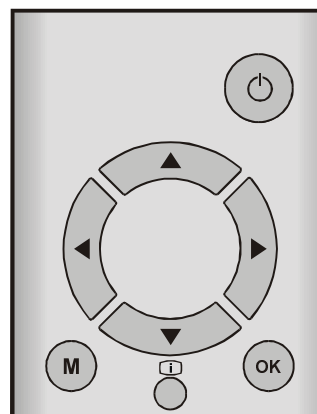

Programme Swap (SWAP)

This button is used to swap between the programmes in the PIP window and main picture if the screen layout is selected as **PIP**.

It is not possible to display PC screen on the PIP screen.

Freeze Picture

You can freeze the picture on the screen by pressing "OK" button. Display layout should be selected as **full screen** for this feature. At **split screen** and **PIP** layouts; this feature is not possible.

Sound Indicator

The alternatives of the indicator are **Mono**, **Stereo**, **Dual A** and **Dual B**. This indicator is displayed under the programme number indicator on the screen. "I-II" button is used to select **Mono**, **Stereo**, **Dual A** or **Dual B**.

In **Mono** broadcast or in forced-mono (for stereo broadcast).

MONO

In **Stereo** broadcast.

STEREO

If dual broadcast detected. **Dual A** is selected in default.

DUAL A

If **Dual B** selected by Remote Control.

DUAL B

Mute Indicator

It is placed in the upper left side of the screen when **activated**.



To cancel mute, there are two alternatives, the first one is **press the "Mute" button**, the volume is set to the preceding value, and the second one is **increasing/decreasing the volume level using "- ▲" or "▲ +" buttons**, it starts from the previous level.

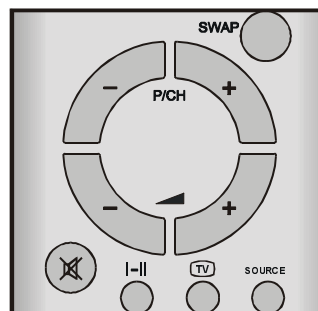

If **PIP layout** is selected, mute indicator is displayed at the **top centre** of the PIP window.

If **Split Screen** is selected, mute indicator is displayed at the upper left side of the active window.

AV Modes

By pressing the "SOURCE" button or via **source select** menu, you can switch your TV to AV modes (except being in Teletext). Pressing this button will consecutively switch the TV in one of the AV modes: **Scart 1**, **Scart 1 RGB**, **Scart 2**, **Scart 2 RGB**, **PC**, **DVI**, **FAV (Front AV Sockets)** and **SVideo**.

While watching VCR; **vcr** item in **options** menu should be set to **on**.

In order to quit the AV mode press the "TV", digit buttons, "**-P/CH**" or "**P/CH+**" buttons or press source until Tuner 1 is displayed.

Teletext

Teletext is an information system that displays text on your TV screen. Using the Teletext information system you can view a page of information on a subject that is available in the list of contents (index).

On screen display is not available in text mode.

Contrast, brightness or colour control is not available, but volume control is available in text mode.

To Operate Teletext

- Select a TV station on which Teletext is being transmitted.

- Press “” button. Usually the list of contents (index) is displayed on the screen.

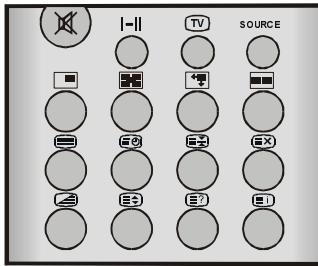

To Select A Page Of Teletext

- Press the appropriate digit buttons for the required Teletext page number.

The selected page number is displayed at the top left corner of the screen. The Teletext page counter searches until the selected page number is located, so that the desired page is displayed on the screen.

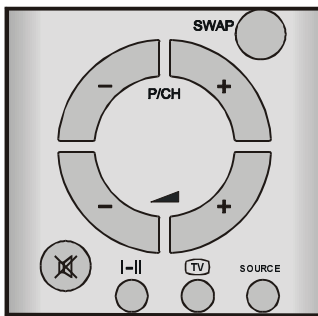



- Press “P/CH +” button to move the Teletext screen forward one page at a time.
- Press “- P/CH” button to move the Teletext screen backward one page at a time.



To Select Index Page

- To select the page number of the index, press “” button.



To Select Teletext With A TV Programme

- Press “” button. The text is now superimposed over the programme on the screen.
- Press “” button again to return to the Teletext page.

To Select Double Height Text



- Press “” button for the top half of the information page to be displayed in double height text.
- Press “” button again for the bottom half of the information page to be displayed in double height text.
- Press “” button once more for the full page of normal height text.

To Reveal “Concealed” Information

- Pressing “” button once will reveal answers on a quiz or games page.
- Pressing “” button again will conceal the revealed answers.



To Stop Automatic Page Change

The teletext page you have selected may contain more information than what is on the screen; the rest of the information will be displayed after a period of time.



- Press “” button to stop the automatic page change.
- Press “” button again to allow the next page to be displayed.

To Select A Subcode Page



Subcode pages are subsections of long Teletext pages that can only be displayed on the screen one section at a time.

- Select the required Teletext page.
- Press “” button.
- Select the required subcode page number by pressing four digit buttons (e.g. 0001).
- If the selected subcode page is not displayed in a short time, press “” button. TV programme will be displayed on the screen.
- Teletext page number will be displayed on the upper left corner of the screen when the selected page is found.
- Press “” button to display the selected Teletext page.



Split Screen

- During split screen, you can switch to the teletext mode of the TV programme on the left side of the screen only. Teletext is not available on the right side of the screen.
- Select the programme on the left side of the screen as the active window. Press the “” button. Teletext will be displayed on the screen. To exit teletext press “” or “” button.

To Exit Teletext

- Press “” or “” button. The screen will switch to TV mode.

To Display The Time

- While watching a TV programme with Teletext transmission press “” button. The current time information, captured from Teletext will be displayed on the screen.
- Press “” button again to remove the time from the screen.
- If the programme being watched does not have Teletext transmission, no information will be displayed.

Fastext

Your TV supports the 10 page Teletext system. When the page number of any of the 10 pages in memory is entered, the system will not search for the requested page; instead it will display the page automatically. If the requested page is not in memory, the system will search for the requested page number and save the 10 pages including the requested page into memory after finding it.

For Fastext

The subject-heading for the information may have a particular colour.

- Press the appropriate **RED**, **GREEN**, **YELLOW** or **BLUE** button in order to reach the relevant page quickly.

For TOP text

TOP text mode of operation will be activated automatically according to the transmission.

- If TOP text transmission is present, colour coded buttons will appear in the status row.
- If TOP text transmission is not present, status row will not appear.

The subject-heading for information may be located in colored box.

In Top mode the “-P/CH” or “P/CH+” commands will request the next or previous page respectively. If TOP text transmission is not available, in case of operation of these commands, wraparound occurs. For example page 100 appears to be one greater than page 199.

Connect Peripheral Equipment

There is a wide range of audio and video equipment that can be connected to your TV.

The following connection diagrams show you where the different equipment should be connected at the back or right side of the TV.

Via The Scart Socket

The TV has 2 Scart sockets. If you want to connect peripherals (e.g. video, decoder, etc.) which have Scart sockets, to the TV, use SCART 1 or SCART 2 inputs.

If an external device is connected via Scart sockets TV is switched to AV mode automatically. If the signal is RGB, select RGB in the source select menu to view picture. If the external device is connected to SCART 1, choose **Scart 1 RGB**. If the external device is connected to SCART 2, choose **Scart 2 RGB**.

Via Ant Input

If you want to connect to your TV, peripherals like video recorders or decoders, but the device you want to connect does not have Scart sockets, you should connect it to the ANT input of the TV.

If the VCR is connected via aerial input it is suggested to use the Programme 0.

TV And Video Recorder

- Connect the aerial cables.

Better picture quality can be obtained if you also [connect using a SCART cable](#).

Playback NTSC

To use this option you can;

- Connect NTSC VCR player to Euroconnector at the rear side of the TV.
- Connect NTSC VCR player to RCA Jacks at the right side of the TV.

Then, press "**SOURCE**" button to select proper source.

Copy Facility

Source selection for VCR recording.

- Select **options** menu.
- Select **scart 2 out** source using "▲" / "▼" buttons.
- Select **Scart 1** to copy the picture from tuner.
- Select **Scart 2** to copy the picture from FAV (Front AV) or SCART 2.

Search For And Store The Test Signal Of The Video Recorder

- Unplug the aerial cable from the aerial socket "**ANT**" of your video recorder.
- Switch on your TV and put the video recorder on the test signal. (See the [manual](#) for your video recorder.)
- Enter the **tv tuner** menu in **settings** menu. Enter the **programming** menu in **tv tuner** menu and select **manual search**.
- Search for the test signal of your video recorder in the same way as you searched for and stored the TV signals. See **programming** menu. Store the test signal under programme number 0.
- Replace the aerial cable in the aerial socket "**ANT**" of your video recorder once you have stored the test signal.

Camera And Camcorder

To Connect To FAV Input

Connect your camera or camcorder FAV input at the right side of the TV.

- Connect your equipment to the TV via **VIDEO** (yellow), **AUDIO R** (red) and **AUDIO L** (white) inputs. You should connect the jacks to the input in the same color.

To Connect To S-VHS Input

Connect your camera or camcorder S-VHS input at the right side of the TV.

- Connect your equipment to the TV via S-VHS input and audio inputs of FAV inputs by using S-VHS cables.

Connect a Decoder To a Video Recorder

Some video recorders have a special [Scart sockets](#) for decoder.

- Connect a [Scart cable](#) to the [Scart sockets](#) of your decoder and to the special [Scart sockets](#) of your video recorder. See also the [manual](#) of your video recorder.
- To connect your video recorder to the TV, see TV and Video Recorder section.

If you want to connect more equipment to your TV, consult your dealer.

Connecting Headphones

Use the stereo headphone socket [on](#) the right side of the TV, to connect headphones.

Aerial Connections

Outdoor Antenna Connections

VHF antenna
Method 1

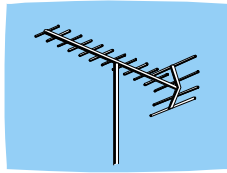

Round 75 ohm coaxial cable

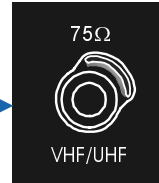

Rear of TV

VHF/UHF antenna
Method 2

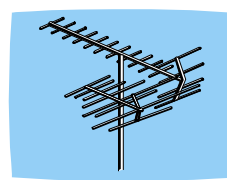

Flat 300-ohm twin lead cable

Round 75-ohm coaxial cable

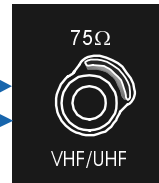

Rear of TV

Connect Peripheral Equipment

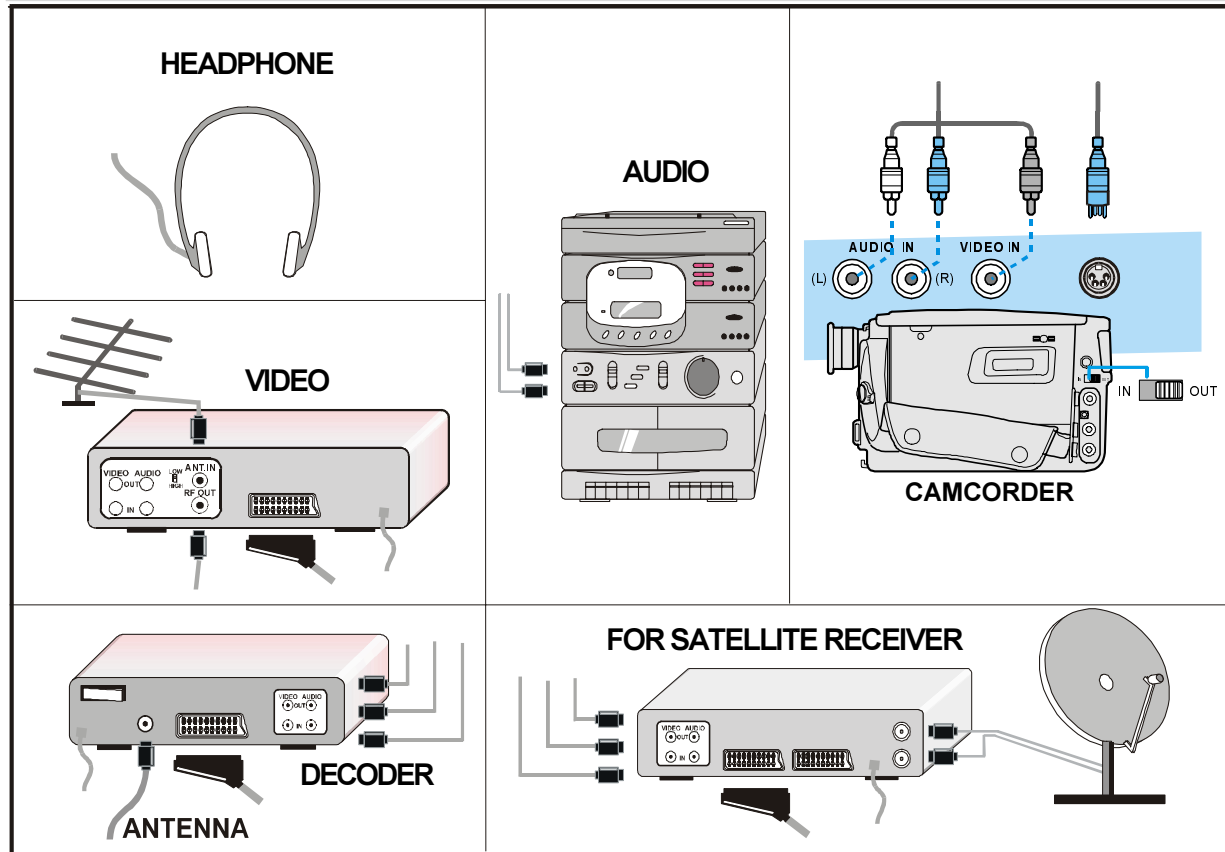

Tips

Care Of The Screen

Clean the screen with a slightly damp, soft cloth. Do not use abrasive solvents as they may damage the TV screen coating layer.

Poor Picture

Have you selected the correct TV system? Is your TV set or house aerial located too close to the loudspeakers, non-earthed audio equipment or neon lights, etc.?

Mountains or high buildings can cause double pictures or ghost images. Sometimes you can improve the picture quality by changing the direction of the aerial.

The picture quality may degrade when two peripherals are connected to the TV at the same time. In such a case, disconnect one of the peripherals.

No Picture

Is the aerial connected properly? Are the plugs connected tightly to the aerial socket? Is the aerial cable damaged? Are suitable plugs used to connect the aerial? If you are in doubt, consult your dealer.

No Picture means that your TV is not receiving any transmission. Have you pressed the correct buttons on the remote control? Try once more.

Sound

You can not hear any sound. Did you perhaps interrupt the sound, pressing "~~X~~" button? Are external speakers connected to the TV?

Sound is coming from only one of the speakers. Is the balance set to one direction extreme? See **audio** menu.

Remote Control

Your TV no longer responds to the remote control. Press the "**TV**" button on the remote control once more. Perhaps the batteries are exhausted. If so you can still use the local buttons on the top of the TV.

Have you selected the wrong menu? Press "**TV**" button to return to TV mode or press "**M**" button to return to the previous menu.

No solution:

Switch your TV set off and on. If this does not work, [contact the Goodmans product information helpline on 0870 873 0080](#); never attempt to repair it yourself.

Specifications

TV BROADCASTING

PAL I/I'

RECEIVING CHANNELS

VHF (BAND I/III)

UHF (BAND U)

HYPERBAND

CABLE TV (S1-S20/ S21-S41)

NUMBER OF PRESET CHANNELS 100

CHANNEL INDICATOR

On Screen Display

RF AERIAL INPUT

75 Ohm (unbalanced)

OPERATING VOLTAGE

230-240V AC, 50 Hz.

AUDIO

Nicam Stereo

AUDIO OUTPUT POWER (W_{RMS}) (%10 THD)

2 x 8

POWER CONSUMPTION (W) (max.)

148 W

< 3 W (Stand-by)

PANEL

16:9 display, 29,53" Screen Size

DIMENSIONS (mm)

DIMENSIONS (mm)				
D	L	H	Weight (kg)	
260	847	522	14.8	With foot
102	847	490	13	Without foot

Important Instruction

For your own safety read following instruction carefully before attempting to connect this unit to the mains supply.

MAINS (AC) OPERATION

The wires in this mains lead are coloured in accordance with the following code :

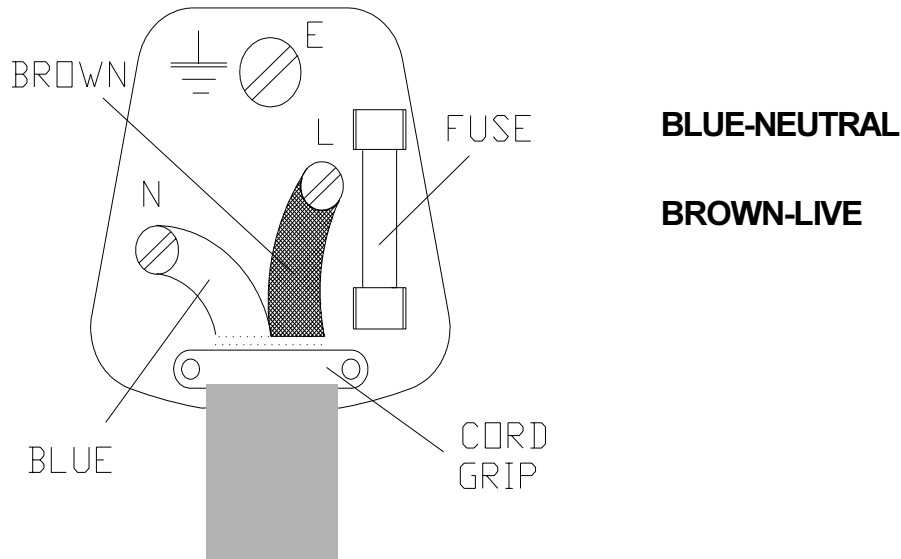

IMPORTANT

As the colours of the wires in the mains lead of this appliance may not correspond with the coloured markings identifying the terminals in your plug, proceed as follows:

The wire which is coloured blue must be connected to the terminal which is marked with the letter N or coloured black.

The wire which is coloured brown must be connected to the terminal which is marked with the letter L or coloured red.

No connection is to be made to the earth terminal of the plug.

If a 13 Amp (BS 1363) Plug is used a 5 Amp Fuse must be fitted, or if any other type of Plug is used a 5 Amp Fuse must be fitted, either in the Plug or Adaptor, or on the Distribution Board.

CAUTION

TO PREVENT ELECTRIC SHOCK DISCONNECT FROM THE MAINS BEFORE REMOVING COVER. NO USER SERVICEABLE PARTS INSIDE. REFER SERVICING TO QUALIFIED SERVICE PERSONNEL.

SAFETY PRECAUTION

THIS EQUIPMENT MUST BE DISCONNECTED FROM THE MAINS WHEN NOT IN USE. DO NOT ALLOW THIS UNIT TO BE EXPOSED TO RAIN OR MOISTURE.