

Checking Accessories

When unpacking the projector and accessories from their box, check that the following items are included.

If any items are missing, contact your vendor or an Epson Service Center.

- Projector main unit
- Lens cover with cord

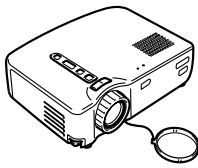

- Remote control

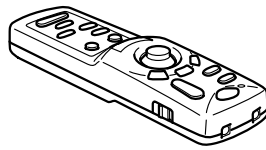

- Two remote control batteries (AA manganese, R6)

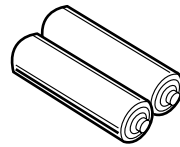

- Power cord



- Computer cable

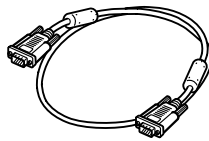

- A/V cable (red/white/yellow)

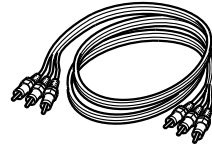

- USB mouse cable

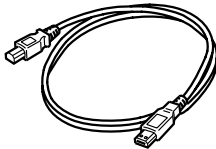

- PS/2 mouse cable



- Instruction Manual (this manual)

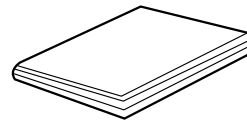

- Soft case

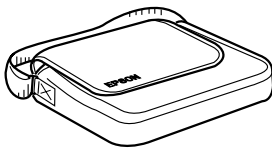

Some references to "the unit" or "the projector" in this Manual also refer to accessories supplied with the projector or components sold separately from the projector itself.



In This Manual

Getting Started

Safety precautions and component names and functions

Setup

Special notes on setup, setup instructions, and screen size and projection distance details

Projecting Images

Connecting with different devices and projecting and adjusting images

What You Can Do

Functions to get the most out of your projector

Menu Functions (Remote Control Only)

Basic menu functions and settings

Troubleshooting

Troubleshooting projection failure, bad projection, and other problems

Maintenance

Performing lamp replacement and other routine maintenance and care

General Notes

Optional parts, shipping instructions, glossary, index, specifications and international warranty

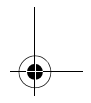
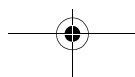
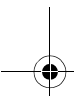
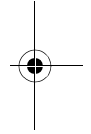
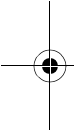



Contents

In This Manual	1
Contents	2
Features.....	4
1. Getting Started	
1.1 Safety Precautions	8
1.2 Component Names and Functions.....	12
1.3 Remote Control	15
2. Setup	
2.1 Special Notes on Setup.....	18
2.2 Setup Instructions.....	19
2.3 Screen Size and Projection Distance Details.....	20
3. Projecting Images	
3.1 Connecting to a Computer	22
3.2 Connecting to an A/V Device	25
3.3 Providing Sound Through an External Audio Device	27
3.4 Projecting Images.....	28
3.5 Adjusting Images.....	32
3.6 Ending After the Projection.....	35
4. What You Can Do	
4.1 Using the Wireless Mouse.....	38
4.2 Enlarging an Image	40
4.3 Adjusting Image Size.....	41
4.4 Adding Image Effects	42
4.5 Freezing and Deleting Images	43
4.6 Displaying Help Screens	44

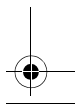
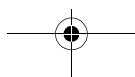
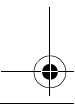
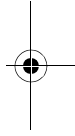
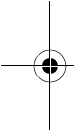



5. Menu Functions (Remote Control Only)

5.1 Learning Basic Operations	46
5.2 Video Menu	47
5.3 Audio Menu	49
5.4 Effect Menu	50
5.5 Setting Menu	51
5.6 Advanced Menu.....	53
5.7 About Menu	54
5.8 Reset All Menu	55

6. Troubleshooting

6.1 Possible Failures	58
6.2 When Indicators Do Not Help	60

7. Maintenance

7.1 Projector Cleaning, Lens Replacement, Air Intake Vent Cleaning.....	66
7.2 Lamp Replacement	68

8. General Notes

8.1 Optional Parts.....	72
8.2 Shipping Instructions	73
8.3 Glossary	74
8.4 Index.....	75
8.5 Specifications	77
8.6 External Dimensions.....	78
8.7 International Warranty System	79

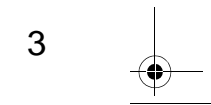
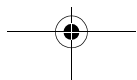
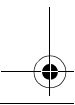
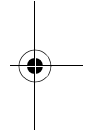
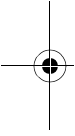

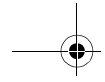

Features

Compact and Lightweight

The compact, lightweight design of your projector (6.6 liters and roughly 3.1 kilograms (6.83 pounds)) allows easy carrying.

Clear, Sharp Images

Though compact, your projector provides clear, sharp presentations even in well-illuminated areas.

Global Video Signal Compatibility

Your unit projects virtually all of the video signal formats used world-wide, including NTSC, NTSC4.43, PAL, M-PAL, N-PAL, PAL60, and SECAM.

Improved Video Image Clarity

Projection of distinct video images from composite video and S-video input is possible.

"Keystone" Correction Function (see pages 33 and 51)

This built-in function allows easy correction of trapezoidal distortion caused by projection angle.

Wireless Mouse Remote Control for Computer Mouse Operations (see page 38)

The remote control allows wireless operation of various projector functions, including cursor/stamp, horizontal bar display, and image enlargement and reduction.

Presentation Effects Function (Remote control Effect button, see page 42)

Use of the remote control Effect button creates effective presentations.

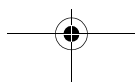
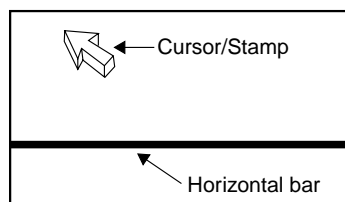



E-Zoom Function (Remote control E-Zoom button, see page 40)
Enlarges an image (from standard to 4x size vertically and horizontally).

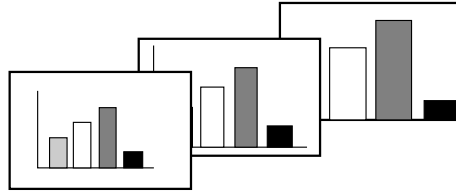

Automatic image sizing with Wide/Tele button (see page 41)
Allows image enlargement and reduction.

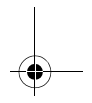
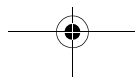
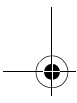
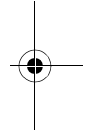
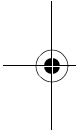
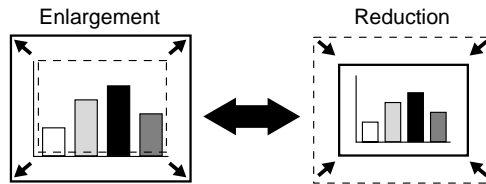

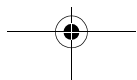
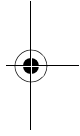
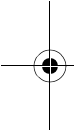
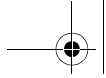



1 Getting Started

1.1	Safety Precautions	8
1.2	Component Names and Functions	12
1.3	Remote Control	15

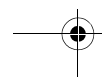
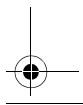
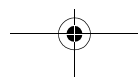
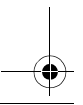
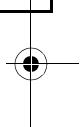
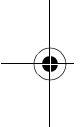



1.1 Safety Precautions

To ensure safe and proper use of your projector, read these safety precautions completely.

⚠ Warning: Improper operation that disregards this symbol may result in serious injury or death.

⚠ Caution: Improper operation that disregards this symbol may result in injury or damage to objects.

⚠ Warning:

If any of the following malfunctions occur, immediately shut off and unplug the projector and consult your vendor or an Epson Service Center.

- Occurrence of smoking, odour, or abnormal noise
- Failure of projection or sound
- Penetration of unit by water or a foreign object
- Dropping of unit or other damage to the cabinet

Continued use may cause fire or electric shock.

Repairing the unit yourself is hazardous and should never be attempted.

Only trained service personnel should open the projector cabinet, and the unit should never be disassembled or modified.

The cabinet contains many high voltage components which may cause fire, electric shock, or other accidents.

Use only a voltage indicated on the unit itself.

Use of a non-designated voltage may cause fire or electric shock.

Check that the power cord specifications are correct.

A power cord which matches the specifications in the country of purchase is included with the projector. If the projector is used in a different country from the country of purchase, check the power supply voltage and the shape of the wall outlet in the destination country beforehand, and make sure that you obtain a proper power cord which matches the specifications for that country.

Do not use a damaged power cord.

Fire or electric shock may result.

Treat the power cord as follows.

- Do not modify the power cord.
- Do not place heavy objects on the power cord.
- Do not bend, twist, or pull the power cord severely.
- Do not run the power cord near heating equipment.

If the power cord becomes damaged, consult your vendor or an Epson Service Center.



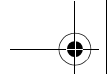

When the projector is on, never look into the lens.

The intense light may damage your vision. Where small children are present, take particular care.

Handle the power cord plug and unit connector with care.

Improper handling may cause fire or electric shock.

Treat the power cord plug and connector as follows.

- Do not overload wiring.
- Do not insert a dusty or dirty plug or connector in an outlet.
- Insert firmly and completely.
- Do not pull out with wet hands.
- Do not use the cable to pull out the plug or connector. Always hold the plug or connector itself.

The projector cabinet contains lenses, a lamp, and many other glass components.

When handling any broken components, use care to avoid injury from fragments, and consult your vendor or an Epson Service Center for repair.

Do not place breakable objects, containers of liquid, medicines, or similar items on the unit.

Spillage or penetration may cause fire or electric shock.

Do not insert or drop metal, flammable, or other foreign objects into the intake or exhaust vents of the unit.

Fire or electric shock may result.

Do not leave the unit or the remote control containing batteries in a closed automobile, area of direct sunlight, air conditioner or heater outlet, or other high temperature location.

Heat may deform the unit or remote control or cause internal components to malfunction, leading to fire.

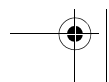
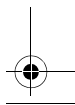
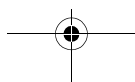
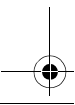
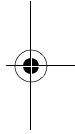
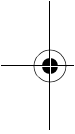



⚠ Caution:

Do not sit, stand, or place heavy objects on the unit.
Tipping or breakage may result and cause injury.

Do not place the unit on an unsteady base, inclined location, or other unstable area.
The unit may fall or tip and cause injury.

Set up and store the unit out of reach of children.
The unit may fall or tip and cause injury.

Do not place the unit in a humid or dirty location, near a food preparation area or humidifier, or in the path of smoke or steam.
Fire or electric shock may result.

Do not block the ventilation slots of the unit. Blockage will cause internal heat build-up and may result in fire. Do not set up the unit in the following locations.

- In closets, bookshelves, or other cramped locations with poor ventilation
 - On carpets, bedding, or blankets.
 - Do not cover the unit with blankets, curtains, tablecloths, or other cloths.
- If set up near walls, allow at least 20cm (7.87inches) from all walls.

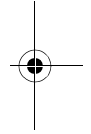
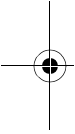

For safety, always unplug the unit when it will not be used for extended periods.
Fire may result.

When moving the unit, switch off and unplug the unit and make sure that all cables are disconnected.
Fire or electric shock may result.

Never remove the lamp immediately after use. After shutting off the projector, allow an hour for complete cooling.
Heat may cause burns or injury.

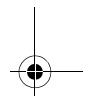
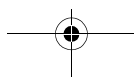
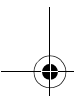



Improper use of batteries may cause battery damage and leakage of liquid, resulting in fire, injury, or corrosion of the unit. Observe the following precautions to ensure safety.

- Do not mix batteries of different type or age.
- Use only batteries specified in the Instruction Manual.
- In case of battery leakage, wipe up the leakage with a cloth or other item and insert fresh batteries.
- Exchange expired batteries promptly.
- Remove the batteries during extended periods of non-use.
- Do not heat the batteries or throw them into a fire or liquid.
- Insert the batteries with correct polarity (+, -).
- If any leakage contacts your hands or other areas, wash promptly with water. Dispose of batteries in accordance with local collection procedures.

When maintaining the unit, disconnect the power cord at both ends.

Electric shock may result.

Cautions For Use

- **Environments outside the temperature range for use (5°C to 35°C) may cause irregular display, strain of the fan, and malfunction.**
- **Environments outside the temperature range for storage (-10°C to 60°C) may cause malfunction and deformation of the cabinet. Take particular care not to leave the projector for extended periods in locations exposed to direct sunlight.**
- **Do not attempt projection with the lens cover in place. Heat may deform the lens cover.**
- **The LCD panel is a product of extremely high-precision technology and contains more than 99.99% functional pixels, but you should bear in mind that less than 0.01% of the pixels are non-functioning or light improperly.**

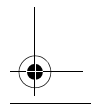
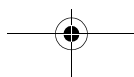
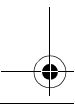
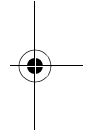
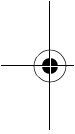



1.2 Component Names and Functions

Projector Unit

[Front]

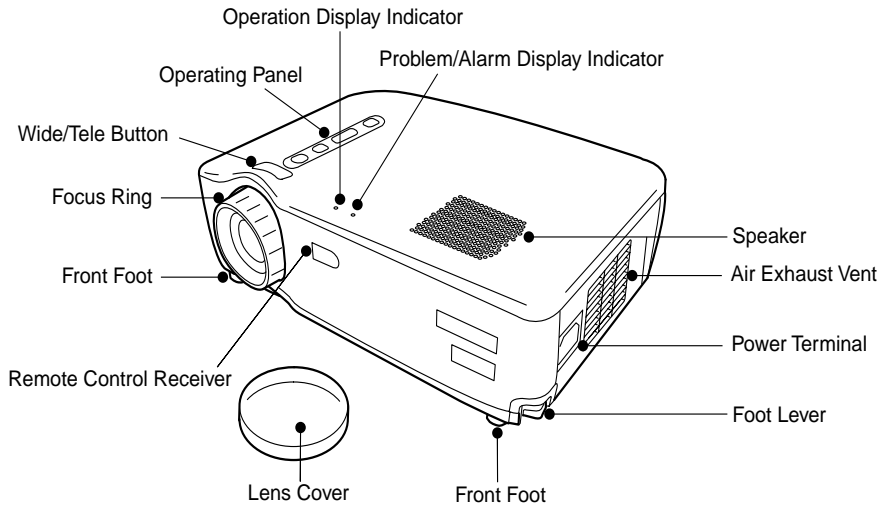

[Side]

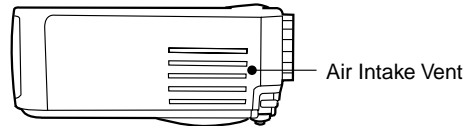

[Rear]

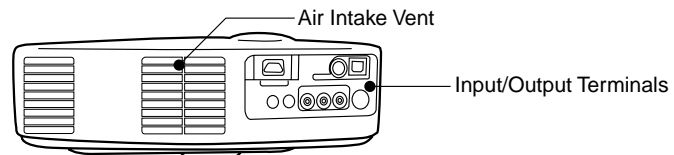

[Bottom]

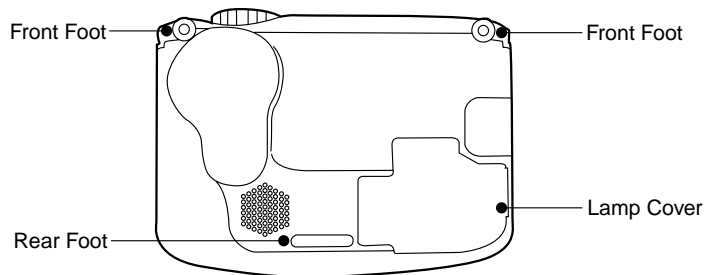

[Wide/Tele Button (see page 41)]

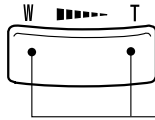

Press the right side of the button (Tele) to reduce the image.
Press the left side of the button (Wide) to enlarge the image.

[Operating Panel]

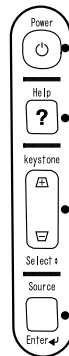

Power Button (see pages 29, 35)

Switches power on and off.
*Press twice to turn the power off.

Help Button (See page 44)

Displays help screen.

Keystone (Select) Button (see pages 33, 51)

Adjust when screen is distorted trapezoidally.

Source (Enter) Button (See page 30)

Toggles the video source between Computer, S-Video, and Composite video.

[Input Terminals]

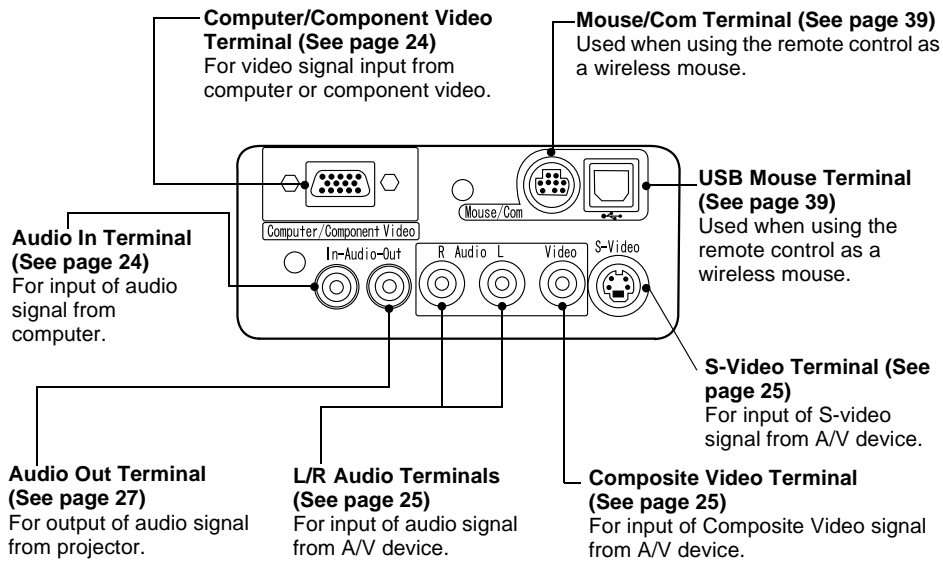

Remote Control

[Front]

Freeze Button (See page 43)

Temporarily stops a moving picture.
To release the freeze, press the button again.

A/V Mute Button (See page 43)

Temporarily eliminates picture and sound.
To release muting, press the button again or adjust the volume.

Effect Button (See page 42)

Executes an assigned effect function.

Esc Button

Cancels an executing function and serves as the right mouse button.

Menu Button (See page 46)

Displays or cancels menus.

Auto Button (See page 34)

Optimizes computer video.

Volume Button (See page 34)

Adjusts volume.

Indicator

Lights during signal output from remote control.

Power Button (see page 29, 35)

Switches projector power on and off.
*Press twice to turn the power off.

R/C On Off Button (see pages 29, 36)

Switches remote control power on and off.

E-Zoom Button (See page 40)

Executes the E-Zoom function.

Enter Button

Used for scrolling, menu item selection, and as the left mouse button.

Help Button (See page 44)

Provides topic-specific explanation for addressing problems.
Use this button when problems occur.

Computer, S-Video, Video Button (See page 30)

Switches to the selected video source.

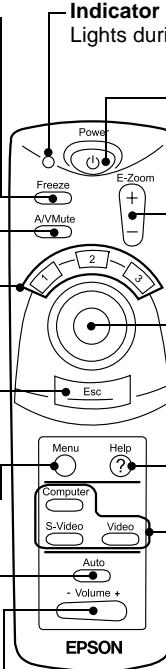

[Back]

Battery Cover

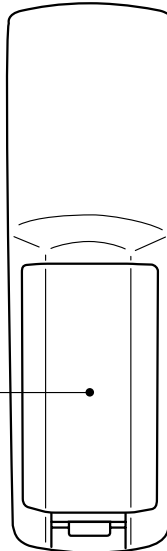



1.3 Remote Control

Operating Range

The remote control may not operate beyond certain distances and angles from the receiver on the projector. Observe the following conditions during use.

[Operating Distance : Approximately 10m (393.70inches)]

[Operating Area:]

Horizontally

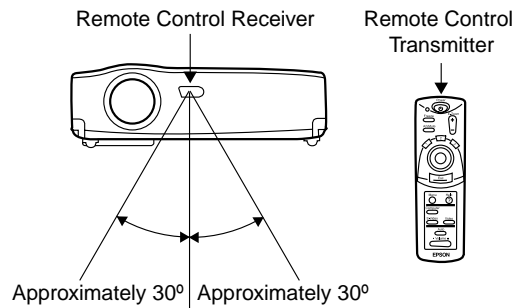

Vertically

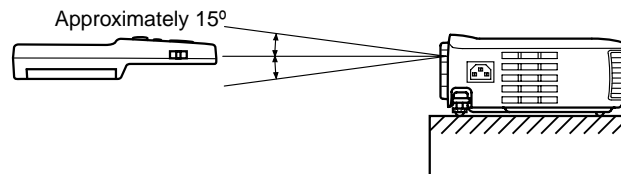

Point:

- The remote control R/C On Off switch must be switched to "On" to use the remote control.
- Point the remote control towards the remote control receiver on the projector unit.
- Certain screens may shorten the operating distance (approximately 10m (393.70inches)) of the remote control when the control is pointed towards the screen to reflect its signal during use.
- Situate the remote control receiver out of direct sunlight, fluorescent light, and similar light sources.
These may cause the remote control to malfunction.
- If the remote control malfunctions or stops operating, the batteries may need changing.
Replace the batteries with a fresh set.

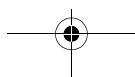



Inserting Batteries in the Remote Control

This section describes how to insert batteries in your remote control.

1. Remove the battery cover.
Slide the catch of the battery cover in the direction shown by the arrow.

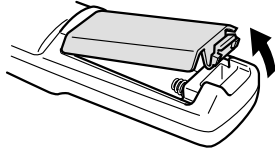

Caution:

Be sure to use fresh batteries of the same type as the old.

2. Insert batteries.
Be sure to match the polarity to that indicated on the remote control.

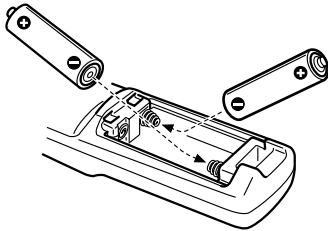

Point:

- Battery type
(2) AA manganese cells (R6)
- Use of 30 minutes per day will require a change of batteries approximately every 3 months.

3. Replace the battery cover.
Press the battery cover into the remote control until it clicks firmly into place.

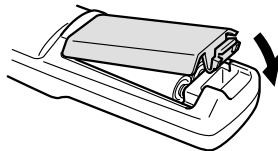



2 Setup

- 2.1 Special Notes on Setup..... 18
- 2.2 Setup Instructions..... 19
- 2.3 Screen Size and Projection Distance Details..... 20

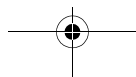

2.1 Special Notes on Setup

The best picture is obtained when the projector and screen are set up facing each other directly, as shown below.
Set your projector and screen up this way.

[View from right or left]

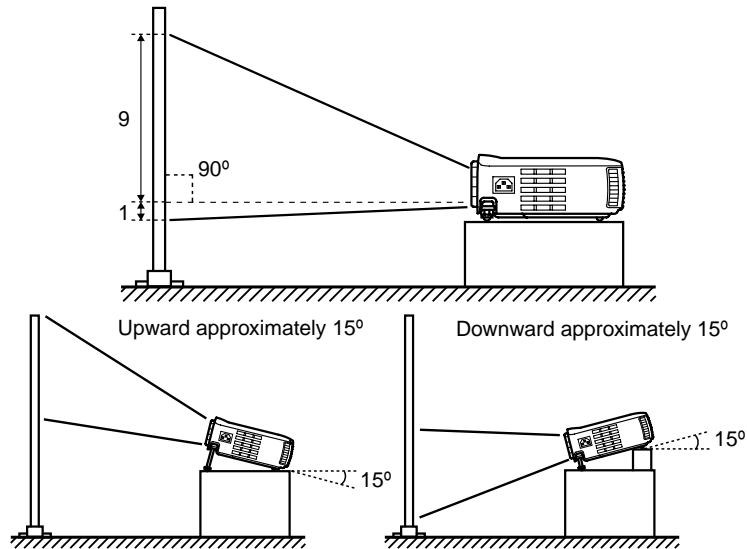

Keystone correction allows correction of trapezoidal distortion (see pages 33, 51).

[View from above or below]

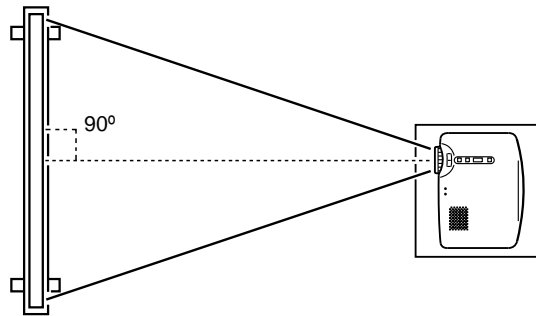

Caution:

- Do not block the air exhaust vent on the side of the projector or the air intake vents on the right side and rear of the projector.
- Do not place the unit in direct contact with air conditioner, heater, or other ventilation currents.
- When setting up the projector near walls, allow at least 20cm (7.87inches) from all walls.



2.2 Setup Instructions

Your projector allows projection in the following two ways. Set up the projector as your location requires.

[Viewing from the front]

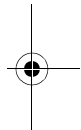
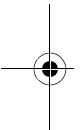
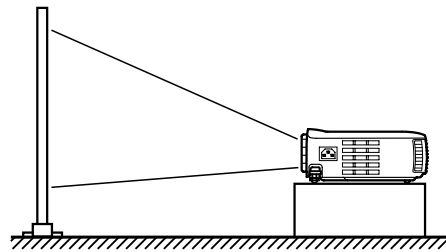
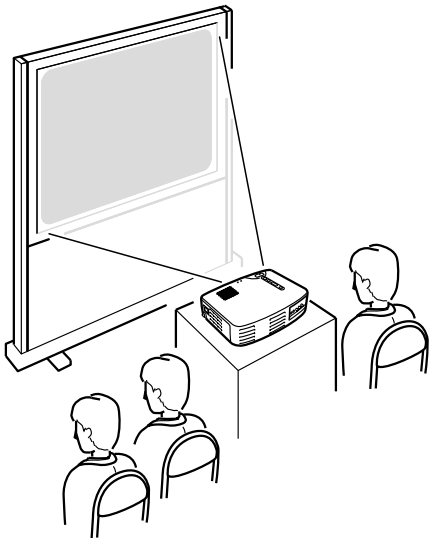

[Projection on a semi-transparent screen and viewing from the rear]

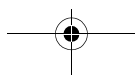
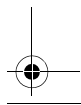
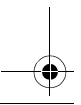
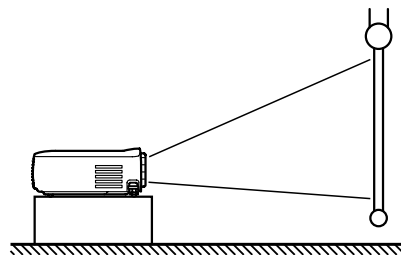
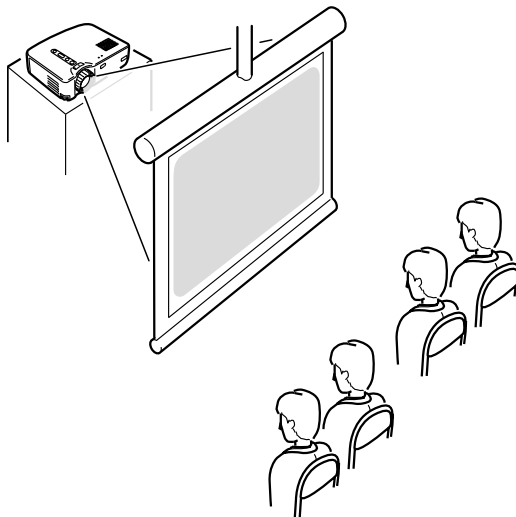



2.3 Screen Size and Projection Distance Details

Select a distance from lens to screen that provides your desired screen size. The recommended distance is 1.0 m (39.37inches)—13.1 m (515.75inches). Refer to the following table for setup.

Screen size (cm)	Approximate projection distance* (m (inch))
Size 300" (610x460)	11.0—13.1 (433.07—515.75)
Size 200" (410x300)	7.3—8.7 (287.4—342.52)
Size 150" (305x228)	5.5—6.5 (216.54—255.91)
Size 120" (244x183)	4.4—5.3 (173.23—208.66)
Size 100" (200x150)	3.7—4.3 (145.67—169.29)
Size 80" (160x120)	2.9—3.4 (114.17—133.86)
Size 60" (120x90)	2.2—2.6 (86.61—102.36)
Size 40" (81x61)	1.5—1.7 (59.06—66.93)
Size 30" (61x46)	1.1—1.2 (43.31—47.24)
Size 28" (57x43)	1.0—1.1 (39.37—43.31)

* Use the "approximate projection distance" as a guide to setup. Projection conditions and other factors can affect results.

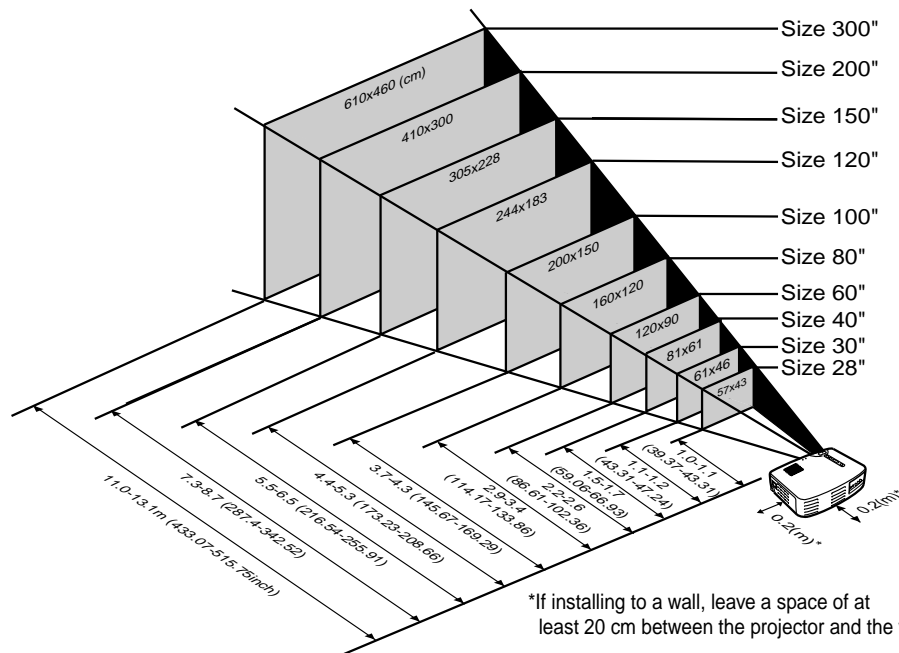

Point:
A keystone correction will reduce screen size.

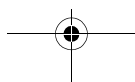



3 Projecting Images

3.1	Connecting to a Computer	22
3.2	Connecting to an A/V Device	25
3.3	Providing Sound Through an External Audio Device	27
3.4	Projecting Images.....	28
3.5	Adjusting Images	32
3.6	Ending After the Projection	35

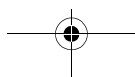



3.1 Connecting to a Computer

Computers which can be connected

Some computer models may not allow connection, and others may allow connection but not projection.

Make sure that the specifications of the computer you are using for connection meet the following two requirements.

[The computer must have a video signal output port]

Make sure that the computer has a port that outputs a video signal.

A port that outputs a video signal is called an "RGB port", "monitor port", or "video port" or the like.

Consult the section describing "connection to an external monitor" or the like in the instruction manual for the computer that you are using, and make sure that the computer has a video signal output port.

Computers with an integrated monitor and other components as well as notebook personal computers may require separate purchase of an external output port.

In other cases, an external output port cannot be attached.

[The resolution and frequency of the computer must be within the range of specifications shown on the following page]

The resolution and frequency of the video signal output by your computer must be compatible with your projector in order to allow projection (some computers allow partial projection, but clear projection cannot be obtained).

Check the resolution and frequency of the video signal in the instruction manual of the computer you are using for projection.

Compatible Mode Chart for Connectable Computers

If the resolution and frequency of the video signals which are output from the computer do not correspond to any of the values in the table below, those video signals cannot be projected. (In some cases it may be possible to project such signals, but they will not produce clear images.)

Check the instruction manual for the computer for details on the resolution and frequency of the video signals.

Furthermore, some computers may let you change the output resolution. If this is the case, change the resolution to a value in the table below.

Signal (Resolution) (dots)	Signal	Refresh rate (Hz)	Frequency used for resized displays (when resizing is on) (dots)		
			EMP-70	EMP-50	
PC (RGB) compatible modes	640 x 350	VGAEGA	60	1024 x 560	800 x 437
	640 x 400	VGACGA	60	1024 x 640	800 x 500
	720 x 400	VGA Text	70	1024 x 568	800 x 444
	720 x 350	VGA Text	70	1024 x 497	800 x 388
	640 x 480	VESA	60/72/75/85	1024 x 768	800 x 600
	800 x 600	SVGA	56/60/72/75/85	1024 x 768	800 x 600
	1024 x 768	XGA	43i/60/70/75/85	1024 x 768	800 x 600
	1152 x 864	SXGA1	70/75/85	1024 x 768	-
	1280 x 960	SXGA2	60/75/85	1024 x 768	-
	1280 x 1024	SXGA3	43i/60/75/85	960 x 768	-
	640 x 480	MAC13	66	1024 x 768	800 x 600
	832 x 624	MAC16	75	1024 x 768	800 x 600
	1024 x 768	MAC19	60/75	1024 x 768	800 x 600
	1152 x 870	MAC21	75	1024 x 768	800 x 600
PC (YUV) compatible modes	-	HDTV525I	50/60	1024 x 768	800 x 600
	-	HDTV525P	50/60	1024 x 768	800 x 600
	1280 x 720	HDTV750P	50/60	1024 x 576	800 x 450
	1920 x 1080	HDTV1125I	50/60	1024 x 576	800 x 450
Video compatible modes	-	NTSC	60	1024 x 768	800 x 600
	-	PAL	50	1024 x 768	800 x 600
	-	SECAM	50	1024 x 768	800 x 600

Connecting to a Computer

- Before connecting, switch off power to the projector and computer.
- Check that cable and terminal interfaces match each other.

[Projecting Computer Video]

You can make presentations on a large screen by projecting computer video from your projector.

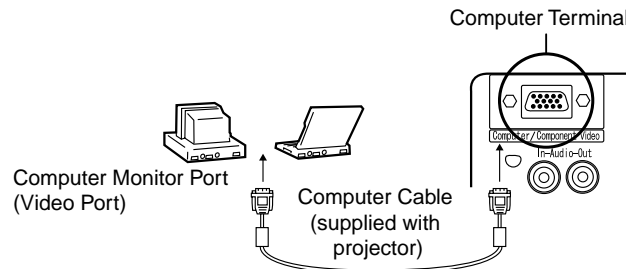

- * If your computer port style is not a mini D-Sub 15-pin interface, use a connection adapter that provides this interface.

When connecting to a Macintosh, you may need an optional Mac desktop adapter.

Point:

- When using the projector, do not bundle power cords and computer cables together.
- Some computer models may require a connection adapter during connection. Consult your computer instruction manual or the computer vendor.

[Outputting Computer Audio From Your Projector]

You can output computer audio from a built-in speaker in your projector. Your projector allows output at a maximum 1W.

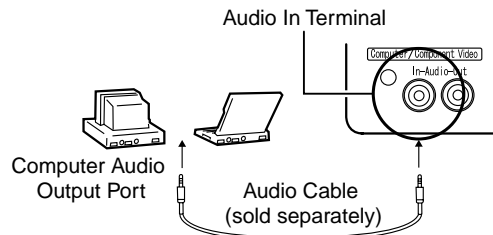

Point:

- When computer video has been selected or when audio input is specified on the computer by menu, your projector outputs an audio signal from the computer.
- Purchase an audio cable that matches the terminal style of your computer's output terminal and the projector's Audio In terminal (stereo mini jack).

3.2 Connecting to an A/V Device

[Inputting a Composite Video Signal]

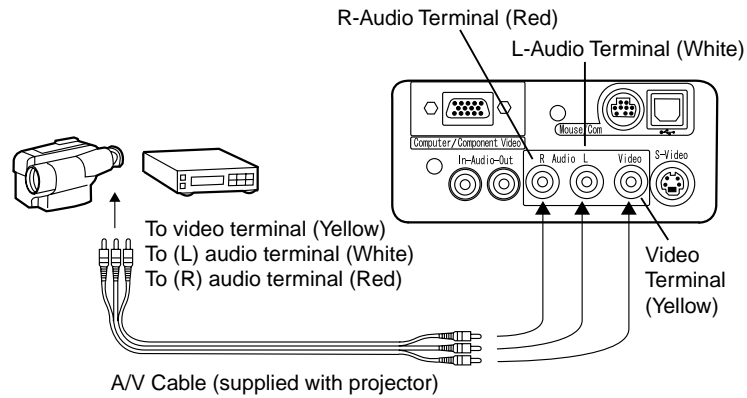

[Inputting an S-Video Signal]

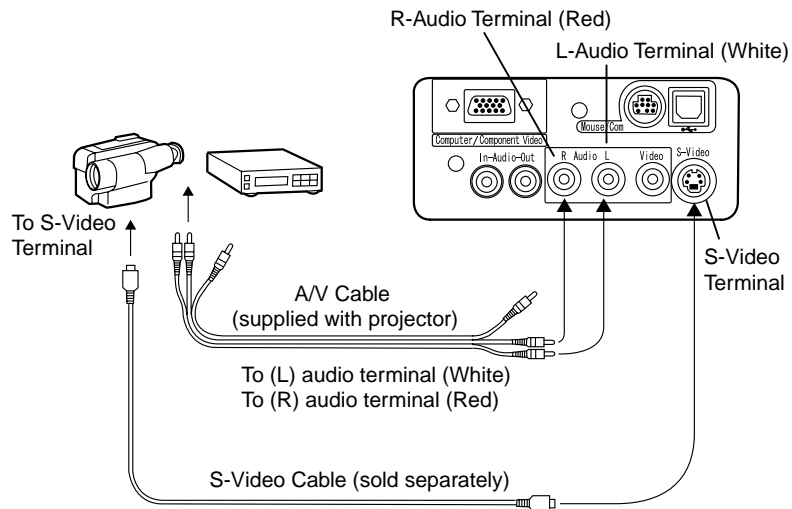

[Inputting a Component Video Image Signal]

- If using a component video cable

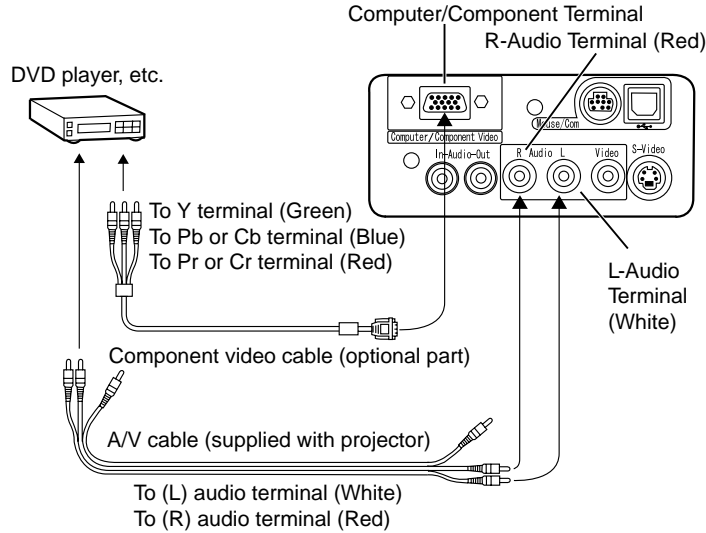

- If using a D terminal cable

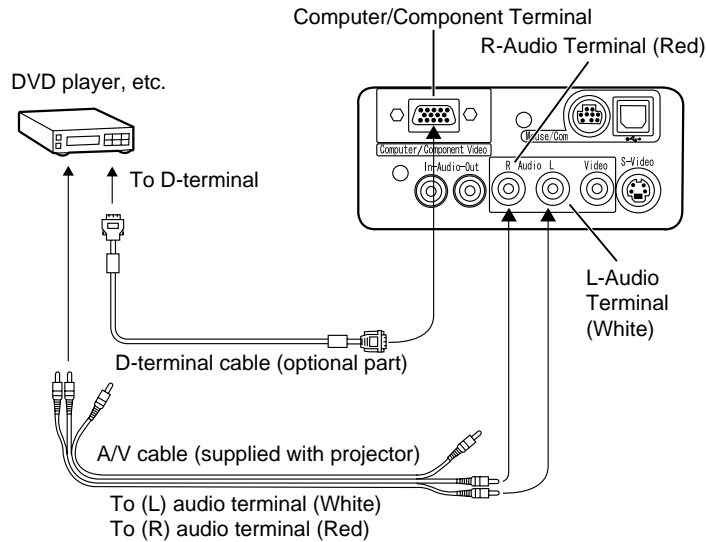

Point:

- When projecting a component video image, select "YCbCr" or "YPbPr" in the Video > Input Signal menu.
Select "YCbCr" if using a DVD player, and select "YPbPr" if using a HDTV video source.
- To change the aspect ratio of the projected image between 4:3 and 16:9, select Video > Aspect Ratio menu.

3.3 Providing Sound Through an External Audio Device

Connecting the Audio Out terminal of your projector to a PA system, active speaker system, or other speakers with built-in amplifiers provides powerful, pleasing sound.

Use a separately sold audio connection cable (pin ring) connecting to a 3.5mm (0.14inches) stereo mini-jack plug.

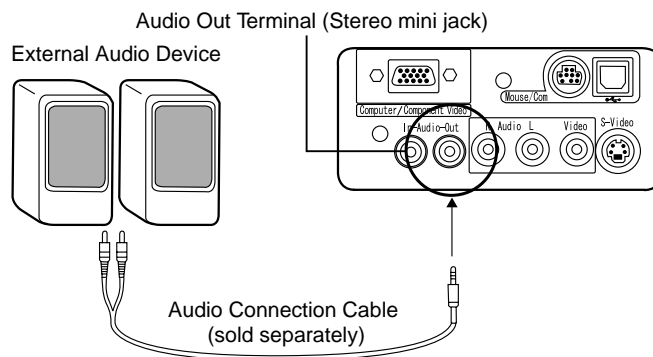

Point:

- Insertion of pin plugs into the audio output terminals provides automatic external output of audio. Audio will no longer be output from the projector speaker.
- Though the projector outputs audio for projected video images, in the case of A/V devices, the audio output corresponds to the audio devices connected to the L/R audio terminals.
- Before purchasing an audio connection cable, thoroughly check the connection interface style of the external audio devices you are connecting.

3.4 Projecting Images

Here we begin projecting images from an A/V device.

Preparation

Warning:

- *Never look into the lens when the projector is switched on. The intense light can damage your vision.*
- *Use only the power cord supplied. Use of other cables may cause fire or electric shock.*

Caution:

- *Do not attempt projection with the lens cover in place. Heat may deform the lens cover.*

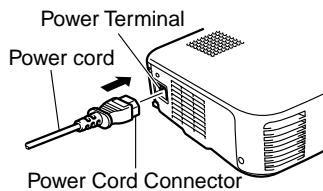

1. Check that the projector and computer or A/V device are connected.
2. Remove the lens cover.
3. Attach the power cord (supplied with projector) to the projector. Align the power cord connector with the power terminal on the projector and insert the connector firmly and completely into the terminal.

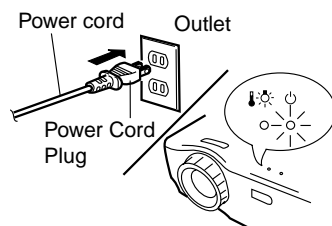

4. Insert the plug end of the power cord in an outlet. The operation display indicator will light with an orange color.

Point:

Buttons cannot be operated while the operation display indicator is flashing orange.

Projection

When preparations are complete, you are ready for projection.

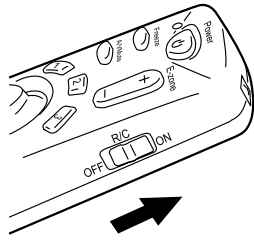

1. To use the remote control, turn the remote control R/C On Off switch to "On".

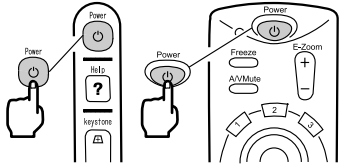

2. Press the Power button to switch power on. The operation display indicator begins to flash green, and projection begins.



"No-Signal" is displayed. Depending on your settings, there may be no display. (See page 51)

After approximately 30 seconds, the operation display indicator changes from flashing green to steady green.

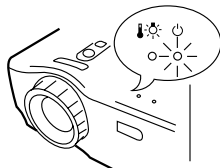

The operation display indicator lights green.

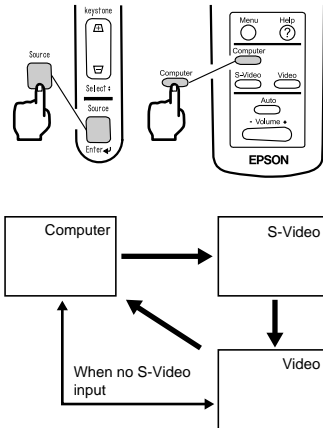

3. Press the Source button to select the video source you wish to project.

Each time the Source button is pressed, the video source cycles between Computer, S-Video, and Video.

If there is no input at the S-Video terminal, the Source button switches the video source from Computer to Video.

Point:

- When you use the remote control to select the video source you wish to project, you can switch the source by pressing any of the Computer, S-Video, or Video buttons.
- If projecting a component video picture, change the setting to Computer.

4. Switch on power to the computer or A/V device to begin projection.

The "No-Signal" display disappears, and a video signal from the computer or A/V device is projected.

Point:

- If the "No-Signal" display remains, check the connections again.
- If the same static image is projected for some time, the video projection may contain an afterimage.



[Settings for notebook and integrated LCD computers (when connected)]

When a notebook or integrated LCD computer is connected to the projector, some computers require key commands or settings to change the output destination of a video signal.

Press "Fn" and "F0" simultaneously to change the setting.

For details, consult the instruction manual of the computer you are using.

Manufacturer	Output Switching Example
NEC	"Fn"+"F3"
Panasonic	"Fn"+"F3"
Toshiba	"Fn"+"F5"
IBM	"Fn"+"F7"
SONY	"Fn"+"F7"
Fujitsu	"Fn"+"F10"
Macintosh	After restarting, the monitoring and sound on the control panel are set to mirror the computer.

Point:

Some computers may not be able to have images displayed on the computer screen at the same time as they are being projected. In such cases, use only external output.

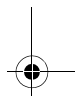
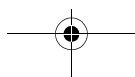
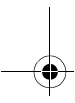
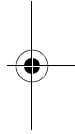
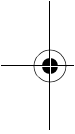



3.5 Adjusting Images

This section describes how to obtain the best video performance.
See "2. Setup" for details on setting-up position and projection size.

Adjusting the Image Projection Angle

Adjust the projection angle of the projector.
Adjust the projector to face the screen as directly as possible.

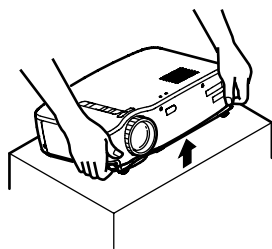

1. Lift the projector to your desired angle of projection.

Foot Levers

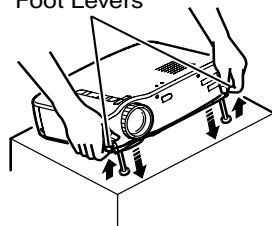

2. Use your fingers to pull up the foot levers. Front feet emerge.

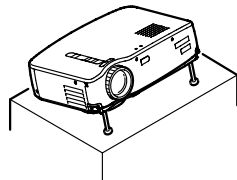

3. Release the foot levers.

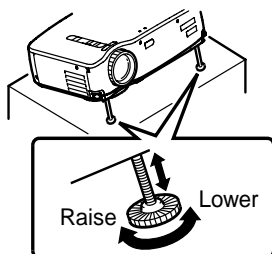

4. Make fine adjustments to the height.
Turn the lower portion of the front feet to make fine adjustments to height.

Point:

Setting back the front feet (see page 36)

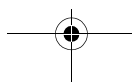



Adjusting the Focus

This section describes how to adjust the video focus.

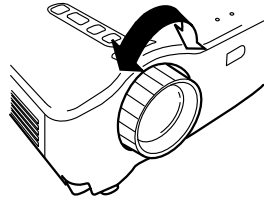

1. Turn the focus ring on the projector to adjust the focus.

Point:

- Focus cannot be achieved if the lens is dirty or covered with condensation. Wipe off any dirt or condensation (see page 66).
- If adjustment does not succeed, make sure the setup distance is between 1.0m (39.37inches) and 13.1m (515.75inches).

Keystone Correction (Using Projector Button)

When the foot levers are used to change the projection angle, the keystone correction function can be used to correct trapezoidal distortion upward or downward by roughly 15°.

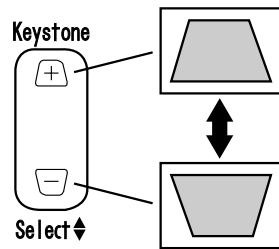

1. Press the Keystone button on the projector to minimize the trapezoidal distortion.

Point:

- A keystone correction reduces screen size.
- The keystone correction is stored in memory. You will need to readjust the image if the projector is moved to a different location or the projection angle is changed.
- If a keystone correction makes the image noticeably uneven, reduce the video sharpness with the menu commands Video > Sharpness (see page 48).

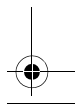
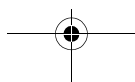
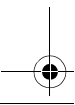
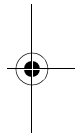
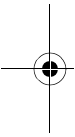

Adjusting Images (Remote Control Only)

[Optimizing Computer Video (Using the Auto button)]

This function applies automatically optimized adjustment values to a computer input signal.

If the input is a video signal, this function does not operate.

Adjusted values set automatically are "Tracking", "Position (vertical and horizontal)", and "Sync".

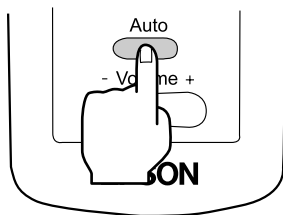

Point:

- This function cannot optimize the adjustment for some signal types. In these cases, use the Video Menu commands to perform adjustment (see page 47).
- When functions such as E-Zoom or A/V muting are engaged, press the Auto button to disengage these functions before adjustment.

[Opening a Menu For Adjustment]

Press the Menu button and perform adjustment using the Video Menu.

For details, refer to "Menu Screen Operations (Remote Control Only)" (see page 45).

Adjusting the Volume (Remote Control Only)

Press the Volume +, - button to adjust the volume to an easily audible listening level.

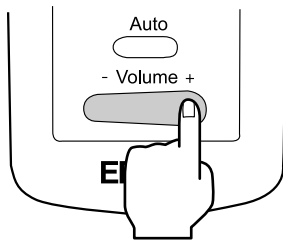

Point:

Adjustment is not available if there is no audio signal.



3.6 Ending After the Projection

Ending

1. Press the Power button. A "Power Off" confirmation message is displayed.

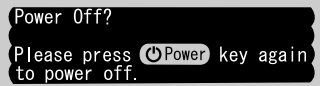

2. Press the Power button again.
The projector lamp goes out, the operation display indicator flashes orange, and after cool-down is complete, the indicator switches to steady orange.

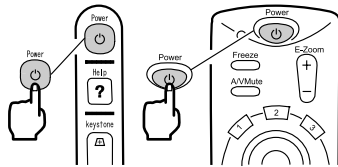

Point:

If you do not wish to shut the power, press another button.

Or, if no action is taken, the message disappears after 7 seconds.

3. Check that the operation display indicator lights orange.

Point:

- The flashing orange operation display indicator indicates that cool-down* (which takes about 2 minutes) is in progress. Buttons cannot be operated during cool-down (see page 74).
- If the power cord plug is pulled out of the outlet, the operation display indicator will go out.

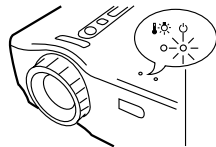

Operation display indicator lights orange.

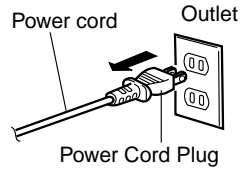

4. Pull the power cord plug out of the outlet.

Caution:

Do not pull the power cord plug out of the outlet while the operation display indicator is flashing orange. This may cause a malfunction or shorten the projector lamp life.

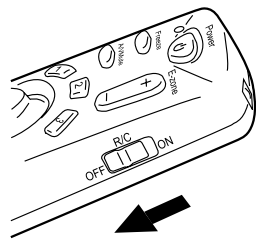

5. Set the remote control R/C On Off switch to Off.

Point:

Unless the remote control R/C On Off switch is switched off, a small amount of current will be supplied to the remote control and exhaust the batteries. If the remote control will not be used for a long period or you are moving the unit, set the remote control R/C On Off switch to Off.

Storage

When you are finished projecting, retract the foot levers into the unit.

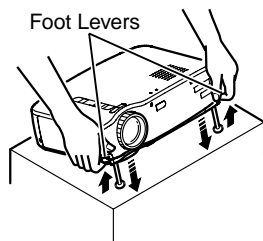

1. Support the projector unit with your hands, pull upward on the foot levers with your fingers, and lower the unit slowly.

2. Attach the lens cover.



4 What You Can Do

- 4.1 Using the Wireless Mouse 38
- 4.2 Enlarging an Image 40
- 4.3 Adjusting Image Size 41
- 4.4 Adding Image Effects 42
- 4.5 Freezing and Deleting Images..... 43
- 4.6 Displaying Help Screens 44

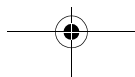
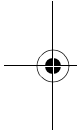

4.1 Using the Wireless Mouse

The remote control included allows you to control a computer's mouse operations at a separate location.

- The Esc button has the same action as a right mouse button, and the Enter button has the same action as a left mouse button.

〔 Mouse operation by remote control allows you to make a presentation at the screen without assistance. 〕

Presenter

Unassisted presentation is possible

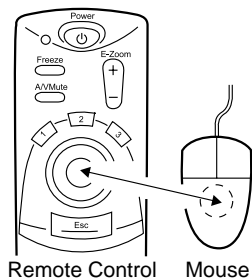
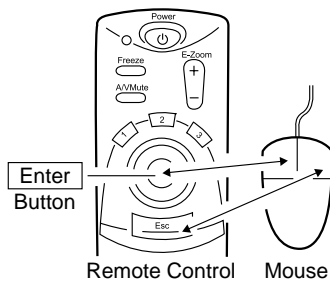
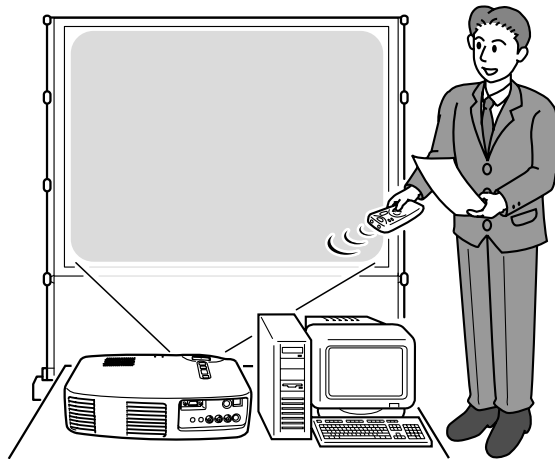

Point:

- If mouse button functions are swapped on your computer, the functions on the remote control also change as follows.

Esc Button: Left mouse button

Enter Button: Right mouse button

- This function cannot be used while an Effect Function, E-Zoom function, menu function, or Help function is in use.

Making a Connection

Before making a connection, switch off power to the projector and computer.

Caution:

- Connecting a non-USB mouse cable with the power on can cause malfunction or failure.
- Use only the mouse cable supplied. Any other cable may cause failure.

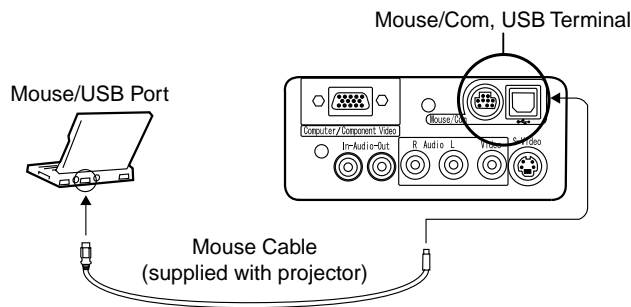

Computer	Mouse Cable	Connection Method
IBM PC/AT Compatible (DOS/V Machine)	PS/2 Mouse Cable	Connect the computer mouse port and the projector Mouse/Com terminal.
Computer for USB* Mouse (see page 74)	USB Mouse Cable	Connect the computer USB port and the projector USB mouse terminal.

When using a USB mouse, note the following.

- Windows

The only compatible models are those pre-installed with the standard USB interface configuration in Windows2000 and Windows98.
Operation is not guaranteed in environments upgraded from Windows3.1 and Windows95 to Windows98 and Windows2000.
- Macintosh

The only compatible models are those with the standard USB interface configuration.
* The USB interface does not guarantee operation of all USB-compatible devices.



4.2 Enlarging an Image

The remote control included lets you enlarge portions of an image.

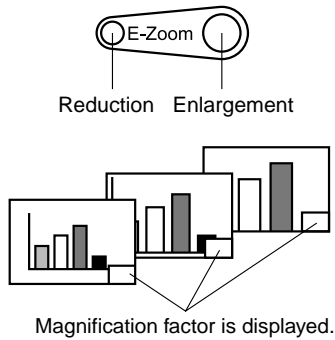

1. Press the E-Zoom button on the remote control to enlarge or reduce the display on screen.
(The Esc button releases this feature.)

Point:

24-step partial enlargement and reduction by factors of 1x-4x is available.

2. Push the Enter button in any direction to scroll in that direction.

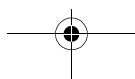
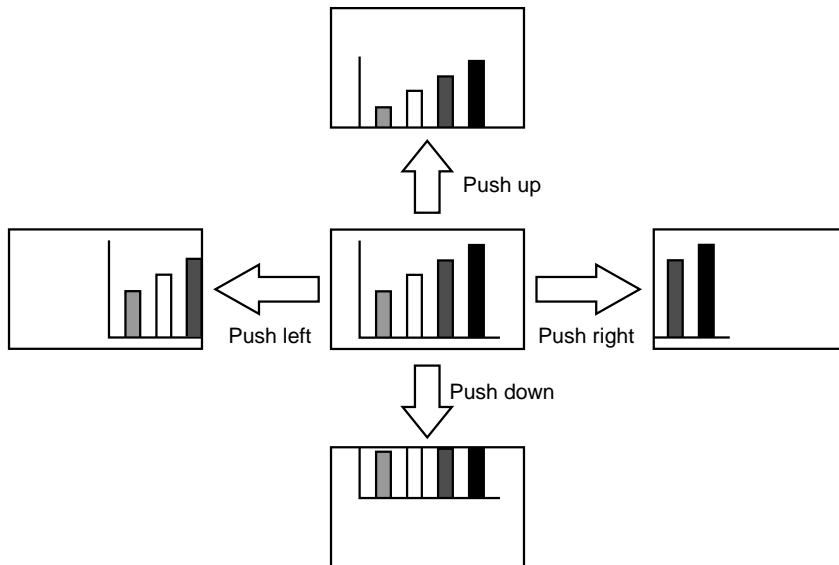



4.3 Adjusting Image Size

The Wide/Tele button on the projector allows you to adjust the size of images.

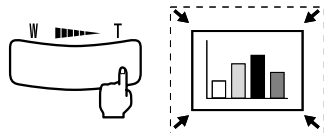

1. When you press the right side of the button (Tele), images are reduced.

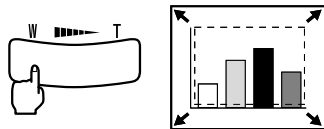

2. When you press the left side of the button (Wide), images are enlarged.

Point:

- The enlargement/reduction range that the Tele and Wide buttons provide is from 0.8x to 1.0x in 32 steps.
- This function is active until the Reset All menu is executed (see page 55).

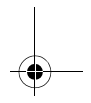
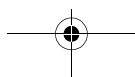
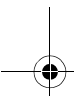
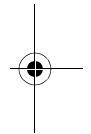
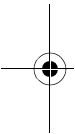



4.4 Adding Image Effects

Using the Effect1 and Effect2 buttons, you can add effects to images during presentation (to cancel this function, press the Esc button).
For effects settings, see "5.4 Effect Menu" (page 50).

Cursor/Stamp

This effect displays a cursor on the screen and freezes it at a desired location.

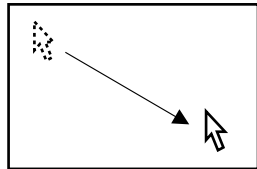

1. Press the Effect1 button to display a cursor.
2. Use the Enter button to move the cursor to a desired location.
3. Press the Enter button, and the cursor position is displayed as a stamp.

Point:

- To remove the cursor stamp display, activate a horizontal bar.
- To remove the stamp, press the Effect3 button.

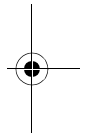
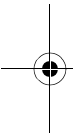

Horizontal Bar

This effect displays a horizontal line on the screen and allows you to move it up or down by remote control.

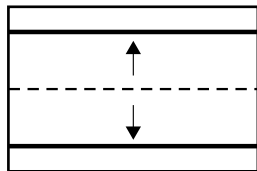
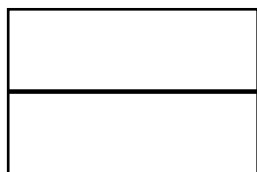

1. Press the Effect2 button to display a horizontal bar.

2. Move the Enter button up or down to move the horizontal bar up or down.

Point:

- To remove the horizontal bar, activate the cursor/stamp.

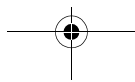



4.5 Freezing and Deleting Images

Freezing a Moving Image (Remote Control Only)

You can freeze a moving image (video or other image).

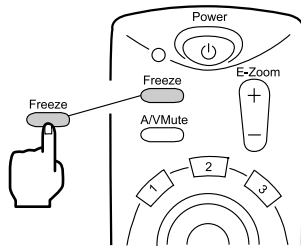

1. Press the Freeze button on the remote control.
(To release the freeze, press the Freeze button again.)

Muting Images and Sound (Remote Control Only)

You can temporarily mute images and sound and project a black or blue image.

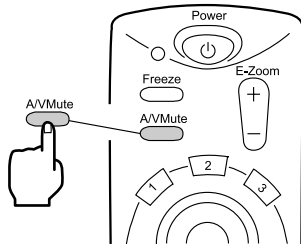

1. Press the A/V Mute button on the remote control.
(To cancel the muting feature, press the A/V Mute button or another button.)

Point:

Using the Setting > A/V Mute menu, you can change the color (black, blue) of the image projected when audio and video have been muted (see page 52).

4.6 Displaying Help Screens

You can display topic-specific help on screen for solving problems. Use this function when problems occur.

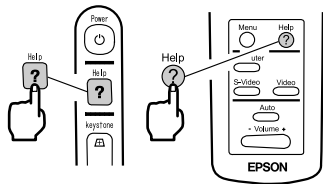

1. Press the Help button to start the help function.
(Press the Help button again to cancel this function.)

Point:

If you cannot solve your problem using the Help function, consult the "Troubleshooting" section in this manual (see page 57).

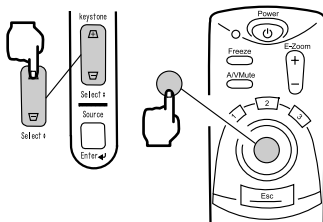

2. Use the Select button on the projector to select a topic (on the remote control, use the Enter button).

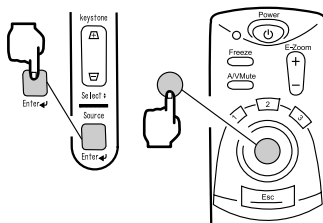
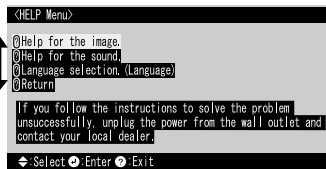

3. Press the Enter button to enter your selection.
4. Select a detailed topic as described in steps 2 and 3 and follow the instructions displayed.



5 Menu Functions (Remote Control Only)



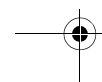
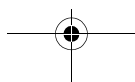

5.1	Learning Basic Operations	46
5.2	Video Menu	47
5.3	Audio Menu	49
5.4	Effect Menu	50
5.5	Setting Menu	51
5.6	Advanced Menu	53
5.7	About Menu	54
5.8	Reset All Menu	55



5.1 Learning Basic Operations

This section presents the basic functions available in menus.
For functions in each menu, access the guide available under each menu.

[Explanation of symbols]

-  : Push the Enter button to the upper or lower side.
  : Push the Enter button to the left or right side.
-  : Press the Enter button.
  : Press the Esc button.

[Opening and Closing Menus]

Press the Menu button to display the top menu.
To close this menu, press the Menu button again.
When the Menu button is pressed to close the top menu, the status at close will be maintained.

[Menu Selection]

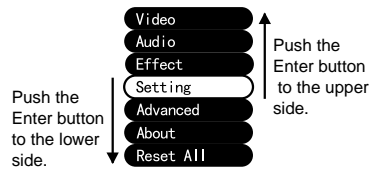

Push the Enter button to the upper or lower side to move the menu up or down.

[Moving in Hierarchy Structure Sub-menu selection]

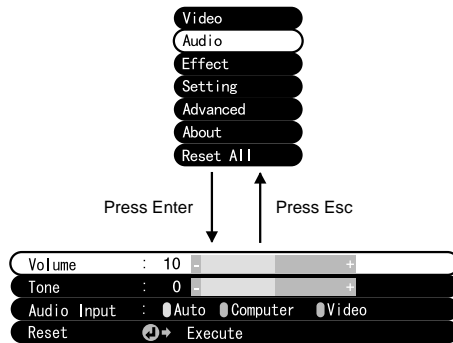

Press the Enter button to move to the sub-menus.

Press the Esc button to return to the top menu.

Press the Menu button to clear the menu display.

5.2 Video Menu

Displaying Menus

Press the Menu button, use the Enter button to select "Video" from the top menu displayed, and press the Enter button to move to a submenu.

Point:

- When there is no video signal from a computer or component video device, the "Video" menu is not available for settings.
- When there is no video signal from a video device, only the "Mode" menu is available for settings.

Settings

Video menu elements to be set differ as follows when projecting computer/component video versus video images.

Computer/Component Video Projection

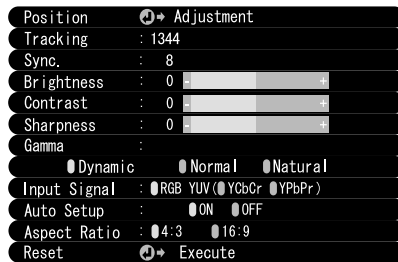

Video Projection

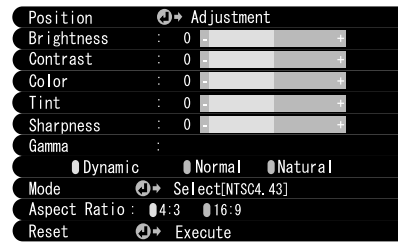

D-Sub15: Computer/Component video Video: Video image

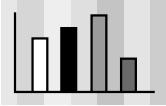
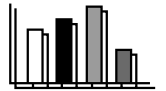
Menu	Content	Video Projection	
		D-Sub15	Video
Position	Adjust video position vertically and horizontally. * After position is adjusted, changes in the video signal from a computer (such as changes in output mode or display color) may change the adjusted value.	○	○
Tracking	Adjust when broad vertical streaks appear in image. (Available for setting only when input signal is RGB). 	○	×
Sync.	Adjust when flickering or blurring occurs (available for setting only when input signal is RGB). * When tracking is wrong, adjustment of sync will not correct flickering. Always adjust tracking before adjusting sync. 	○	×

○: setting available ×: setting not available

D-Sub15: Computer/Component video Video: Video image

Menu	Content	Video Projection	
		D-Sub15	Video
Brightness	Adjusts image brightness. +: Brightens image. - : Darkens image.	○	○
Contrast	Adjusts difference in color brightness/darkness. +: Increases difference in color brightness/ darkness. - : Decreases difference in color brightness/ darkness.	○	○
Color	Adjusts color depth. +: Deepens color. - : Lightens color.	×	○
Tint	Adjusts tint. +: Strengthens red. - : Strengthens green.	×	○
Sharpness	Adjusts image sharpness. +: Strengthens sharpness and defines image. - : Weakens sharpness and softens image. * If keystone correction makes unevenness distinctive, reduce the sharpness.	○	○
Gamma	Adjusts color of projected image. Dynamic : Increases contrast. (Used when projecting images containing text and graphics) Normal : Sets normal contrast. Natural : Weakens contrast to natural colors. (Used to give projected images a more natural look)	○	○
Input Signal	Select the input signal of the computer/ component video in use. RGB: Computer images YUV: Color difference images YCbCr: DVD images YPbPr: HDTV images	○	×
Auto Setup	Optimizes computer input image. (Can only be set when the input signal is RGB) ON : Auto Setup active OFF : Auto Setup not active	○	×
Mode	Select the video mode to use. * Selection of Auto provides automatic video signal identification, but for PAL (60Hz) mode, set to Manual.	×	○
Aspect Ratio	Select the aspect ratio. (Can only be set when projecting a component video image (YCbCr, YPbPr).)	○	○
Reset	Returns Video menu settings to factory shipping values. * See page 56 for factory shipping values. To reset all menus to factory shipping values, use the "Reset All" menu.	○	○

○ : setting available × : setting not available



5.3 Audio Menu

Displaying Menus

Press the Menu button, use the Enter button to select "Audio" from the top menu displayed, and press the Enter button to move to a submenu.

Settings

Menu	Content
Volume	Adjusts the volume of sound output from the projector. +: Increases volume. - : Decreases volume.
Tone	Adjusts the tone of sound output from the projector. +: Increases treble. - : Decreases treble.
Audio Input	Select an audio input destination. (When the input signal is a component video signal, select Video.) Auto : Audio input matching that of the displayed video is selected. (Example: When computer video is displayed, computer audio input is selected). Computer : Audio input from computer is selected. Video : Audio input from an A/V device is selected.
Reset	Returns Audio menu settings to factory shipping values. * See page 56 for factory shipping values. To reset all menus to factory shipping values, use the Reset All menu.

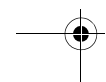
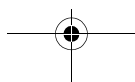



5.4 Effect Menu

Displaying Menus

Press the Menu button, use the Enter button to select "Effect" from the top menu displayed, and press the Enter button to move to a submenu.

Settings

Menu	Content
Cursor/Stamp	Make detailed settings for the cursor/stamp function assigned to the remote control Effect1 button. Shape : Select the shape of the cursor/stamp. Zoom Rate : Select the display zoom factor for the cursor/stamp.
Horizontal Bar	Make detailed settings for the horizontal bar function assigned to the remote control Effect2 button. Color : Select the horizontal bar color. Width : Select the width of the horizontal bar from 2-20 dots (in 2-dot steps).
Cursor Speed	Set the cursor speed. L : Low M : Medium H : High
Reset	Returns Effect menu settings to their factory shipping values. * See page 56 for factory shipping values. To reset all menus to factory shipping values, use the Reset All menu.



5.5 Setting Menu

Displaying Menus

Press the Menu button, use the Enter button to select "Setting" from the top menu displayed, and press the Enter button to move to a submenu.

Settings

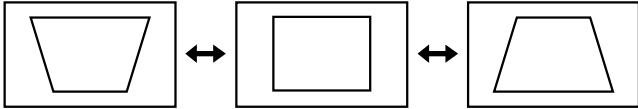
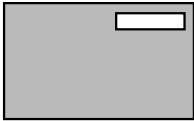
Menu	Content
Keystone	<p>If the screen is distorted in trapezoidal form, adjust it to normal display.</p> <p>-: Broadens upper screen Normal screen +: Broadens lower screen</p>  <ul style="list-style-type: none"> * You can also adjust the screen with the Keystone button on the projector. * A keystone correction reduces screen size. * The keystone correction is stored in memory. You will need to readjust the image if the projection angle is changed. * If a keystone correction makes the image noticeably uneven, reduce the video sharpness with the menu commands Video > Sharpness.
No-signal/Msg	<p>Set the screen display when there is no video signal.</p> <p>OFF : No message is displayed. (Screen displays black.)</p> <p>Black : "No-signal" is displayed on a black background (when the language is English).</p> <p>Blue : "No-signal" is displayed on a blue background (when the language is English).</p>
Prompt	<p>Set whether the input source currently selected is displayed/not displayed on the screen.</p> <p>ON : After input source switching, the input source is displayed for approximately 3 seconds.</p>  <p>OFF : The input source is not displayed.</p>



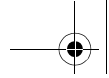

Menu	Content
A/V Mute* (See page 74)	Temporarily eliminates video during a presentation in order to focus attention on the presenter or elsewhere. Press the A/V Mute button to use this function. Black : A black screen is displayed. Blue : A blue screen is displayed.
Sleep Mode	After sleep mode is activated, the projector enters standby mode when no signal is input from an external source for a continuous period of 30 minutes. ON : Sleep Mode active OFF : Sleep Mode inactive
Reset	Returns Setting menu settings to their factory shipping values. * See page 56 for factory shipping values. To reset all menus to factory shipping values, use the Reset All menu.

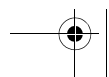
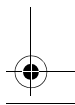
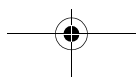
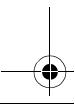
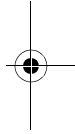
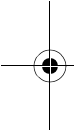



5.6 Advanced Menu

Displaying Menus

Press the Menu button, use the Enter button to select "Advanced" from the top menu displayed, and press the Enter button to move to a submenu.

Settings

Menu	Content
Language	Select the menu language. Select from Japanese, English, German, French, Italian, Spanish, Portuguese, Chinese and Korean.
Color Setting	Use color temperature or RGB to create settings for the colors displayed on screen. Color Temp: Adjusts the color temperature of the video. Select "Color Temp" and press the Enter button to create settings. The setting unit is Kelvins (K). + : Increases color temperature (strengthens blue). - : Decreases color temperature (strengthens red). RGB: Adjusts red, green, and blue intensity. Select "RGB" and press the Enter button to create settings. + : Strengthens color. - : Weakens color.
Rear Proj.	This setting is used for projection from the rear of a screen. ON : Inverts a projected image vertically. OFF : Restores original.
Ceiling	This setting is used for projection with the projector hanging from a ceiling. ON : Inverts a projected image vertically and horizontally. OFF : Restores original.
Reset	Returns Advanced menu settings to their factory shipping values. * See page 56 for factory shipping values. To reset all menus to factory shipping values, use the Reset All menu.

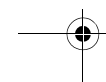
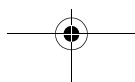

5.7 About Menu

Displaying Menus

Press the Menu button, use the Enter button to select "About" from the top menu displayed, and press the Enter button to move to a submenu.

Setting and Display Information

The settings information displayed in the About menu differs as shown below during video projection from a computer/component versus a video device.

Computer/Component Video Projection

Lamp	: 0 H
Reset Lamp Timer	: Execute
Video Source	: Computer
Input Signal	: RGB
Frequency	: H 48.52 kHz
	: V 60.1 Hz
SYNC Polarity	: H Positive
	: V Negative
SYNC Mode	: Separate Sync
Resolution	: 1024 x 768
Refresh Rate	: 60.1 Hz

Video Projection

Lamp	: 0 H
Reset Lamp Timer	: Execute
Video Source	: Video
Video Signal	: Auto (NTSC4, 43)

D-Sub15: Computer/Component video Video: Video image

Menu	Content	Video Projection	
		D-Sub15	Video
Lamp	Displays cumulative lamp-on time.	<input type="radio"/>	<input type="radio"/>
Reset Lamp Timer	Sets cumulative lamp-on time to zero. Use this function when replacing the lamp.	<input type="radio"/>	<input type="radio"/>
Video Source	Displays the source for the video displayed on screen.	<input type="radio"/>	<input type="radio"/>
Input Signal	Displays a computer/component video input signal.	<input type="radio"/>	<input type="checkbox"/>
Frequency	Displays frequencies. H: Displays the horizontal scanning frequency. V: Displays the vertical scanning frequency.	<input type="radio"/>	<input type="checkbox"/>
SYNC Polarity	Displays sync polarity.	<input type="radio"/>	<input type="checkbox"/>
SYNC Mode	Displays sync attributes.	<input type="radio"/>	<input type="checkbox"/>
Resolution	Displays input resolution.	<input type="radio"/>	<input type="checkbox"/>
Refresh Rate	Displays refresh rate (vertical frequency).	<input type="radio"/>	<input type="checkbox"/>
Video Signal	Displays an A/V device signal mode. (When set to Auto in the menu, "Auto (NTSC)" is displayed.)	<input type="checkbox"/>	<input type="radio"/>

: Display : No display



5.8 Reset All Menu

Displaying Menus

Press the Menu button, and use the Enter button to select "Reset All" from the top-level menu displayed.

Settings

Menu	Content
Reset All	Returns all menu settings to initial settings. (Lamp and language settings excluded) * Note that rear and invert settings will also be cleared by this operation.

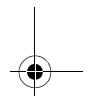
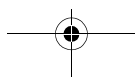
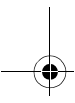
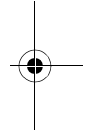
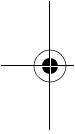

Initial Settings List

Initial settings at product shipment are shown below.

Main Menu Title	Submenu Title	Initial Settings
Video (Computer/ Component Video)	Position	Central value
	Tracking	Dependent on the connected signal
	Sync.	0
	Brightness	Central value
	Contrast	
	Sharpness	
	Gamma	Normal
	Input Signal	RGB
	Auto Setup	ON
	Aspect Ratio	4:3
Video (Video)	Position	Central value
	Brightness	
	Contrast	
	Color	
	Tint	
	Sharpness	
	Gamma	Normal
	Mode	Auto
	Aspect Ratio	4:3
Audio	Volume	Central value
	Tone	
	Audio Input	Auto
Effect	Cursor/Stamp	Shape:  Zoom Rate: 100%
	Horizontal Bar	Color: Magenta Width: 2
	Cursor Speed	M
Setting	Keystone	Central value
	No-Signal Msg	Blue
	Prompt	ON
	A/V Mute	Black
	Sleep Mode	OFF
Advanced	Language	
	Color Setting	Color Temp, (Computer/Component video: 7500K, Video: 6700K)
	Rear Proj.	OFF
	Ceiling	



6 Troubleshooting

6.1	Possible Failures.....	58
6.2	When Indicators Do Not Help.....	60

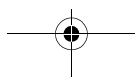

6.1 Possible Failures

If you think your projector may have failed, first check the indicators on the unit.

Your projector includes an "operation display indicator" and a "problem/alarm display indicator" which provide information on projector status.

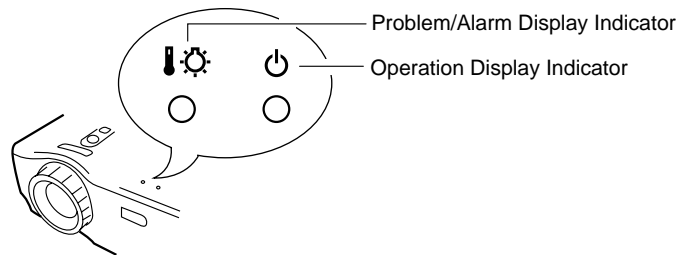

Operation Display Indicator

Indicator Status	Cause	Remedy or Status	See Page
Steady orange	Standby status	(Not abnormal) Press the Power button to begin projection.	28
Flashing orange	Cool-down in progress	(Not abnormal) Please wait. Cool-down* time takes about 2 minutes. (see page 74).	35
		You cannot operate the Power button during cool-down. Press the button again after cool-down ends.	
Steady green	Projection in progress	(Not abnormal)	29
Flashing green	Warm-up in progress	(Not abnormal) Please wait. Warm-up time is approximately 30 seconds. After warm-up is complete, the flashing green indicator changes to steady green.	29
Not lit	No power	If the lamp has been replaced, check that the lamp and lamp cover are attached securely.	68
		Check the power cord connections.	28
		Check power at the outlet.	28

Problem and Alarm Display Indicator

Indicator Status	Cause	Remedy or Status	See Page
Steady red	High internal temperature	The usage temperature range of the projector is 5°C–35°C, and the projector should be used in this range.	77
		Place the projector in a well-ventilated location where air intake and exhaust vents are not blocked.	18
		Clean the air intake vent.	67
		While the indicator is red, turn off the lamp to lower the internal temperature of the projector.	-
Flashing red (1-second intervals)	Problem with lamp	Replace with new lamp. Model No: ELPLP13	68
		If the lamp is broken, handle pieces carefully to avoid injury, and consult an Epson Service Center for repair (video cannot be projected until the lamp is replaced).	-
		If the lamp or lamp cover is not attached securely, follow the replacement instructions to attach it securely.	68
Flashing red (2-second intervals)	Internal problem	Stop using the projector, pull the plug from the outlet, and consult your vendor or an Epson Service Center (listed at the end of this manual) for repair.	-
Flashing orange	High-speed cooling in progress	Not a problem, but projection will be interrupted automatically to prevent further temperature rise.	-
		The usage temperature range of the projector is 5°C–35°C, and the projector should be used in this range.	77
		Place the projector in a well-ventilated location where air intake and exhaust vents are not blocked.	18
		Clean the air intake vent.	67

Point:

- If the indicator is normal but you experience problems with video projection, refer to "When Indicators Do Not Help" on the following page.
- If the indicator display status is not shown in this table, consult your vendor.



6.2 When Indicators Do Not Help

Video is Not Projected

[Nothing is Displayed]



No Display

- **Is the lens cover still on?** See page 28
- **Have you turned the power off and then immediately on?** See page 35
The Power button cannot be operated immediately after the projection has been switched off. The Power button becomes operable after cool-down* is complete (See page 74).
- **Is Sleep Mode on?** See page 52
If Sleep Mode is set to on and no video signal is input for 30 minutes, the projector lamp shuts off automatically.
- **Is video brightness adjusted correctly?** See page 48
- **Is "A/V Mute" mode active?** See page 52
- **Is the computer's screen saver on or is the computer in power save mode?**

[A Message Appears]

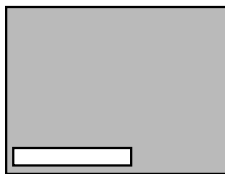

Display shows "Not Supported".

- **Is the resolution of the video signal output from your computer higher than SXGA (1280x1024)?** See page 23
- **Check that the frequency of the video signal output from your computer is a compatible mode.** See page 23
Consult your computer instruction manual for any changes to be made to the resolution or frequency of the video signal output from your computer.

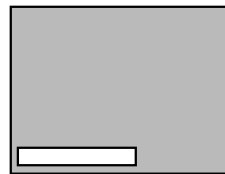

Display shows "No-Signal".

- **Are the cables connected correctly?** See pages 24, 25
- **Have you correctly selected the video input terminal connected?** See page 30
Press the Source button on the projector (Computer, Video, or S-Video on the remote control) to switch the video source.
- **Is power provided to a connected computer or A/V device?** See page 30
- **Is a video signal output from a connected computer or A/V device?**
- **When using a notebook computer or integrated LCD-type computer, a video signal must be output to the projector.** See page 31
A video signal is normally output only to an LCD screen, not externally. Switch the video signal to external output. Some computer models do not display video on an LCD



screen even when a video signal is output externally. Carefully review sections such as "Providing External Output" and "Providing Output to an Externally Connected Monitor" in the instruction manual of the connected computer.

Image is Unclear

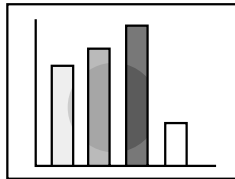

- Blurry image
- Image only partially focused
- Not focused at all

- **Is the focus adjusted correctly? See page 33**
- **Is the projection distance optimal? See page 20**
The recommended projection distance is 1.0m (39.37inches) to 13.1m (515.75inches) . Set up the projector in this range.
- **Is the lens dirty? See page 66**
- **Is the projection beam facing the screen directly? See page 18**
- **Is the lens covered with condensation?**
If you carry the projector from a cold room into a warm room, the lens may become covered with condensation and the image may be blurred. After a short period, the image should return to normal.
- **Press the Auto button on the remote control. See page 34**
- **Have you adjusted Sync.*, Tracking*, and Position? See page 47, 74**
Use the menu to adjust.
- **Are the video signal mode settings correct? See page 48**
Use the Menu > Video > Mode menu items to select a video signal format. Auto detection according to video signal input is not always possible.
- **Are the computer/component video signal settings correct? See page 48**
Select the correct input signal settings by selecting Menu > Video > Input Signal.
RGB: Computer images
YUV: Color difference images
YCbCr: DVD images
YPbPr: HDTV images

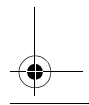
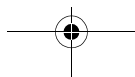
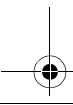
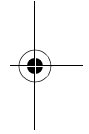
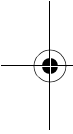

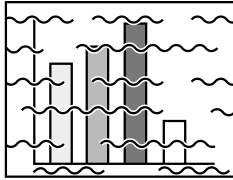

- Disturbed image
- Noisy

- **Are cables connected correctly?** See pages 24, 25
- **Is the correct resolution selected?** See page 23
Set your computer to provide a signal compatible with the projector. Consult your computer instruction manual with regard to modifying the signal.
- **Press the Auto button on the remote control.** See page 34
- **Have you adjusted Sync.*, Tracking*, and Position?** See page 47, 74
Use the "Menu" to adjust.
- **Are the video signal mode settings correct?** See page 48
Use the Menu > Video > Mode menu items to select a video signal format. Auto detection according to video signal input is not always possible.
- **Are the computer/component video signal settings correct?** See page 48
Select the correct input signal settings by selecting Menu > Video > Input Signal.
RGB: Computer images
YUV: Color difference images
YCbCr: DVD images
YPbPr: HDTV images
- **Are you using an cable included or one sold separately?** See page 72.
- **Are cables too long?**
A commercial video signal amplifier should be used with computer cables longer than 10m (393.70inches) .

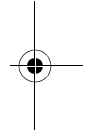
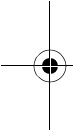
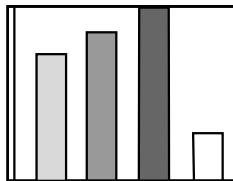

Image Disappears or is Undersized



- Image Disappears
- Undersized

- **Have you adjusted "Position"?** See page 47
Use the Menu > Video > Position menu items to adjust.
- **Is the correct resolution selected?** See page 23
Set your computer to provide a signal compatible with the projector. Consult your computer instruction manual with regard to modifying the signal.
- **Change the resolution of your notebook type or integrated LCD-type computer.** See page 31
Change the resolution to provide a full LCD display, or provide the video signal only to the external output.

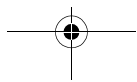
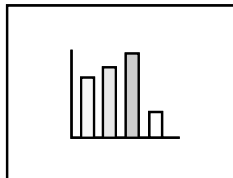
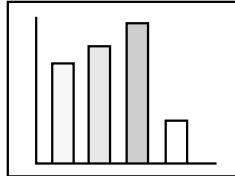

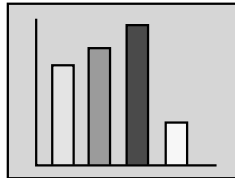

Image Color is Poor



- **Is image brightness adjusted correctly?** See page 48
- **Are cables connected correctly?** See pages 24, 25
- **Is contrast* adjusted correctly?** See pages 48, 74
- **Is color adjusted correctly?** See page 53
- **Are color depth and tint adjusted correctly?** See page 48
(Video tint and display to a computer monitor or LCD may not match, but this is not abnormal.)
- **Does the lamp need replacement?** See page 68
A nearly expired lamp can produce dark images or poor tint and should be replaced with a fresh lamp.
- **Are the computer/component video signal settings correct?** See page 48
Select the correct input signal settings by selecting Menu > Video > Input Signal.
RGB: Computer images
YUV: Color difference images
YCbCr: DVD images
YPbPr: HDTV images

Images Are Dark



- **Does the lamp need replacement?** See page 68
A nearly expired lamp can produce dark images or poor tint and should be replaced with a fresh lamp.
- **Is image brightness adjusted correctly?** See page 48
- **Is contrast* adjusted correctly?** See pages 48, 74

There is No Sound

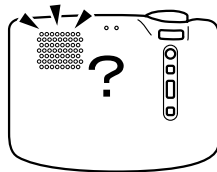

- **Are audio inputs connected correctly?** See page 24
- **Are audio outputs connected correctly?** See page 27
- **Have you selected the video whose audio you wish to output?** See page 30
- **Is volume adjusted to the minimum level?** See page 34
- **Is the A/V Mute function on?** See page 52
The A/V Mute mode may also be active.
Press the Volume button to release the A/V Mute.
- **Is the audio input setup correct?** See page 49
Select the correct audio signal by selecting Menu > Audio > Audio Input.

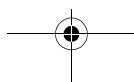

The Remote Control Does Not Operate



- **Is the remote control R/C On Off switch set to On?**
See page 29
- **Are you pointing the remote control in the correct direction for operation?** See page 15
The range of operation is approximately 30° left or right and approximately 15° above or below the remote control sensor on the projector.
- **Is the remote control too far from the projector?**
See page 15
The operable distance is approximately 10m (393.70inches).
- **Is the remote control receiver on the projector blocked?**
- **Is the remote control receiver in the path of direct sunlight or strong fluorescent light?**
- **Are batteries in place?** See page 16
- **Are the batteries worn?** See page 16
- **Are the batteries inserted correctly?** See page 16

Cannot Switch off (After Pressing the Power Button)

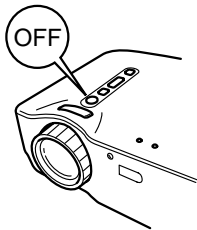

- **The operation display indicator remains a steady orange.**
The operation display indicator of the projector is designed to remain lit even after power is switched off. When the plug is pulled out of the outlet, the operation display indicator will go out.
- **The fan does not stop.**
After the Power button is pressed and power is turned off, cool-down* begins. See page 74
After cool-down, the operation display indicator lights orange, and you should pull the plug out of the outlet.
* Cool-down time varies depending on the external temperature and other factors.



7 Maintenance

- 7.1 Projector Cleaning, Lens Replacement,
Air Intake Vent Cleaning66
- 7.2 Lamp Replacement.....68

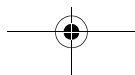



7.1 Projector Cleaning, Lens Replacement, Air Intake Vent Cleaning

Clean your projector when it is dirty or image projection is poor. Clean the air intake vent every 100 hours in practice.

Warning:

- *No one but trained service personnel should open the projector cabinet. The projector contains several high voltage components which can cause electric shock. For internal repairs, maintenance, and cleaning, take your projector to your vendor or an Epson Service Center.*
- *Use care when handling the power plug and connector. Improper handling may cause fire or electric shock. When handling the plug, observe the following.*
 - *Do not insert a plug or connector into an outlet or terminal if it is dirty or holds foreign matter.*
 - *Insert the plug and connector firmly and completely.*
 - *Do not pull out the plug or connector with wet hands.*

Caution:

- *Never attempt to remove the lamp immediately after use.*
 - *Heat may cause burns or other injury.*
 - *Wait approximately 60 minutes after switching off power and remove the lamp after the projector has cooled completely.*
- *When performing operations, pull the power plug and connector out of the outlet and terminal respectively.*

Switch off power to the projector and disconnect the power cord before cleaning.

Cleaning the Projector Unit

- Wipe dirt from the projector lightly with a soft cloth.
 - For heavier dirt, wipe the projector lightly with a cloth soaked in a weak solution of mild detergent and wrung out thoroughly, then dry with a separate cloth.
- Do not use waxes, benzene, thinners, or other volatile substances. These may degrade the cabinet or strip the finish.

Cleaning the Lens

Clean the lens with a commercial blower or lens cleaning paper. The surface of the lens is easily scratched and should not be rubbed or struck with hard objects.

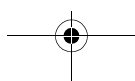



Cleaning the Air Intake Vents

Accumulated dust in the air intake vents degrades ventilation, increases the interior temperature, and can cause malfunction.

To prevent debris from entering the air intake vents, always stand the projector upright with the lens upward. Then use a vacuum cleaner or other equipment to suck dust from the vents.

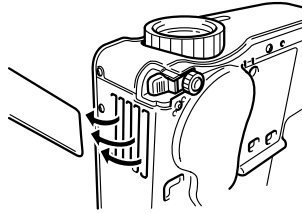

Point:

If it is no longer possible to remove the dirt from the air intake vent, it is time to replace it. Consult your vendor.

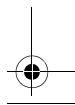
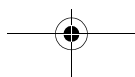
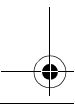
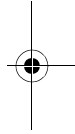
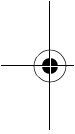

7.2 Lamp Replacement

Replace the lamp with a new lamp in the following instances.
 A replacement lamp is an optional part (sold separately).
 (Model No: ELPLP13)

[When the following message is displayed for 30 seconds after projection begins: "Lamp Replace. After the replacement of the lamp, reset the lamp timer under the direction in the user's manual."]

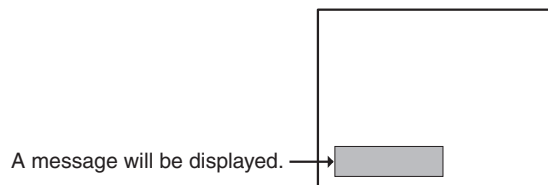

[When the problem/alarm display indicator flashes red at 1-second intervals.]

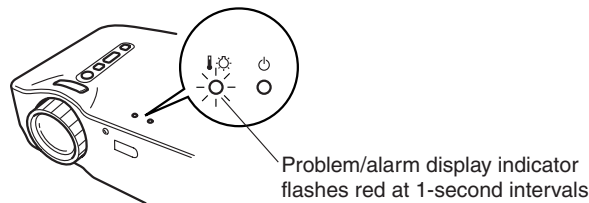

[When brightness or picture quality is inferior to its original state.]

Point:

- If the lamp does not light, replace it even if the lamp life has not expired.
- To maintain the original brightness and picture quality, replace the lamp as soon as possible after a replacement message appears.
- To maintain the original brightness and picture quality, replacement messages are set for approximately 1,400 hours.
- Though a replacement message appears at approximately 1,400 hours, individual lamp characteristics or usage conditions may cause failure before 1,400 hours, and we recommend that a replacement lamp be kept on hand.
- A replacement lamp can be purchased from your local Epson product vendor.

Replacement

Point:

- Install the lamp securely. For safety, when the lamp cover is opened, the abnormal warning display indicator flashes red, and the projector lamp goes out. If the lamp or lamp cover is installed improperly, the lamp will not light.

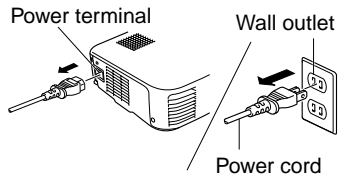

1. Switch off power to the projector and disconnect the power cord after cool-down* ends (see page 74). Cool-down time varies according to external temperature and other factors.

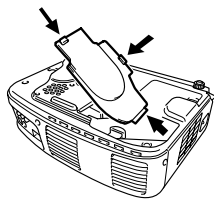

2. After the projector has cooled completely, remove the lamp cover.
 - The projector requires approximately 60 minutes to cool completely.
 - Press on the 2 catches and pull the cover out diagonally.

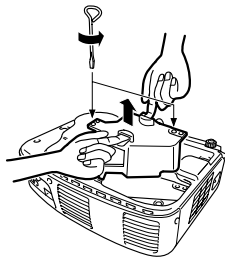

3. Pull the lamp out. Use a screwdriver to loosen the two lamp retaining screws, then grasp the holds and pull the lamp out.

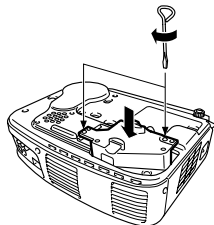

4. Install a new lamp. Align the lamp properly, insert the lamp until it contacts the rear of the housing, and use a screwdriver to tighten the two lamp retaining screws firmly.

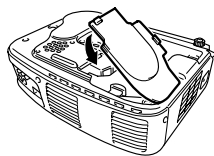

5. Install the lamp cover. Insert the cover diagonally and press it into the projector until you hear the catches click into place. Check that the catches are securely fastened.

Point:

After lamp replacement, use the About menu to reset lamp time to its initial value (see page 54).



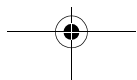
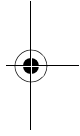
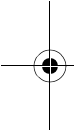
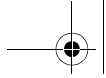



8 General Notes

8.1	Optional Parts	72
8.2	Shipping Instructions	73
8.3	Glossary	74
8.4	Index	75
8.5	Specifications	77
8.6	External Dimensions	78
8.7	International Warranty System	79

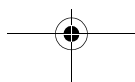



8.1 Optional Parts

The accessories shown below are available. Purchase these as your application requires.

- Replacement Lamp (ELPLP13)
Recommended for purchase before lamp life expires (screwdriver included).
- Portable screen
 - 50 inch screen: ELPSC06
 - 60 inch screen: ELPSC07
 - 80 inch screen: ELPSC08
- RGB extension cable
 - ELCCB05: 5m
 - ELCCB10: 10mUse if the computer cable included is not long enough.
(For mini D-sub 15-pin/mini D-sub 15-pin)
- Soft carrying case (ELPKS16, ELPKS24)
Used for projector transport.
- PC selector (ELPST01)
Use when multiple RGB signal sources are being used.
- Image Presentation Viewer (ELPDC01, ELPDC02, ELPDC03)
For use with paper, OHP copy, or in slide projection.
- Computer Cable
 - ELPKC02: 1.8m
 - ELPKC09: 3.0m
 - ELPKC10: 20mUse if the computer cable included is not long enough.
(For mini D-sub 15-pin/mini D-sub 15-pin)
- Mac Adapter Set (ELPAP01)
For use in connecting the projector to a Macintosh computer.
- Component Video Cable (ELPKC19: 3.0m)
(For Mini D-Sub 15-pin/RCA)
- D terminal cable (ELPKC22: 3.0m)
(For D-sub 15/D terminal)

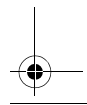
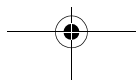
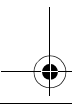
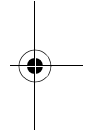
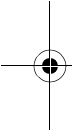

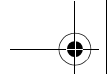

8.2 Shipping Instructions

Your projector includes numerous glass and precision components. When shipping your projector, treat it as follows to prevent malfunction caused by impacts.

Shipping to the Manufacturer for Repair

- Use the original shipping box.
- If you do not have the original shipping box, protect your projector against transmitted impacts by wrapping it in a shock-absorbing material and placing it in a strong cardboard box.

Hand-Carrying

- Use a soft carrying case (Model No: ELPKS16 or ELPKS24).
- During air travel, carry the projector on-board as hand luggage.

* Purchasers should bear in mind that the warranty does not apply to any malfunction arising during transportation.

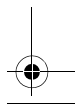
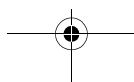
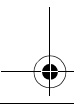
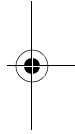
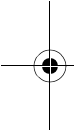



8.3 Glossary

This glossary provides brief explanations of terms which are used in this manual but are not explained in the text or difficult to understand. For details, refer to other available publications.

Term	Description
A/V Mute	Refers to temporary stoppage of audio and video. Your projector provides this function when the A/V Mute button is pressed. When the A/V Mute button is pressed again or audio volume is adjusted, this function is released.
SVGA	Refers to a 800-pixel (Pix) horizontal x 600-pixel (Pix) vertical display signal for an IBM PC/AT-compatible (DOS/V) computer.
SXGA	Refers to a 1280-pixel (Pix) horizontal x 1024-pixel (Pix) vertical display signal for an IBM PC/AT-compatible (DOS/V) computer.
Sync (synchronization)	Signals output by a computer are output at a certain predetermined frequency. If the frequency of your projector cannot match that frequency, a clear image cannot be obtained. Matching of signal phases (peak offset) is referred to as synchronization (synch). If synchronization is not achieved, a projected image displays jitters, blurring, and horizontal noise.
USB	An abbreviation for universal serial bus, an interface for connecting a personal computer with a relatively low-speed peripheral device.
VGA	Refers to a 640-pixel (Pix) horizontal x 480-pixel (Pix) vertical display signal for an IBM PC/AT-compatible (DOS/V) computer.
XGA	Refers to a 1024-pixel (Pix) horizontal x 768-pixel (Pix) vertical display signal for an IBM PC/AT-compatible (DOS/V) computer.
Cool-Down	After the Power button is pressed and the lamp goes out, lamp cooling is continued. After the lamp goes out, a cooling fan spins, and operational buttons become inactive. Cool-down time takes about 2 minutes.
Contrast	The enhancing or weakening of differences in color lightness and darkness that provides a sharper or softer view of characters and images. This adjustment is referred to as contrast adjustment.
Tracking	Signals output by a computer are output at a certain predetermined frequency. If the frequency of your projector cannot match that frequency, a clear image cannot be obtained. Matching of signal frequencies is referred to as matching tracking. When tracking is not matched, a projected image displays broad vertical bands.



8.4 Index

[A]

A/V Device 25
 A/V Mute 52
 A/V Mute Button 14, 43
 About Menu 54
 Adjusting 32, 34
 Advanced Menu 53
 Air Intake Vent 12
 Aspect Ratio 48
 Audio In Terminal 13, 24
 Audio Input 49
 Audio Menu 49
 Audio Out Terminal 13, 27
 Auto Button 14, 34
 Auto Setup 48

[B]

Battery Cover 14, 16
 Brightness 48

[C]

Ceiling 53
 Color 48
 Color Setting 53
 Compatible Mode 23
 Computer 22
 Computer Button 14, 30
 Computer Terminal 13, 24
 Connecting 24, 25
 Contrast 48
 Cursor Speed 50
 Cursor/Stamp 42, 50

[E]

Effect Button 14, 42
 Effect Menu 50
 Enter Button 14, 38, 46
 Esc Button 14, 38, 46

External Audio Device 27
 External Dimensions 78
 E-Zoom Button 14, 40

[F]

Focus Ring 12, 32
 Foot Lever 12
 Freeze Button 14, 43
 Frequency 54
 Front Foot 12, 32

[G]

Gamma 48

[H]

Help Button 13, 14, 44
 Help Screens 44
 Horizontal Bar 42, 50

[I]

Indicator 14
 Initial Settings 56
 Input Signal 48, 54
 Input/Output Terminals 12
 Inserting Batteries 16

[K]

Keystone 51
 Keystone (Select)
 Button 13, 33

[L]

L/R Audio Terminals 13, 25
 Lamp 54
 Lamp Cover 12
 Lamp Replacement 68
 Language 53
 Lens Cover 12

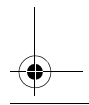
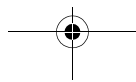
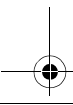
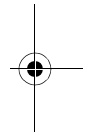
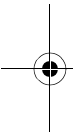



[M]

- Mac Mouse Cable 39
- Macintosh 39
- Menu Button 14, 46
- Mode 48, 54
- Mouse Cable 39
- Mouse/Com Terminal ... 13, 39

[N]

- No-signal 51
- Notebook 31

[O]

- Operating Panel 12
- Operation Display Indicator 12, 28, 29, 35, 58
- Optional Parts 72

[P]

- Position 47
- Power Button 13, 14, 29, 34
- Power Cord 28
- Power Terminal 12, 28
- Problem/Alarm Display Indicator 12, 59, 68
- Projection Distance 20
- Prompt 51
- PS/2 Mouse Cable 39

[R]

- R/C On Off Button ... 14, 29, 36
- Rear Foot 12
- Rear Projection 53
- Refresh Rate 54
- Remote Control 14, 15
- Remote Control Receiver ... 12
- Reset 48, 49, 50, 52, 53
- Reset All Menu 55
- Reset Lamp Timer 54
- Resolution 54

[S]

- Screen Size 20
- Setting Menu 51
- Setup Instructions 19
- Sharpness 48
- Shipping Instructions 73
- Sleep Mode 52
- Source (Enter) Button ... 13, 30
- Speaker 12
- Special Notes on Setup 18
- Specifications 77
- Storage 35
- S-Video Button 14, 30
- S-Video Terminal 13, 25
- SYNC Mode 54
- SYNC Polarity 54
- Sync. 47

[T]

- Term 74
- Tint 48
- Tone 49
- Tracking 47

[U]

- USB Mouse Cable 39
- USB Mouse Terminal ... 13, 39

[V]

- Video Button 14, 30
- Video Menu 47
- Video Source 54
- Video Terminal 25
- Volume 49
- Volume Button 14, 34

[W]

- Wide/Tele Button 12, 41
- Windows 39
- Wireless Mouse 38

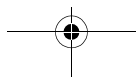
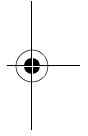
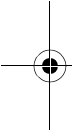



8.5 Specifications

Product	Multi-Media Projector		
Model	EMP-70/50		
Model	300(W) x 80(H) x 220(D)mm (11.81(W) x 3.15(H) x 8.46(D)inches) (not including protruding parts)		
Panel Size	0.7		
Display Format	Polysilicon TFT		
Pixel Count	<EMP-70> 786,432 (1,024 (Horizontal) x 768 (Vertical) dots) x 3 <EMP-50> 480,000 (800 (Horizontal) x 600 (Vertical) dots) x 3		
Focus Adjustment	Manual		
Zoom Adjustment	Electronic 0.8 : 1		
Lamp (Light Source)	UHE lamp, Rated 150W ELPLP13		
Maximum Audio Output	1W monaural		
Speaker	1		
Power Supply	100 – 240VAC 50/60Hz		
Power Consumption	2.4A – 1.2A		
Usage Temperature Range	+5°C – +35°C (No condensation)		
Storage Temperature Range	-10°C – +60°C (No condensation)		
Weight	Approx. 3.1kg (6.83lb)		
Connection Terminals	Computer/Component Video terminal	1 system	Mini D-Sub 15-pin (female)
	Audio In terminal (for computer)	1 system	Stereo mini-jack
	Mouse/Com terminal	1 system	DIN jack, 9-pin
	Video terminal	1 system	RCA pin jack
	S-Video terminal	1 system	Mini DIN, 4-pin
	Audio terminal (for video)	1 system	RCA pin jack x2 (L, R)
	Audio Out terminal	1 system	Stereo mini-jack
	USB terminal	1 system	USB connector (B-type)

Specifications may change without notice.



8.6 External Dimensions

The diagram below shows the EMP-70. The EMP-50 has the same external dimensions.

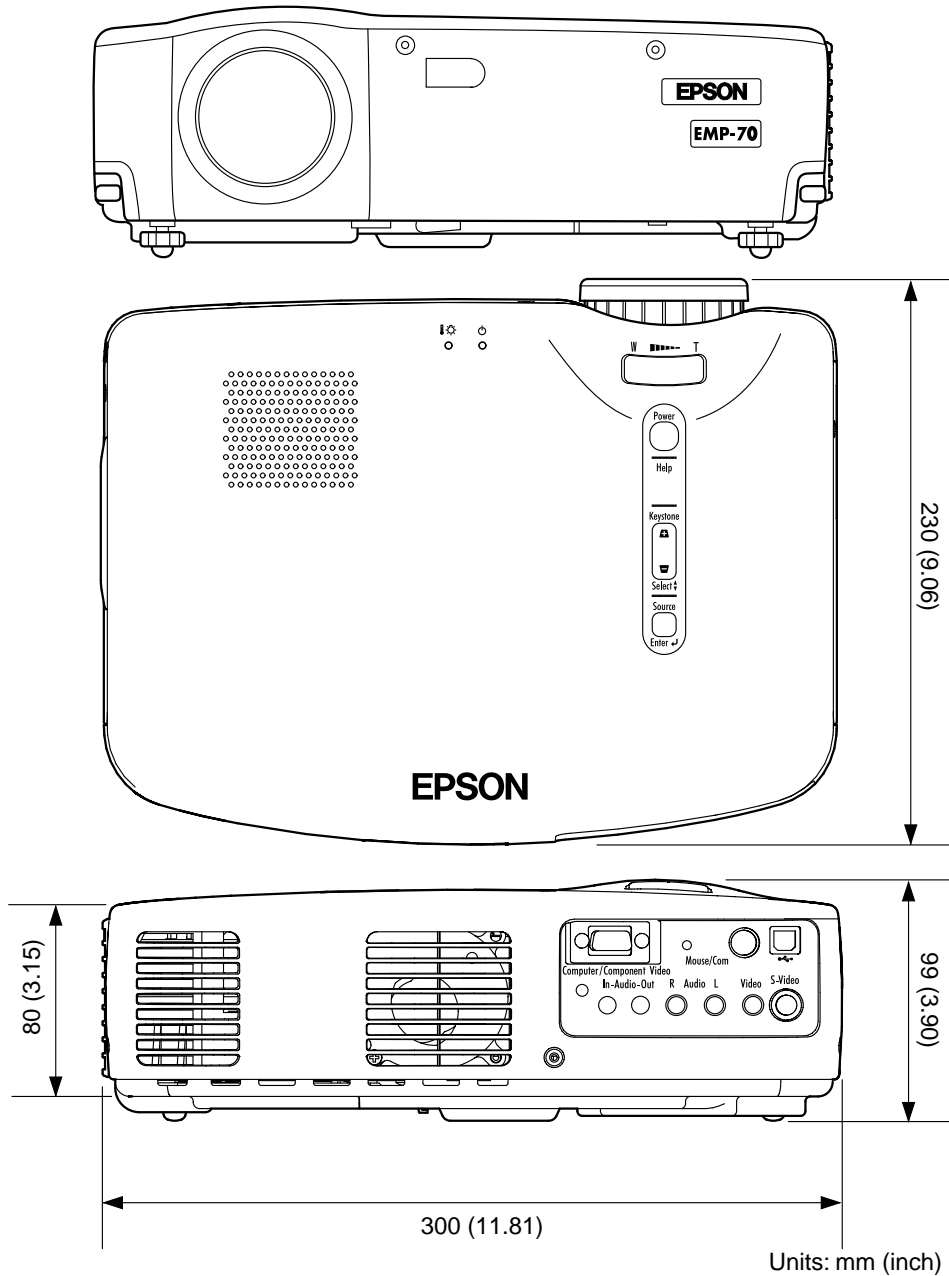

8.7 International Warranty System

Your unit is warranted internationally, and you can have it serviced in more than 45 countries outside the country of purchase. Please note that the provisions of the warranty document pertaining to your product are not those of the international warranty, and that your warranty applies only when receiving service in a country where the warranty is valid.

The international warranty for your Epson Image Presentation Projector applies only in the following countries.

<Europe>

- Austria
- Belgium
- Bulgaria
- Croatia
- Cyprus
- Czech Republic
- Denmark
- Finland
- France
- Germany
- Greece
- Hungary
- Ireland
- Italy
- Luxembourg
- Macedonia
- Netherlands
- Norway
- Portugal
- Poland
- Rumania
- Slovakia
- Slovenia
- Spain
- Sweden
- Switzerland
- Turkey
- United Kingdom
- Yugoslavia

<North America / Central America>

- Canada
- Costa Rica
- Mexico
- United States

<South America>

- Argentina
- Brazil
- Chili
- Colombia
- Peru
- Venezuela

<Asia / Oceania>

- Australia
- Hong Kong
- Japan
- South Korea
- Malaysia
- Singapore
- Taiwan
- Thailand

The following provisions specify your warranty term and conditions.

- 1) This warranty is valid on presentation of a warranty document or receipt issued in the country where the product was purchased.
- 2) This warranty shall be fulfilled as stipulated by Epson and Epson-designated service organizations in the countries listed in this manual.
 - The warranty period is 12 months from purchase.
 - This warranty extends to the cost of parts and labor as stipulated by the initial terms of the Epson warranty.
 - Loan of a replacement unit will generally not be provided during service.
- 3) This warranty shall not apply in the following circumstances.
 - a. Failure of wear items (lamp) or accessories
 - b. Improper use by the customer, damage due to shipping, or handling not in accordance with this manual
 - c. Service or modification by a third party other than Epson or an Epson-designated service organization
 - d. Problems occurring after the use of accessories or wear parts other than genuine Epson or Epson-quality assured accessories or parts.

Caution

The power cord included is based on the electric power specifications in the country of purchase. For use in other countries, purchase a genuine Epson power cable designed for use in the country concerned.

International Warranty Contact List for Epson Image Presentation Projectors

This contact list is current as of December 7, 2000. For the latest contact information, consult the online home page of the contact in each country, indicated below. If no information is shown, consult our main home page at www.epson.com.

**EUROPE**

AUSTRIA :
EPSON Support Center
Austria
Tech. Help Desk:
00491805 235470
Web Address:
<http://www.epson.at>

BELGIUM :
EPSON Support Center
BeNeLux
Tech. Help Desk: 032 70222082
Web Address:
<http://www.epson.be>

BULGARIA :
PROSOFT
6. AI Jendov Str.
BG-1113 Sofia
Tel: 00359.2.730.231
Fax: 00359.2.9711049
E-mail: Prosoft@internet-BG.BG

CROATIA :
Recro d.d.
Trg. Sportova 11
HR-10000 Zagreb
Tel: 00385.1.6350.777
Fax: 00385.1.6350.716
E-mail: recro@recro.hr
Web Address:
<http://www.recro.hr>

CYPRUS :
CTC- INFOCOM
6a. Ionos Str., Engomi
P. O. Box 1744
2406 Nicosia, Cyprus
Tel: 00357.2.458477
Fax: 00357.2.668490

CZECH :
EPRINT s.r.o.
Stresovicka 49
CZ-16200 Praha 6
Tel: 00420.2.20180610
Fax: 00420.2.20180611
E-mail: eprint@mbox.vol.cz

DENMARK :
Tech. Help Desk: 80881127

FINLAND :
Tech. Help Desk: 0800.523010
(note. Some geographical
areas excluded)

FRANCE :
EPSON France,
68 bis rue Marjolin, F-92300
Levallois,
Tech. Help Desk: 01.49.61.33.95
Web Address:
<http://www.epson.fr>

GERMANY :
EPSON Deutschland
GmbH
Zülpicher Straße 6
40549 Düsseldorf
Tech. Help Desk: 01805 235470
Web Address:
<http://www.epson.de>

GREECE :
Pouliadis Ass. Corp.
Aristotelous St. 3
GR-19674 Athens
Tel: 0030.1.9242072
Fax: 0030.1.9441066

HUNGARY :
R.A. Trade Kft.
Petöfi Sandor u. 64
H-2040 Budaör
Tel: 0036.23.415.317
Fax: 0036.23.417.310

IRELAND :
Tech. Help Desk: 01.6799016

ITALY :
EPSON Italia s.p.a.
Assistenza e Servizio Clienti
Viale F. Lli Casiragi, 427
20099 Sesto
San Giovanni (MI)
Tech. Help Desk: 02.29400341
Web Address:
<http://www.epson.it>

LUXEMBURG :
EPSON Support Center
BeNeLux
Tech. Help Desk:
0032 70 222082
Web Address:
<http://www.epson.be>

MACEDONIA :
Rema Kompjuteri d.o.o.
St. Naroden Front 19a lok 16
91000 Skopje/ Macedonia
Tel: 00389.91.118159
Fax: 00389.91.118159

NETHERLANDS :
EPSON Support Center
BeNeLux
Tech. Help Desk: 043 3515752
Web Address:
<http://www.epson.nl>

NORWAY :
Tech. Help Desk: 800.11828

PORTUGAL :
EPSON Portugal, S.A.
Rua do Progresso, 471-1
Perafita- Apartado 5132
Tech. Help Desk: 0808 200015
Web Address:
<http://www.epson.pt>

POLAND :
FOR EVER Sp. z.o.o.
Ul. Frankciska Kawy 44
PL- 01-496 Warszawa
Tel: 0048.22.638.9782
Fax: 0048.22.638.9786
E-mail: office@for-ever.com.pl

ROMANIA :
MB Distribution S.R. L.
162, Barbu Vacarescu Blvd.
Sector 2
RO- 71422 Bucharest
Tel: 0040.1.2300314
Fax: 0040.1.2300313
E-mail: office@mbd-epson.ro

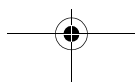



SLOVAKIA :
Print Trade spol. s.r.o.
Cajkovoškeho 8
SK-98401 Lucenec
Tel: 00421.863.4331517
Fax: 00421.863.4325656
E-mail: Prntrd@lc.psg.SK
Web Address:
<http://www.printrtrade.sk>

SLOVENIA :
Repro Ljubljana d.o.o.
Smartinska 106
SLO-1001 Ljubljana
Tel: 00386.61.1853411
Fax: 00386.61.1400126

SPAIN :
EPSON IBERICA, S.A.
Avda. Roma 18-26,
08290 Cerdanyola del Valles,
Barcelona, SPAIN
Centro At. Cliente: 902 404142
E-mail: soporte@epson.es
Web Address:
<http://www.epson.es>

SWEDEN :
Tech. Help Desk: 08 445 1258

SWITZERLAND :
EXCOM Service AG
Moosacher Str. 6
CH-8820 Wädenswil
Tel: 01.7822111
Fax: 01.7822349
Web Address:
<http://www.excom.ch>

TURKEY :
Romar Pazarlama
Sanayi ve TIC. A.S.
Rihtim Cad. No. 201
Tahir Han
TR-Karaköy-Istanbul
Tel: 0090.212.2520809
Fax: 0090.212.2580804

UNITED KINGDOM :
EPSON (UK) Ltd.
Campus 100, Maylands Avenue
Hemel Hempstead,
Herts, HP2 7TJ
Tech. Help Desk: 0990 133640
Web Address:
<http://www.epson.uk>

YUGOSLAVIA :
BS Procesor d.o.o.
Hadzi Nikole Zivkovic 2
11000 Beograd
Tel: 00381.11.639610
Fax: 00381.11.639610

**NORTH, CENTRAL
AMERICA & CARIBBEAN
ISLANDS**

CANADA :
Epson Canada, Ltd.
100 Mural Street, Suite 300
Richmond Hill, Ontario
CANADA L4B 1J3
Tel: 905-709-3839
Web Address:
<http://www.epson.com>

COSTA RICA :
Epson Costa Rica, S.A.
Embajada Americana,
200 Sur y 300 Oeste
San Jose, Costa Rica
Tel: (50 6) 296-6222
Web Address:
<http://www.epsoncr.com>

MEXICO :
Epson Mexico, S.A. de C.V.
AV. Sonora #150
Mexico, 06100, DF
Tel: (52 5) 328-4008
Web Address:
<http://www.epson.com.mx>

U. S. A. :
Epson America, Inc.
3840 Kilroy Airport Way
Long Beach, CA 90806
Tel: (562)276-4394
Web Address:
<http://www.epson.com>

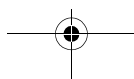



SOUTH AMERICA

ARGENTINA :
Epson Argentina S.A.
Avenida Belgrano 964/970
(1192), Buenos Aires
Tel: (54 11) 4346-0300
Web Address:
<http://www.epson.com.ar>

BRAZIL :
Epson Do Brasil Ltda.
Av. Tucunare, 720
Tambore Barueri,
Sao Paulo, SP 06460-020
Tel: (55 11) 7295-1757
Web Address:
<http://www.epson.com.br>

CHILE :
Epson Chile S.A.
La Concepcion 322
Providencia, Santiago
Tel: (562) 236-2543
Web Address:
<http://www.epson.cl>

COLOMBIA :
Epson Colombia Ltda.
Diagonal 109, 15-49
Bogota, Colombia
Tel: (57 1) 523-5000
Web Address:
<http://www.epson.com.co>

PERU :
Epson Peru S.A.
Av. Del Parque Sur #400
San Isidro, Lima, Peru
Tel: (51 1) 224-2336
Web Address:
<http://www.epson.com>

VENEZUELA :
Epson Venezuela S.A.
Calle 4 con Calle 11-1
La Urbina Sur
Caracas, Venezuela
Tel: (58 2) 241-0433
Web Address:
<http://www.epson.com.ve>

ASIA & OCEANIA

AUSTRALIA :
EPSON AUSTRALIA PTY
LIMITED
70 Gibbes Street Chatswood
NSW 2067 AUSTRALIA
Tel: 1300 361 054
Web Address:
<http://www.epson.com.au>

HONGKONG :
EPSON Technical
Support Centre
(Information Centre)
Rooms 4706-4710,
China Resources Building,
26 Harbour Road, Wan Chai,
HONG KONG
Tech. Hot Line: (852) 2585
4399
Fax: (852) 2827 4383
Web Address:
<http://www.epson.com.hk>

JAPAN :
SEIKO EPSON
CORPORATION
SHIMAUCHI PLANT
VD Customer Support Group:
4897 Shimauchi,
Matsumoto-shi, Nagano-ken,
390-8640 JAPAN
Tel: 0263-48-5438
Fax: 0263-48-5680
<http://www.i-love-epson.co.jp>

KOREA :
EPSON KOREA CO., LTD
17F HANSOL Bldg., 736-1,
Yaoksam-dong Kangnam-gu,
Seoul, 135-080, KOREA
Tel: 2-553-3515
Fax: 2-5584271
<http://www.epson.co.kr>

MALAYSIA :
EPSON TRADING
(MALAYSIA) SDN. BHD.
No. 21 Jalan U 1/19, Seksyen
U1, Hicom-grenmarie Industrial
Park, 40150 Shan Alam,
Selangor Darul Ehsan
Tel: 03-5191366
Fax: 03-5191386

SINGAPORE :
EPSON SINGAPORE
PTE. LTD.
401 Commonwealth Drive
#01-01 Haw Par Technocentre
SINGAPORE 149598
Tel: 4722822
Fax: 4726408

TAIWAN :
EPSON Taiwan
Technology & Trading Ltd.
10F, No.287, Nanking East
Road, Section 3, Taipei,
Taiwan,China
Tel: 02-2717-7360 ext. 327
Fax: 02-2713-2155
<http://www.epson.com.tw>

THAILAND :
EPSON (Thailand) Co.,Ltd.
24th Floor, Empire Tower,
195 South Sathorn Road,
Yannawa, Sathorn, Bangkok
10120, Thailand.
Tel: 6700680 Ext. 309,316,317
Fax: 6700688
<http://www.epson.co.th>
Epson Technical Center
21st Floor, Payathai Tower,
128/227 Payathai Road,
Rachataewee, Bangkok 10400,
Thailand.
Tel: 6120291~3
Fax: 2165005
<http://www.epson-tech.in.th>



DECLARATION of CONFORMITY
according to ISO/IEC Guide 22 and EN 45014

Manufacturer : SEIKO EPSON CORPORATION
Address : 3-5, Owa 3-chome, Suwa-shi,
Nagano-ken 392-8502 Japan

Representative : EPSON EUROPE B. V.
Address : Entrada 701, 1096 EJ
AMSTERDAM, The Netherlands

Declares that the Product

Kind of Equipment : LCD Projector

Model : ELP-70 / EMP-70
ELP-50 / EMP-50

Conforms to the following Directives and Norm(s)

Directive 89/336/EEC

: EN 55022
: EN 55024

Directive 73/23/EEC

: EN 60950

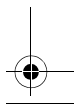
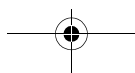
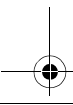
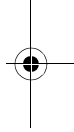
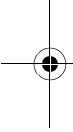



DECLARATION of CONFORMITY

According to 47CFR, Part 2 and 15 for
**Class B Personal Computers and Peripherals; and/or
CPU Boards and Power Supplies used with Class B
Personal Computers**

We : EPSON AMERICA, INC.
Located at : MS: 3-13
3840 Kilroy Airport Way
Long Beach, CA 90806-2469
Telephone: (562) 290- 5254

Declare under sole responsibility that the product identified herein, complies with 47CFR Part 2 and 15 of the FCC rules as a Class B digital device. Each product marketed, is identical to the representative unit tested and found to be compliant with the standards. Records maintained continue to reflect the equipment being produced can be expected to be within the variation accepted, due to quantity production and testing on a statistical basis as required by 47CFR 2.909. Operation is subject to the following two conditions : (1) this device may not cause harmful interference, and (2) this device must accept any interference received, including interference that may cause undesired operation.

Trade Name : EPSON
Type of Product : LCD Projector
Model : EMP-70/50 / ELP-70/50

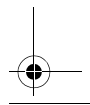
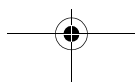
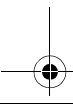
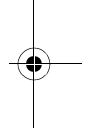
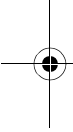



FCC Compliance Statement For United States Users

This equipment has been tested and found to comply with the limits for a Class B digital device, pursuant to Part 15 of the FCC Rules. These limits are designed to provide reasonable protection against harmful interference in a residential installation. This equipment generates, uses, and can radiate radio frequency energy and, if not installed and used in accordance with the instructions, may cause harmful interference to radio or television reception. However, there is no guarantee that interference will not occur in a particular installation. If this equipment does cause interference to radio and television reception, which can be determined by turning the equipment off and on, the user is encouraged to try to correct the interference by one or more of the following measures.

- Reorient or relocate the receiving antenna.
- Increase the separation between the equipment and receiver.
- Connect the equipment into an outlet on a circuit different from that to which the receiver is connected.
- Consult the dealer or an experienced radio/TV technician for help.

WARNING

The connection of a non-shielded equipment interface cable to this equipment will invalidate the FCC Certification or Declaration of this device and may cause interference levels which exceed the limits established by the FCC for this equipment. It is the responsibility of the user to obtain and use a shielded equipment interface cable with this device. If this equipment has more than one interface connector, do not leave cables connected to unused interfaces. Changes or modifications not expressly approved by the manufacturer could void the user's authority to operate the equipment.

For Canadian Users

This digital apparatus does not exceed the Class B limits for radio noise emissions from digital apparatus as set out in the radio interference regulations of the Canadian Department of Communications.
Le présent appareil numérique n'émet pas de bruits radioélectriques dépassant les limites applicables aux appareils numériques de Classe B prescrites dans le règlement sur le brouillage radioélectrique édicté par le Ministère des Communications du Canada.

