



LCD TELEVISION

INSTRUCTION MANUAL

DSL-15D3

DSL-17D3

DSL-20D3

DSL-15D4

DSL-17D4

DSL-20D4

PAL B/G, D/K, I/I,

SECAM B/G, D/K, L/L', NTSC(AV)

TELETEXT

SCART/VIDEO/S-VIDEO/COMPONENT/PC

MULTI-LANGUAGE OSD

Caution



CAUTION
RISK OF ELECTRIC SHOCK
DO NOT OPEN

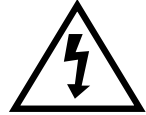

**CAUTION : TO REDUCE THE RISK OF ELECTRIC SHOCK,
DO NOT REMOVE COVER (OR BACK).
NO USER-SERVICEABLE PARTS INSIDE.
REFER SERVICING TO QUALIFIED SERVICE PERSONNEL.**

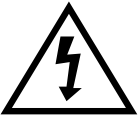

The lightning flash with arrowhead symbol, within an equilateral triangle, is intended to alert the user to the presence of uninsulated "dangerous voltage" within the product's enclosure that may be of sufficient magnitude to constitute a risk electric shock.



The exclamation point within an equilateral triangle is intended to alert the user to the presence of important operating and servicing instructions in the literature accompanying the appliance.

WARNING: To reduce the risk of fire or electric shock hazard, do not expose this appliance to rain or moisture.

Safety Precautions

1. CLEANING

Unplug this TV equipment from the AC power outlet before cleaning. Do not use liquid cleaner or aerosol cleaners. Use a soft and damp cloth for cleaning.



2. ATTACHMENTS

Do not use attachments not recommended by the TV equipment manufacturer as they may result in the risk of fire, electric shock or other injury.



3. WATER AND MOISTURE

Do not place this TV equipment near water, for example, near bathtub, kitchen sink, laundry tub, in a wet basement, or near a swimming pool, or the like.



4. HEAT

Keep the TV equipment away from the heat sources such as radiator, heater, stoves and other heat-generating products.

5. SETTING

Do not place this TV on unstable cart, stand, or table. Placing the TV on an unstable base can cause the TV to fall, resulting in serious personal injuries as well as damage to the TV. Use only a cart, stand, bracket or table recommended by the manufacturer or salesperson.



6. WALL OR CEILING MOUNTING

When mounting the product on a wall or ceiling, be sure to install the product using the designated mounting tool according to the method recommended by the manufacturer.



7. POWER

This TV equipment should be operated only from the type of power source indicated on the marking label. If you are not sure of the type of power supplied to your home, consult your TV dealer or local power company.



8. PIXEL

The LCD panel is a very high technology product with 2,359,296(15") 2,949,120(17") 1,440,000(20") thin film transistors which give you fine picture details. Occasionally, a few non-active pixels may appear on the screen as a fixed point of blue, green or red please note that this does not affect the performance of your product.

9. SET MOVING

When moving the product, place your fingers of one hand in the socket on the back of the CTV and support the front of the TV with the other hand.

Contents

IMPORTANT SAFEGUARDS	5
SUPPLIED ACCESSORIES	6
FUNCTIONAL OVERVIEW	7
Front (Control panel)	7
Remote controller	8
PREPARATION	9
Inserting Batteries into the Remote Control Unit	9
Mains connection	9
Aerial connection	10
Connecting external equipment	12
INSTALLATION	14
Language selection	14
Automatic Tuning of TV Channels	14
Programme Editing	15
Manual Tuning	16
DAILY USE	18
Switching On and Off	18
Recall	18
Programme Selection	19
Picture Control	19
Sound Control	20
Special Features	21
Time setting	21
Wake up time setting	22
Sleep	22
Teletext (Option)	23
PC setup	25
WALL/ARM MOUNTING	27
TROUBLESHOOTING	28
PRODUCT SPECIFICATIONS	29

Important Safeguards

Location

Heat, Moisture, Dust, Vibration

Position your set so that bright light or sunlight doesn't fall directly onto the screen. Care should be taken not to expose the set to any unnecessary vibration, moisture, dust or heat.

Do not expose the set to dripping or splashing.

Ventilation

Also ensure that the set is placed in a position to allow a free flow of air.

Do not cover the ventilation openings on the back cover.

Leave at least 10 cm around each side of the TV set.

Mounting

This set can be positioned by using the table top stand or wall mounting bracket.

When you install the set using the wall mounting bracket, fix it carefully so it is secure.

Object Entry

Do not insert foreign objects, such as needles and coins, into the ventilation openings.

Lightning striking

You should disconnect your set from the mains and the aerial system during thunderstorms.

Cleaning

Unplug the set from the mains before cleaning.

Dust the set by wiping the LCD screen and the cabinet with a soft, clean cloth.

If the screen requires additional cleaning, use a clean, damp cloth.

Do not use liquid cleaners or aerosol cleaners.

Do not rub or strike the LCD with anything hard as this may scratch, or damage the LCD permanently.

Service

Never remove the back cover of the set as this can expose you to high voltage and other hazards.

If the set does not operate properly, unplug it and call your dealer.

Supplied Accessories

Make sure that the following accessories are provided with the product.

AC cord

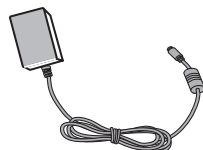

AC/DC adapter



Remote controller

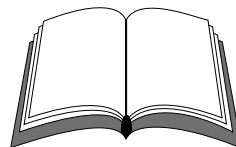

Instruction manual

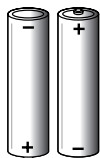

Batteries (Option)
(2x1.5V, AAA)

Functional Overview

Front (Control panel)

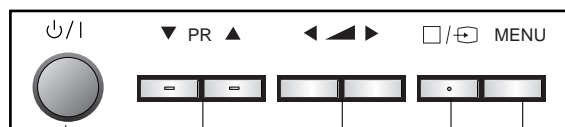
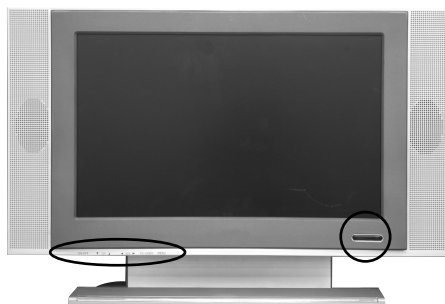

Power
On/Off

PR
Up/Down

Volume
Up/Down

AV MENU



Remote
sensor

LED
indicator

Functional Overview

Remote Controller

[] : Teletext function

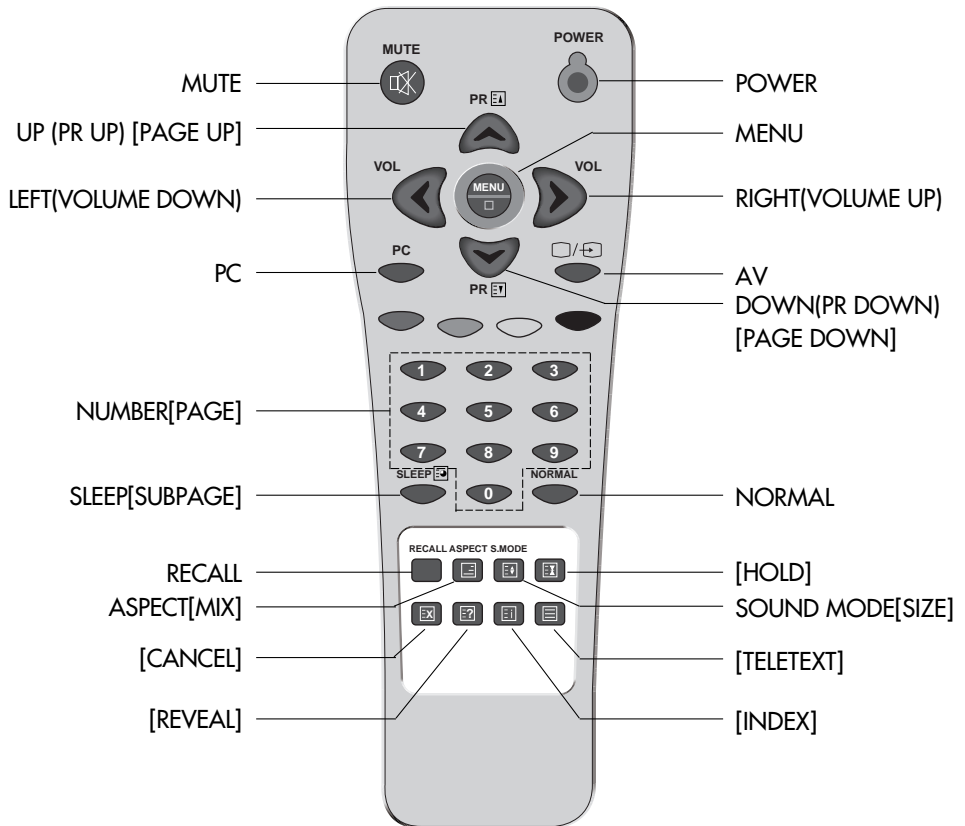

Preparation

Inserting Batteries into the Remote Control Unit

To load the batteries, turn the remote control handset over and open the battery compartment. Insert the batteries (Two 1.5v, type R03 or AAA). Make sure that the polarity matches with the (+) and (-) marks inside of the battery compartment.

Note: To avoid damage from possible battery leakage, remove the batteries if you do not plan to use the remote control handset for an extended period of time.

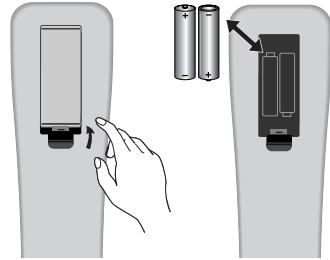

Mains Connection

1. Connect the DC plug of the AC adaptor to the **DC 12V(DC 15V-only 20")** input terminal of the set.
2. Connect the AC adaptor and AC cord.
3. Plug the other end of AC cord into a Power outlet with **100V - 240V ~, 50/60Hz.**

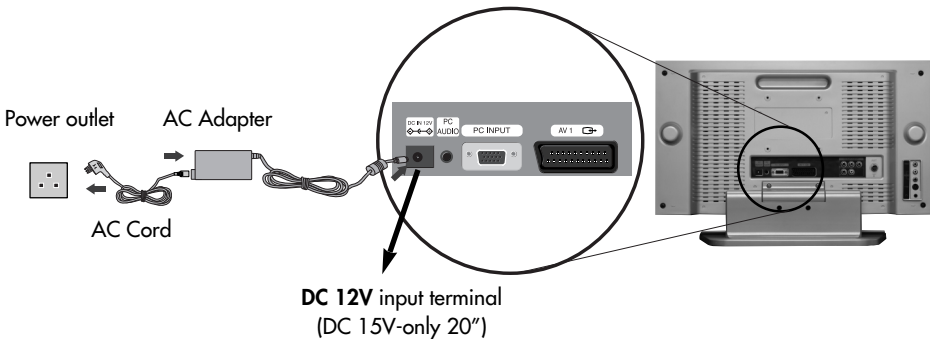

Preparation

Aerial Connection

CONNECTING THE TV DIRECTLY TO AN AERIAL

Connect an aerial cable (75 ohm coaxial cable) to the **Aerial terminal** on the back of the TV set.

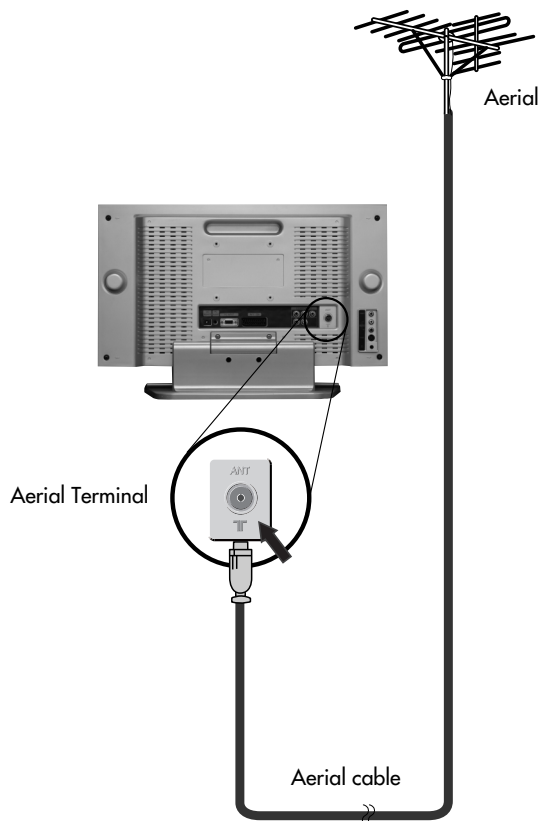

Preparation

AERIAL CONNECTION WITH VCR

Connect your ① aerial cable to the RF(aerial) IN terminal on the VCR.

Connect the RF OUT terminal of the VCR to the Aerial terminal on the TV set with ② RF cable.

NOTE: If you wish to use only the Aerial (RF) connection, then you should store the VCR channel on programme number **"ZERO"** using the **"Manual tuning"** function (See page 16). Now you can watch the VCR in TV mode by selecting the programme number **"PROO"**.

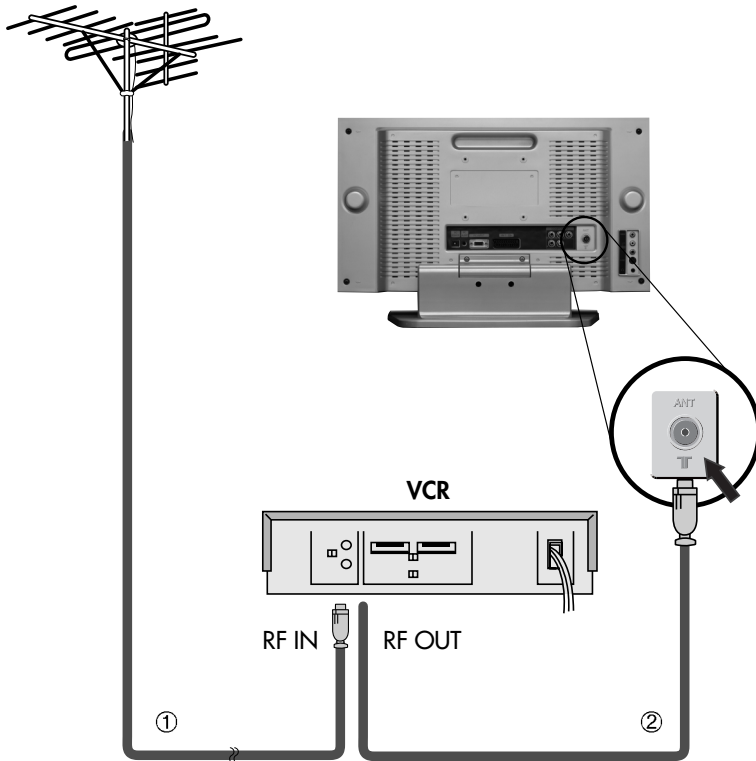



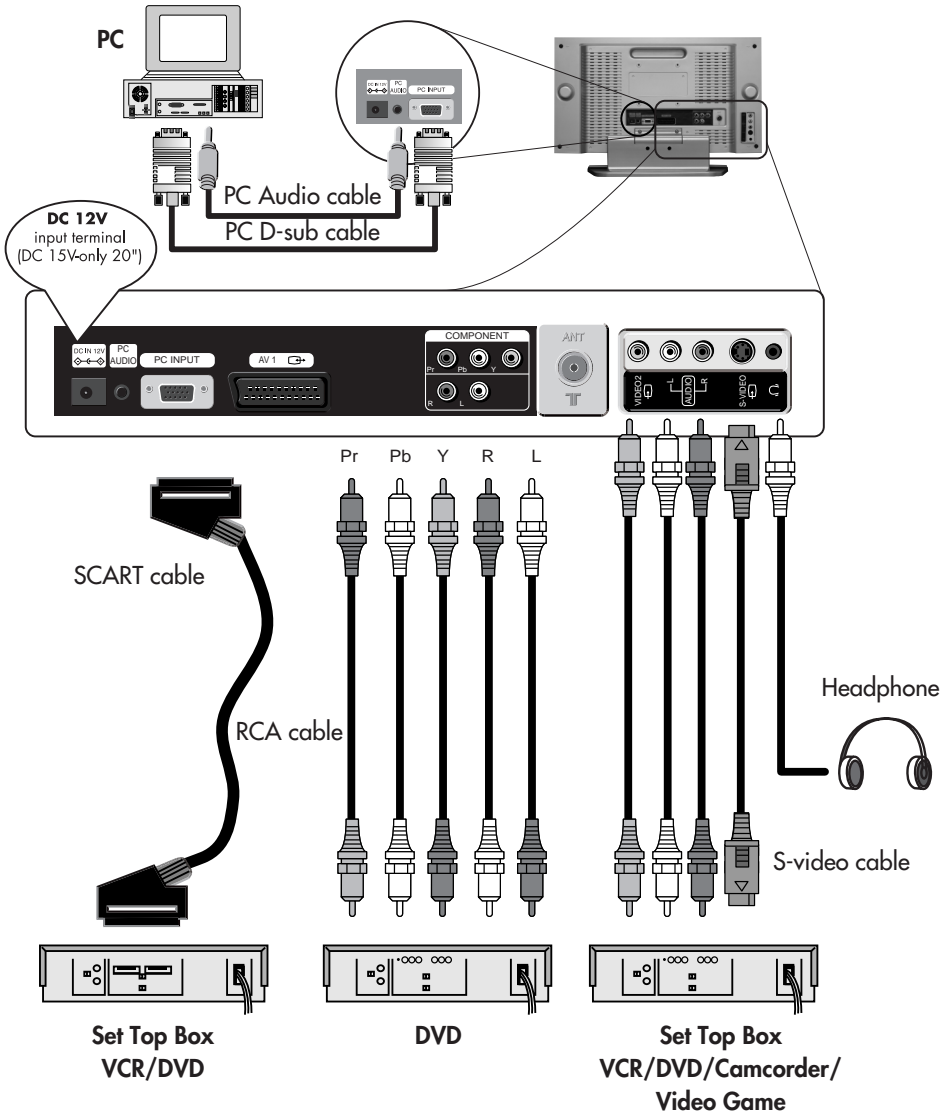

Preparation

Connecting external equipment



Preparation

TV/AV/PC MODE SELECTION

Press the TV/AV( / ) button on the control panel repeatedly to select the source. You can also select the source using TV/AV( / ) button on the remote controller.

TV → **AV1** → **AV2** → **S-VIDEO** → **COMPONENT** → **PC** → **TV**

There is the direct key on the remote controller, PC, for the PC mode.

In TV mode, you can change the TV programme number with the **▼PR▲** button or the **NUMBER** button.

NOTE : When the TV SET has no signal, OSD(On Screen Display) appears on the screen.

AV INPUT JACK (VIDEO2)

This jack has video / audio inputs.

It is used to connect a VCR, Camcorder, DVD, STB, Video game.

S-VIDEO INPUT JACK

It has Y/C inputs. This jack is used to connect S-Video equipment.

COMPONENT INPUT JACK (COMPONENT)

This jack has Y/Pb(Cb)/Pr(Cr) inputs and audio inputs.

It is used to connect a DVD.

SCART JACK (AV1)

This jack has video / audio inputs and outputs, RGB inputs.

It is used to connect a STB, VCR, DVD.

When the signal is RGB, the TV set switches automatically to AV1 mode.

In most cases, the TV set switches automatically to AV1 mode, when the external equipment is connected in playback mode. If not, then use the **AV** button to select **AV1**.

HEADPHONE JACK

Insert the headphone plug(3.5 mm ø) into this jack( ,).

The sound from the speaker will be automatically cut off.

You can control the headphone sound with the **◀VOL▶** button.

D-SUB JACK (PC RGB)

This jack has RGB inputs and is used to connect a PC.

See page 25 for more information of PC mode.

PC AUDIO INPUT JACK

Connect the stereo audio cable to the **PC AUDIO** jack and the other end to the Audio Out terminal of the Sound card on your PC.

Installation

Language Selection

1. When you turn on the TV set(see page18) for the first time, the **Language** menu appears for the on-screen display.

If not,

- (1) Press the **MENU** button to call up the menu.
 - (2) Move the selection bar to the **Utilities** menu with **▼PR ▲** button.
 - (3) Press the **VOL ►** button.
 - (4) Move the selection bar to the **Language** with **▼PR ▲** button.
2. Press the **◀VOL ►** button to choose the language you want .
 3. Press the **MENU** button to escape from menu.

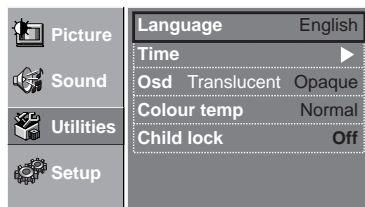

Automatic Tuning of TV Channels

1. Press the **MENU** button to call up the menu.
2. Move the selection bar to the **Setup** menu with **▼PR ▲** button.
3. Press the **VOL ►** button.
4. Place the selection bar on **Auto setup** and press the **VOL ►** button.
5. Place the selection bar on the Country you require with **▼PR ▲** button.

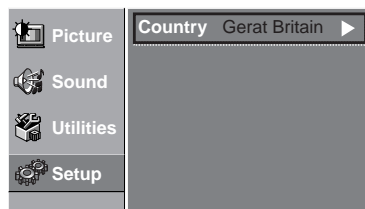
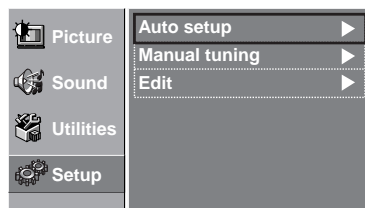

Installation

6. Press the **◀VOL▶** button. All available TV channels(CH) are searched for and stored from programme number (PR) 1 onwards automatically. The names of the TV channels are stored as well if the TV channels broadcast VPS, PDC or Teletext.
7. Please wait until the tuning screen disappears.



Programme Editing

Select the **Edit** menu from the **Setup** menu.

DELETING THE PROGRAMME

1. Position the selection bar to the programme to delete with the **▼PR▲** buttons.
2. Press the **YELLOW** button. The selected TV channel is deleted, all the following channels are shifted up one position.

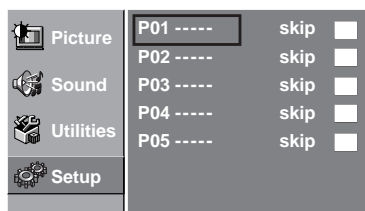

MOVING THE PROGRAMME

1. Select the programme to move with **▼PR▲** button.
2. Press **GREEN** button to move the selected programme up or down to the desired programme number.



SKIPPING THE PROGRAMMES

1. Select **Skip** "Yes" or "No" with the **RED** button.
2. The programme marked with **Skip** "Yes" doesn't appear on screen when selecting a programme using the **▼PR▲** button.

Installation

Manual tuning

Select the **Manual tuning** from the Setup menu.

PROGRAMME NUMBER SELECTION

1. Position a selection bar to **Program**.
2. Press the **◀VOL▶** buttons to select a programme number you want.

TV SYSTEM SELECTION

If necessary, you can change the TV System.

1. Position a selection bar to **System**.
2. Select the TV system with **◀VOL▶** button.

CHANNEL SEARCH

▼PR▲ Search

1. Position the selection bar to **Search**.
2. Press the **VOL▶** or **◀VOL** button to search up or down.
3. Searching will be stopped automatically after finding the next channel.
4. Without memorizing the searched channel, it will not be stored.

For saving the channel, position the selection bar to **Memorize**.

5. Press the **VOL▶** button.

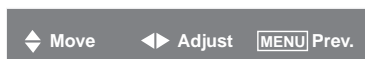
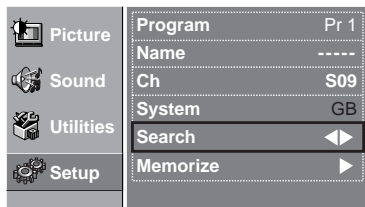
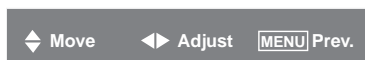
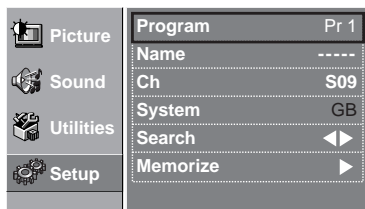

Installation

Direct Search

You can find the desired channel directly without **Search** function by inputting the channel number.

1. Place the selection bar to 'Ch'.
2. Press the **VOL ▶** button of the remote control to start.
3. Using **◀VOL▶** button of the remote control to select the digit, which you desire to change.
4. By pressing the **▼PR▲** button, you can find the desired number or character.
5. For saving the channel you select, please memorize it.

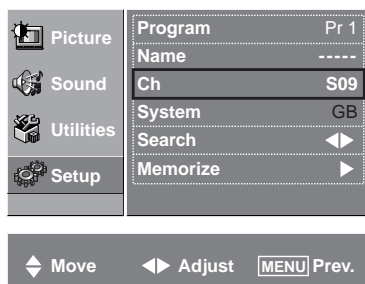

ENTER A STATION NAME

You can change an existing name, or enter a name where none exists.

1. Move the selection bar to **Name**.
2. Press the **VOL ▶** buttons to call up the **Name** menu.
3. Select the position with **◀VOL▶** button.
4. Use the **▼PR▲** buttons to select the desired character :
B C ... Z + - .(blank) 1 2 ... 9

A

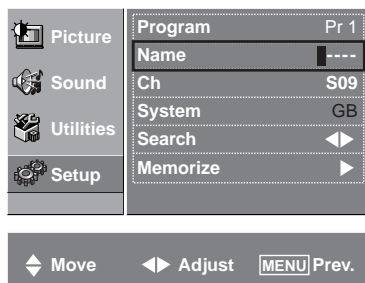

Daily Use

Switching On and Off

SWITCHING ON

1. If the Indicator is not lit, then the TV set is powered off.
You must press the  button on the TV set.
The set will switch to stand-by mode and then the Indicator will illuminate in Red.
2. Press the **POWER** button, **▼PR ▲** button or **NUMBER** button on the remote controller or **▼PR ▲** button on the TV set.
The TV set will be switched on and then the Indicator will change to Green.

SWITCHING OFF

1. Press the **POWER** button on the remote controller to return the set to its stand-by mode.
The Indicator will illuminate in Red.
2. Press the  button on the TV set to switch the TV set off completely.

NOTE: If you don't use the set for extended periods of time, unplug the AC cord from Power outlet.

Recall

The **Recall** button is used to display the current status; Mode (AV, Component, PC) and Signal information for 4 seconds.

In TV mode, the Programme number and Station Name, Sound mode are displayed.

Daily Use

Programme Selection

The set has 100 programme numbers, PR00..PR99.

DIRECT SELECTION

The **NUMBER** buttons are used for direct programme selection.

To select a two-digit programme, press the second numbered button within 2 seconds.

▼PR▲ SELECTION

You can also select a programme by pressing step by step the ▼PR▲ buttons.

Picture Control

1. Select the **Picture** menu.
2. Select and adjust the level of each function:
"Brightness", "Contrast", "Colour", "Sharpness".

The adjusted levels are stored automatically in Favourite mode.

NOTE: **Tint** is displayed only when receiving a NTSC signal. Only **Brightness**, **Sharpness** and **Contrast** are displayed in PC mode.

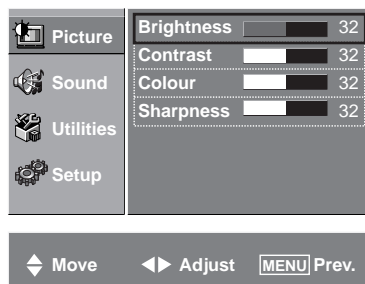

SMART NORMAL SELECTION

When you press the **NORMAL** button repeatedly, you can call up three pictures settings;

Normal1 → **Normal2** → **Favourite**
→ **Normal1**

ZOOM (ASPECT RATIO) CONTROL

You can select the desired aspect ratio with the **ASPECT** button on the remote controller.

(NB: It doesn't work in Component or PC mode.)

The following picture formats are available:

Normal → **16:9** → **Zoom (15"/20")**

Normal → **4:3** → **Zoom (17")**

Daily Use

Sound Control

VOLUME CONTROL

Adjust the volume with the ◀VOL▶ buttons.

MUTE

Pressing the **MUTE** button (⏏) turns the sound off.

The **MUTE** symbol will be displayed.

The sound returns if the button is pressed once more.

SOUND MODE

Stereo/Mono sound selection

When receiving a Stereo programme, **Stereo** mode is automatically selected.

In Stereo reception if you are unable to get good sound quality due to poor reception, you can force a change from Stereo to Mono transmission by pressing the **S.MODE** button.

Then the program status display indicates (Mono).

To return back to Stereo, press the **S. MODE** button again.

The setting can be individually selected for each PR number.

Volume  20

Pr 12
Stereo

Pr 12
Mono

Daily Use

Special Features

Select the **Utilities** menu.

CHILD LOCK

The set is child-locked by selecting "On". This prevents the use of the TV set without the remote control.

NOTE : When a Child lock is activated, the LED will be blinking the red and green in Stand-By mode.

OSD BACKGROUND

If you select **Translucent**, the OSD (On-Screen Display) back-ground appears translucent. If you select **Opaque**, the OSD back-ground appears opaque.

COLOUR TEMPERATURE CONTROL

You can change the tone of colour.

Normal: Normal white

Warm : Reddish white

Cool: Bluish white

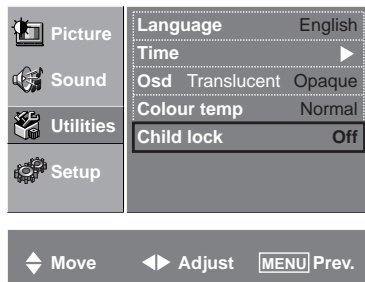

Time setting

1. Select **Time** from the **Utilities** menu.
2. Press the **VOL ▶** button while the selection bar is on **Time**.
3. Using **▼PR ▲** and **◀VOL ▶** buttons input the current time.
4. Press the **MENU** button for exit.

NOTE : Even though you turn off LCD unit with remote control, the time setting will be saved. However, if you turn off the main power off from the LCD unit the time setting will be reset.

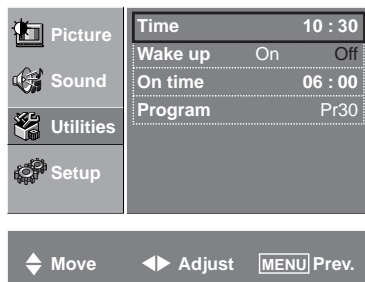

Daily Use

Wake up time Setting

Wake up

1. Select the **Wake up**.
2. Press the **VOL ▶** button while the selection bar is on **Wake up**.
3. Select wake up **On** or **Off** with the **◀VOL▶** buttons.
4. Press the **MENU** button for exit.

On time

1. Select the **On time**.
2. Press the **VOL ▶** button while the selection bar is on **On time**.
3. Using **▼PR▲** and **◀VOL▶** buttons, input the desired time.
4. Press the **MENU** button for exit.

Program

1. Select the **Program**.
2. Press the **VOL ▶** button while the selection bar is on **Program**.
3. Select the desired program for **Wake up** program with **◀VOL▶** buttons.
4. Press the **MENU** button for exit.

NOTE : The "Current time" must be set up before setting up other time memories.

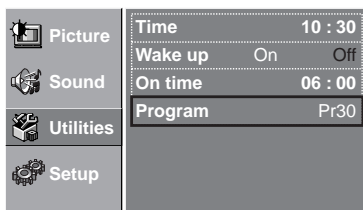
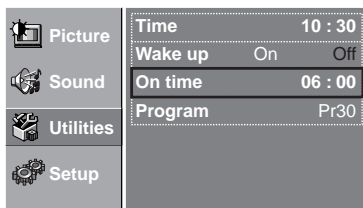
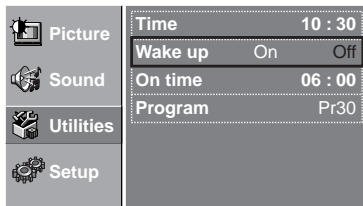

Sleep

By pressing the **SLEEP** button repeatedly, you can select one of the following settings:

Sleep 0 → Sleep 15 → Sleep 30 → Sleep 60 → Sleep 120 → Sleep 0

The set will turn off after the time you select.

NOTE: If a broadcast signal is not present for about 30 minutes, the set will be automatically turn to stand-by mode.

Teletext (Option)

SWITCHING TELETEXT ON/OFF

Press the **TELETEXT** button ().

The index page or the page viewed last will appear.

Press the **TELETEXT** button again to return to the TV mode.

NOTE: Teletext works only in TV/AV mode.

COLOUR BUTTONS IN TOP/FLOF TELETEXT

A red, green, yellow and blue field is shown at the bottom of the screen.

If TOP or FLOF Teletext is transmitted by the station, pressing the corresponding colour button **R,G,Y,C** on the remote controller, enables you to select the desired page easily.

SELECTING PAGES

The **NUMBER** buttons are used to enter a page number.

The selected page number appears at the top of the screen and the page appears after a short time.

The **▼PR ▲** buttons increase or decrease the current page number by 1.

INDEX PAGE

You can switch directly to the programme preview(with TOP text) or the overview page of the station you are currently viewing by pressing the **INDEX** button ().

PAGE HOLD

Several sub pages can be combined under a page number and are scrolled at an interval determined by the television station. The presence of sub pages is indicated by, for example, 3/6 beneath the time, which means that you are looking at the 3rd page of a total of 6 pages.

If you want to look at a subpage for a longer period of time, press the **HOLD** button ().

The **HOLD** symbol appears and the contents of the subpage shown are kept on the screen and no longer updated or switched to other subpages.

Pressing the **HOLD** button again, the current subpage appears.

Daily Use

CALLING UP SUBPAGE DIRECTLY

Pressing the SUBPAGE button (), " - - - - " appears.

Enter the subpage number that you want to call up with the **NUMBER** button, for example, the 2nd page, sequence 0002.

The desired subpage will eventually be displayed on the screen and holds it there.

Meanwhile whilst you are waiting, it is possible to go back to the TV picture by pressing the **CANCEL** button() on the remote and after a while, press the **CANCEL** button again to revert back to the saved Teletext sub page.

WATCHING TV DURING TELETEXT MODE

Some pages are continually updated, for example, stock market reports, sports announcements, and the latest news.

If you want to watch television and stay informed at the same time, press **CANCEL** button ().

The regular programme is still visible and the Teletext page number appears at the top of the screen.

Pressing the **CANCEL** button, the Teletext page appears with the updated information.

REVEAL ANSWER

This function can be used on certain pages to reveal the solution of riddles.

Press the **REVEAL** button () to reveal a hidden answer and press again to hide it.

DOUBLING CHARACTER SIZE

Repeatedly pressing the **SIZE** button () doubles the character size in the following order:

Upper half of the page → **Lower half of the page** → **Normal size**

→ **Upper half of the page**

MIX

By pressing the **MIX** button (), the teletext pages will be superimposed on the TV picture.

Press the **MIX** button again to return back to teletext pages.

Daily Use

PC setup

PC Mode input format.

If the signal from the PC system equals one of the standard signal modes, the screen will automatically adjust and display image. If the signal from the PC system doesn't equal any of the modes, adjust the Video card setting on the computer. For the display modes listed below, the screen image has been optimized during manufacture. The message "Out Of Range" will appear when the PC signal does not correspond to any of the below standard setting

Standard	Resolution(Mode)	V-frequency(Hz)	H-frequency(KHz)	15"	17"	20"
MAC	640x480	66	35.00	○	○	○
	832x624	75	49.73	○	○	○
IBM	640x480	60	31.47	○	○	○
	720x400	70	31.47	○	○	○
VESA	640x480(VGA)	72	37.86	○	○	○
	800x600(SVGA)	60	37.88	○	○	○
		72	48.08	○	○	○
	1024x768(XGA)	60	48.37	○	○	X
		70	56.48	○	○	X
	1280x768(WXGA)	60	47.70	X	○	X

Please up-grade the video card driver with the latest version because some of old version video cards may not support the 1280x768 resolution.

Daily Use

Select the **Screen** menu in the **PC** mode.

H-POSITION AND V-POSITION

Use this to adjust the horizontal and vertical position of the displayed image.

PHASE

This function allows you to remove any horizontal noise and clear or sharpen the image of characters.

FREQUENCY

This function is to minimize any vertical bars or stripes visible on the screen background. And the horizontal screen size will also change.

AUTO SETUP

This function is for the automatic adjustment of the screen **POSITION**, **PHASE** and **FREQUENCY**.

NOTE: Some signal from some Video cards may not function properly. If the results are unsatisfactory, adjust **POSITION**, **PHASE** and **FREQUENCY** manually.

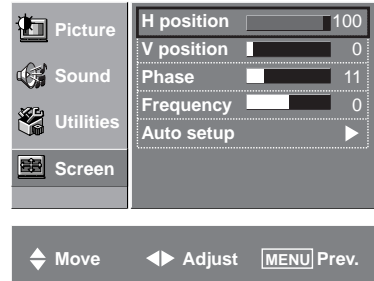

Wall/Arm Mounting

Attaching a Wall or Arm mounting device

This TV supports the VESA mounting standard and will accommodate various VESA mounting devices.

To install any VESA mounting device, please follow the manufacturer's instructions.

1. Remove all cables connected to the TV.
2. Lay the LCD TV face-down on a flat surface with a blanket or other soft materials to protect the screen.
3. Remove the four screws attaching the stand. Remove stand from LCD TV.
4. Remove the four screws attaching the rear cover.
5. Now you are ready to install the VESA mounting device suited to your applications (see instructions below).
6. Connect all cables removed at step 1.

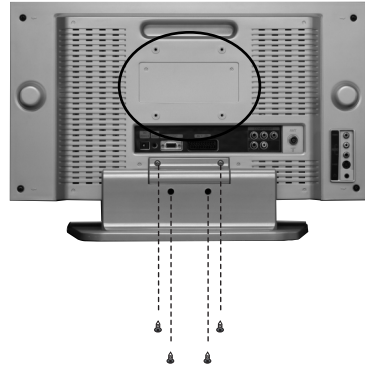

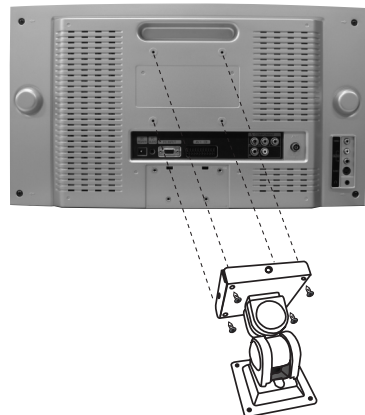

Installing VESA compliant mounting devices

1. Align the mounting interface pad (100mm x 100mm hole spacing) with the holes in the television's rear cover mounting pad.
2. Secure bracket with the four screws (4mmØ) that came with the VESA mounting device.



Troubleshooting

Please check the following items before calling for the repair services.

Problem	Check item	Reference page
TV set		
Control/System lock up	<ul style="list-style-type: none"> The TV may have malfunctioned. Switch your TV off and on again with the main  button on the TV set. 	<ul style="list-style-type: none"> - 18
Remote control does not work.	<ul style="list-style-type: none"> Perform control/system lock up reset (as above) Replace the batteries in the remote controller. Make sure the Remote sensor window is not under strong light e.g. a fluorescent lamps. 	<ul style="list-style-type: none"> 9 -
Local buttons do not work.	<ul style="list-style-type: none"> Has the Child lock been switched on? 	21
No picture and no sound.	<ul style="list-style-type: none"> Check that the TV set is switched on at the main  switch. 	18
No picture.	<ul style="list-style-type: none"> Make sure the brightness and contrast are not set to minimum. 	19
No colour	<ul style="list-style-type: none"> Make sure the Colour is not set to minimum. Check the System settings. 	<ul style="list-style-type: none"> 19 16
Picture is too light or too dark.	<ul style="list-style-type: none"> Adjust the Brightness, Contrast. 	19
The picture is improperly tinted.	<ul style="list-style-type: none"> Adjust the Colour temperature. Check the Tint adjustment (NTSC signal) 	<ul style="list-style-type: none"> 21 19
No sound.	<ul style="list-style-type: none"> Check that the volume is not set to minimum. Check sound is not muted. Make sure headphones are not connected. 	<ul style="list-style-type: none"> 20 20 13
Aerial		
The picture is not sharp. The picture shakes.	<ul style="list-style-type: none"> Reception may be weak. The quality of the broadcast may also be poor. Make sure the aerial is facing the correct direction. Check that the outside aerial is not disconnected. 	
The picture is ghosted.	<ul style="list-style-type: none"> Mountains or high buildings can cause double pictures. Try changing the direction of the aerial. 	
The picture is spotted(snow).	<ul style="list-style-type: none"> There may be interference from automobiles, trains, high voltage lines, neon lights, etc. There may be interference between the aerial cable and power cable. Try positioning cables further apart. 	
Picture has lines and faded colours.	<ul style="list-style-type: none"> Transmission aerial of amateur radios and cellular phones may cause interference. Position the TV set as far away as possible from devices that may cause interference. 	
PC		
Poor image	<ul style="list-style-type: none"> Adjust the Phase and Frequency. 	26
Image is not centered on screen	<ul style="list-style-type: none"> Adjust the Horizontal and vertical position. 	26

Product Specifications

MODEL NUMBER	DSL-15D3/15D4	DSL-17D3/17D4	DSL-20D3/20D4
PANEL	15" TFT LCD	17" WIDE TFT LCD	20" TFT LCD
SCREEN SIZE	381 mm	434.38mm	510.54mm
DISPLAY COLOR	16.2M	16.2M	16.7M
CONTRAST RATIO	400	450	500
PIXEL PITCH	0.297(H)x0.297(V)	0.2895(H)x0.2895(V)	0.51(H)x0.51(V)
ASPECT RATIO	4:3	16:9	4:3
POWER REQUIREMENT	AC 100V-240V~, 50/60Hz		
POWER CONSUMPTION	34W	40W	50W
SOUND OUTPUT	2.5W+2.5W	2.5W+2.5W	2.5W+2.5W
APPEARANCE(mm)	463x345x215	544x358x215	608x456x215
WEIGHT	6Kg	7Kg	11Kg
NUMBER OF PIXELS	1024x768	1280x768	800x600
RESOLUTION	1024x768(XGA)	1280x768(WXGA)	800x600(SVGA)
DC POWER	DC 12V	DC 12V	DC 15V
TERMINALS	AV IN : COMPOSITE VIDEO, S-VIDEO, AUDIO L/R		
	COMPONENT : Y, Pb(Cb), Pr(Cr) [480i, 480p, 576i, 576p, 720p(50Hz/60Hz), 1080i(50Hz/60Hz)] AUDIO L/R		
	HEADPHONE : 3.5mm STEREO MINI-JACK		
	PC IN : D-SUB 15PIN RGB IN, PC AUDIO IN		
	ANT. IN : COAX-TYPE		
RECEPTION CHANNEL	CCIR + CATV + HYPER Channel VHF-L : NZ1 ~ S7 (45.25MHz ~ 147.25MHz) VHF-H : S8 ~ S36 (154.25MHz ~ 423.25MHz) UHF : S37 ~ E69 (431.25MHz ~ 855.25MHz)		

♥ Owing to our policy of continuous improvement, specifications may change.