



**DVD Home Theater System
Operating Instruction Manual**

DVD5038

DVD Home Theater System



Manufactured under license from Dolby Laboratories. "Dolby", "Pro Logic" and the double-D symbol are trademarks of Dolby Laboratories. Confidential Unpublished Works. ©1992-1997 Dolby Laboratories, Inc. all rights reserved.



- Built-in Dolby Digital decoding for maximum home entertainment enjoyment
- Unique laser-head over-current protection system doubles service life
- Special DVD deck features fully dust proof and anti shock design as well as augmented error correction and better stability
- Fully functional DVD operating system offers many favorite functions and user-friendly operation
- Integrated DVD and built-in 6-channel Hi-Fi amplifier

TECHNICAL SPECIFICATIONS

DVD Player

TV System	NTSC/PAL
Compatible Discs	DVD, CD, MP3, CD-R, CD-RW
Resolution Ratio	Greater Than 500 lines
Video S/N Ratio	65dB
Frequency Response	fs (96KHz/24bit) 4Hz - 44KHz: +/- 2dB
Audio S/N Ratio	95dB
Degree of Distortion	<0.01%
D/A Converter	192KHz/24bit
Video Out	1Vp-p
S-Video Out	Y: 1Vp-p(75Ω) C: 0.3Vp-p(75Ω); 2.0V/±1V
Audio Out	5.1 Channel,
Digital Audio Output Connections	Coaxial YUV, CVBS S-Video, 2 Channel Output

FM Tuner

Tuning Range	87.5-108MHz
S/N Ratio	>46dB
Monophonic	>46dB
Stereo	>50dB (DIN)

Selectance	50dB
THD	
Monophonic	2%
Stereo	3%
Frequency Response	30Hz-10kHz +/- 1dB
Stereo Resolution	35dB (1kHz) 30dB (100Hz-10kHz)

AM Tuner

Tuning Range	530-1710KHz
S/N Ratio	35dB
THD	3%

Amplifier

Distortion Limited Output Power:	
Main Speakers	6W+6W (6Ω)
Surround Speakers	6W+6W (6Ω)
Center Speaker	6W (6Ω)
Subwoofer	40W (8Ω)

Frequency Response:

Main Speakers	200Hz-20kHz +/- 3dB
Surround Speakers	200Hz-20kHz +/- 3dB
Center Speaker	200Hz-20kHz +/- 3dB
Subwoofer	20Hz-200Hz +/- 3dB

S/N Ratio	> 76dB
Input Sensitivity	350mv, 47k
Channel Resolution	> 30dB (Normal)

Remote Control

Transmitter	Infrared Ray
Signal Range	Approximately 15'
Power Source	2 "AAA" Batteries

General

Power Supply	AC 120V~60Hz
Consumed Power	60W
Size (WxHxD)	420 mm x 50 mm x 348 mm

Because its products are subject to continuous improvement, We reserves the right to modify product design and/or specifications without notice and without incurring any obligations.

PRECAUTIONS

A lightning bolt with an arrowhead symbol within an equilateral triangle is intended to alert the user to the presence of uninsulated "dangerous voltage" within the product's enclosure that may be of sufficient magnitude to constitute a risk of electric shock to persons.



The exclamation point within an equilateral triangle is intended to alert the user to the presence of important operating and maintenance (servicing) instructions in the literature accompanying the appliance.



WARNING: TO AVOID THE DANGER OF FIRE OR ELECTRIC SHOCK, DO NOT EXPOSE THIS APPLIANCE TO RAIN OR MOISTURE. NEVER OPEN THE CABINET, AS DANGEROUS HIGH VOLTAGES ARE CONTAINED INSIDE. ONLY A QUALIFIED SERVICE TECHNICIAN SHOULD ATTEMPT TO OPEN THE CABINET.

CAUTION: TO PREVENT ELECTRIC SHOCK, MATCH WIDE BLADE OF PLUG TO WIDE SLOT, AND FULLY INSERT INTO ELECTRICAL SOCKET.

CAUTION: This DVD receiver unit employs a laser system. To prevent direct exposure to the laser beam, do not open the enclosure. Visible laser radiation is present when enclosure is open. DO NOT STARE INTO BEAM. Additionally, the use of controls or adjustments or performance of procedures other than those specified herein may result in hazardous radiation exposure.

To ensure proper use of this product, please read this owner's manual carefully and retain for future reference. Should the unit require maintenance, contact an authorized service centre.

FCC NOTICE: This equipment has been tested and found to comply with the limits for a Class B digital device, pursuant to section 15 of the FCC rules. These limits are designed to provide reasonable protection against harmful interference in a residential installation.

This equipment generates, uses, and can radiate radio frequency energy and, if not installed and used in accordance with the instructions, may cause harmful interference to radio communication. However, this is no guarantee that interference will not occur in a particular installation. If this equipment does cause harmful interference to radio or television reception, which can be determined by turning the equipment off and on, the user is encouraged to try to correct the interference by one of the following measures:

- Reorient or relocate the receiving antenna
- Increase the separation between the equipment and receiver
- Connect the equipment into an outlet on a circuit different from that to which the receiver is connected
- Consult the dealer or an experienced radio/TV technician for help

FCC Caution: Any changes or modifications not expressly approved by CURTIS Technology could void the user's authority to operate this equipment.

INDUSTRY CANADA REQUIREMENT

This Class B digital apparatus meets all requirements of the Canadian Interference-Causing Equipment Regulations.

PROTECT YOURSELF!

Record the model and serial numbers for this unit while it is easy to see them. These numbers are located on the back of the unit's cabinet. Retain this information for future reference.

Model Number DVD5038

Serial No. _____
Retain this information for future reference.



CAUTION
RISK OF ELECTRIC SHOCK DO NOT OPEN

CAUTION: TO REDUCE THE RISK OF ELECTRIC SHOCK, DO NOT REMOVE COVER (OR BACK). THERE IS NO USER SERVICEABLE PART INSIDE. REFER SERVICING TO QUALIFIED SERVICE PERSONNEL.

IMPORTANT-- SAFETY INFORMATION

CAUTION: Is it important that you read and follow all of the instructions in this booklet and any marked on the unit itself. Retain this booklet for future reference.

Accessories--- Never place this product on an unstable platform, stand, cart, wall mount, shelf, or table. The product may fall, causing serious personal injury to persons and pets, as well as seriously damaging the product. Use only with a stable platform, stand, cart, wall mount, shelf, or table that has been recommended by CURTIS or sold with the product.

Any mounting of the product should follow the manufacturer's instructions, and use a mounting accessory recommended by the manufacturer. This unit while positioned on some type of cart must be moved with care. Quick stops, excessive force, and uneven surfaces may cause the product and cart combination to overturn.

Attachments--- Use only approved attachment as they may cause hazards.

Cleaning--- Always unplug this unit from the wall electrical outlet before cleaning. Do not use liquid or aerosol cleaners; use a damp cloth for cleaning.

Lightning--- For added product protection during a lightning storm or when it is left unattended and unused for long periods of time, unplug it from the wall outlet and/or disconnect the antenna or cable system. This will prevent damage to the product due to lightning and power-line surges.

Object and Liquid Entry--- Never push objects of any kind into this product through openings as they may touch dangerous voltage points or short-out parts that could result in a fire or electric shock. Never spill liquid of any kind on or into the product.

Outdoor Antenna Grounding--- If an outside antenna or cable system is connected to the product, be sure the antenna or cable system is grounded so as to provide protection against voltage surges and built-up static charges.

Overloading--- Do not overload wall outlets, extension cords, or integral convenience receptacles, as this may result in a fire or electric shock.

Power - Cord Protection- Power- supply cords should be routed so that they are not likely to be walked on or pinched by items placed upon or against them, paying particular attention to cords at plugs, convenience receptacles, and the point where they exit from the product.

Power Lines--- An outside antenna system should not be located in the vicinity of overhead power lines or other electric light or power circuits, or where it can fall into such power lines or circuits. When installing an outside antenna system, extreme care should be taken to keep from touching such power lines or circuits as contact with them might be fatal.

Power Sources--- This product should be operated only from the type of power source indicated on the marking label. If you are not sure of the type of power supply to your home, consult your product dealer or local power company. For products intended to operate from battery power or other sources, refer to the operating instructions. This DVD home theater operates on AC 120V/60Hz. Do not turn off unit immediately after turning on; wait at least 10 seconds.

Replacement Parts--- If replacement parts are required, be sure the service technician has used approved replacement parts or have the same characteristics as the original part. Unauthorized substitutions may result in fire, electric shock, or other hazards.

Safety Check--- Upon completion of any service or repairs to this product, ask the service technician to perform safety checks to determine that the product is in proper operating condition.

Servicing--- Do not attempt to service this product yourself as opening or removing covers may expose you to dangerous voltage or other hazards. Refer all servicing to qualified service personnel.

TV System--- This unit is compatible with television sets featuring either the NTSC or PAL color system.

Ventilation--- Slots and openings in the cabinet are provided for ventilation and to ensure reliable operation and protection from overheating. These openings should never be blocked by placing the product on a bed, sofa, rug, or other similar surface. This product should not be placed in a built-in installation such as a bookcase or rack unless proper ventilation is provided. Never place this product near a heat source, such as heat registers, stoves, radiators, or any other product that produces heat.

Water and Moisture--- Do not use this product near sources of water and moisture, such as bath tub, wash bowl, kitchen sink, or wash machine; in a wet, damp basement; or near a swimming pool or similar locations. If moisture condensation occurs, remove any disc, connect the unit's power cord to a wall outlet, turn the unit on, and leave it on for two to three hours. By then, the unit will have warmed up and evaporated any moisture.

JPEG FILES

JPEG adopting the most efficient compression is widely used as picture storage type flattened and stored format.

Even if pictures are compressed 15-20 times. They still have good effect. Supported by most picture processing software, fit for picture storage, it has small data and easy use. This machine can read. JPEG-format-made picture CD disc.

Press relevant number key to select picture display.

1. Put in disc correctly, the machine begins to search disc information.
2. Press number key to select picture.
3. It's efficient only in present picture when press number key.

Select to play by menu

1. Put in disc, machine searches disc information and main menu displays on screen. Press number key from 1 to select picture. Press play key to make sure.
2. Press direction key to select picture then press play key.
3. In condition of stop. Press direction key to select other pictures.
4. In condition of stop. Select the first line file item on the right. Then press play key, to return to upper menu.

TROUBLE SHOOTING

This handy trouble-shooting guide is provided to save you time in case you experience any inconvenience with this DVD player. If the problem is not listed or if the provided solution does not correct the problem, please return to point of sale within 12 months of purchase.

Problem Possible Solution

No power

1. Check to ensure that the power plug is securely in the wall outlet.

No sound

1. Check the connection between the DVD player and the TV set, amplifier, or any other unit it is connected to.
2. Check to ensure the TV and amplifier are in the correct mode.

No picture

1. Check the connection between the DVD player and the TV set or any other unit it is connected to.
2. Check to make sure TV is turned on.

Disc does not play

1. Check to make sure the disc is loaded correctly label side facing up on disc tray.
2. Check that disc is clean from dirt, dust, fingerprints, and smudges.
3. Check to ensure disc is within the guides on the tray.
4. Check if parental lock function is on.
5. Make sure disc is for use in region.

Remote does not work.

1. Check batteries; possibly replace.
2. Check to ensure there isn't any obstacles between the remote sensor on the unit's front panel and the remote control.
3. Be sure the remote is aimed at the remote sensor.

Divided picture

1. Check that disc is clean and has no scratches.
2. The unit is controlled by a micro computer, which may need to be reset. Turn off the unit's power, wait several seconds, then turn back on.

No color picture

1. Check to see if the S connector is damaged (bent pin).

MP3 discs don't play

1. Use another software edition to re burn disc, as the edition used may not be compatible with the player.
2. Use new editions of software such as Audio station 4, "Easy CD Creator", To ast Titanium, etc.
3. Make sure MP3 file is not encoded with a variable bit rate, such as provided by Real Networks.

PASSWORD SETUP

Follow the operation instructions stated in "DVD menu setup" in combination with desired option in the following figure.

PASSWORD MODE SETUP

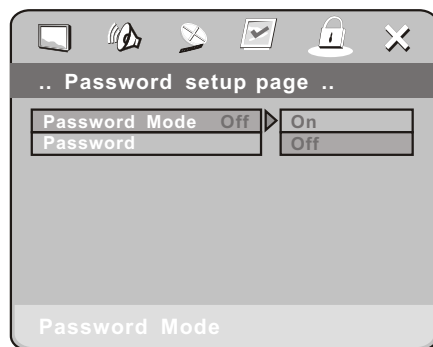

PASSWORD

The default is "0000" The user may change it using this option

Follow the operating instructions stated in "DVD menu setup" in combination with the desired option in the following figure.

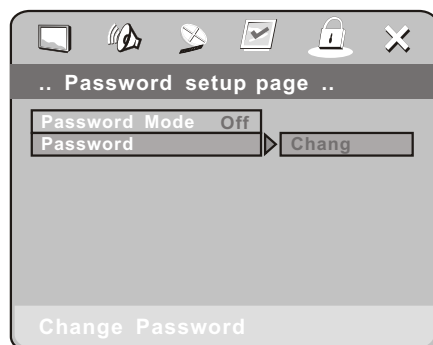

OPERATION OF MP3 FUNCTION

Mp3 is an audio compression mode using Level 3 of the international standard MPEG, whereby sound signal is compressed in a rate of 12:1. A Mp3 disc can record music for play of over 600 minutes or record over 170 songs, rivaling CDs in sound quality.

To play a MP3 disc

Files Menu of Mp3 play

When playing a Mp3 disc, 2 files menus can be selected by pressing PROG key: File list, Folder.

1. FILE LIST

It may select the files to be played by pressing UP DOWN arrow key combining with ENTER key, or using number keys and ENTER key to select directly. If the number input is out of the music number, "CURRENT TRACK NUMBER" will display on screen.

2. Folder

Display menu first then press up down, left right arrow and ENTER key to select subdirectory and music.

Precaution	1	System Setup.....	19
Safety Information	2	DVD Menu Setup	19
Table of Contents	3	General Setup	19
About Your DVD Player	4	Audio Setup	20
Best Location.....	4	Speaker Setup	20
To Obtain a Clear Picture.....	4	Spdif Setup	21
Playable Discs.....	4	Dolby Digital Setup	22
Digital Audio Output	4	3D Processing	22
Laser-Head Over-Current Protection System	4	Video Setup	22
Use of Disc	5	Preference Setup	25
Handling.....	5	Pass Word Setup	25
Cleaning.....	5	Mp3 function.....	26
Storing.....	5	JPEG files.....	27
Front and Back panels ..	6	Trouble shooting.....	27
Front Panel.....	6	Technical specifications	28
Back Panel.....	6		
Remote Control.....	7		
Operating the remote control.....	8		
Connecting Devices.....	9		
Speakers.....	10		
Arrangement of speakers.....	10		
Connecting speakers.....	11		
Connecting antenna.....	12		
Connecting power supply.....	13		
Playing the radio.....	14		
Basic DVD operation.....	15		
Functions.....	16		

ABOUT YOUR DVD PLAYER

The following will help you get the most enjoyment from your DVD receiver system.

BEST LOCATION

The unit should be placed on a firm, flat surface, away from VCRs, stereos, radios, or large speakers, as the magnetic flux from these devices may cause distortion in the sound and a poor picture. If placed in a cabinet, be sure there is at least "1" of free space completely around the unit for proper ventilation.

TO OBTAIN A CLEAR PICTURE

ADVD receiver is a precision device. If the optical pick-up lens and disc drive parts become dirty or worn down, picture quality will become poor. Store DVD player in a clean dust free environment.

PLAYABLE DISCS

This CURTIS DVD receiver system will play the following types of discs: DVD, MP3, CD, CD-R, and CD-RW with super-error correction ability. It is also capable of displaying picture CDs and digital photo albums. It supports eight languages, up to 32 subtitles, and multi-angle viewing. It features easy setup and operation with on-screen menus. It has full function CPU up grade able capability.

DIGITAL AUDIO OUTPUT

The unit's coaxial output capability enables you to connect an external six-channel AV amplifier and processor with built-in Dolby Digital code with just one cord. This enables you to conveniently enjoy different DVD, CD, and Mp3 discs.

ANALOG AUDIO OUTPUT

Speaker system plug-and-play convenience through the built-in six-channel power amplifier eliminates the use of an external power amplifier.

LASER-HEAD OVER-CURRENT PROTECTION SYSTEM

To extend the service life of the laser head, the unit includes a unique laser-head over-current protection system, ensuring a constant laser current.

4

SYSTEM SETUP

AUDIO LANGUAGE

Follow the operating instructions stated in "DVD MENU SETUP" in combination with the desired option in the following figure.

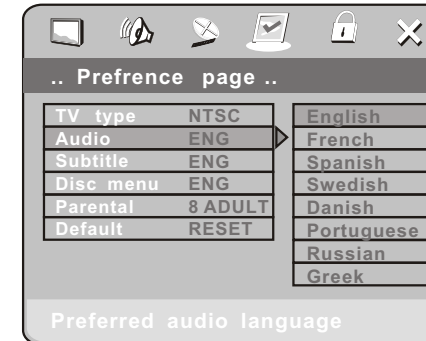

This machine provides English, French, Spanish, Swedish, Danish, Portuguese, Russian, Greek and Others as the built-in disc dubbing language options.

SUBTITLE

This machine provides English, French, Spanish, Chinese, Japanese, Korean, Russian, German and Others as the built-in subtitle languages. When a DVD is played, the user may hide the subtitle or choose any of them as the preset subtitle language.

Follow the operating instructions stated in "DVD MENU SETUP" in combination with the desired option in the following figure.

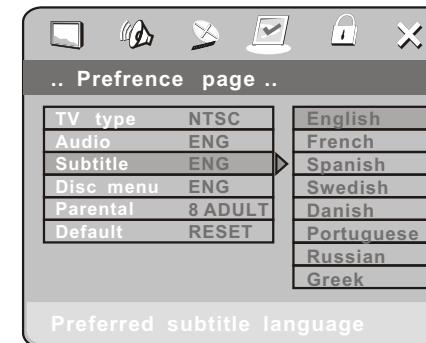

DISC MENU LANGUAGE

This machine provides English, French, Spanish, Swedish, Danish, Portuguese, Russian, Greek and others as the film's menu language options.

Follow the operating instructions stated in "DVD MENU SETUP" in combination with the desired option in the following figure.

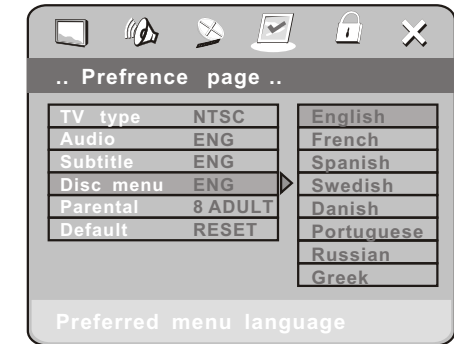

PARENTAL

Follow the operating instructions stated in "DVD MENU SETUP" in combination with the desired option in the following figure.

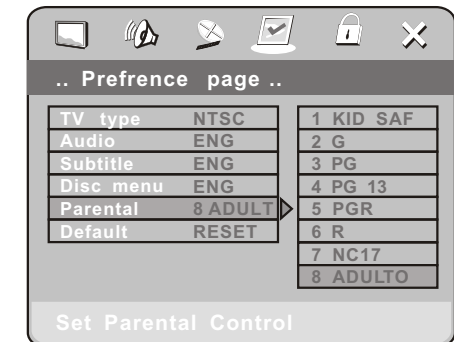

For a film to be restricted for children, the film class may be set according to label marking on the disc. High light "PARENTAL" in the preference setup menu need confirm the password mode is off.

DEFAULTS

This option will resume the original settings of this machine.

Follow the operating instructions stated in "DVD MENU SETUP" in combination with the desired option in the following figure.

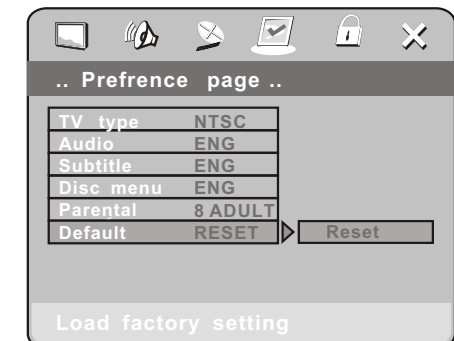

25

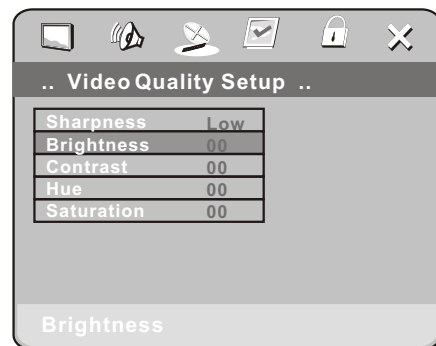

Press right arrow button to enter adjustment mode; press right and left buttons to make adjustment.

Press enter button to return to setup menu.

CONTRAST SETUP

Follow the operation instructions stated in "DVD menu setup" in combination with desired option in the following figure.

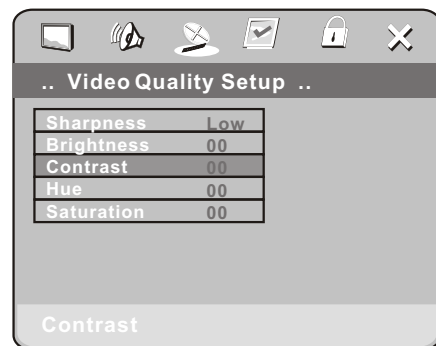

Press right arrow button to enter adjustment mode; press right and left buttons to make adjustment.

Press enter button to return to setup menu.

HUE SETUP

Follow the operation instructions stated in "DVD menu setup" in combination with desired option in the following figure.

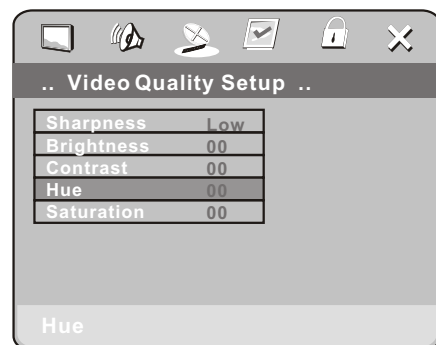

Press right arrow button to enter adjustment mode; press right and left buttons to make adjustment.

Press enter button to return to setup menu.

SATURATION SETUP

Follow the operation instructions stated in "DVD menu setup" in combination with desired option in the following figure.

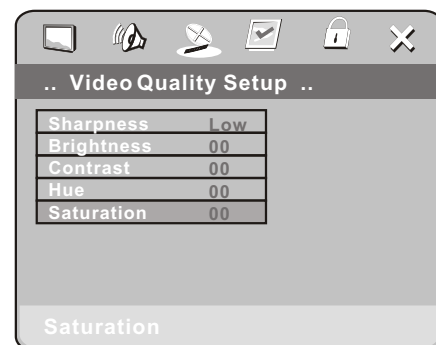

Press right arrow button to enter adjustment mode; press right and left buttons to make adjustment.

Press enter button to return to setup menu.

PREFERENCE SETUP

During stop mode, press the SETUP button to access the INITIAL SETUP menu, which includes items of dubbing language, subtitle, disc menu language, age control, default values and main menu.

Preset values are essential to a DVD player. The user may change these items as desired.

TV TYPE

Follow the operation instructions stated in "DVD menu setup" in combination with the desired option in the following figure.

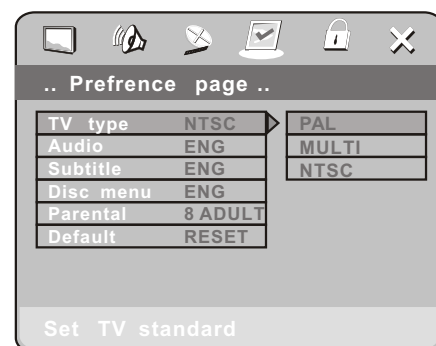

This product supports output of various system, including MULTI, NTSC, PAL.

1)If your TV set has only NTSC or PAL system, the screen will blink and become colourless when a wrong system is selected. In this case, press the N/P button on the R.C to return to normal, screen always remember to select the correct system.

2)For more information of output format, refer to the instructions or your TV set.

This page contains valuable information regarding the handling, cleaning, and storage of discs played in this unit.

Handling

- Do not touch the playback side of the disc.
- Do not attach paper or tape to discs.
- Do not stick or write anything on the surface. Protect against fingerprints.
- Always hold a disc by the center and edge portions.

Cleaning

- Fingerprints and dirt on the disc may cause picture and/or sound deterioration. Wipe the disc from the center outward with a soft cloth. Always keep the disc clean.
- If you cannot wipe the dirt off, lightly use a slightly moistened soft cloth and finish with a dry cloth.
- Do not use any type of solvent such as: Paint thinner, benzene, commercially available cleaners or anti-static spray for vinyl LPs.

Storing

- Do not store discs in places subject to direct sunlight or near heat sources.
- Do not store discs in places subject to moisture and dust.
- Store discs vertically in a case. Stacking or placing objects on discs outside of their case may cause warping.

NOTE: CURTIS is not responsible for damage that may occur to any disc that is operated in this unit or not handled, cleaned, or stored as suggested above.

FRONT AND BACK PANELS

Front Panel Functions

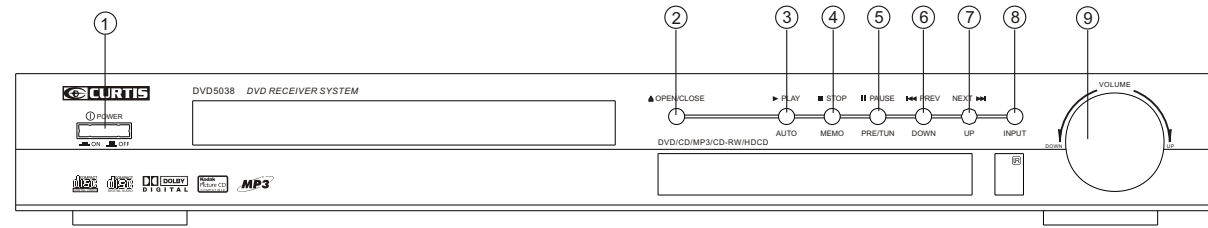

1. POWER

Before plugging the power cord into the AC outlet, check to make sure all of the connections have been properly completed. When they have been, carefully plug power cord into outlet.

Press the POWER button on the front panel to power the unit.

When the unit is initially powered, a brief surge of electricity may cause interference with other electronic equipment on the same circuit. If this occurs, connect the unit to an outlet on a different circuit.

2. ▲ OPEN/CLOSE

Use this button to open and close the disc tray while in DVD mode.

3. ▶ PLAY / AUTO

Use this button to begin play function while in DVD mode.

When in the tuner mode, you may press this button for automatic search..

4. ■ STOP/MEMO Button.

Use this button to stop play function while in DVD mode.

While in the tuner mode, this button is used to memory station.

5. || PAUSE/PRE/TUN

Use this button to pause play function while in DVD mode.

When in the Tuner mode, this button is used to select presetting or tuning mode.

6. ◀◀ PREV/DOWN

While in the DVD status, you may press this button for previous track.

While in the tuner mode, you may press this button for radio down search.

7. ▶▶ NEXT/UP

While in the DVD status, you may press this button for next track. .

While in the tuner mode, you may press this button for radio up search.

8. INPUT SIGNAL SOURCE

Use this button to select the proper input signal source. (Note: The selected input will correspond to the selected input terminal on the rear panel.)

9. VOLUME

Use this button to control the unit's volume. It controls all six channels simultaneously.

Back Panel Functions

1. ANTENNA

Use to connect the provided indoor FM and AM loop antennas.

2. AUX IN

Use to connect input for both auxiliary 1 and 2 music sources.

3. AUDIO OUT

Use to connect both the right and left channel line outputs as well as subwoofer output.

4. VIDEO OUTPUT

5. S-VIDEO OUTPUT

6. REAR

Use to connect the four terminals of the left and right surround sound speakers.

7. FRONT/MAIN

Use to connect the four terminals of the left and right front or main speakers.

8. CENTER/SUBWOOFER

Use to connect the four terminals of the center and subwoofer speakers.

9. COAXIAL DIGITAL AUDIO OUTPUT

10. 120V~60Hz

This unit comes with an AC power cord. Be sure its prongs are dry before plugging it into an electrical outlet. Take caution not to overextend the cord or walk on it.

11. COMPONENT VIDEO OUT

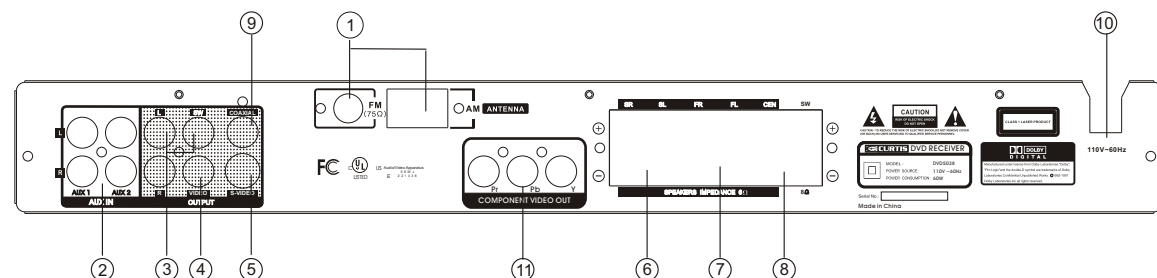

SYSTEM SETUP

MODE SETUP

Follow the operation instructions stated in "DVD menu setup" in combination with desired option in the following figure.

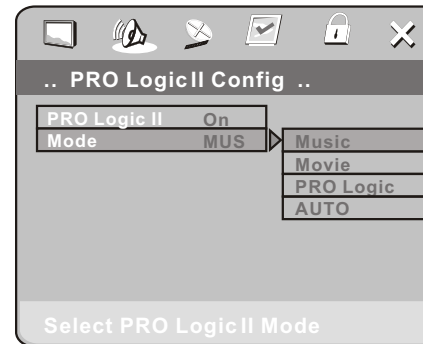

REVERB SETUP

Follow the operation instructions stated in "DVD menu setup" in combination with desired option in the following figure.

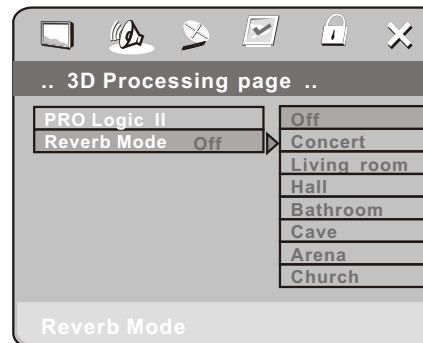

VIDEO SETUP

Includes component, TV mode and Quality setup.

COMPONENT SETUP

Follow the operation instructions stated in "DVD menu setup" in combination with desired option in the following figure.

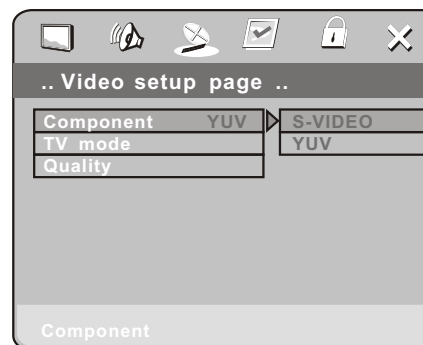

TV MODE SETUP

Follow the operation instructions stated in "DVD menu setup" in combination with desired option in the following figure.

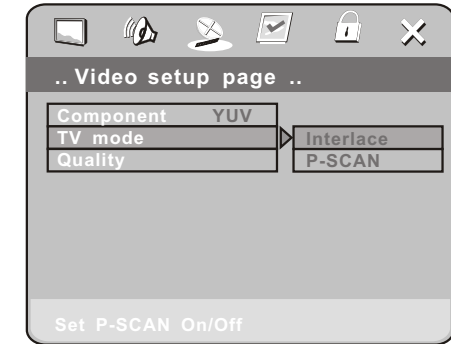

QUALITY SETUP

Include Sharpness, Brightness, Contrast, Hue, Saturation setup.

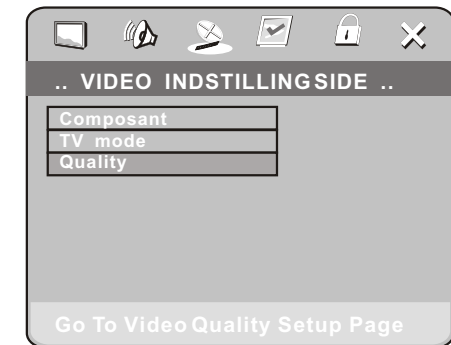

SHARPNESS SETUP

Follow the operation instructions stated in "DVD menu setup" in combination with desired option in the following figure.

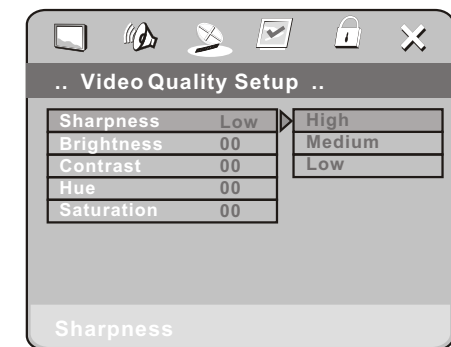

Press right arrow button to enter adjustment mode; press up and down buttons to make adjustment. Press left arrow button to return to setup menu.

BRIGHTNESS SETUP

Follow the operation instructions stated in "DVD menu setup" in combination with desired option in the following figure.

SYSTEM SETUP

If you have Dolby digital output in your amplifier/decoder, you may select stereo. Left, right and mixed sound accordingly.

DYNAMIC

Follow the operation instructions stated in "DVD menu setup" in combination with desired option in the following figure.

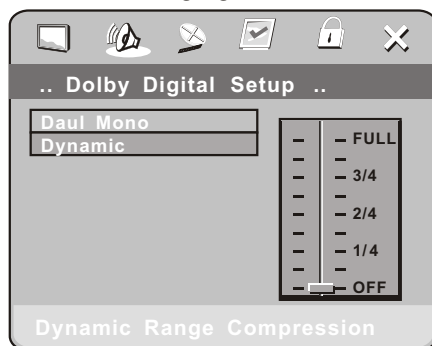

EQUALIZER SETUP

Include EQ Type, Bass Boost, Super Bass, Treble Boost setup.

Follow the operation instructions stated in "DVD menu setup" in combination with desired option in the following figure.

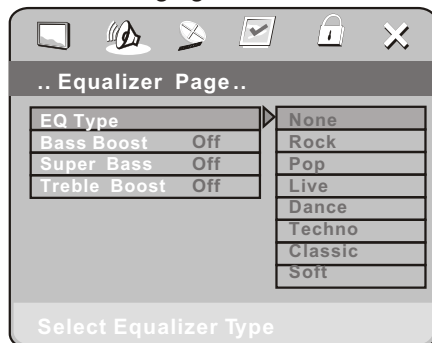

BASS BOOST SETUP

Follow the operation instructions stated in "DVD menu setup" in combination with desired option in the following figure.

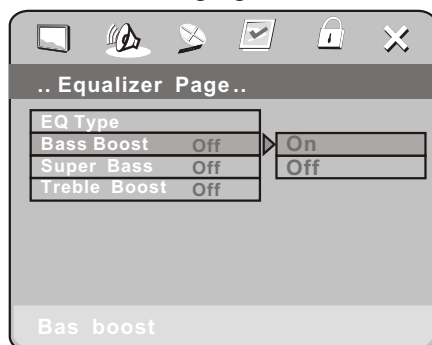

SUPER BASS SETUP

Follow the operation instructions stated in "DVD menu setup" in combination with desired option in the following figure.

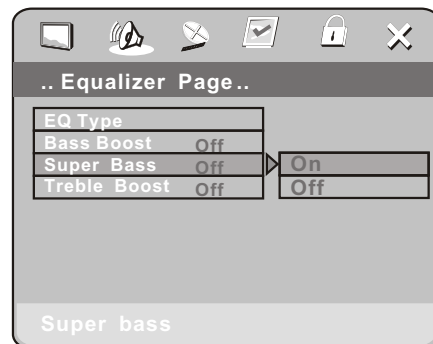

TREBLE BASS SETUP

Follow the operation instructions stated in "DVD menu setup" in combination with desired option in the following figure.

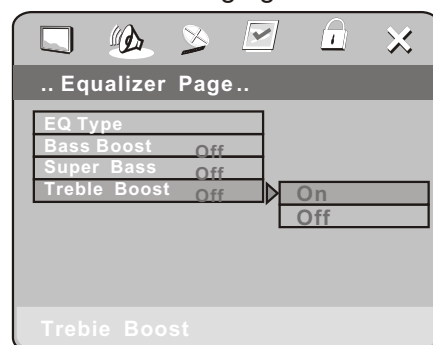

3D PROCESS SETUP

Includes PRO LOGIC II, reverb mode setup.

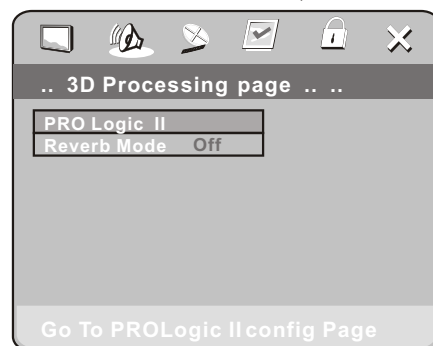

PRO-LOGIC II CONFIG

Includes prologic II, mode setup.

PRO-LOGIC SETUP

Follow the operation instructions stated in "DVD menu setup" in combination with desired option in the following figure.

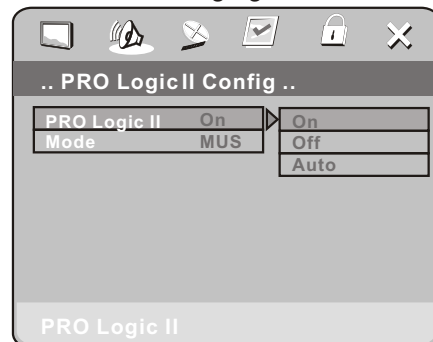

PRO LOGIC is set to ON, OFF or AUTO.

REMOTE CONTROLLER

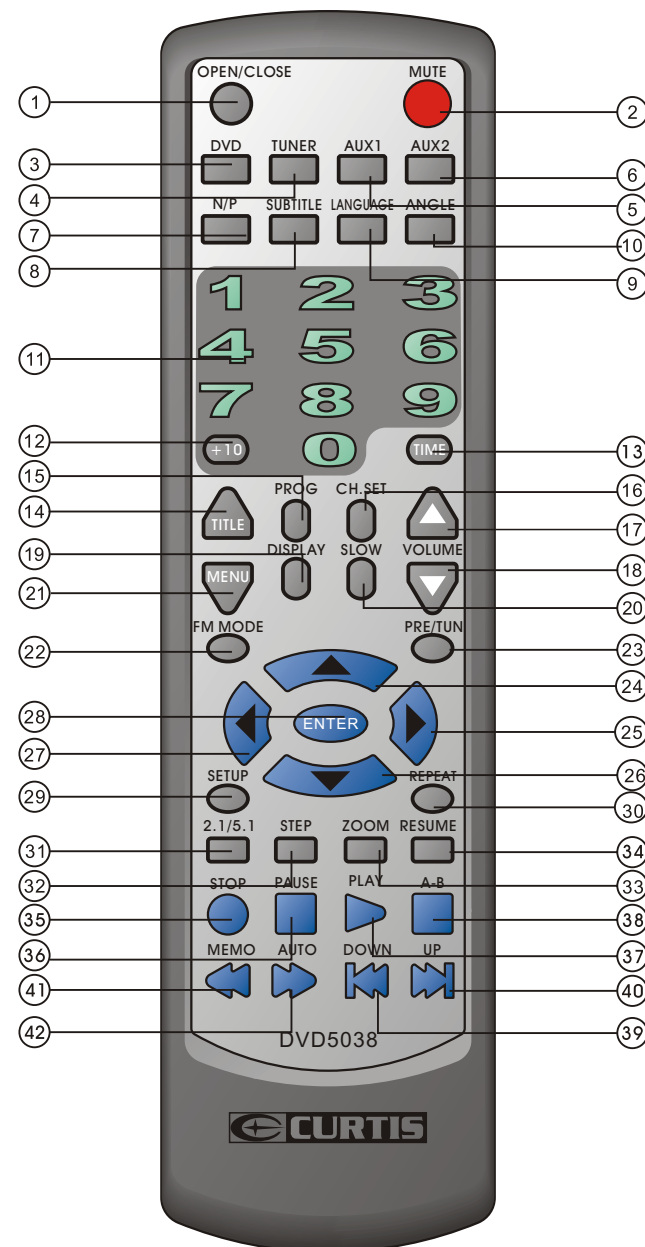

- ① OPEN/CLOSE
- ② MUTE
- ③ DVD SELECTOR
- ④ AM/FM TUNER
- ⑤ AUX1 SELECTOR
- ⑥ AUX2 SELECTOR
- ⑦ N/P TV MODE SELECTOR
- ⑧ SUBTITLE
- ⑨ LANGUAGE
- ⑩ ANGLE
- ⑪ 0-9 NUMBER KEYS
- ⑫ +10
- ⑬ TIME
- ⑭ TITLE
- ⑮ PROG PROGRAM
- ⑯ CHANNEL SELECTOR
- ⑰ VOLUME INCREASE
- ⑱ VOLUME DECREASE
- ⑲ SCREEN DISPLAY
- ⑳ SLOW MOTION
- ㉑ MENU
- ㉒ FM STEREO / MONO MODE
- ㉓ PRESET/TUNING
- ㉔ SCROLL UP
- ㉕ SCROLL RIGHT
- ㉖ SCROLL DOWN
- ㉗ SCROLL LEFT
- ㉘ ENTER
- ㉙ SETUP
- ㉚ REPEAT
- ㉛ 2.1/5.1 DOWNMIXING SELECTOR
- ㉜ STEP
- ㉝ ZOOM
- ㉞ RESUME PLAY
- ㉟ STOP
- ㊱ PAUSE
- ㊲ PLAY
- ㊳ A-B REPEAT
- ㊴ DOWN (search down for radio stations/ previous track)
- ㊵ UP (search up for radio stations/next track)
- ㊶ MEMO (memory/rewind skip)
- ㊷ AUTO (automatic search/forward skip)

FUNCTIONS

Time

This DVD receiver can display various data regarding the disc being played.

Press Time button the number of title and chapter, Audio, Subtitle language, Angle, Title time, Chapter time, repeat mode, display time.

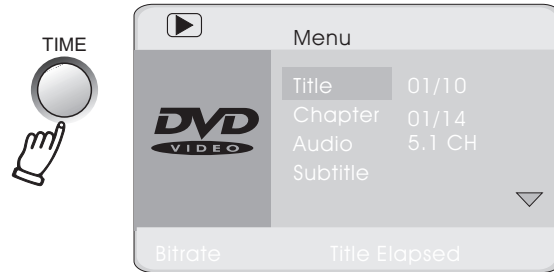

2. Press the A-B button again while the disc is playing to set point B, the ending spot. The section between A and B will replay.

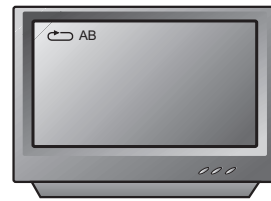

3. Press the A-B button a third time to cancel.



MENU: MENU/PBC

With the PBC function on, choosing a song on a CD can only be done when at the main menu. With the PBC function off, song selections can be made by entering the relevant number keys. The menu content of the disc will appear when the MENU button is pressed while a DVD disc is playing.



A-B Repeat

The A-B repeat function allows you to re-show sections between two specific points (A and B) on a disc.

1. Press the A-B button while the disc is playing to set point A, the beginning spot.

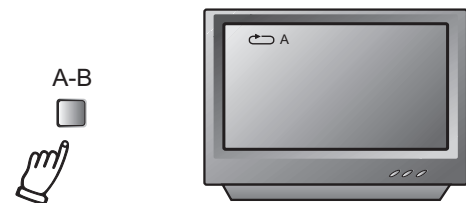

Repeat Play

This DVD receiver allows repeated playback of specific titles, chapters/tracks, or segment. It even allows switching between two items that are being repeated.

1. Select the item to repeat.
2. Press the REPEAT key.



The repeat mode changes each time the REPEAT key is pressed (i.e., from title repeat to chapter repeat, all repeat, to repeat off.)

When playing CD, press the REPEAT button to get the following display. TRACK ALL, and Repeat off.

When playing Mp3, press REPEAT button to get the following player mode: Single, Repeat one, Repeat Folder, Folder.

CONNECTING SPEAKERS

This well-designed DVD receiver provides optimum sound quality when the speakers used are within the range of their rated impedance.

Important

- The minimum impedance of the five speaker terminals is 6 ohm; for the subwoofer, it is 8 ohm.
- If you want to use only one speaker or listen to monophonic music, do not parallel connect individual speakers to the left and right channel terminals. See the figure on the left below.

Connecting Speaker Cables

1. Peel off approximately 1/2" of cable insulation
2. Tighten the wire end (#2 below)
3. Open cable terminal by pressing back on tab
4. Insert wire end into terminal
5. Release tab; make sure wire is in terminal securely
6. WHITE line is (-), WHITE/BLUE line is (+).

Note: To prevent damage to the circuit, care should be taken to prevent short circuiting from occurring at the positive and negative poles of the speaker cord.

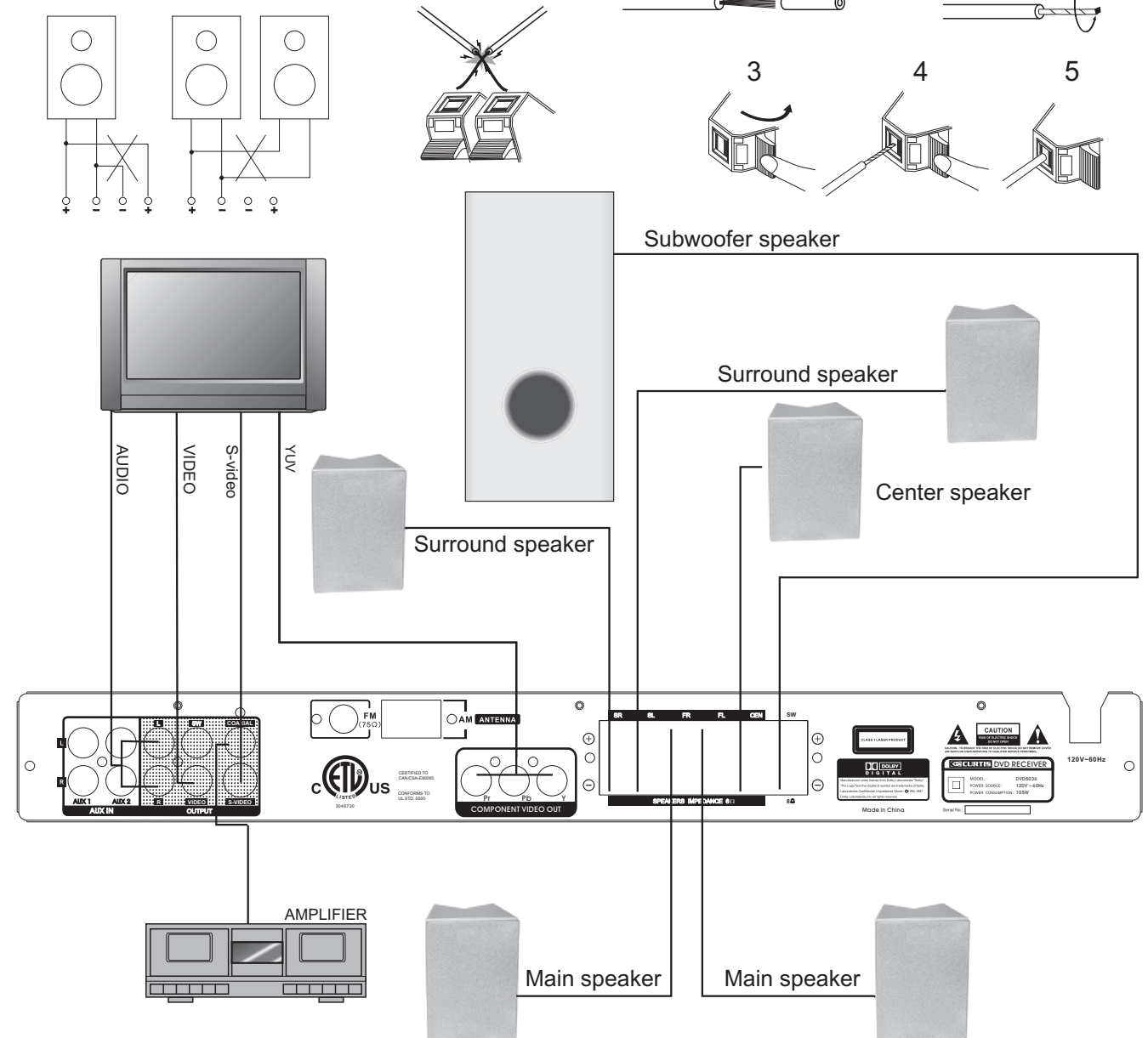
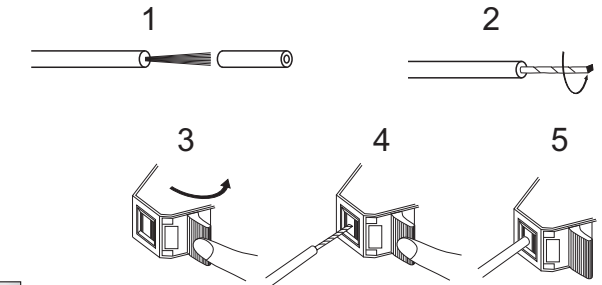

CONNECTING ANTENNA

Radio signals may be difficult to receive in some buildings and under certain conditions. The provided antennas will help in their reception. They are intended for indoor use only.

AM Loop Antenna

The placement of the AM loop antenna should be in a direction that provides the clearest reception. Keep as far as possible from DVD receiver, TV set, and speaker and power cords. If reception remains poor, an outdoor antenna may be necessary.

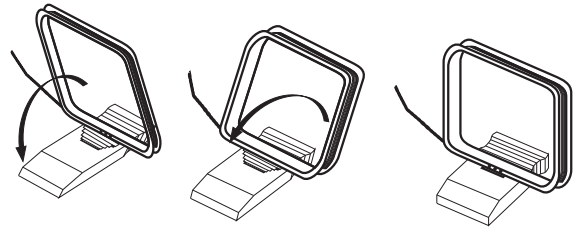

To connect the AM loop antenna:

1. Hold down handle
 2. Insert wire end into hole
 3. Release handle
- Position for best reception

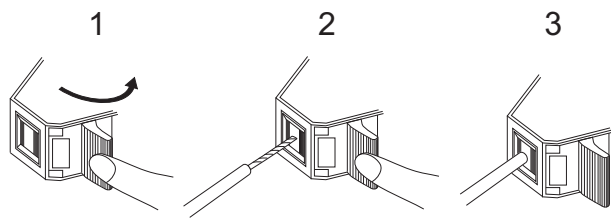

FM Indoor Antenna

The FM antenna should be fully extended and in a direction that provides the clearest signal. Secure the antenna ends in a location where distortion is a minimum. If reception remains poor, an outdoor antenna may be necessary.

To connect the FM antenna:

1. Open cable terminal by pressing back on tab
2. Insert wire end
3. Release tab; make sure wire is in terminal securely

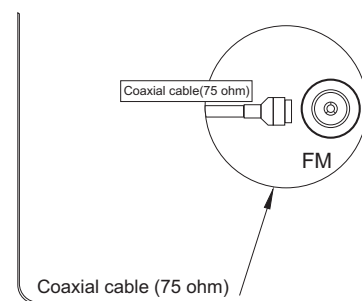
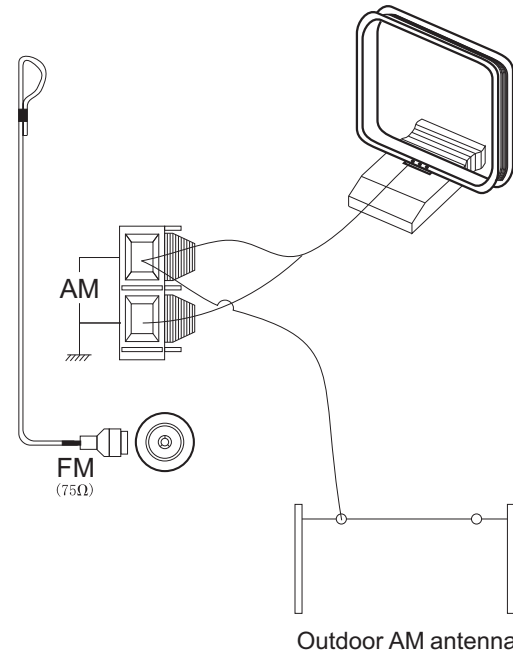

Outdoor FM antenna

FUNCTIONS

N/P

This DVD receiver supports video output of various systems, including auto, NTSC, and PAL. The picture will blink and become colourless when the wrong system is selected. If this occurs, press the N/P key on the remote control, then select the correct system (NTSC for North America, PAL for Europe). For more information on output format, refer to the TV set's manufacturer's instructions.

Subtitles

The unit has the capability to display subtitles in any of 32 different languages.

1. Press the SUBTITLE key. The subtitle menu will appear. Select the desired language by pressing the SUBTITLE key.



2. To remove the subtitles from view, press the SUBTITLE key until they disappear.

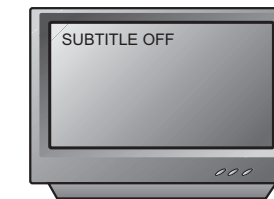

Note: The disc being played must be multi-subtitle encoded.

Camera Angle

The ability to change the camera angle allows viewer to play director and watch a movie from different perspectives.

1. Press the ANGLE key on the remote control. With each press, the camera angle changes.
2. The key may be pressed only when the flashing angle icon appears in the unit's display panel.



Note: Camera angle may be changed only in discs with multi-angle capability encoded into them.

Language

The unit has the capability to show movies in one of eight languages.

1. Press the LANGUAGE key. The language menu will appear. Select the desired language by pressing the LANGUAGE key.



Note: The disc being played must be multi-language encoded.

LOCATING A TITLE

DVD discs are normally divided into titles, which are then sub-divided into chapters. A specific title can be easily found with this unit. Specific titles can be found using either the title menu function, if the DVD disc contains a title menu, or through its unique title number.

Title Menu Function

1. Press the TITLE key. The title menu will appear on the TV screen.
2. Press the appropriate scroll key to select the desired title. A title may also be located by pressing its assigned number with the number buttons.
3. Press the ENTER key. This will start playback from chapter 1 of the selected title.

Note:

Some discs do not respond to this function. If different instructions appear on the TV screen, follow those instructions. The instructions given here describe the basic procedure. Procedures may vary depending on the content of the DVD disc. When playing a VCD2.0 disc, TITLE key can be used to return to menu.

2.1/5.1 DONMIXING SELECTOR

Press 2.1/5.1 key to select stereo or 5.1 channel output.

BASIC DVD OPERATION

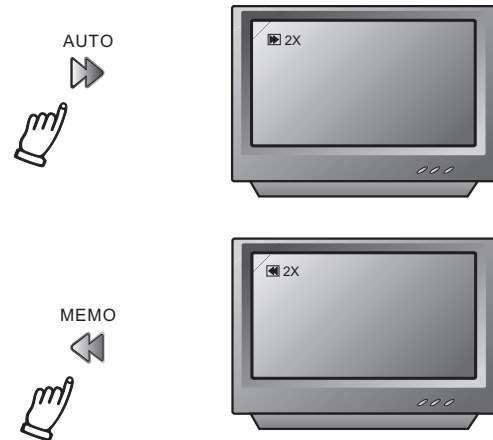

To activate either function, simply press the ►► key or ◀◀ key on the remote control. The speed changes each time the key is pressed. To resume normal playback, press the PLAY key.

Memory Playback

This unit allows the viewer to stop playback, then later continue playback from that exact disc location. Press the STOP key to halt playback. The unit then will memorize the location where playback was stopped. To resume watching, press the RESUME or PLAY key and the unit will resume playback from the exact location where playback was stopped. (Exclude Mp3 DISC)

When you play DVD discs, press MENU or TITLE key return menu and title, the unit then will memorize the location, To resume watching press the RESUME key and the unit will resume playback from the exact location.

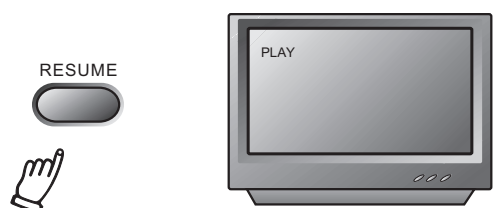

Slow Motion

This DVD receiver has the ability to play discs in slow motion in either forward or reverse direction. Each time the SLOW key is pressed, the speed will slow from forward slow speed 1/2, to 1/4, to 1/8, to 1/16 to reverse slow speed 1/2, to 1/4, to 1/8, to 1/16, to normal speed. To resume normal playback, press the PLAY key.

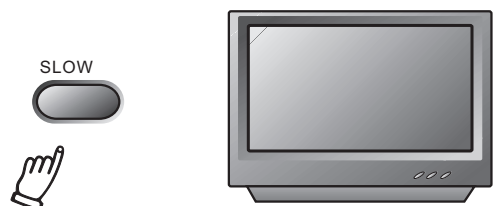

FUNCTIONS

Screen Display

While a disc is playing, the status of various functions may be checked, such as the title, track number, and several time categories.

1. Press the DISPLAY key once and the title appears along with the chapter and how much time has played.



2. Press the DISPLAY key again and the remaining time for that particular title appears.



3. Press the DISPLAY key again and the total elapsed time for that particular chapter appears.

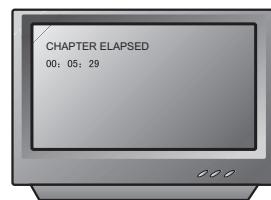

4. Press the DISPLAY key again and the total remaining time for that particular chapter appears.

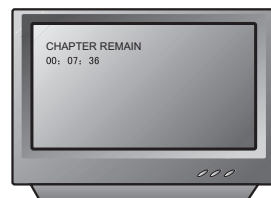

5. Press the DISPLAY key again and the display turns off.

CONNECTING POWER SUPPLY

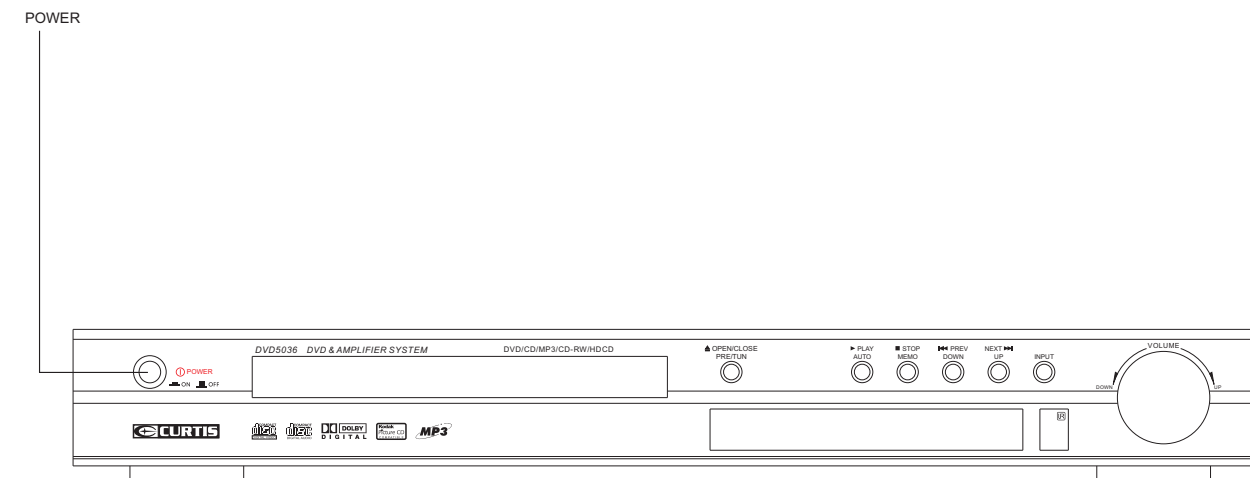

Before plugging the power cord into the AC outlet, check to make sure all of the connections have been properly completed. When they have been, carefully plug power cord into outlet.

Press the POWER button on the front panel to power the unit. The display panel will light.

When the unit is initially powered, a brief surge of electricity may cause interference with other electronic equipment on the same circuit. If this occurs, connect the unit to an outlet on a different circuit.

BASIC OPERATION

Selecting Sound Source

1. Press any function button (DVD, AM/FM, AUX1, AUX2) to select the desired sound source. The appropriate symbol will appear in the display.
2. When the AM/FM tuner button is pressed, the last station listened to will play.

Note: The desired program source will not play unless it and the selected signal button coincide with the active program source signal input.

Volume Control

The volume may be adjusted by either turning the large volume knob on the front panel or using the appropriate volume button on the remote control.

Mute

Pressing the MUTE button temporarily mutes every speaker. To resume audio, press MUTE button again.

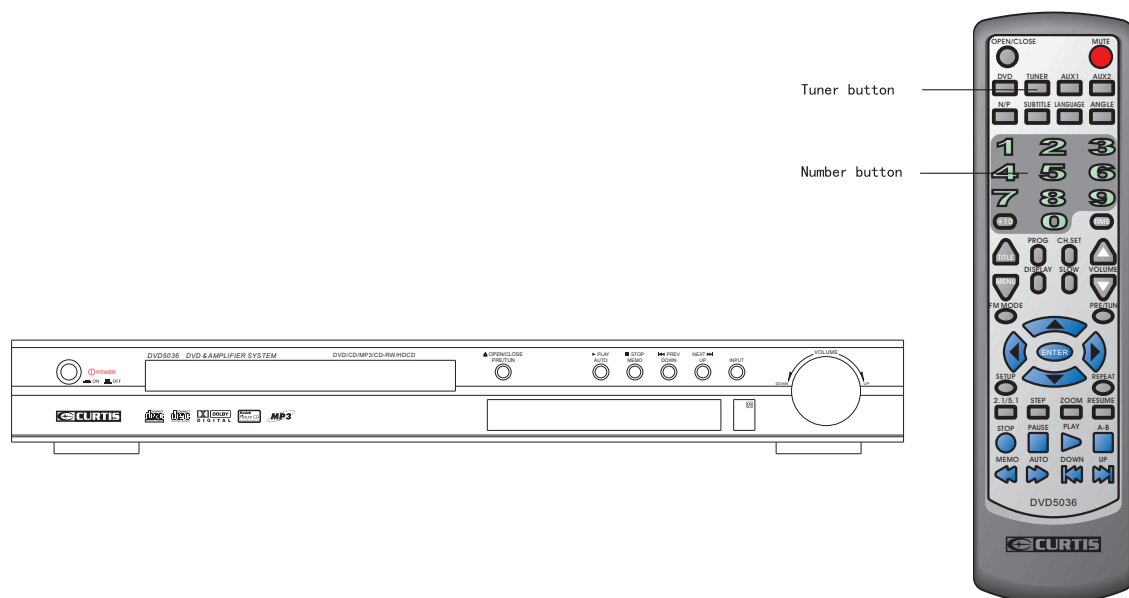

Positioning

1. Press TUNER button to select desired wave band (AM or FM).
2. Press UP or DOWN button to find a station. The frequency will change with each press. When a station's signal is received, it will appear in the display.
3. To lock onto a station quickly, hold the UP or DOWN button for two seconds. The unit will start automatic tuning. When a station is found, automatic tuning stops.
4. To add a station to memory, press the MEMO button. The memory storage number will blink for four seconds in the display. Press MEMO again to store the station.

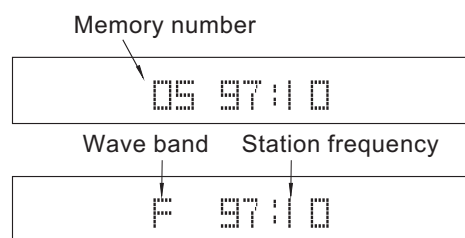

5. To reduce noise when an FM-stereo program has been received, press the FM button. The word STEREO will disappear from the display. The program is now heard in monographic form, reducing the noise. To resume stereo play, press the FM button again.

Automatic Tuning

This unit will store up to 50 individual AM or 50 individual FM radio stations in its memory.

1. Press the AUTO button. The word AUTO will appear in the display and the automatic tuning mode is activated.
2. Stations will be stored in ascending order until 50 stations of that particular wave band have been saved. When a station is stored, the memory storage number, as well as the station's frequency, will flash for four seconds in the display.
3. When the total number of stations reaches 50, in a particular wave's (AM or FM) memory, no further station in that wave band will be saved.

To Play Preset Stations

1. Press the TUNER button to select the desired wave band.
2. Press the PRE/TUN button.
3. Press any of the numbered buttons to select the desired station's memory number. For example, to play the station at memory #5, simply press the 5 button; for memory #17, press the 1 button followed by the 7 button.
4. Stations in the memory function may also be accessed by pressing the UP or DOWN button.

Once the unit is connected to a television set and any other accessory equipment, you are ready to enjoy the excitement of DVD videos or your favorite CDs and MP3 files.

To play a DVD video disc:

Turn on the TV and select the A/V mode. If the set features an SCART connection, be sure the SCART mode is selected from the TV menu. Turn on amplifier, if connected. Select AC-3 or DVD mode.

To play an audio disc:

Turn on the audio system and choose the input source that is connected to the DVD player. Set the SPDIF OUTPUT to SPDIF OFF from the SETUP MENU display if you don't have the proper equipment for Dolby Digital surround sound.

1. Press the POWER key on front panel. DISC LOADING appears on screen.



If there is no disc, NO DISC shown on screen:



2. Press the OPEN/CLOSE key. The disc tray will open.

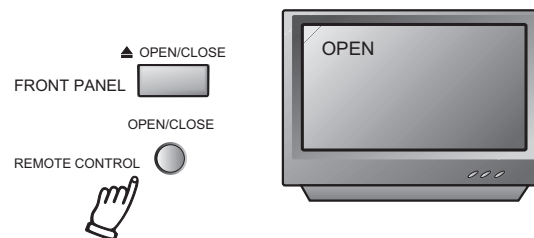

3. Place the disc on the disc tray. Be sure play side is face down on the tray.

4. Press OPEN/CLOSE key to close tray. The disc tray will close. The disc type will appear in the upper-left-hand corner of the screen.

Once it has read the disc, the unit automatically will begin playback. When playing a DVD, the DVD title or menu will appear. CD tracks are played in sequence.

Note:

- It is possible to damage a disc if it is not placed correctly on the guides in the disc tray. This may also cause the DVD player to malfunction. Do not force or place anything other than a 5" DVD or CD onto the disc tray.
- Never move the DVD player during playback, as this may cause damage to the disc as well as the player. To open and close the disc tray, only use the OPEN/CLOSE key found on both the remote control and on the unit's front panel.

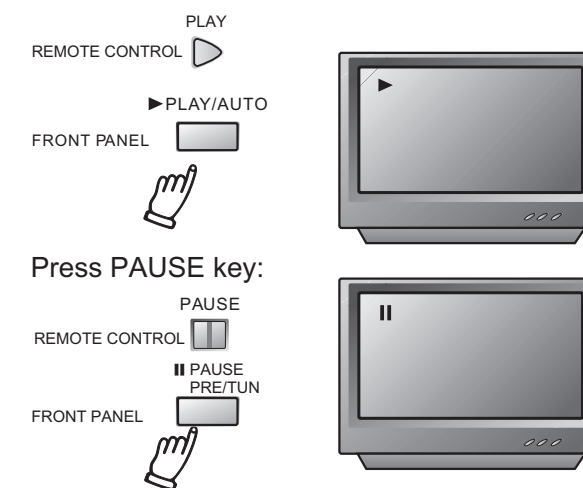

5. PREV/NEXT playback
Press I◀◀key or ▶▶Ikey, play previous or next track. To resume normal playback, press PLAY key.



6. Fast Forward/Reverse Playback

The unit features both fast forward and fast reverse playback. Either mode will speed up: 2x, 4x, 8x, 16x, 32x.