

50" FHD LED TV

C50223DVB-LED Ver2

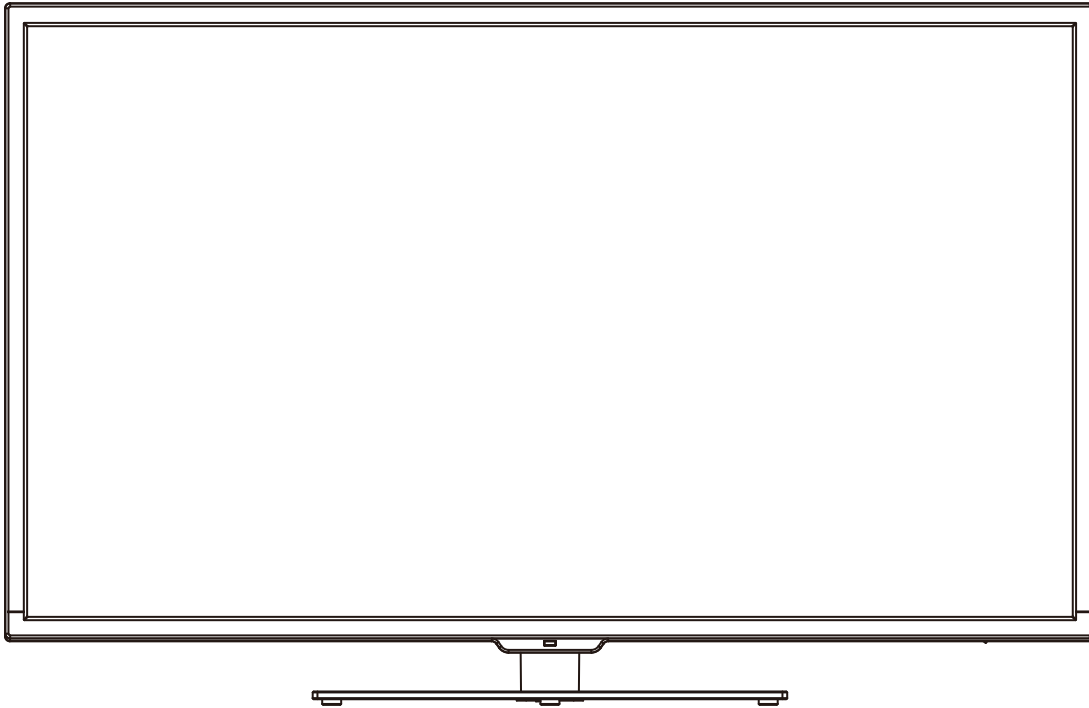

User Guide

Contents

Unpacking the TV / Accessory's	1
Installing / Removing the Base Stand	2
<hr/>	
Front / Right Side View and Controls	3
Rear View and Sockets	4
<hr/>	
Remote Control	5-6
Installing Batteries in the Remote Control	7
Remote Control Operation Range	7
<hr/>	
Making Video and Audio Connections	8
Connecting an AV Device with an HDMI Cable	8
Connecting a Computer with a VGA Cable	9
Connecting an AV Device with a Component (YPbPr) cable	9
Connecting an AV Device with a SCART Cable	10
Connecting an AV Device with Composite Cable	10
Connecting a Digital Audio Receiver	11
Connecting Headphones	11
Turning the TV on for the First Time	12-13
<hr/>	
Basic Operation	13
<hr/>	
OSD Menu	14-20
1. Picture Setting	14-15
2. Sound Setting	16
3. Channel Setting	17-19
4. Feature menu	20-23
5. Setup menu	24
<hr/>	
EPG(Electronic Programme Guide)(DTV Mode)	25
Teletext(ATV Mode)	26
Digital Teletext(DTV Mode)	26
<hr/>	
Connecting a USB Storage Device	27
Viewing Photos	28
Listening to Music	28-29
Watching Movies	29-30
Viewing Texts	30
Time Shift Function(DTV Mode)	31
Recording DTV Programme onto a USB Storage Device	31
Timer Porgramming	32
Play Recorded Programme	33
<hr/>	
Maintenance	34
Hints and Tips	34-35
Display Modes	36
Specifications	37
Safety Warnings	38

Thank you for purchasing your new 50" FULL HD LED TV.

Your new TV has many features and incorporates the latest technology to enhance your viewing experience. We recommend that you spend some time reading this instruction manual in order that you fully understand these features. You will also find some hints and tips to help you resolve any issues. Read all the safety instructions carefully before use and keep this instruction manual for future reference.

Unpacking the TV / Accessory's

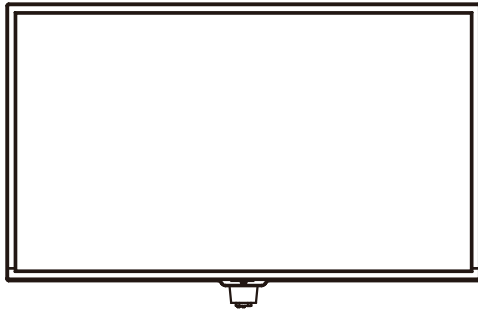

TV set



Stand & Screws



Remote Control

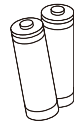

Batteries

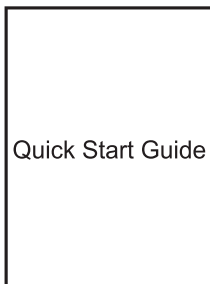

Quick Start Guide



Warranty Card



Gold Care

Installing / Removing the Base Stand

The parts

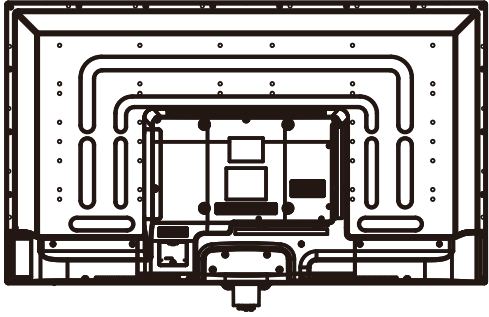

TV set



Stand



Screws(supplied)

Installation

Place the TV face down on a soft and flat surface (blanket, foam, cloth, etc.) to prevent any damage to the TV.

Put the stand to the neck of the TV set as shown below.

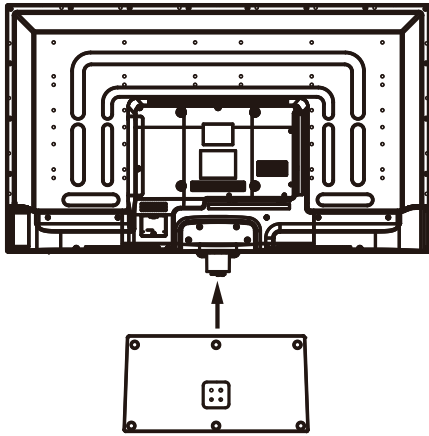

Attach the stand with the supplied screws.

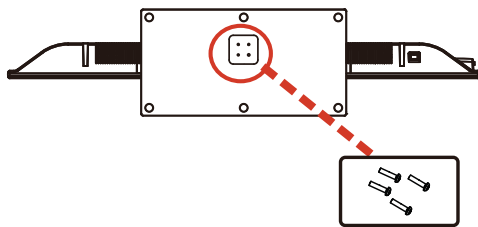

This unit is VESA-Compliant and designed to be wall mounted with a VESA-Compliant 200x200mm mounting kit.

Mount this unit according to the instructions of the wall bracket(not supplied)

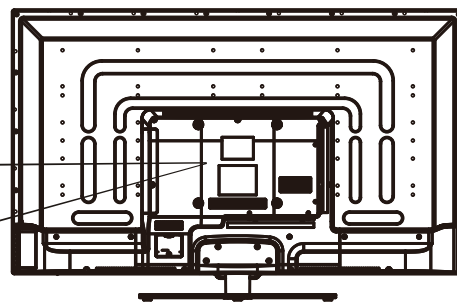
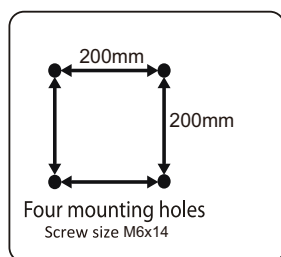

Front / Right Side View and Controls

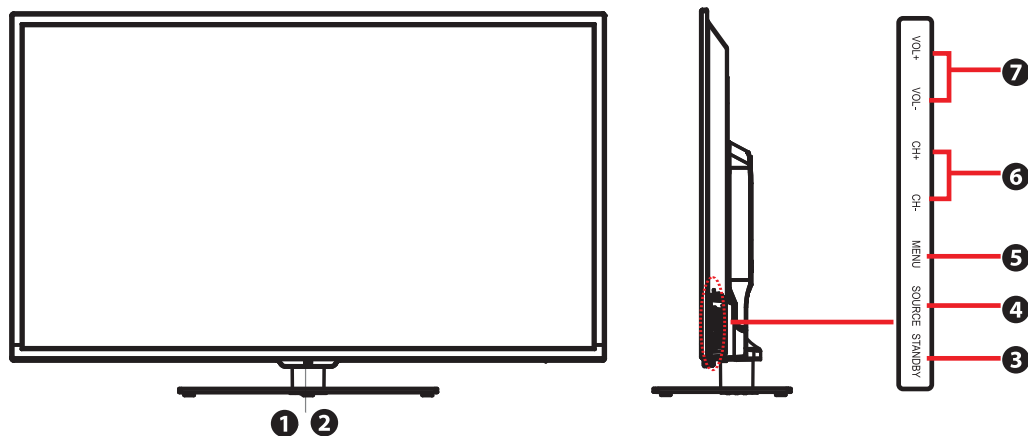

Item	Description
1 POWER LED	Illuminates green when the TV is turned on. Illuminates red when the TV is in standby mode. The LED will alternate between red and green when the PVR timer programming has started in the standby mode.
2 IR (Infrared Receiver)	Receives IR signals from the remote control. Do not put anything near the sensor, as its function may be affected.
3 STANDBY	Switches the TV on from standby mode. Switches the TV back to standby mode.
4 SOURCE	Press to select among different input signal sources: DTV / ATV / SCART / YPbPr / PC / HDMI / AV / USB. Confirmed the selection on OSD menu.
5 MENU	Displays the OSD (on screen display) menu.
6 CH + / -	Press to select a channel or select a sub-menu from the OSD menu.
7 VOL + / -	Adjusts the volume. Press to select and adjust a setting in the OSD menu.

Rear View and Sockets

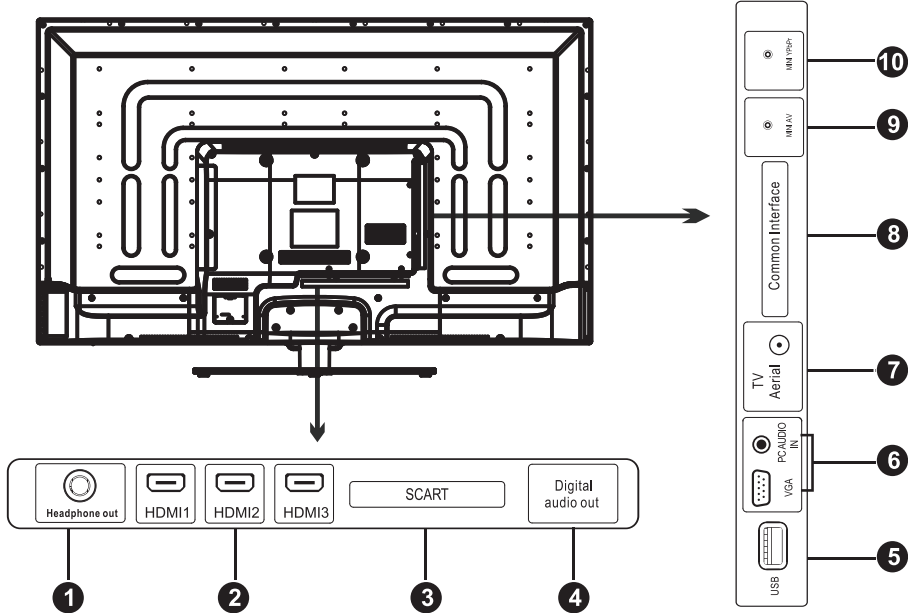

Socket	Description
1 Headphone out	To connect to the earphones.
2 HDMI IN	To connect to a High-Definition (HD) signal output device, such as a set-top box, blu-ray disc player or AV receiver.
3 SCART	To connect to a VCR, DVD Player, or other AV device with a SCART output socket.
4 DIGITAL AUDIO OUT (COAXIAL)	To connect to the audio socket on the digital/standard 5.1 audio system.
5 USB	Allows the insertion of a USB storage device to play video, audio, photo and text files (Media mode) and record DTV programmes on to a USB storage device.
6 VGA	To connect to a comPUter or other devices with a VGA interface.
7 TV Aerial	To connect to the aerial socket on the wall with the RF coaxial cable.
8 CI (Common Interface) Slot	Allows the insertion of a Common Access Module.
9 MINI AV	To connect to the Composite VIDEO and AUDIO (L/R) output sockets on external video devices.
10 MINI YPBPR / AUDIO (L/R)	To connect to a DVD player, Digital Set-Top-Box, or other AV devices with component (YPbPr) video and audio output sockets.

Remote Control

Dependant on the Model of the TV some keys will have no function

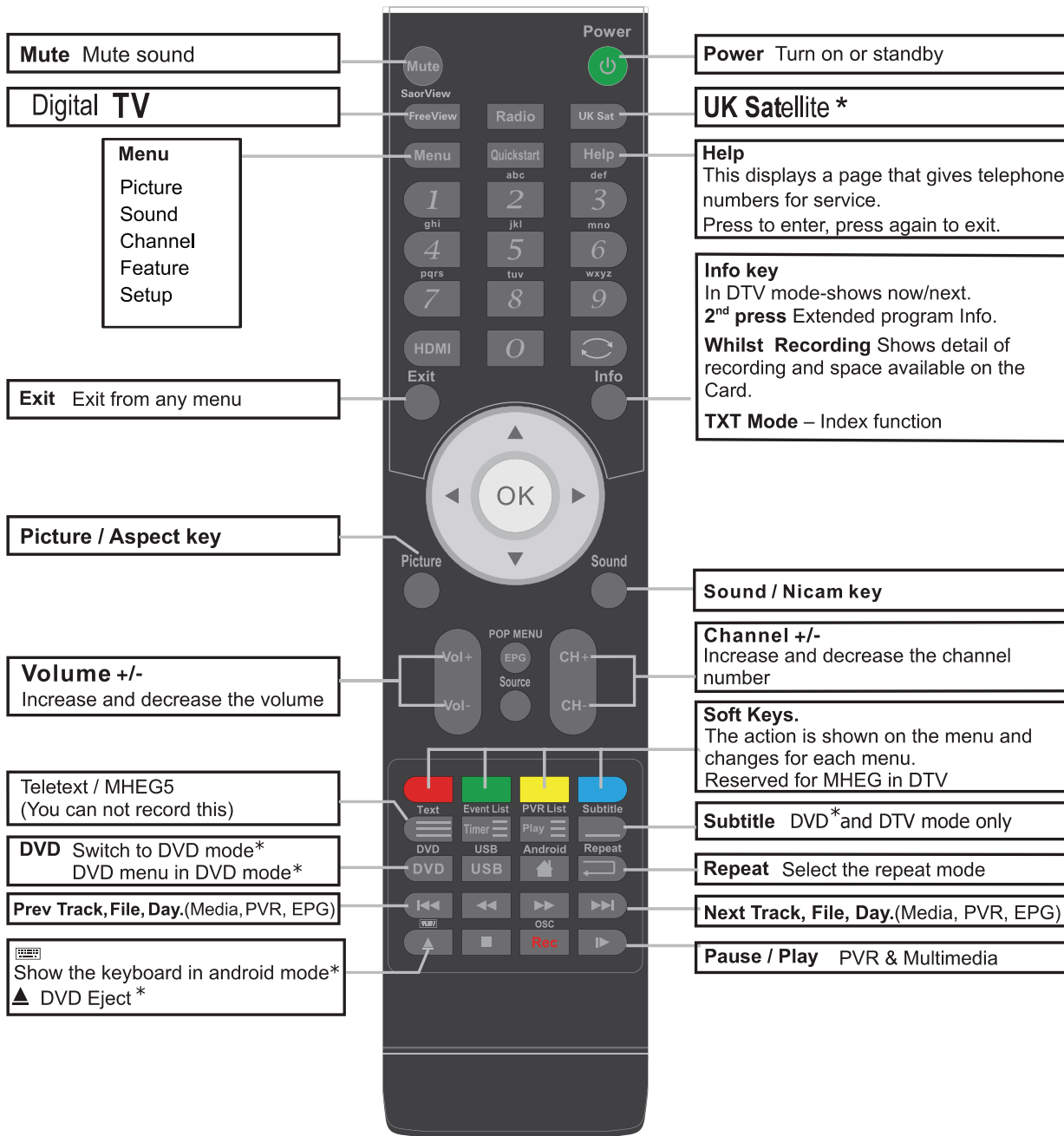

*Dependant on Model

Remote Control

■ Functions of remote control buttons

Dependant on the model of the TV some keys will have no function

I Functions of remote control buttons

Dependant on the model of the TV some keys will have no function

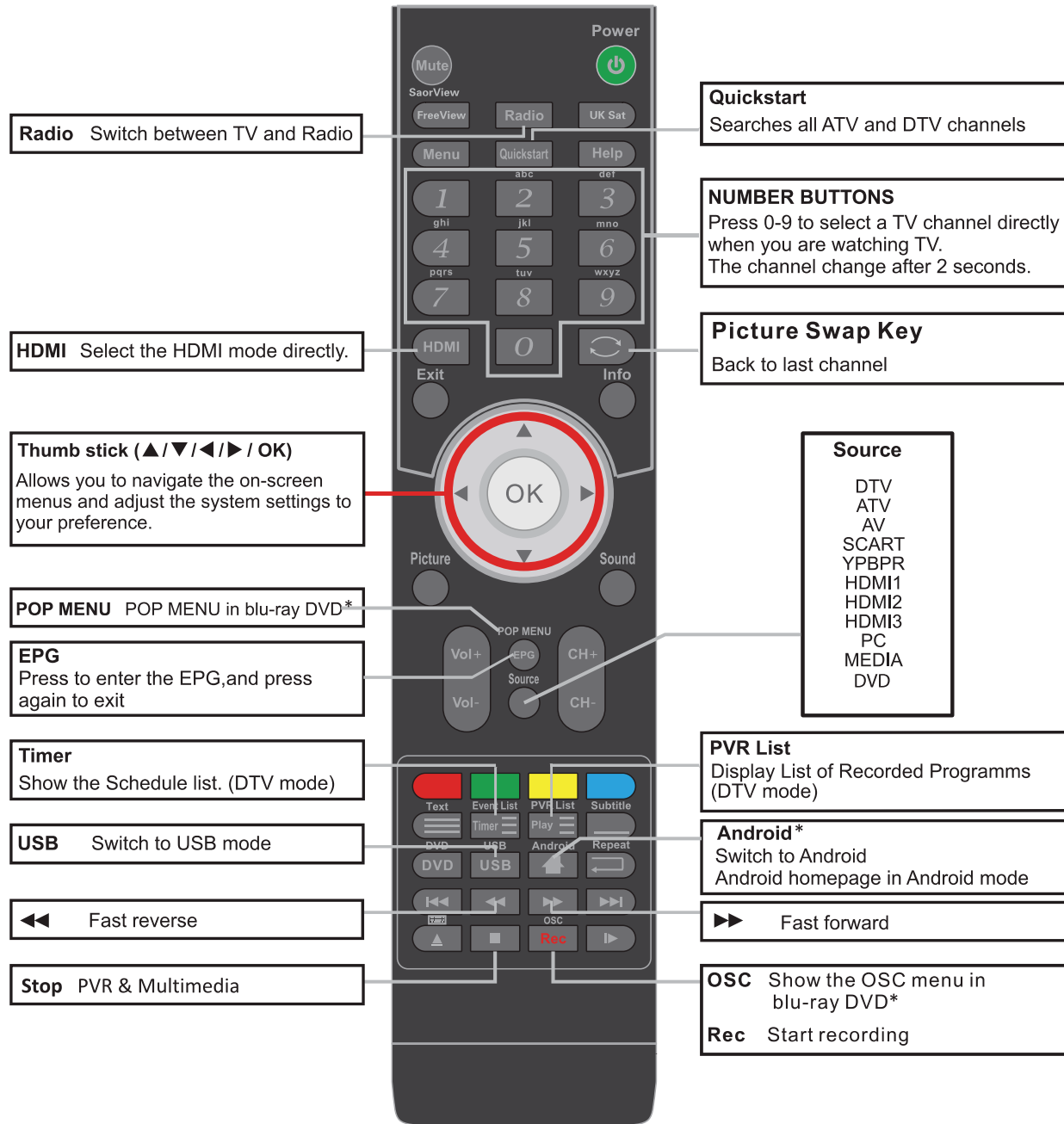

*Dependant on Model

Installing Batteries in the Remote Control

1. Press and lift the back cover to open the battery compartment of the remote control.
2. Insert two 1.5V AAA size batteries. Make sure to match the (+) and (-) ends of the batteries with the (+) and (-) ends indicated in the battery compartment.
3. Close the battery compartment cover.

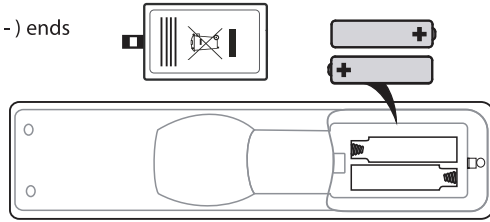

Handling the Batteries

- Improper or incorrect use of batteries may cause corrosion or battery leakage, which could cause fire, personal injury or damage to property.
- Only use the battery type indicated in this manual.
- When the batteries are exhausted, the remote will not function. Replace both batteries at the same time with new ones.
- Do not install new batteries with used ones and do not mix different types of batteries.
- Do not dispose of used batteries as domestic waste. Dispose of them in accordance with local regulations.



Handling the Remote Control

- Take care of your fingernails when you press and hold the battery release tab.
- Do not drop or cause impact to the remote control.
- Do not spill water or any liquid on the remote control.
- Do not place the remote control on a wet object.
- Do not place the remote control under direct sunlight or near sources of excessive heat.
- Remove the battery from the remote control when not in use for a long period of time, as it could cause corrosion or battery leakage and may result in physical injury and/or property damage including fire.

Remote Control Operation Range

Point the remote control at the TV no more than 5 metres from the remote control sensor on the TV and within 60° in front of the TV. The operating distance may vary depending on the brightness of the room.

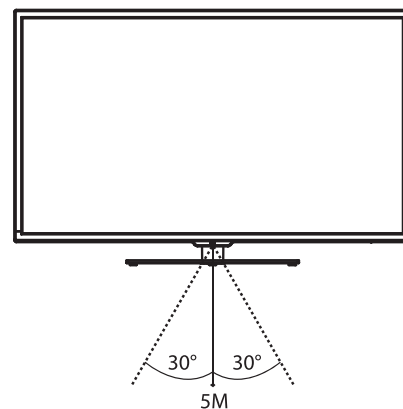

Remote Code:0156







To use your sky remote control with this TV follow the instructions given with the sky remote to programme different codes.



Making Video and Audio Connections



Not all AV devices have the ability to connect to a TV, please refer to the owner's manual of your AV device for compatibility and connection procedures.

When connecting any external AV device, do not connect the mains cable to the mains socket until all other connections are complete.

Best Video Performance ↑		Signal Type	Separate Audio Connection Required
	 HDMI	HDMI (480i/480p/576i/576p/720p/1080i/1080p)	No
	 VGA	PC	Yes  PC AUDIO
	 Mini YPbPr	Component Video (480i/480p/576i/576p/720p/1080i/1080p)	Yes  Mini AV
	 SCART	SCART (RGB Input)	No
	 Mini AV	Composite Video	No

Connecting an AV Device with an HDMI Cable

- This TV can accept High-Definition Multimedia Interface (HDMI) and supports HDCP (High-Bandwidth Digital Content Protection) Protocol.
- The TV has a total of HDMI input sockets, please make sure the correct input source is selected corresponding to your connected HDMI input socket.
- When you connect to the output of an HD ready player (blu-ray disc player, game console, set-top box or computer) switch to the HDMI function and the TV will automatically detect the resolution used by the HDMI source.
- To get the best picture quality, adjust the blu-ray disc player, game console or set-top box output resolution up to 1920 x 1080p.

1. Use an HDMI cable to connect the TV's HDMI input socket to the external AV device's HDMI output socket.
2. Plug the connected devices into the mains socket
3. Press the **STANDBY** button on the TV or the  button on the remote control to turn on your TV.
4. Press the **SOURCE** button on the TV or the **SOURCE** button on the remote control to display the Source List. Use the   buttons to select **HDMI1/2/3** and then press the **OK** button to confirm.

 Although this TV is able to connect to an HDMI device, it is possible that some devices may not operate correctly.

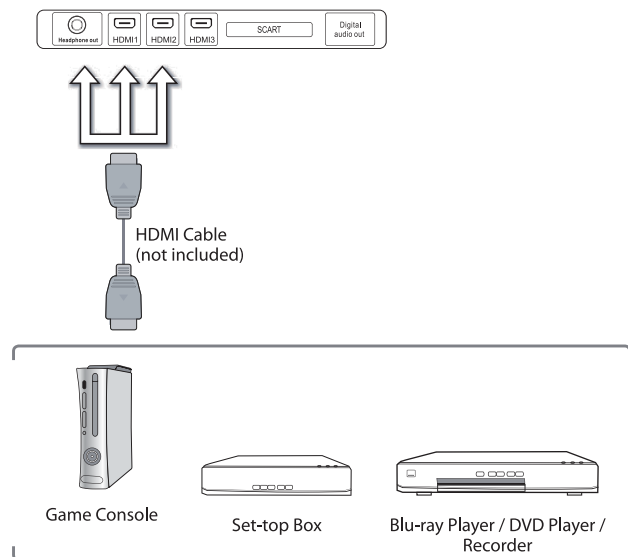

Connecting a Computer with a VGA Cable

1. Use a VGA cable to connect the TV's PC input socket to a computer's VGA output socket. Use an audio cable to connect the TV's PC AUDIO input socket to the computer's audio output socket.
2. Plug the connected devices into the mains socket
3. Press the **STANDBY** button on the TV or the **⏻** button on the remote control
4. Press the **SOURCE** button on the TV or the **SOURCE** button on the remote control to display the Source List. Use the **▲▼** buttons to select **PC** and then press the **OK** button to confirm.



- The best resolution is 1920 x 1080.
- If your computer is set to shut down after a few minutes of idle mode, the TV will also switch to standby due to no signal being received, this is to save energy. Press the **STANDBY** button at the right side of the TV when viewed from the front or the **⏻** button on the remote control to restart the TV.

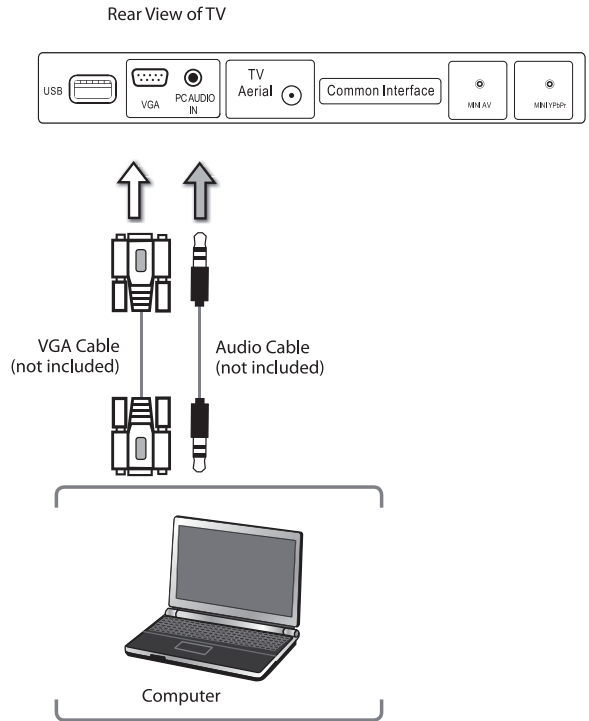

Connecting an AV Device with a Component (YPbPr) Cable

1. Use a component cable to connect the TV's Mini YPbPr input sockets to an external AV device's component output sockets.
2. Use an AV cable to connect the TV's Mini AV input sockets to the external AV device's component audio output sockets. (Audio Left = white, and Audio Right = red)

Component port on the TV	Mini YPbPr		
Video output ports on DVD player	Y	Pb	Pr
	Y	Cb	Cr

3. Plug the connected devices into the mains socket
4. Press the **STANDBY** button on the TV or the **⏻** button on the remote control
5. Press the **SOURCE** button on the TV or the **SOURCE** button on the remote control to display the **Source List**. Use the **▲▼** buttons to select **YPbPr** and then Press the **OK** button to confirm.

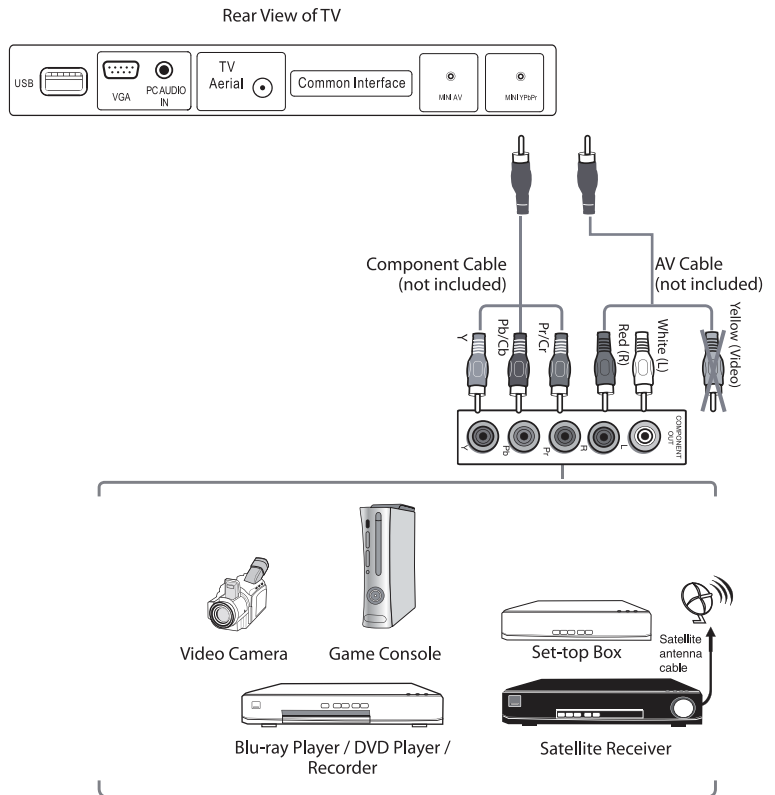

Connecting an AV Device with a SCART Cable

1. Use a SCART cable to connect the TV's SCART input socket to an external AV device's SCART output socket.
2. Plug the connected devices into the mains socket
3. Press the **STANDBY** button on the TV or the **⏻** button on the remote control
4. The TV will change the input source to **SCART** automatically once the AV device is switched on.

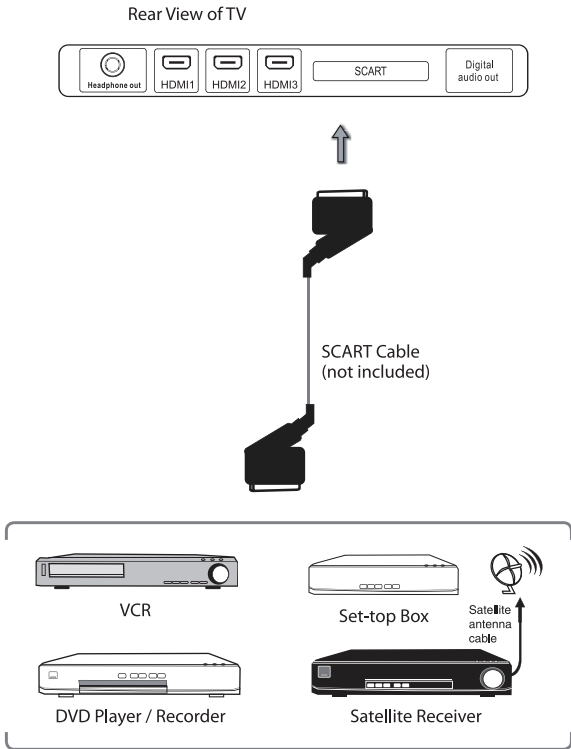

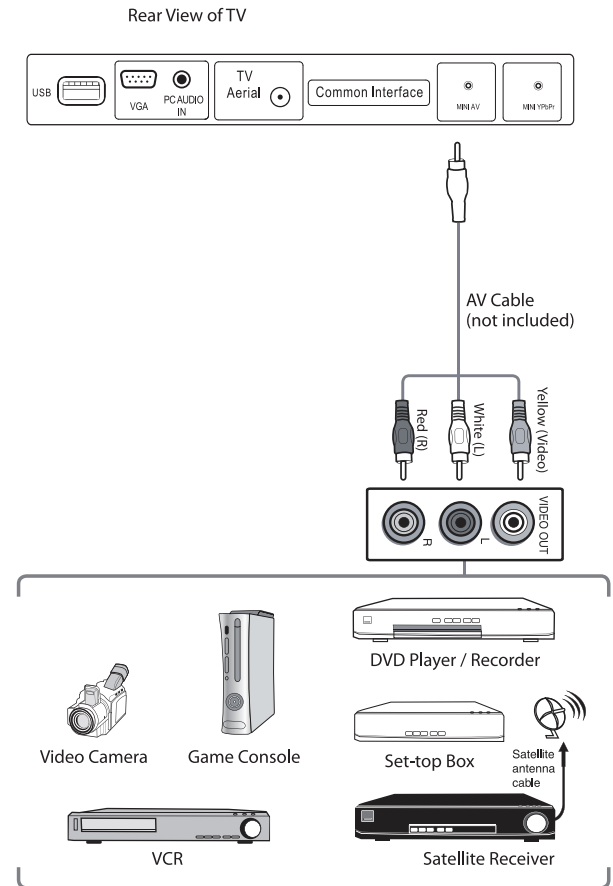

Connecting an AV Device with Composite Cable

1. Use an AV cable to connect the TV's Mini AV input sockets to an external AV device's composite audio/video sockets. (Video = yellow, Audio Left = white, and Audio Right = red)
2. Plug the connected devices into the mains socket
3. Press the **STANDBY** button on the TV or the **⏻** button on the remote control
4. Press the **SOURCE** button on the TV or the **SOURCE** button on the remote control to display the Source List. Use the **▲▼** buttons to select **AV** and then press the **OK** button to confirm.



Connecting a Digital Audio Receiver

For better sound quality, you may want to play the audio through your multi-channel audio receiver.

1. Use an audio cable to connect the TV's Digital Audio out socket to an external audio receiver's audio coaxial input socket.
2. Plug the connected devices into the mains socket
3. Press the **STANDBY** button on the TV or the  button on the remote control
4. Press the **SOURCE** button on the TV or the **SOURCE** button on the remote control to display the Source List. Use the   buttons to select any desired input source and then press the **OK** button to confirm.



The TV's volume control will have no effect. You may control the audio level via the Audio Receiver.

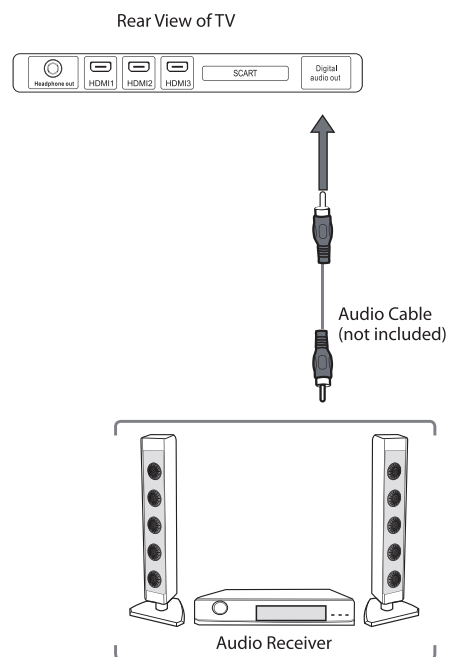

Connecting Headphones

Connect your headphones to the TV's Headphone out socket.

Before putting on headphones, turn the volume down then put the headphones on and slowly increase the volume until you reach a comfortable listening level.



Long-term exposure to loud music may cause hearing damage. It is best to avoid extreme volume when using earphones, especially for extended periods.

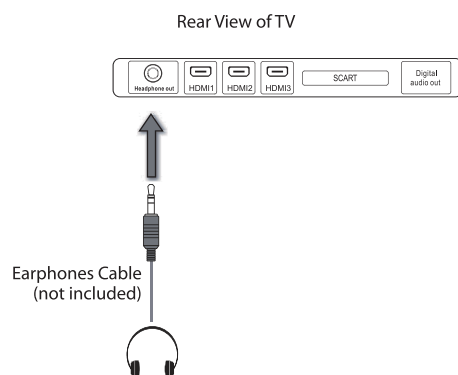

Turning the TV on for the First Time

1. Connect one end of the RF coaxial cable to the aerial socket on the wall and the other end of the cable to the Aerial socket at the rear bottom of your TV.



Do not connect the TV to the mains supply until you have completed all the connections.

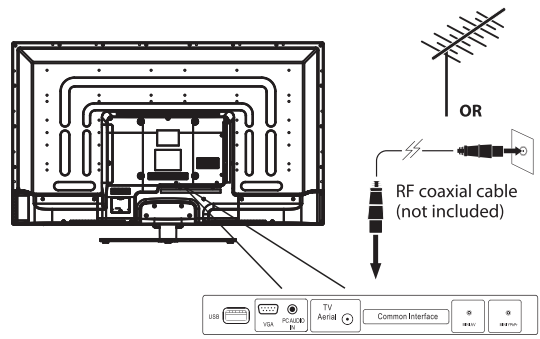

2. Connect the mains cable to the mains socket after you have completed all the connections.

3. At this stage, the TV switches to standby mode. The red LED indicator will illuminate on the front panel of the TV.

4. In standby mode, press the **STANDBY** button on the TV or the  button on the remote control to turn the TV on. The LED indicator will change from red to green.

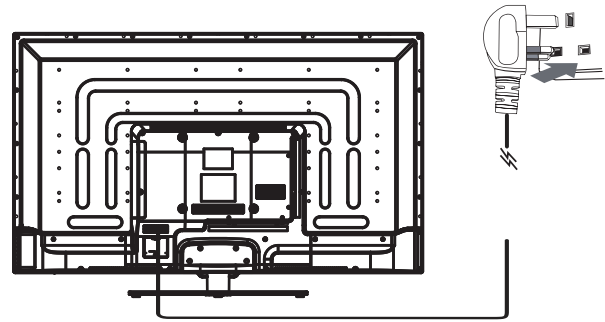

The **STANDBY** button is located on the rear right side of the TV.



- Always disconnect the TV from the mains socket when not in use for a long period of time.
- The **STANDBY** button on the rear right side of the TV or the  button on the remote control is only used for switching the TV into standby, it does not disconnect the TV from the mains power. To completely disconnect the mains power, please remove the mains cable from the mains socket.

5. If this is the first time you are turning on the TV and there are no programs in the TV memory, the Quick Start menu will appear on the screen. There are 4 setups as follow:

Setup 1: Select your language.

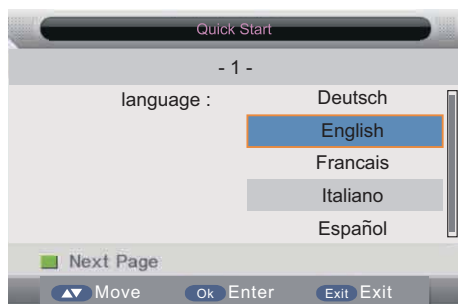

Setup 2: Select your Country.



Setup 3: Select your Auto Power off preference.

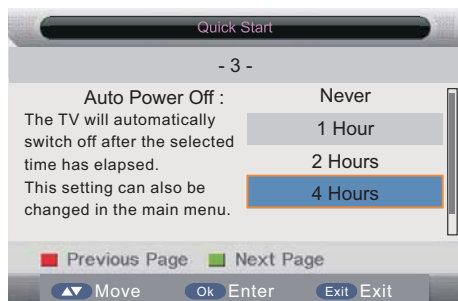

Setup 4: Select your TV service

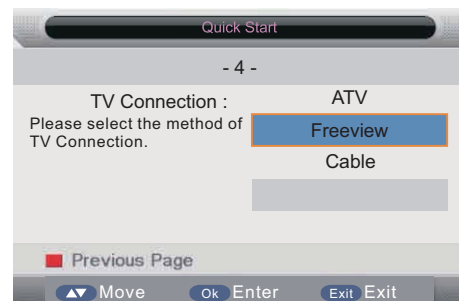

6. Ensure your aerial, cable or dish is plugged in to the TV and then press OK.

The TV will start to install the service you have selected. This could take some time depending on your selected service. You can tune an additional service at any time by pressing the Quick Start button.

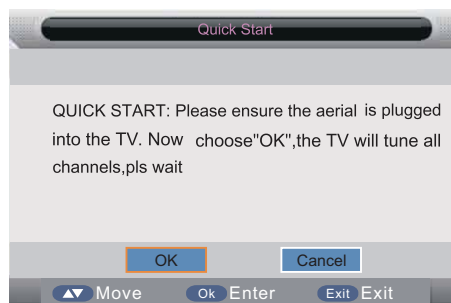

Selecting the Input Source

1. Press the **Source** button on the TV or the **Source** button on the remote control to display the Input source list.
2. Press the **▲▼** buttons to select the input source that you want: DTV, ATV, AV, SCART, YPBPR, HDMI1, HDMI2, HDMI3, PC, Media.
3. Press the **OK** button to confirm your selection. If you do not press the **OK** button to confirm, the TV will automatically confirm the selected input source within 4 seconds.



In DTV mode, press the Radio button to switch to TV / digital radio channels directly.



Channel Selection

- Press the **CH+ / -** buttons on the TV or on the remote control repeatedly or the **0-9** buttons on the remote control to select the channel.



Alternative

Press the **OK** button to enter the **Channel List**. Then use the **▲▼** buttons to highlight and select the channel. Press the **OK** button to view the selected channel.

- If a blocked channel is selected, the password screen will be displayed. Press the **0-9** buttons to enter the password, the channel will then be unlocked (refer to page 20 for details on LOCK).
- Press the **↶** button to return to the previously viewed channel.

Display Channel Information

- Press the **Info** button to view the current information.

Volume Adjustment

- Press the **VOL+/-** button on the TV or on the remote control to adjust the volume.
- If you wish to switch the sound off, press the **Mute** button. Press the Mute button again or the **VOL+ / -** button to resume audio listening.

Picture Setting

Allows you to set your preferred picture mode.

1. Press the **Menu** button and then press the **▲▼** buttons to select the **PICTURE** menu.
2. Press the **OK** or **▶** buttons and then press the **▲▼** buttons to select the following picture options and then press the **OK** button.



Picture Mode Press the **▲▼** buttons to cycle among picture mode: Dynamic / Standard / Mild / User and then press the **OK** button to confirm.



Alternative

You may press the **Picture** button once and then press the **◀▶** buttons to select the picture mode directly.



Brightness Press the **◀▶** buttons to increase or decreases the amount of white in the picture.(for User mode)

Contrast Press the **◀▶** buttons to adjust the difference between light and dark levels in the picture.(for User mode)

Sharpness Press the **◀▶** buttons to adjust the level of crispness in the edges between light and dark areas of the picture.(for User mode)

Colour Press the **◀▶** buttons to control the colour intensity.(for User mode)

Tint (For NTSC format) Press the **◀▶** buttons to adjust the balance between red and green levels. (Tint is only available for NTSC signal input via the SCART or AV IN.)

Colour Temperature Press the **▲▼** buttons to cycle among colour temperature: Standard / Cool / Warm and then press the **OK** button to confirm. Adjusts the colour components independently to achieve a warm or cool.

- **Standard**
- **Cool:** Increases blue tint
- **Warm:** Increases red tint



Aspect Ratio Press the **▲▼** buttons to cycle among aspect ratio: 4:3 / 16:9 Full / Zoom1 / Zoom2 and then press the **OK** button to confirm.









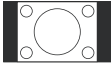
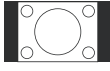

Alternative

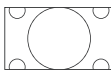
You may press the **Picture** button twice and then press the **◀▶** buttons to select the aspect ratio directly.

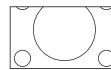

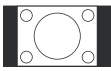
Picture Setting

	Input Signal 4:3		Input Signal 16:9	
4:3	This selection will allow you to view a picture with an original 4:3 aspect ratio. Black bars will appear on both the left and right of the screen.		This selection will allow you to adjust the picture horizontally, in linear proportion. Black bars will appear on both the left and right of the screen.	
16:9	This selection will allow you to adjust the picture horizontally, in linear proportion, to fill the entire screen.		This selection will allow you to view a picture with an original 16:9 aspect ratio.	
Zoom1	This selection will allow you to zoom in the picture without any alteration, while filling the entire screen. However, the top and bottom of the picture will be cropped.		This selection will allow you to zoom in the picture without any alteration, while the 4 sides of the picture will be cropped.	
Zoom2	This selection is similar to 16:9 mode, but the picture slightly stretches vertically and clips off a little from the top and bottom.		This selection is similar to 16:9 mode, but the picture slightly stretches vertically and clips off a little from the top and bottom.	
Just scan (in HDMI mode only)	This selection will detect the resolution of the HDMI signal and display an image. with the same number of pixels		This selection will detect the resolution of the HDMI signal and display an image. with the same number of pixels	

Noise Reduction Press the ▲▼ buttons to select to reduce the noise level of the connected device: Off / Low / Middle / High and then press the **OK** button to confirm.



3. Press the **Menu** button to return to the previous menu. Press the **Exit** button to exit the menu.

Sound Setting

Allows you to select an audio-enhancement technique.

1. Press the **Menu** button and then press the **▲▼** buttons to select the **SOUND** menu.
2. Press the **OK** or **▶** buttons and then press the **▲▼** buttons to select the following sound options and then press the **OK** button.

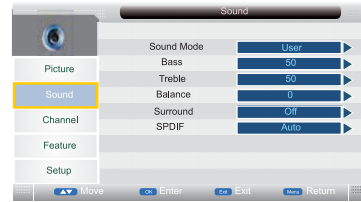

Sound Mode Press the **▲▼** buttons to select an audio-enhancement technique: Standard / Movie / Music / Speech / User and then press the **OK** button to confirm.



Alternative

You may press the **Sound** button once and then press the **◀▶** buttons to select the sound mode.



Bass Press the **◀▶** buttons to control the relative intensity of lower-pitched sounds. (for user mode)

Treble Press the **◀▶** buttons to control the relative intensity of higher pitched sounds. (for user mode)

Balance Press the **◀▶** buttons to adjust the relative volume of the speakers in a multiple speaker system.

Surround Press the **▲▼** buttons to turn on / off the surround function by selecting "On" or "Off".

SPDIF Press the **▲▼** buttons to select among Off, PCM, Auto and Multi .

3. Press the **Menu** button to return to the previous menu. Press the **Exit** button to exit the menu.

Stereo / Dual Sound Reception (ATV Mode)

When a programme is selected, press the **Sound** button twice and then press the **◀▶** buttons to select **Mono / Nicam Stereo** for the selected station.

Broadcast	On Screen Display
Mono	MONO
Stereo	NICAM STEREO

Mono sound selection

If the stereo signal is weak in stereo reception, you can switch to mono by pressing the **Sound** button twice and then press the **◀▶** buttons to select **Mono / Nicam Stereo**. In mono reception, the clarity of sound is improved. To switch back to stereo, press the **Sound** button twice and then press the **◀▶** buttons to select **Mono / Nicam Stereo** again.

Speaker Sound Output Selection (DTV Mode)

While watching a DTV programme, you can press the **Sound** button to display the audio language list (only applicable when the TV programme has this feature).

Press the **▲▼** buttons to select an audio language or audio format if available and then press the **◀▶** buttons to select sound track between Left, Right and Stereo. Press the **OK** button to confirm and exit.



Channel Setting (TV, DTV or Radio Mode)

Allows you to set up a variety of channel options.

1. Press the **Menu** button and then press the **▲▼** buttons to select the **CHANNEL** menu.
2. Press the **OK** and then press the **▲▼** buttons to select the following channel options and then press the **OK** button.



Channel Management

To manage (Delete / Rename /Move / Lock / Skip) all channels.

1. Press the **▲▼** buttons to **Channel Managemen** then press the **OK** button to confirm.
2. A channel management screen will pop up, Press the **▲▼** buttons to select the channel you want to edit.

a. Delete

Press the **RED** button to delete the selected channel.

b. Lock

Press the **GREEN** button to lock your selected channel (The ticked Channels will only be locked when the LOCK option in the FEATURE menu is set to ON)

c. Skip

Press the **YELLOW** button to select the channels that you want to skip when you are selecting channels. Press the **YELLOW** button again to undo it.

d. Move

Press the **BLUE** button and then press the **▲▼** buttons to move to the selected position .Press the **BLUE** button to confirm.

3. Press the **Menu** button to return back to the main menu.
4. Press the **Exit** button to exit the menu.



Favorite Management

To manage (Add / Delete) favorite channels.

1. Press the **▲▼** buttons to Favorite Management then press the OK button to confirm.
2. A favorite management screen will pop up.
3. Press the **▲▼** buttons to select the channels to be added to your favorite lists, press the **RED** button to add to FAV list 1. **GREEN** button FAV list 2. **YELLOW** button FAV list 3 or **BLUE** button for FAV list 4.

4. Press the **Menu** button to return back to the main menu.
5. Press the **Exit** button to exit the menu.



Channel Setting (TV, DTV or Radio Mode)

Country

Press the ▲▼ buttons to select the country and then press the **OK** button to confirm.

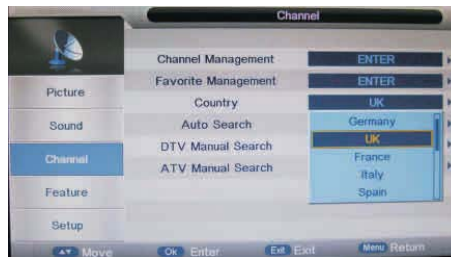

TV Connection

Select DTV type, you can choose Freeview, Cable as you like.

Auto Search

To select auto search mode (All / Digital / Analogue).

1. Press the ▲▼ buttons to **Auto Search** then press the **OK** button to confirm.
2. Select Auto Search item to enter auto search user operation interface as following.



All Mode: Select **All** to scan all available DTV and ATV channels and store them. To skip the ATV search press the Menu button. To exit the Tuning menu press EXIT.

DTV Mode: Select **Digital** to scan all available DTV (Freeview) channels and store them.



ATV Mode: Select **ATV** to scan all available Analogue Channels and store them. (This option is not available for UK). To exit the tuning menu press EXIT.

3. Press the **Menu** button to return back to the main menu.
4. Press the **Exit** button to exit the menu.

Channel Setting (TV, DTV or Radio Mode)

DTV Manual Search

How to search Digital channels manually.

1. Select **DTV Manual Search**, press the OK button to confirm.
2. Select a channel number by pressing the ► button or by using the number buttons on the remote control. The Strength and Quality of the signal indication bars are below.
3. Select **Start** to begin the search.
4. To exit the tuning menu press EXIT.



ATV Manual Search

To search analogue channel by entering parameters manually.

1. Press the ▲▼ buttons to **ATV Manual Search** then press the **OK** button to confirm.
2. Select ATV manual search item to enter air channel manual search in ATV source and the user operation interface as following.

Current Channe	Displays the current channel number.
Frequency	Select AFC On to lock the desired frequency.
Search	Press the ◀▶ buttons to start the manual tuning.
Fine-Tune	Press the ◀▶ buttons to make manual fine tuning adjustments.
Color System	Selects the color system: Auto / SECAM / PAL.
Sound System	Selects the sound system: BG / DK / I / L / L' .



3. Press the **Menu** button to return back to the main menu.
4. Press the **Exit** button to exit the menu.

Feature Setting

Allows you to set up a variety of feature options.

1. Press the **Menu** button and then press the **▲▼** buttons to select the **FEATURE** menu.
2. Press the **OK** or **▶** buttons and then press the **▲▼** buttons to select the following feature options and then press the **OK** button.



Lock

1. Press the **▲▼** buttons to **Lock** then press the **OK** button to confirm.
2. Use the **0-9** buttons to input a 4-digit password to enter the **LOCK** menu and then press the **OK** button to turn the Lock System **On**.



- The default password is "0000".
- If you change the password, be sure to remember the new password! If you forget the new password, press the master password "8899".

Lock Channel: ON: Turns on the Lock options. (This option must be set to ON for the channel management Lock option to function) Once the Lock option is activated (ON). To view any locked channels you will need to give a password. For Auto, Manual tune and TV reset a password will also be needed.
OFF: Turn off the LOCK options. (All functions of the TV will be available)

Parental Guidance: Off: turn off Parental Lock
4-18: turn on Parental Lock and set the age level that are permitted to watch the program.

Change Pin Code: Press the **OK** or **▶** buttons to enter the pin code changing page.

Hotel Mode: Enter the Hotel Setting menu.

3. Press the **Menu** button to return back to the main menu.
4. Press the **Exit** button to exit the menu.

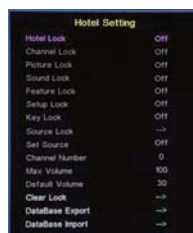

Language

System language setting, includes OSD Language, Preferred Subtitle, Preferred Audio, Digital Teletext Language, Anglog Teletext Language.

1. Press the **▲▼** buttons to **Language** then press the **OK** button to confirm.

- OSD Language** Press the **◀▶** buttons to select the menu language.
- 1st/2nd Preferred Subtitle** Press the **◀▶** buttons to select the Preferred Subtitle.
- 1st/2nd Preferred Audio** Press the **◀▶** buttons to select the Preferred Audio.
- DTV Teletext Language** Press the **◀▶** buttons to select the DTV Teletext Language.
- ATV Teletext Language** Press the **◀▶** buttons to select the ATV Teletext Language.

3. Press the **Menu** button to return back to the main menu.
4. Press the **Exit** button to exit the menu.

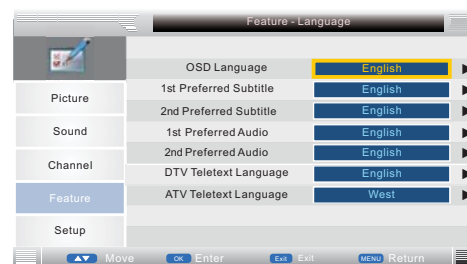

Feature Setting

Clock

Allows you to adjust timer zone, sleep timer, auto standby, OSD timer and summer time.

1. Press the ▲▼ buttons to **Clock** then press the **OK** button to confirm.

Date Press the OK buttons to set date.
Time Press the OK buttons to set time.
(The Date and Time option are not available in UK. The Time and Date are automatically set by the Digital TV signal.)

Time Zone When you select a Time Zone city, the TV time is set by the time offset information based on Time Zone and GMT (Greenwich Mean Time) which is received with the broadcast signal and the time is set automatically by a digital signal.
Press the ◀▲▼▶ buttons to select the desired time zone city and then press the **OK** button to confirm. (DTV mode)

DST (daylight saving time) [On, Off] if it's **On**, it'll be an hour earlier than the GMT. If Time Zone is set to **Auto**, it's not available.



Sleep Timer The sleep timer automatically switches the TV to standby after the preset time has elapsed. The clock will be set automatically when receiving a digital signal. Time must be set before using Sleep Timer function.

Press the ▲▼ buttons to select a period of time after which the TV automatically switches to standby mode: OFF / 10 / 20 / ... / 180 / 240 min and then press the **OK** button to confirm. The timer begins to count down from the number of minutes selected.



If you turn the TV off after setting the sleep timer, the sleep timer setting will be erased.

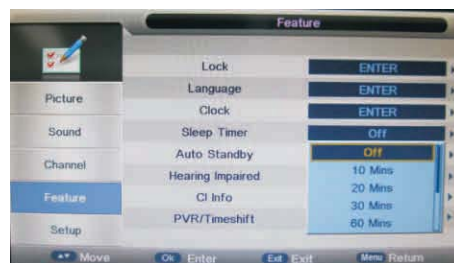

Auto Standby

The unit will automatically switch to standby mode 1, 2 or 4 hours after the last time the remote control was used. A reminder screen will pop up and count down before the unit switches to standby mode. If you want to operate the TV for a long period of time, turn off the auto standby function by selecting Never.

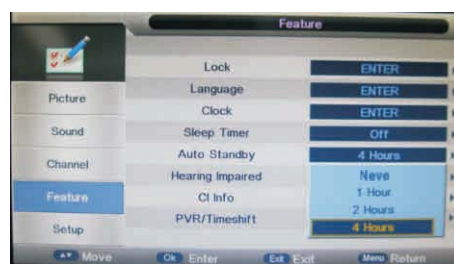

Hearing Impaired

Allows you to show more information in subtitles for the hearing-impaired in some programmes (for DTV channels only if available).

1. Press the ▲▼ buttons to select **Hearing Impaired** and then press the **OK** button to select **On / Off** and return to the previous menu.
2. Press the **Menu** button to return to the previous menu. Press the **Exit** button to exit the menu.



Feature Setting

CI (Common Interface) (DTV Mode)

The common interface allows the use of a Common Access Module to enable you to view scrambled (pay to view) services. These services are provided by TopUp TV (UK only) and others. The Common Access Module and viewing card can be obtained from the service provider.



Do not repeatedly insert or remove the Common Access Module as this may damage the interface and cause a malfunction.

This feature is not available in all countries.

To insert the Common Access Module

1. Before you insert the Common Access Module, ensure that the TV is switched off and the viewing card is inserted **in accordance with the Service Provider's instructions**.
2. Insert the Common Access Module into the slot. Flip the Common Access Module to another side and try again if you feel resistance.
3. Switch the TV on.

To remove the Common Access Module

1. Before you remove the Common Access Module, ensure that the TV is switched off.
2. Pull the Common Access Module from the slot.
3. Switch the TV on.

To view the module information

1. Press the ▲▼ buttons to **CI Info** then press the **OK** button to confirm.
2. A CI Information Main menu will pop up. Press the ▲▼ buttons to display the module information, smart card information, language, software download. Press the **OK** button to confirm.
3. After finishing the manual tuning adjustment of a channel, press the **Menu** button to save your channel before tuning the next channel.
4. Press the **Exit** button to exit the menu.

Rear View of TV

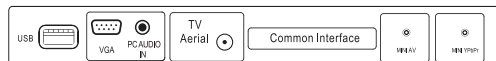

CI (Common Interface)

Allows the Common Access Module to be inserted and access the content that has been encrypted.

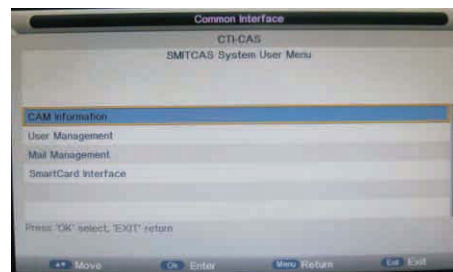
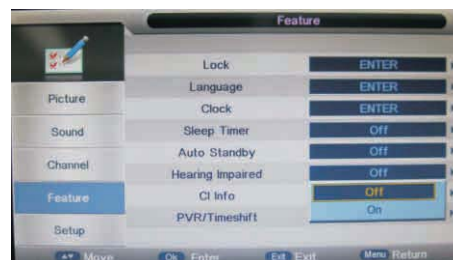
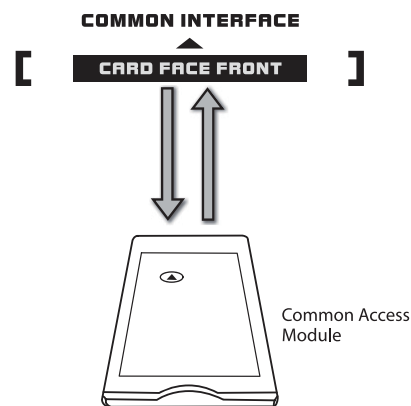

This screen is for illustration only.

Feature Setting

PVR/Time shift(DTV Mode)

Allows you to select your preferences in the PVR/Time shift

1. Press the ▲▼ buttons to select PVR/Time shift then press the **OK** button to confirm.

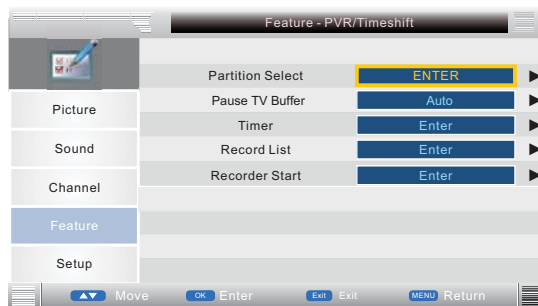

Partition Select

Press the **OK** buttons to select the Partition Select menu. Display partition's information / Format partition function / Set default partition function.

Partitions The list in the menu shows the partitions connected to system.

Partitions' property Total size and Free size.

Format Partition Press **RED** button to format the displayed partition.

Set default partition If more partitions are displayed press the **GREEN** button to select the default partition.



Pause TV Buffer

Press the ◀▶ buttons to select the Auto Time shift. choose from Auto / 30mins / 1hr / 2 hr.

Timer

Press the **OK** button to select the Timer menu.

CH NO. Channel number.
Channel Channel name.
Start Start recording time.
Duration The total recording time.
Date The date the recording started.
Mode Record Mode.
 On the left top of menu is current date and time .



Record List

The **Record list** shows all previous recordings on the inserted USB storage device.



Recorder Start

Start an instant record by selecting **OK**

Setup Setting

Allows you to set up a variety of setup options.

1. Press the **Menu** button and then press the **▲▼** buttons to select the **Setup** menu.
2. Press the **OK** or **▶** buttons and then press the **▲▼** buttons to select the following setup options and then press the **OK** button.



OSD Time Press the **▲▼** buttons to select the display time of the on-screen menu: 5s / 10s / 15s / 20s / 25s / 30s / Never and then press the **OK** button to confirm.

PC Setup (PC mode only) Press the **OK** button to enter the submenu to adjust the Horizontal/Vertical position or Size and Phase of the picture.



Home Mode Press the **▲▼** buttons to select the Home Mode: Max Brightness / Home / Max Economy and then press the **OK** button.

Software Upgrade: For technical service and repair only.

OTA Upgrade

Factory Reset: Reset all factory default settings and delete all channels.



Reset TV Setting

Restores all settings to the factory defaults.

1. Press the **Menu** button then press the **◀▶** buttons to select the **SETUP** menu.
2. Press the **▲▼** buttons to select **Reset TV Setting** and then press the **OK** button.
3. When activated the factory default settings will be applied to all user settings. (No Channels will be lost)

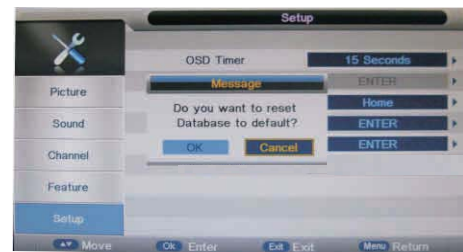

3. Press the **Menu** button to return to the previous menu. Press the **Exit** button to exit the menu.

EPG (Electronic Programme Guide) (DTV Mode)

This system has an Electronic Programme Guide (EPG) to help you navigate through all the possible viewing options.

The EPG supplies information such as programme listings, start and end times for all available services. In addition, detailed information about the programme is often available in the EPG (the availability and amount of programme information will vary, depending on the particular broadcaster).

This function can be used only when the EPG information is broadcast by broadcasting companies.

The EPG displays the programme details for the next 7 days.

Switch On / Off EPG

1. Press the **EPG** button to switch on EPG.
2. Press the **EPG** button or the **Exit** button again to switch off EPG and return to normal TV viewing.

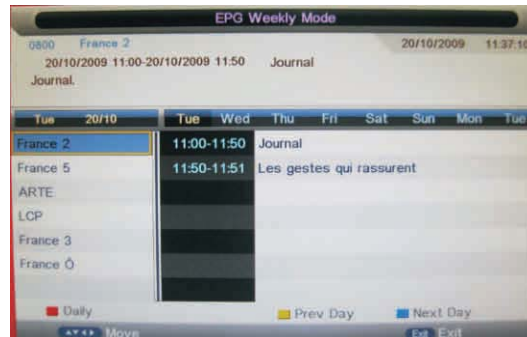

There are 3 modes of EPG menu :

Daily mode: shows the information of the programs to be broadcasted in daily mode.

- RED** (Weekly) Change to weekly mode.
- GREEN** (Reminder)
- YELLOW** (Prev Day) Update the program information of the current 7 channels in the channel list to the previous day and the start time keeps the same.
- BLUE** (Next Day) Update the program information of the current 7 channels in the channel list to the next day and the start time keeps the same.

Weekly mode: shows the information of the programs to be broadcasted in weekly mode.

- RED** (Daily) Change to Daily mode.
- YELLOW** (Prev Day) If the cursor lies on the right event list, update the right event list to display the event information of the previous day and move the cursor to the same place in the updated page.
- BLUE** (Next Day) If the cursor lies on the right event list, update the right event list to display the event information of the next day and move the cursor to the same place in the updated page.

Extended mode: shows the detailed information of each program. Extended detailed programme information can be displayed by pressing the info button on the remote control.

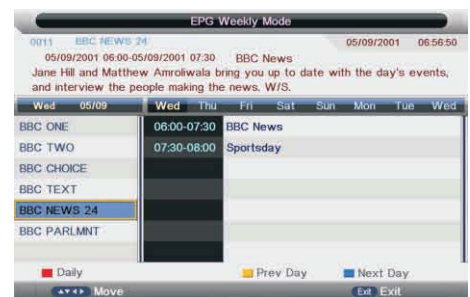

Teletext (ATV Mode)

Teletext is a free service broadcast by some TV stations which gives up-to-the-minute information on news, weather, television programmes, share prices and many other topics. Using the Teletext control buttons you can view pages of information that are listed in the teletext index.

To Turn on Teletext Function



Make sure the TV channel you are watching transmits teletext.
"No Teletext" sign will show on the screen if teletext is not available.

In ATV mode, press the **TEXT** button to enter Teletext mode.

Press the **TEXT** button three times to exit and the TV will return to the channel you were watching.

To select a page of text

Find the number of the page in the index and enter it using the **0-9** buttons. The number of the page will appear on the top left corner of the screen.

The page counter will search for your page. When it finds it, the page will be displayed.

To move to the next page of text, press the **▲** button.

To move to the previous page, press the **▼** button.

Mix

To view a page of text while watching a TV programme, press the **TEXT** button twice. The text will be superimposed over the TV programme.

Fasttext

At the bottom of the teletext screen is a row of subject headings in red, green, yellow and blue.

The remote control has a row of colour buttons corresponding to the row of coloured subjects on the screen.

Pressing one of the colour buttons will take you directly to the page corresponding to the subject heading.

Digital Teletext (DTV Mode)

Digital teletext can access special digital teletext services and specific services which broadcast digital teletext. You will need to turn off **Subtitle Function** before using teletext.

Teletext within Digital Service

1. Press the **TEXT** button to display the teletext page. If no Teletext service is available, a "No Teletext" message will be displayed.
2. Press the **0-9** buttons to select a page number.
3. Follow the instructions on digital teletext and move onto the next step by pressing **OK**, **▲**, **▶**, **▼**, **RED**, **GREEN**, **YELLOW**, **BLUE** or **0-9** buttons etc.
4. To change digital teletext service, select a different service by pressing the **0-9** buttons or the **▲**/**▼** buttons.



Alternative

You may press the **RED** button to the **TEXT** button to display the teletext information when you see a ● red logo displayed on the screen (e.g. BBC).

5. Press the **TEXT** button to exit.

Connecting a USB Storage Device

1. Switch off the TV before connecting any USB storage device.
2. Connect your USB storage device to the USB port of your TV.
3. Plug the connected devices into the mains socket
4. Press the **STANDBY** button on of the TV or the **⏻** button on the remote control to turn on your TV.
5. Press the **SOURCE** button on the TV or the **SOURCE** button on the remote control to display the Source List. Use the **▲▼** buttons to select **Media** and then press the **OK** button to confirm.

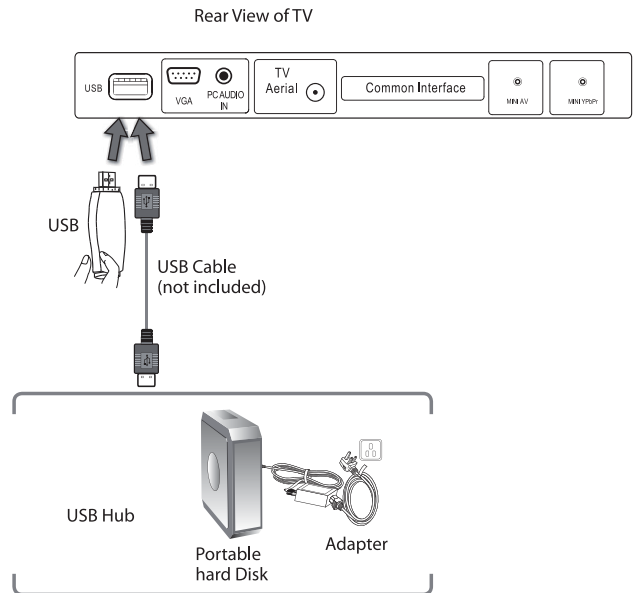

- If a hard disk is used, make sure its mains adapter is connected to the mains supply.
- If a USB hub is used, make sure its mains adapter is connected to the mains supply as the total current consumption may exceed 500mA.
- The maximum supported storage space of the hard disk is 1 TB.
- The file system only supports HiSpeed FS, FAT16, FAT32, NTFS formats (NTFS Compressed files are not supported).
- If you want to store the video streaming of a DTV programme, the transfer rate of the USB storage device must not be less than 5MB/s, otherwise the picture and sound of the programme will be affected and a warning statement will be shown on the screen. If this happens, please upgrade your USB storage device.
- The TV screen will be blank temporarily as it will take time to start up and stabilise the connected hard disk. This is normal and the starting time may vary depending on the brand and the memory size of the connected hard disk.
- Disconnect the USB storage device if it is not in use.
- USB output: DC 5V  500mA

Viewing Photos

1. Press the **SOURCE** button on the TV or the **SOURCE** button on the remote control then press the **▲▼** buttons to select the **Media** mode and then press the **OK** button to display the root menu.
2. Press the **◀▶** buttons to select **PHOTO** and then press the **OK** button.
3. Press the **◀▶** buttons to select your storage device and then press the **OK** button.



File format supported: JPG / JPEG / BMP / PNG / GIF / TIFF.

4. Press the **▲▼** buttons to navigate in the picture folder and then press the **OK** button. Select the picture file and then press the **▶** button to view. If you need to delete the file, press the **RED** button and then press the **◀** button to confirm.

5. Press the **Info** button or the **OK** button to display the function bar. Press the **◀▶** buttons and then press the **OK** button to select the function: Play / Pause / Stop / Prev. / Next / Rotate / Zoom / Info / Photo Setup / Play list.



If this folder also contains music files. You can select a music track to play at the same time while viewing your photo.

6. Press the **Exit** button to return back to the previous menu and to select another file to play. Press the **Exit** button repeatedly to return to the root menu.

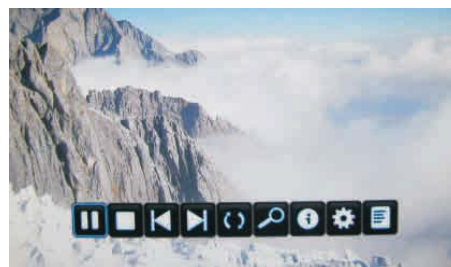
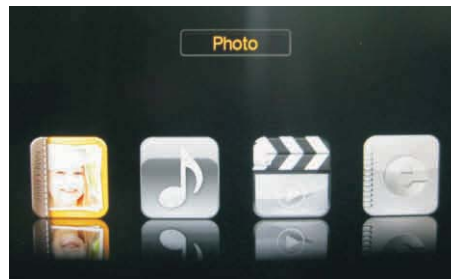

Listening to Music

1. Press the **SOURCE** button on the TV or the **SOURCE** button on the remote control then press the **▲▼** buttons to select the **Media** mode and then press the **OK** button to display the functions bar.
2. Press the **◀▶** buttons to select **MUSIC** and then press the **OK** button.

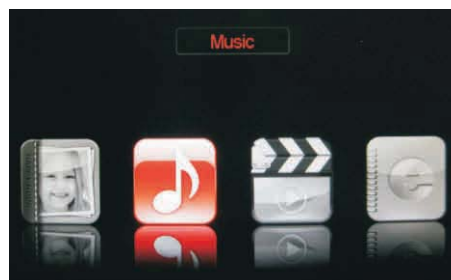

- Press the ◀▶ buttons to select your storage device and then press the **OK** button.



- Press the ▲▼ buttons to navigate in the music folder and then press the **OK** button. Select the music you want to play and then press the ▶ button to play it. If you need to delete the file, press the **RED** button and then press the ◀ button to confirm.



- Some audio file formats will not be supported.
- Supported file formats: WAVE / WMA / AAC / AC3 / MPEG.



- Select the music you want to play, it will show the music information (Album / Title / Bit Rate / Artist / Sampling / Year / Size).
- Press the ◀▶ buttons and then press the **OK** button to select the function: Play / Pause / Stop / FB / FF / Prev. / Next / Goto Time / Repeat All / Play list / Music.
- Press the **Exit** button to return back to the previous menu and to select another file to play. Press the **Exit** button repeatedly to return to the root menu.



Watching Movies

- Press the **SOURCE** button on the TV or the **Source** button on the remote control then press the ▲▼ buttons to select the **Media** mode and then Press the **OK** button to display the root menu.
- Press the ◀▶ buttons to select **MOVIE** and then press the **OK** button.

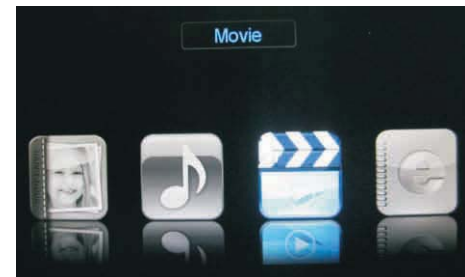

- Press the ▲▼ buttons to select your storage device and then press the **OK** button.



- Press the ▲▼ buttons to navigate in the movie folder. Select the movie file and then press the ▶ button to view. If you need to delete the file, press the **RED** button and then press the ◀ button to confirm.



- Some audio file formats will not be supported.
- Supported file formats: AVI / MPEG1/2 / MPEG4 / WMV / H.264.

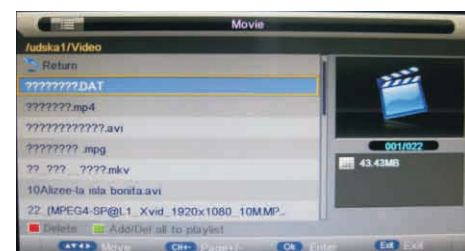



5. Press the **Info** button or the **OK** button to display the function bar. Press the ◀▶ buttons and then press the **OK** button to select the function: Play / Pause / Stop / FB / FF / Slow mode / Step mode / Repeat A-B / Prev. / Next / Play list / Info / Movie Setup / Goto Time.
6. Press the **Exit** button to return back to the previous menu and to select another file to play. Press the **Exit** button repeatedly to return to the root menu.

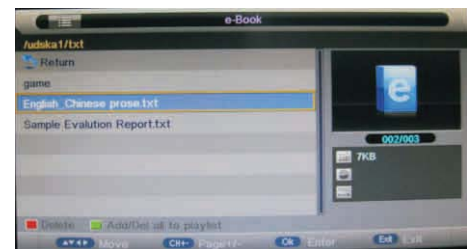
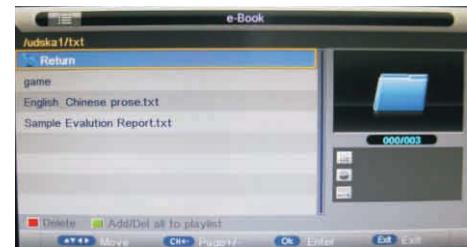
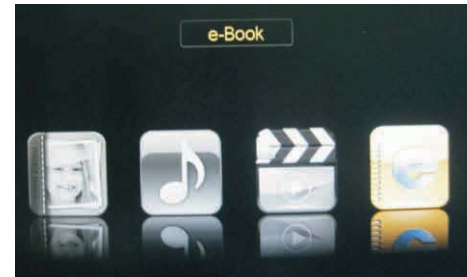

Viewing Texts

1. Press the **SOURCE** button on the TV or the **Source** button on the remote control then press the ▲▼ buttons to select the **Media** mode and then press the **OK** button to display the root menu.
2. Press the ◀▶ buttons to select **TEXT** and then press the **OK** button.
3. Press the ◀▶ buttons to select your storage device and then press the **OK** button.
4. Press the ▲▼ buttons to navigate in the text folder. Select the text file and then press the ▶ button to view. If you need to delete the file, press the RED button and then press the ◀ button to confirm.
5. Press the **Info** button or the **OK** button to display the function bar. Press the ◀▶ buttons and then press the **OK** button to select the
6. Press the **Exit** button to return back to the previous menu and to select another file to play. Press the **Exit** button repeatedly to return to the root menu.



 If this folder also contains music files. You can select a music track to play at the same time while viewing your text.

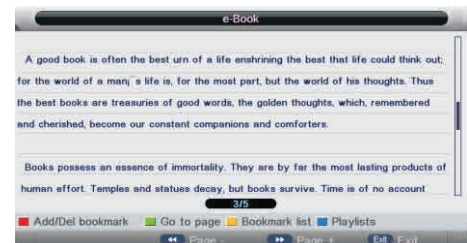

Time Shift Function (DTV Mode)

This function allows the TV to virtually record the live viewing broadcast programme.



- Time Shift Mode and Recording functions may not work if the signal strength is weak.
- Stop the time-shift function before switching to another input source.



If the transfer rate of the USB storage device is too slow for recording or time shift function, a warning statement will be shown on the screen. If this happens, please upgrade your USB storage device.

During normal TV viewing, you may press the **▶** button to virtually pause the live viewing broadcast programme if you want to go out for a while (e.g. going to the bathroom / kitchen). "||" will show on the screen.

There may be a few seconds delay in video and sound when the unit starts to playback the missed broadcast programme. It will return to normal.

Time shift input info menu:

Information Time shift input info menu displays as a flag of Time shift. After Time shift start this menu displays all the time until. Time shift stop (except there is some other menu exist) .

Enter method After Time shift start, it will display automatically.

Time shift info banner menu:

Information Time shift info banner shows some current Time shift information.

Enter method After Time shift start, press Info to show the menu .

Function explain :

- Time is equal to current play time minus current recording time.
- Progress bar is for current recording length compared with the disk free space when REC start. The black triangular icon is for current play length compared with current recording length.
- MB Free is the disk instantaneous free space.
- The right red time menu has the same function with the time in info banner menu(only when info banner menu closed it showed).



Time shift time menu



Time shift info menu

Recording DTV Programme onto a USB Storage Device

Use this function to record the DTV programme you are watching on the main screen and save them for future viewing.

Make sure that your connected USB storage device has enough available memory space.

1. Press the **Rec** button to record the programme that you are currently watching.



REC info menu



The recording progress bar will disappear after 15 seconds. To display the recording progress bar again, press the **OK** button or the **Rec** button.

2. Press the **■ Stop** button to stop recording.



Recording will stop automatically when the disk is full.

Timer Programming

This function is used to perform scheduled recording.

1. Press the **Timer** button on the remote control.
The **Timer** menu will appear.



2. Press the **ADD** button enter the Time Edit menu for the channel.

Recorder Press the ▲▼ buttons to select the Recorder On or Off.

Type Press the ▲▼ buttons to select the Type

Channel Press the ▲▼ buttons to select the

Start time Press the ▲▼ buttons to select the Minutes / Hour / Month / Date and then press the ◀▶ buttons to adjust the start time.

Duration Press the ▲▼ buttons to select the Minutes / Hour / Month / Date and then press the ◀▶ buttons to adjust the end time.

Date Press the ▲▼ buttons to select the date of starting recording, Format is day / month / year.

Mode Press the ◀▶ buttons to select the Once / Every Day / Weekly.



3. After finishing all the recorder adjustments, press the **OK** button to confirm your settings. A Timer Save Success screen will display.

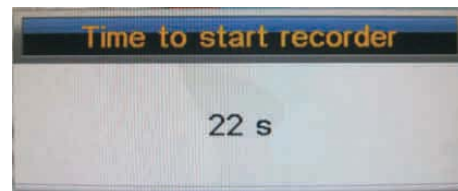

4. The **Schedule List** will then be displayed with your preset reminders shown.
5. Press the **YELLOW** button to return to the EPG.
6. Press the **Exit** button to exit EPG.



- When the preset time is reached, the TV will start recording automatically.
- If a programme recording starts when the TV is in standby mode, the LED indicator will alternately flash red and green.

Play Recorded Programme

You can play a recorded programme from the recorded programme list or from a USB Storage Device.

1. Press the **SOURCE** button on the TV or the **SOURCE** button on the remote control then press the **▲▼** buttons to select the **Media** mode and then press the **OK** button.
2. Press the **◀▶** buttons to select **MOVIE** and then press the **OK** button.
3. Press the **◀▶** buttons to select your storage device and then press the **OK** button.
4. Press the **▲▼** buttons to select the "**PVR**" folder and then press the **OK** button. Press the **▲▼** buttons to navigate in the "**PVR**" folder. Select your recorded programme and then press the **OK** button to view.

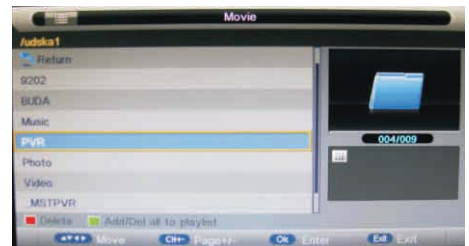
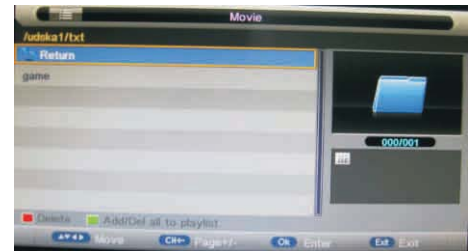

Maintenance

Careful and regular cleaning can prolong the life of your TV.



Be sure to Disconnect the mains cable from the mains socket before any cleaning.

1. Use a soft dry cloth to wipe away the dust from the screen and surfaces.
2. If the surfaces are extremely dirty, clean the TV with a cloth which has been dipped in a weak soapy water. Wring the cloth until it is almost dry, then use it to wipe the TV.
3. Ensure there is no excess water on the screen. Allow any water or dampness to evaporate before switching the TV on.

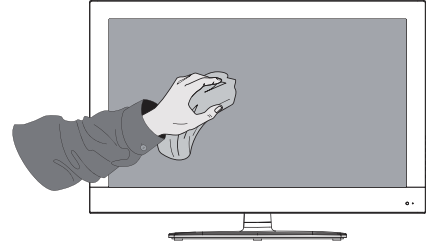

Never use alcohol, benzene, paint-thinner, cleaning fluid or other chemicals. Do not use compressed air to remove dust.

Hints and Tips

The TV does not operate properly.

The TV does not respond when pressing any buttons

- The TV may freeze up during use. Disconnect the mains cable from the mains socket for a few minutes. Reconnect the mains cable and try to operate it again as usual.

TV cannot be switched on

- Check that the TV is connected to the mains supply
- Make sure all connected AV devices are switched off before switching on your TV.

The remote control does not work

- Check to see if there are any objects between the TV and the remote control causing an obstruction. Ensure that you are pointing the remote control directly at the TV.
- Ensure that the batteries are installed with the correct polarity (+ to +, - to -).
- Install new batteries.

Power is suddenly turned off

- Check the power of the TV. The mains supply maybe interrupted.
- Check if the sleep timer is set.
- Check whether the Auto Standby is activated.

The video function does not work.

No Picture & No Sound

- Check whether the TV is switched on.
- Try another channel. The problem may be caused by the broadcaster.

Picture appears slowly after switching on

- This is normal, the image is muted during the TV startup process. Please contact your service centre, if the picture has not appeared after five minutes.

No or poor colour or poor picture

- Adjust the settings in the **PICTURE** menu.
- Try another channel. The problem may be caused by the broadcaster.
- Check if the video cables are connected properly.

Horizontal / Vertical bar or picture shaking

- Check for local interference such as an electrical appliance or power tool.

Poor reception on some channels

- Station or cable channel may be experiencing problems, tune to another station.
- Station signal is weak, reposition the aerial for better reception.
- Check for sources of possible interference.

Lines or streaks in pictures

- Check aerial (Change the position of the aerial.)

No pictures when connecting HDMI

- Check if the input source is **HDMI**.

Picture appears in wrong ratio

- Adjust the **Aspect Ratio** settings in the **PICTURE** menu.
-

The audio function does not work.	
Picture OK but no sound	<ul style="list-style-type: none"> • Press the VOL + / - buttons. • Sound muted? Press the Mute button. • Try another channel. The problem may be caused by the broadcaster.
No output from one of the speakers	<ul style="list-style-type: none"> • Adjust the Balance settings in the SOUND menu.
Unusual sound from Inside the TV	<ul style="list-style-type: none"> • A change in ambient humidity or temperature may result in an unusual noise when the TV is switched on or off and does not indicate a fault with the TV.
No sound when connecting HDMI	<ul style="list-style-type: none"> • Check if the input source is HDMI.
Audio noise	<ul style="list-style-type: none"> • Keep the RF coaxial cable away from the other connected cables.
Password	
Lost Password	<ul style="list-style-type: none"> • Select the Change Pin Code setting in the FEATURE menu, then enter the following master password "8899". The master password clears your previous password and allows you to enter a new password.
There is a problem in PC mode.	
The signal is out of range (Invalid format)	<ul style="list-style-type: none"> • Adjust the resolution, horizontal frequency, or vertical frequency.
Vertical bar or stripe on background & Horizontal Noise & Incorrect position	<ul style="list-style-type: none"> • Use Auto configure or adjust clock, phase, or H/V position.
Screen colour is unstable or single colour	<ul style="list-style-type: none"> • Check the signal cable. • Reinstall the PC video card.
FAQs (Frequently Asked Questions)	
Why have I lost some / all of my channels?	<ul style="list-style-type: none"> • It happens sometimes, if you have a weak signal. Usually it just means you'll need to rescan your digital box or TV. Don't worry, it's easy to do. And once you've done it, you should get all the Freeview channels available to you. If problems persist you may need to get your aerial checked. Talk to your retailer or contact your local aerial installer.
Why do I get 'blocking' on my digital picture?	<ul style="list-style-type: none"> • In most cases, blocking is caused by a reception problem – either the signal is too weak or there is some kind of interference. Talk to your retailer or contact your local aerial installer. • Blocking can also be caused by a digital signal that is too strong. If you are still experiencing blocking and the signal is strong, consult your local aerial installer for advice.
Can I watch Freeview using a portable set-top aerial?	<ul style="list-style-type: none"> • Some, but only a few, homes may be able to use a set top aerial. However, for a much better reception, we strongly recommend that you use a rooftop aerial. • If you do not have access to a rooftop aerial – for example, if you rent a flat and the aerial is the responsibility of your landlord, or if you're using a second TV in the bedroom and don't want the hassle and expense of using extension cables, a set – top aerial may be your only option.
What type of aerial do I need?	<ul style="list-style-type: none"> • If you are installing a new aerial, we recommend a wideband rooftop aerial rather than a loft aerial. Loft aerials generally receive a weaker digital signal and are more likely to get interference from other electrical devices in the home. We suggest you have an aerial survey done before getting an aerial upgrade. • Talk to your retailer or contact your local aerial installer.

Display Modes

The screen resolution has been optimised during production for the display modes listed below.

YPbPr Mode

Resolution	Vertical Frequency (Hz)	Aspect Ratio
480i: 720 x 480	60	4:3 / 16:9 / Zoom1 / Zoom2
480P: 720 x 480		
576i: 720 x 576	50	
576P: 720 x 576		
720P: 1280 x 720	50	
	60	
1080i: 1920 x 1080	50	
	60	
1080P: 1920 x 1080	50	
	60	

PC Mode

Please check the display settings of your computer before connecting to the TV. If the display setting of your computer does not match the TV, there may be no video.

Resolution	Vertical Frequency (Hz)	Aspect Ratio
640 x 480	60	4:3 / 16:9
	72	
	75	
800 x 600	60	
	72	
	75	
1024 x 768	60	
	70	
	75	
1360 x 768	60	
1920 x 1080	60	

HDMI Mode

Resolution	Vertical Frequency (Hz)	Aspect Ratio
480i: 720 x 480	60	4:3 / 16:9 / Zoom1 / Zoom2 / Just Scan
480P: 720 x 480		
576i: 720 x 576	50	
576P: 720 x 576		
720P: 1280 x 720	50	
	60	
1080i: 1920 x 1080	50	
	60	
1080P: 1920 x 1080	50	
	60	

Specifications

Model	C50223DVB-LED Ver2
Panel System	50 inch LED Panel
Display Resolution	1920 (H) x 1080 (V) pixels
Television System	PAL / BG / DK / SECAM BG / DK
Brightness	250 cd/m ²
Contrast Ratio	4000:1
Power Source	AC 100-240V~ 50Hz/60Hz
Energy Efficiency Class	A
Screen Size (measured diagonally)	Approx. 127cm(50 inch)
Power Consumption	93 W
Average Annual Energy Consumption	136 kWh
Standby Power Consumption	<0.5 W
Operating Temperature	0°C – 40°C
Vesa Wall mounting size / Screw size	200 x 200mm/M6*14
Speaker Power	10W + 10W
Dimension (W x D x H)without base	1149 x 98 x 685 mm
Dimension (W x D x H) with base	1149 x 260 x 740 mm
Weight (Net)	16 kg

Features and specifications are subject to change without prior notice.

This TV has been tested against the European standards for Energy efficiency using the standard signals and conditions specified in the standard. The result is shown on the energy efficiency label. This is the energy that you would expect the TV to consume under normal working conditions when measured over a period of time. At some times the TV will use more power than this and at some times less. The factors that cause this fluctuation are the actual signals being received, and the Volume setting. Generally speaking the mains voltage, brightness / contrast settings and other settings have a very small effect on energy usage and can to all intense and purposes be ignored. The difference between the power consumed when receiving a high bit rate channel with the volume at max and a low bit rate channel with volume at zero is usually less than 3 watts.

Safety Warnings

- Read all the instructions carefully before using the unit and keep them for future reference.
- Retain the manual. If you pass the unit onto a third party make sure to include this manual.
- Check that the voltage marked on the rating label matches your mains voltage.

Damage

- Please inspect the unit for damage after unpacking.
- Do not continue to operate the unit if you are in any doubt about it working normally, or if it is damaged in any way - switch off, withdraw the mains plug and consult your dealer.

Location of Unit

- The unit must be placed on a flat stable surface and should not be subjected to vibrations.
- Do not place the unit on sloped or unstable surfaces as the unit may fall off or tip over.
- The mains socket must be located near the unit and should be easily accessible.
- This unit is designed for indoor use only.

Temperature

- Avoid extreme degrees of temperature, either hot or cold. Place the unit well away from heat sources such as radiators or gas / electric fires.
- Avoid exposure to direct sunlight and other sources of heat.

Naked Flames

- Never place any type of candle or naked flame on the top of or near the unit.

Moisture

- To reduce the risk of fire, electric shock or product damage, do not expose this unit to rain, moisture, dripping or splashing. No objects filled with liquids, such as vases, should be placed on the unit.
- If you spill any liquid into the unit, it can cause serious damage. Switch it off at the mains immediately. Withdraw the mains plug and consult your dealer.

Ventilation

- To prevent the risk of electric shock or fire hazard due to overheating, ensure that curtains and other materials do not obstruct the ventilation vents.
- Do not install or place this unit in a bookcase, built-in cabinet or in another confined space. Ensure the unit is well ventilated.
- Make sure that there is a gap of at least 10 cm on both sides and a gap of 20 cm at the top.

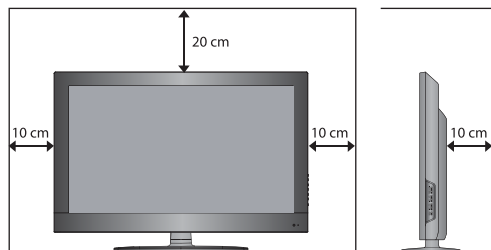

Safety

- Always disconnect the unit from the mains supply before connecting / disconnecting other devices or moving the unit.
- Unplug the unit from the mains socket during a lightning storm.

Mains Cable

- Make sure the unit or unit stand is not resting on top of the mains cable, as the weight of the unit may damage the mains cable and create a safety hazard.
- If the mains cable is damaged it must be replaced by the manufacturer, its service agent, or similarly qualified persons in order to avoid a hazard.

Interference

- Do not place the unit on or near appliances which may cause electromagnetic interference. If you do, it may adversely affect the operating performance of the unit, and cause a distorted picture or sound.

Optimum viewing

- View the unit in moderate light to prevent eye strain. It is recommended to watch the unit from a distance 3-7 times that of the screen height.

LED screen

- The LED screen is manufactured using high-precision technology. However, some tiny black points and / or bright points (red, blue or green in colour) may constantly appear on the LED screen. These points are generated in the manufacturing process and are normal.

Screen Burn

- A characteristic of Plasma and LED TV Panels is that displaying the same image for a long time may cause a permanent after-image to remain on the screen. This is called screen burn. Most pictures shown on the unit will be constantly moving and fill the screen.
- Examples of images that you need to watch out for are as follows (this is not an all-inclusive list):
 1. **Black Bars:** If black bars appear at the left / right or top / bottom of the screen, it is recommended to change the format so that the picture fills the entire screen.
 2. **TV Channel Logos:** e.g. Shopping channel logos and pricing displays - especially if they are bright and stationary. Moving or low-contrast graphics are less likely to cause ageing of the screen.
 3. **Time Displays**
 4. **Teletext:** Do not view a stationary page for long periods of time.
 5. **TV Menus**
 6. **Pause Mode:** Do not leave the screen in pause mode for long periods of time, e.g. when watching videos.
- To prevent screen burn if viewing any of the above for long periods of time, reduce contrast and brightness when viewing. Once burn-in occurs it will never disappear completely.

Headphones

- Listening to loud sounds for prolonged periods of time may permanently damage your hearing.
- Before putting on headphones, turn the volume down then put the headphones on and slowly increase the volume until you reach a comfortable listening level.

Standby

- The  button on the remote control does not switch off the unit completely. The unit will continue to draw electricity from the mains supply while in standby. In the interests of safety and to avoid unnecessary energy consumption, never leave the unit in standby while unattended for long periods of time, e.g. overnight, while on holiday or while out of the house. Switch it off and disconnect the mains plug from the mains socket.

Batteries

- Batteries used in the remote control for this unit are easily swallowed by young children and this is dangerous.
- Keep loose batteries away from young children and make sure that the battery holder tray is secure in the remote control. Seek medical advice if you believe a cell has been swallowed.
- Please dispose of batteries correctly by following the guidance in this manual.

Supervision

- Children should be supervised to ensure that they do not play with the unit and the remote control.
- Never let anyone especially children push anything into the holes, slots or any other openings in the case - this could result in a fatal electric shock.



The lightning flash with arrowhead symbol, within an equilateral triangle, is intended to alert the user to the presence of uninsulated "dangerous voltage" within the unit's enclosure that may be of sufficient magnitude to constitute a risk of electric shock.



The exclamation point within an equilateral triangle is intended to alert the user to the presence of important operating and maintenance (servicing) instructions in the manual accompanying the unit.

Service

- To reduce the risk of electric shock, do not remove screws. The unit does not contain any user-serviceable parts. Please leave all maintenance work to qualified personnel.
- Do not open any fixed covers as this may expose dangerous voltages.

Maintenance

- Ensure to unplug the unit from the mains socket before cleaning.
- Do not use any type of abrasive pad or abrasive cleaning solutions as these may damage the unit's surface.
- Do not use liquids to clean the unit.

Important Note

This TV is fitted with the latest ECO friendly power saving technology. If whilst viewing the TV remote control is not used for a period of 4 hours, the Auto Standby feature will operate and power down the TV. A warning message will be displayed to inform you that the TV is about to power down.



Packaging materials are not toys. Please keep away from children. Plastic bags can cause suffocation when pulled over the head.

Waste Electrical Recycling

Correct disposal of Product



This sign indicates that this product may not be disposed of with your regular household waste. The recycling and separate collection of such products is your responsibility. Please drop off the above mentioned waste at a designated place for recycling waste electrical and electronic equipment. If you do not know where to drop off your waste equipment for recycling, please contact your local city office or household waste collection service.



The crossed out wheeled dust bin symbol indicates that batteries and /or accumulators must be collected and disposed of separately from household waste.

If the battery or accumulator contains more than the specified values of lead (Pb), mercury (Hg), and/or cadmium (Cd) defined in the Battery Directive (2006/66/EC), then the chemicals symbols for lead(Pb), mercury (Hg) and/or cadmium (Cd) will appear below the crossed out wheeled dust bin symbol.



By participating in separate collection of batteries, you will help to assure the proper disposal of products and batteries thus help to prevent potential negative consequences for the environment and human health.

For more detailed information about the collection and recycling programmes available in your country, please contact your local city office or the shop where you purchased this product.



This appliance complies with European Safety and Electrical directives.

It fulfils the following EU regulations:

EN 55022:2006+A1:2007
EN 55013:2001+A1:2003+A2:2006
EN 61000-3-2:2006+A1:2009+A2:2009
EN 61000-3-3:2008
EN 55024:1998+A1:2001+A2:2003
EN 55020:2007