

# LCD digital colour TV

C2275F

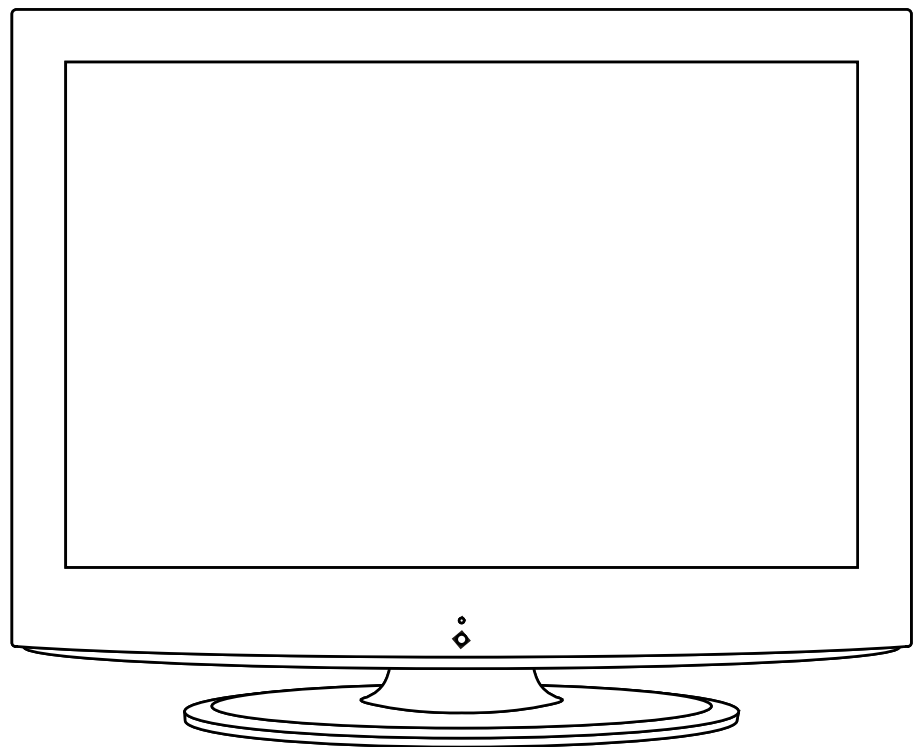

## USER GUIDE

# Introduction

Thank you for purchasing this TV which has been designed and manufactured to give you many years of trouble free service.

You may already be familiar with using a similar product but please take time to read these instructions which have been written to ensure you get the very best from your purchase.

## HDMI

HDMI (High Definition Multimedia Interface) is the next generation of digital interface. Unlike conventional connections, it transmits uncompressed digital and audio signals using a single cable. This TV supports high-definition video input via the HDMI socket on the back of the TV.

## Safety is important

To ensure your safety and the safety of others, please read the safety precautions BEFORE you operate this product.

## Contents

You will find the following

- TV
- User Guide
- Quick Start Guide
- Remote Control
- 2 x AA Batteries

**NOTE:** If any of the items listed are damaged or missing please contact our technical helpline on 0871 288 7345

---

# Contents

<b>1</b>	<b>Introduction</b>
<b>2</b>	<b>Contents</b>
<b>3-5</b>	<b>Safety Information</b>
<hr/>	
<b>6-7</b>	<b>Unit and Accessories</b>
<b>8-11</b>	<b>Remote Control</b>
<b>12</b>	<b>Aerial connection</b>
<b>13-17</b>	<b>Connecting external devices</b>
<b>18</b>	<b>Common Interface slot</b>
<b>19</b>	<b>Auto installation setup</b>
<b>19</b>	<b>Source menu</b>
<b>20-27</b>	<b>Menu settings</b>
<b>28-30</b>	<b>Multimedia Operation</b>
<b>31-33</b>	<b>Recording Operation</b>
<b>34</b>	<b>EPG menu</b>
<b>35-38</b>	<b>DVD Operation</b>
<hr/>	
<b>39</b>	<b>Simple Troubleshooting</b>
<b>40</b>	<b>Technical Specifications</b>
<b>41</b>	<b>Wall Mounting</b>
<hr/>	

---

## SAFETY INFORMATION

*IMPORTANT SAFETY INSTRUCTIONS - READ CAREFULLY BEFORE USE.*

*Take note of the following safety information which appears on the back of the TV.*

---



CAUTION TO PREVENT ELECTRICAL SHOCK, DO NOT REMOVE ANY COVER SCREWS, NO USER SERVICEABLE PARTS INSIDE, REFER SERVICING TO QUALIFIED SERVICE PERSONNEL.

---



This symbol indicates that there are important operating maintenance instructions in the literature accompanying this unit.

---



This symbol indicates that dangerous voltage constituting a risk of electric shock is present within this unit.

---

*Keep these instructions*

- Do not use this TV near water.
  - Clean only with a slightly damp cloth.
  - Do not block any ventilation openings.
  - Install in accordance with the supplied Quick Start Guide and this User Guide.
  - Protect the power chord from being walked on or pinched, particularly at plugs, and the point where it exits from the TV.
  - Do not allow the power chord to overhang the edge of a table.
  - Unplug this TV during lightening storms or when unused for long periods of time.
- 



**WARNING! TO REDUCE THE RISK OF FIRE OR ELECTRICAL SHOCK, DO NOT EXPOSE THIS TV TO RAIN OR MOISTURE. THE TV MUST NOT BE EXPOSED TO DRIPPING AND SPLASHING AND NO OBJECTS FILLED WITH LIQUIDS SHOULD BE PLACED ON THE TV.**

---

NOTE: No naked flames such as candles should be placed on the TV.

---

---

## IMPORTANT SAFETY INFORMATION (Continued)

This unit has been produced according to all current safety regulations. The following safety tips should safeguard users against careless use and the dangers connected with such use.

- Although this appliance has been carefully manufactured and rigorously checked prior leaving the factory, as with all electrical appliances it is possible for problems to develop. If you notice smoke, an excessive build up of heat or any other unexpected phenomena, you should disconnect the plug from the mains power socket immediately.
- Ensure that the unit is sufficiently ventilated! Never place next to or underneath curtains!
- The mains plug or appliance coupler is used as the disconnect device, the disconnect device shall remain readily operable.
- This set should only be connected to a mains power supply which matches that stated on the label on the rear of the TV – do not attempt to connect it to any other type of supply.
- The socket – outlet must be installed near the equipment and easily accessible.
- To prevent overload, don't share the same mains supply socket with too many other items of equipment.
- Apparatus with Class 1 construction shall be connected to a mains socket outlet with a protective earthing connection.
- Keep away from rodents. Rodents enjoy biting into electric flexes.
- Always hold the plug when pulling out the plug from the mains supply socket. Do not pull on the flex, the flex can become overloaded and cause a short circuit.
- Set up the unit so that no one is able to trip over the flex.
- Do not place heavy items on the flex, which may damage it.
- Take note that the flex cannot be reached and pulled by young children, avoiding injury.
- Do not set up the unit near to heat sources. The casing and the flex could be damaged by the impact of heat.
- The screen is made of plastic and can break if damage is done to it. Be careful when collecting sharp edged plastic splinters to avoid injury.
- Avoid placing the unit on any surfaces that may be subject to vibrations or shocks.
- To protect the unit during a thunderstorm unplug the AC power cable and disconnect the aerial. Caution: Do not touch the aerial (RF) connector.
- When you leave your home for long periods of time, unplug the AC power cable for safety reasons.
- The unit becomes warm when in operation. Do not place any covers or blankets on the unit in order to prevent overheating. The ventilation holes are not to be blocked. Do not set up near radiators. Do not place in direct sunshine. When placing on a shelf leave 5 cm (2") free space around the whole unit.
- Do not allow water or moisture to enter the TV. Do NOT use in wet or moist areas such as Bathrooms, steamy kitchens or near swimming pools.
- Do not use this unit when moisture condensation may occur
- Any repairs must be carried out by qualified personnel only.
- Do not open this unit. A non – expert attempting to repair the unit could be dangerous and potentially cause a fire hazard.

---

## **IMPORTANT SAFETY INFORMATION (continued)**

- Liquids spilt into the unit can cause serious damage. Switch the set OFF and disconnect the mains power supply, then consult a qualified service person before attempting to use the unit again.
- Do NOT remove the safety covers. There are no useable or serviceable parts inside. You may invalidate the warranty. Qualified personnel must only service this apparatus.
- Do NOT tap or shake the screen, you may damage the internal circuits. Take good care of the remote control, do not drop.
- Never place hot objects or open flame sources on or close to the TV.
- High temperatures can melt plastic and lead to fires.
- To clean the TV use a soft dry cloth. Do NOT use solvents or petrol based fluids. For stubborn stains, you may use a damp cloth with dilute detergent.

### **Headphone Warning**

Loud music can damage your hearing irreversibly, therefore do not set the volume to a high level when listening through headphones, particularly for lengthy listening periods.

### **Where to install**

Locate the television away from direct sunlight and strong lights, soft indirect lighting is recommended for comfortable viewing. Use curtains or blinds to prevent direct sunlight falling on the screen. Place the TV on a sturdy platform of which the surface should be flat and steady. This will prevent it from falling over.

Make sure the television is located in a position where it cannot be pushed or hit by objects, as pressure will break or damage the screen, and so that small objects cannot be inserted into the ventilation slots or openings in the cabinet.

---

## Unit and Accessories

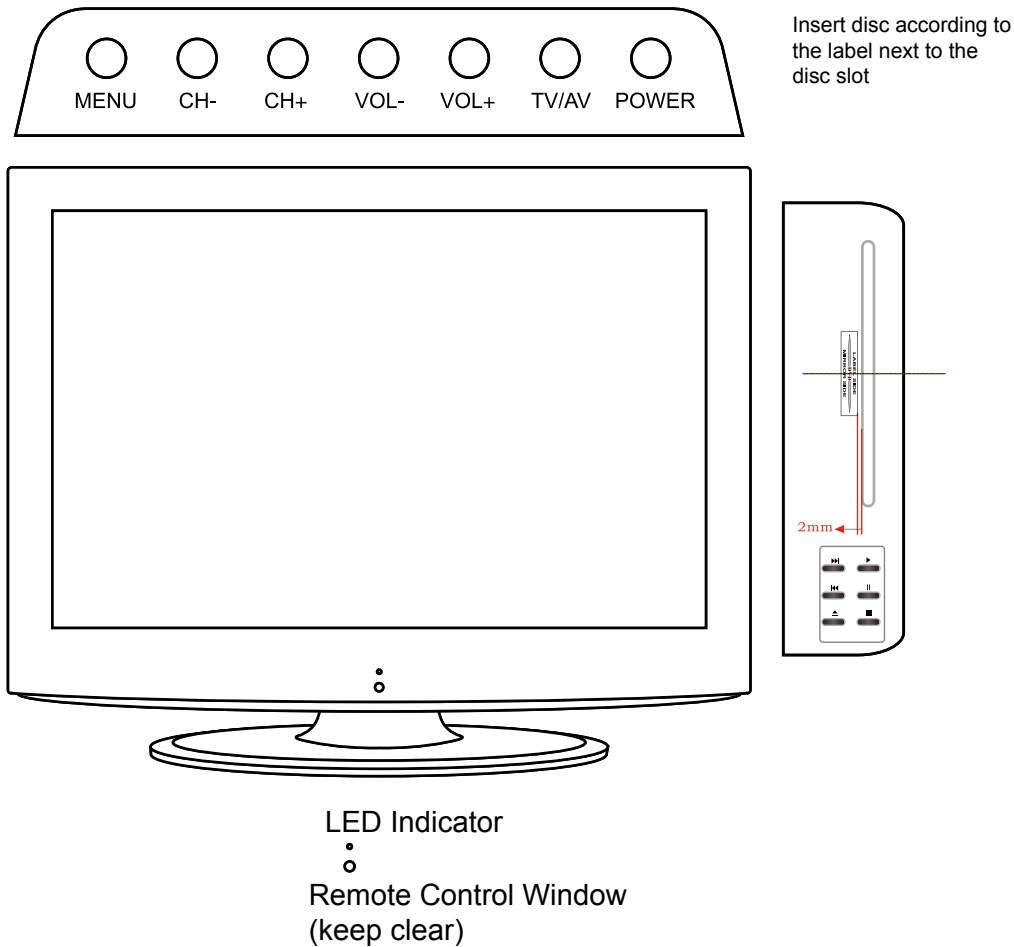

### The functions of the TV buttons are described below.

- Menu** : Press to display the OSD menu, press again to exit the menu.
- CH+/-** : Press to skip through the channels.
- Vol +/-** : Press to adjust the volume.
- TV/AV** : Press to display the input source menu.
- Power** : Turn ON/OFF the TV set.

### The functions of the DVD buttons are described below.

- ▶▶ (NEXT): DVD next chapter.
- ◀◀ (PREV): DVD previous chapter.
- ▲ (EJECT): Load/eject DVD disc.
- ▶ (PLAY): Play DVD program.
- || (PAUSE): pause DVD program.
- (STOP): Stop DVD program.

---

## Unit and Accessories (continued)

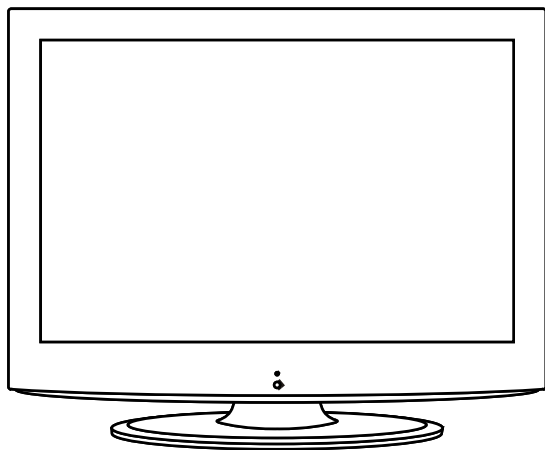

TV set



Remote Control



Batteries



Power cable



Quick Start Guide

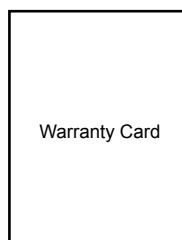

Warranty Card

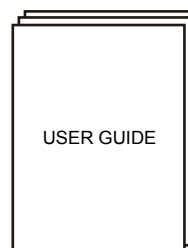

User Guide



---

# Remote control

- Functions of remote control buttons

Dependant on the model of the TV some keys will have no function

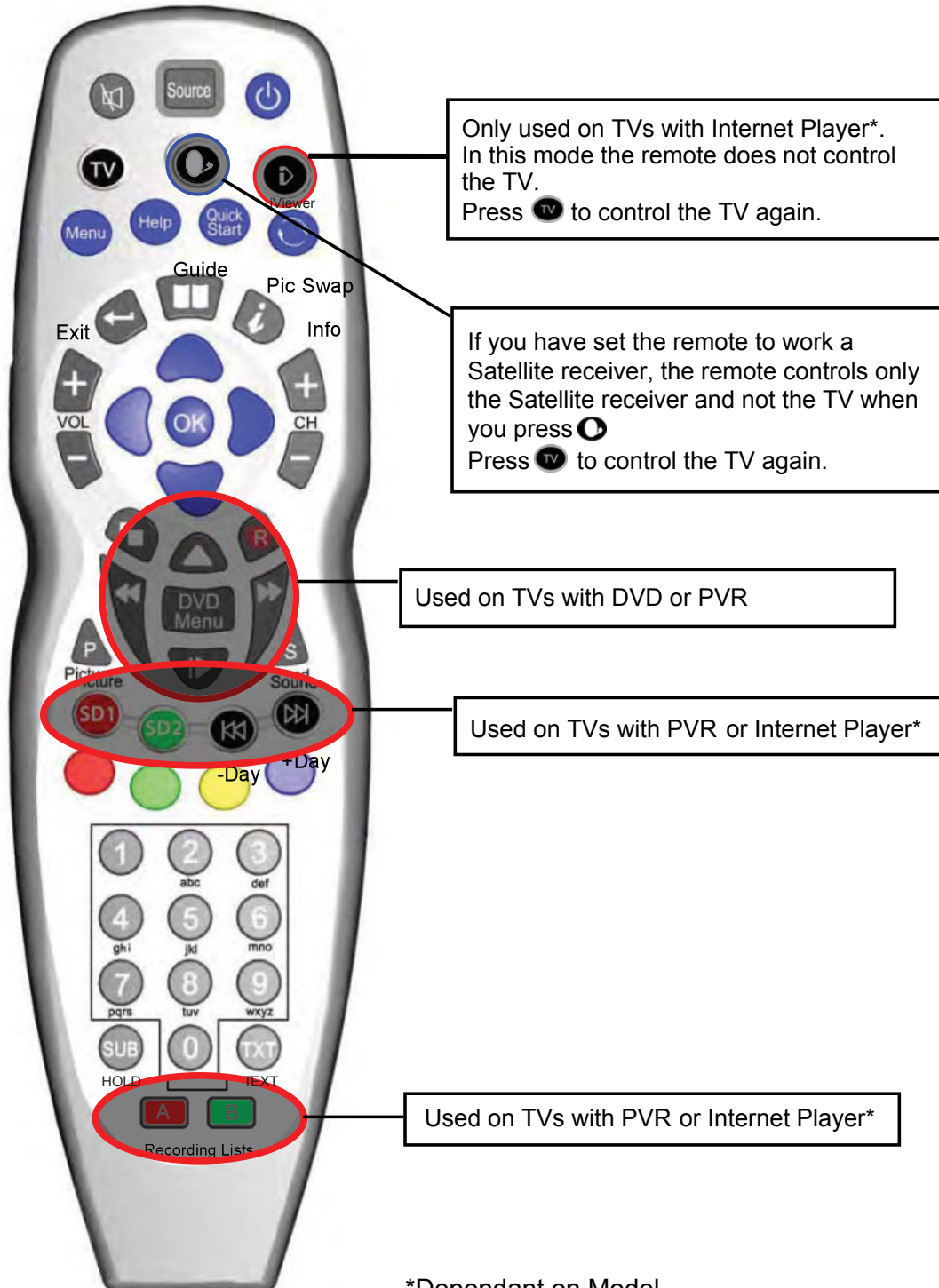

# Remote control (continued)

Dependant on the Model of the TV some keys will have no function

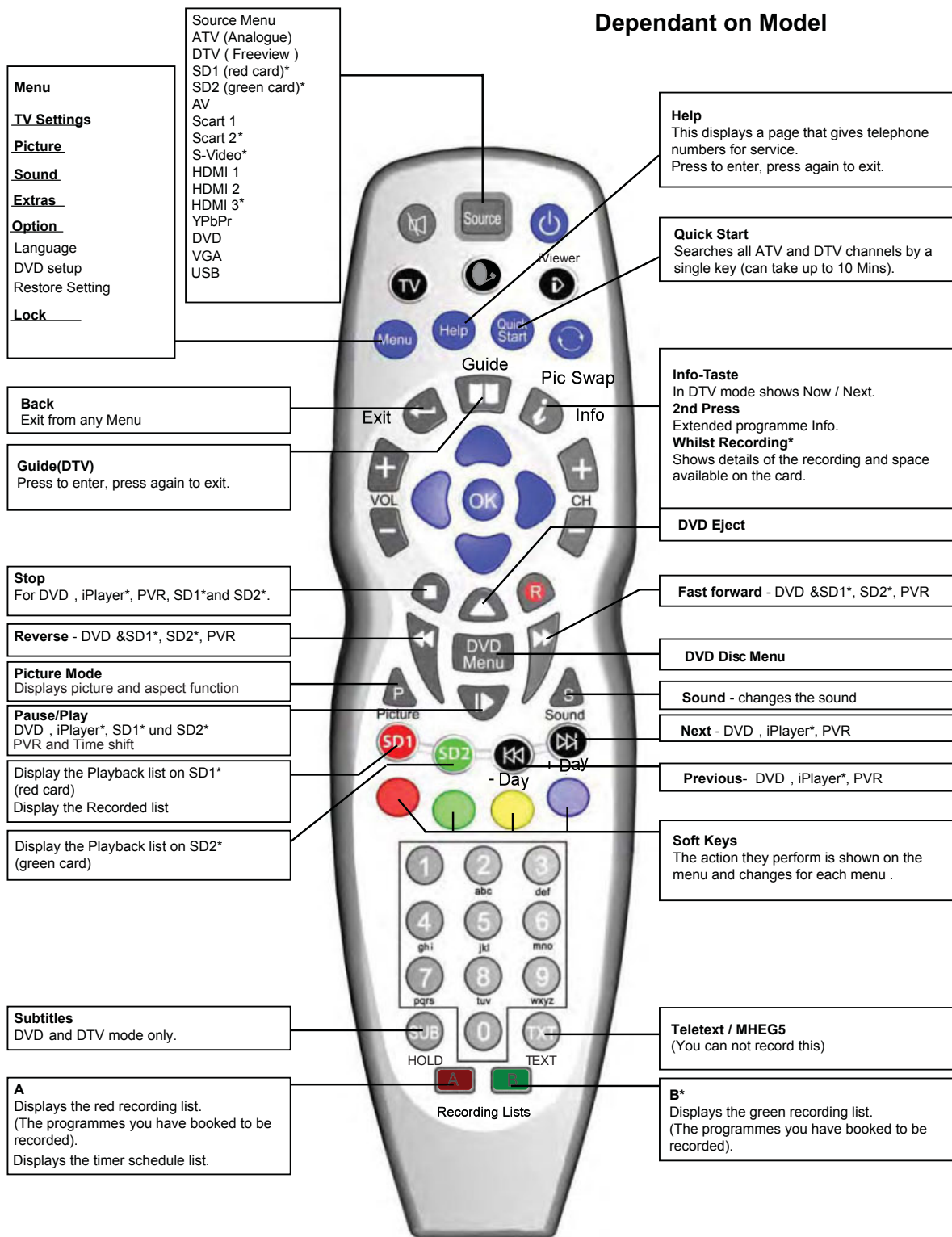

## Remote control (continued)

Dependant on the model of TV some keys will have no function

\*Dependant on Model



**TV** This button puts the Remote in TV control mode

**Sat** This button puts the Remote in a Multi Satellite control mode

\* A number of modes are available. See below for details

**iViewer** This button puts the Remote into an Internet Player mode

\*This is only used on some TVs and Digital Boxes

### To Set the Multi-Satellite Mode button

The Sat button  is programmable in the remote and can be set as follows:





To set the button if you have no Satellite Receiver:  
Press  and at the same time press 0

If you have a Satellite Receiver with Recorder (Known as “Plus” type)  
Press  and at the same time press 1

If you have a Satellite Receiver with High Definition (Known as “HD” type)  
Press  and at the same time press 2

If you have a normal Digital Satellite Receiver (Known as “Digital” type)  
Press  and at the same time press 3

If you want to use this button to switch on the DVD Player  
Press  and at the same time press 4  
DVD Player only fitted on certain models.

- |   |                       |
|---|-----------------------|
|  | + 0 ~ NO SAT RECEIVER |
|  | + 1 ~ SAT +           |
|  | + 2 ~ SAT HD          |
|  | + 3 ~ SAT DIGITAL     |
|  | + 4 ~ DVD             |

---

## Remote control (continued)

### Installing Batteries in the Remote Control

1. Remove the battery compartment cover at the rear of the remote control by pushing the retaining clip forward and pulling up.
2. Install the supplied batteries, ensuring the polarity matches what is shown in the battery compartment.
3. Replace the battery compartment cover.

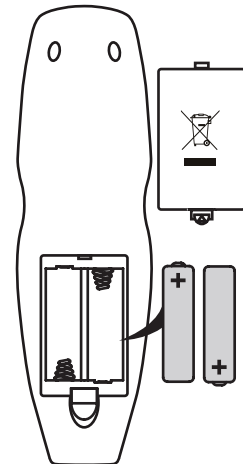

### Using the Remote Control

To use the remote control point it at the TV and press the required buttons. You must be within 6 meters and at an angle of less than 30 degrees from the center of the TV.

NOTE: Sunshine or other strong light sources may interfere with the signal from the remote control. In this situation turn the TV away from the light source.



**WARNING! DO NOT LEAVE BATTERIES IN THE REMOTE CONTROL FOR EXTENDED PERIODS AS THEY CAN LEAK OR CORRODE CAUSING DAMAGE TO THE REMOTE CONTROL. CHECK THEM PERIODICALLY AND REPLACE THEM AS REQUIRED.**

---



**WARNING! DO NOT MIX BATTERY TYPES. WHEN INSERTING BATTERIES, REPLACE ALL BATTERIES AT THE SAME TIME. DO NOT MIX OLD AND NEW BATTERIES.**

---



**WARNING! EXHAUSTED BATTERIES MUST BE TREATED WITH CARE AND DISPOSED OF ACCORDING TO ANY SAFETY OR RECYCLING REGULATIONS IN FORCE IN YOUR LOCAL AREA, NEVER DISPOSE OF BATTERIES INTO GENERAL WASTE, OR FIRE.**

---



**WARNING! NEVER EXPOSE BATTERIES TO EXCESSIVE HEAT SUCH AS SUNSHINE, FIRE OR THE LIKE.**

---

---

## Aerial connection

---

**WARNING! ENSURE THE TV AND ALL ANCILLARY EQUIPMENT IS UNPLUGGED FROM THE MAINS BEFORE MAKING ANY CONNECTIONS!**

---

### Connecting the TV Antenna

Connect the TV antenna to the aerial socket with a 75 ohm co-axial plug. For best results use a high gain TV aerial, preferably roof or loft mounted.

- To improve picture quality in a poor signal area, purchase and install a signal amplifier.
- If the antenna needs to be split for two TVs, use a 2-Way Signal Splitter (not supplied).

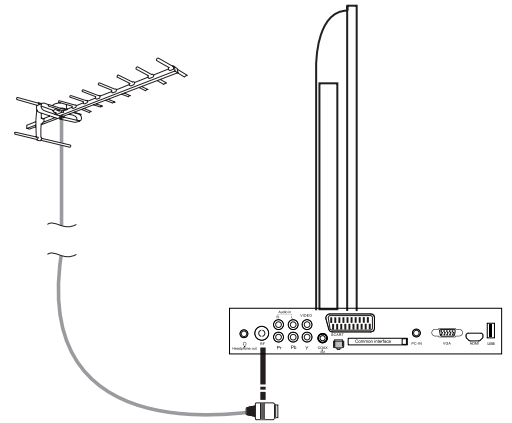

## Connecting external devices

This instruction manual shows the simplest and most effective way of connecting your TV to ancillary equipment. Alternate methods are listed below.

### HDMI Lead

You can connect this TV to a compatible device using a HDMI lead. This method will give the best picture.

Connect the cable from the HDMI equipment to the TV HDMI socket.

### SCART Lead

You can connect this TV to a compatible device using a SCART lead. The connection uses component video signals, i.e. the red, green and blue (RGB) content of the video are sent on separate signals.

### VGA Cable

You can use your TV as a monitor for your personal computer by using a VGA cable. Sound from your personal computer may also be played through the TV.

## Connecting external devices (continued)

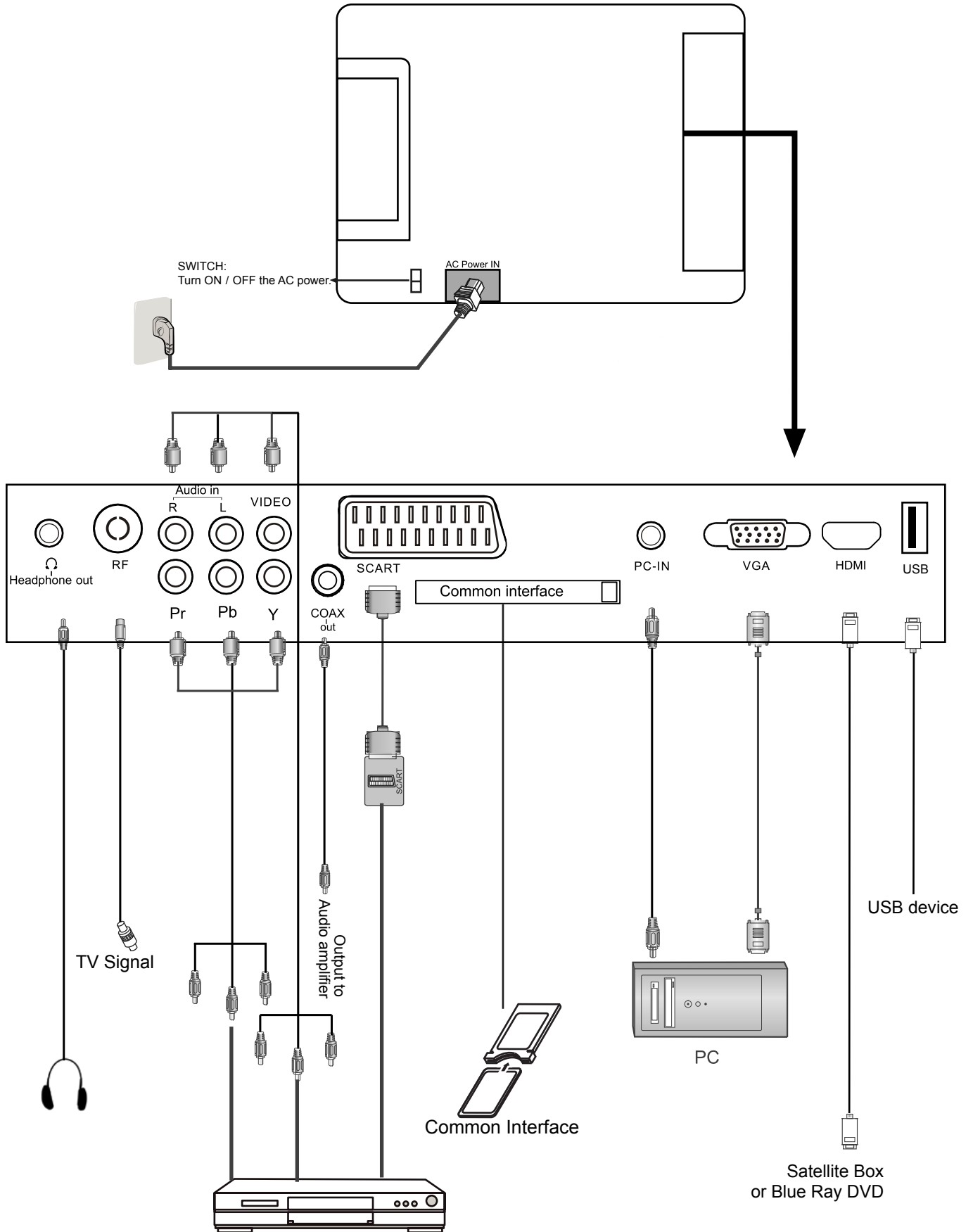

---

## Connecting external devices (continued)

### CONNECTIONS

Name	Function Description
AC POWER IN	Connect to power supply
USB	Connect to USB device for multimedia
HDMI	Connect to the HDMI socket of your DVD or Satellite Box
SCART	Connect to the scart input / output of external devices
PC audio in	PC audio input
VGA	Connect to the PC VGA output to display PC graphics
COAX	Output to audio amplifier
Ω Headphone	Connect Headphone
YPbPr	Connect to the YPbPr output on external devices
Video	Connect to the video output of external devices
RF	Connect to antenna or cable source
CI	CI slot (pay as you view card slot)

### Caution:

Before connecting external devices:

- Make sure to disconnect the appliances from the power supply in order to avoid any potential damage from occurring.
- Make sure to establish the required connection.
- Make sure that the connectors are properly and correctly attached before connecting the appliances to the power supply.

---

## Connecting external devices (continued)

### PC connection

As PCs are sometimes still supplied with a 'conventional' CRT monitor, you may need to adjust the display settings of your PC's graphics card, otherwise the pictures may not appear correctly. Switch on your PC (still with your original monitor connected) now select the screen resolution, and select 60Hz refresh rate. Switch off your PC, then connect it to your TV while both appliances are still switched off.

### VGA, HDMI PC Connection

Use a PC-VGA cable (not supplied) to connect the TV to your PC. You can also use an HDMI cable to connect to your PC (if your PC Graphic card supports HDMI). When the HDMI cable is used, the PC audio cable is no longer required. If you use the HDMI to DVI cable, you will need to use the PC audio cable. Connect all cables carefully and do not bend or break the connector pins.

When using the VGA cable

- Switch on the TV
- Switch on the PC
- Select PC/VGA as input source

When using the HDMI cable

- Select HDMI as input source

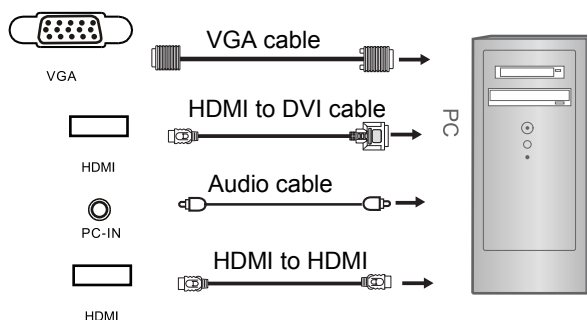

( All illustrated cables are not supplied)



---

## Connecting external devices (continued)

### Connecting Video camera and Video recorder

#### Video camera

- Connect the AV cable to the TV and to the video camera.
- Turn on both video camera and the TV.
- Select AV/CVBS source
- You can now see the playback picture from the video camera.

#### Note:

- To connect the video camera using other cables, refer to the video camera instruction manual.

#### Video recorder

- Connect the Scart cable to the TV and video recorder.
- Turn on both video recorder and the TV.
- Select Scart source
- You can now see the playback picture from the video recorder.

#### Note:

- To connect the video recorder using other cables, refer to the video recorder instruction manual.

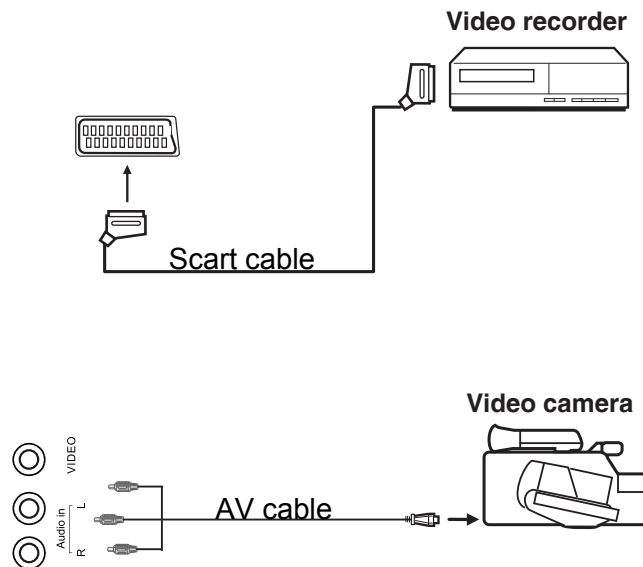

(All illustrated cables are not supplied)

---

## Connecting external devices (continued)

### Connecting an audio system

You can supply the TV sound to the stereo system (A) with the Scart socket. Use a special scart cable SCART to RCA. (Please consult your hi-fi instructions for details). If you have a surround sound amplifier/decoder (B) Use the Scart cable or the special scart cable Scart to RCA.

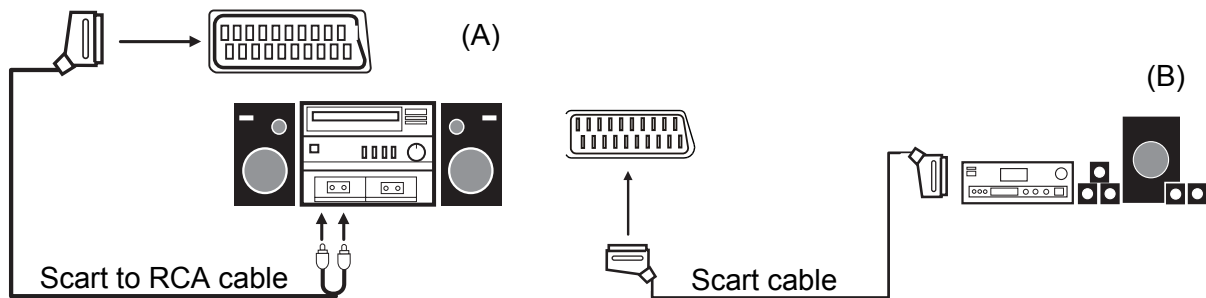

(All illustrated cables are not supplied)

### Connecting a DVD player

Connect a DVD player using either a SCART cable or the HDMI cable.  
(only if your external equipment supports HDMI).

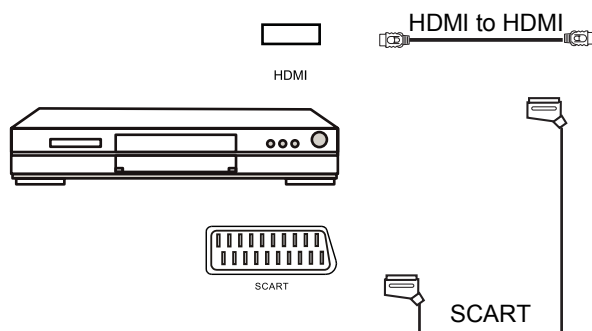

When using the SCART cable

- Switch on the TV
- Switch on the DVD player
- Select SCART as input source

When using the HDMI cable

- Select HDMI as input source

(All illustrated cables are not supplied)

---

# Common Interface Slot

## USING YOUR COMMON INTERFACE SLOT

### Common Interface

The Common Interface (CI) slot is designed to accept the Conditional Access Module (CAM) and Smart Card in order to view the pay TV programmes and additional services. Contact your Pay Per View TV service provider to get more information about the modules and subscriptions.

NOTE: Conditional Access Module and Smart Cards are sold separately.

---

**WARNING! SWITCH OFF YOUR TV BEFORE ANY MODULE IS INSERTED INTO THE COMMON INTERFACE SLOT, THEN ADD THE SMART CARD TO THE CAM.**

---

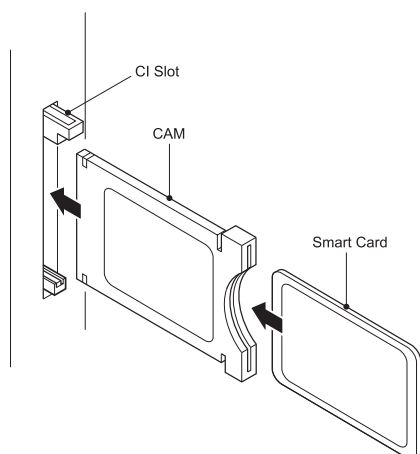

1. Turn on the TV and ensure 'DTV' Source is selected.
2. If the CAM is detected the TV will display the following message on the screen. "Common Interface Module inserted" wait for a few moments until the card is activated.
3. Select the relevant digital Pay Per View channel.
4. Detailed information on the Smart Card in use is displayed
5. Press the Ok button to access the card menu. Refer to the Module Instruction Manual for setting details.
6. When the module is removed, the following message will appear on the screen. "Common Interface module removed".

---

## Auto installation setup



Power On / Off the TV

Press the power button on the LCD TV or the  button on the remote control, the standby indicator will light green.

To turn off the LCD TV

Press the power button on the LCD TV or the  button on the remote control, the standby indicator will light red.

When you initially turn on the TV you will see the first time installation menu as below:

Ensure that the aerial is plugged into the TV, Make sure your Remote is in TV mode (by pressing  button), switch on the TV by pressing . You will see the first time installation menu.

Press the  button on the remote control to start the tuning procedure. This process will find all available ATV and DTV channels and store them.

By pressing the Quick Start button the first time installation can be recalled at any time.

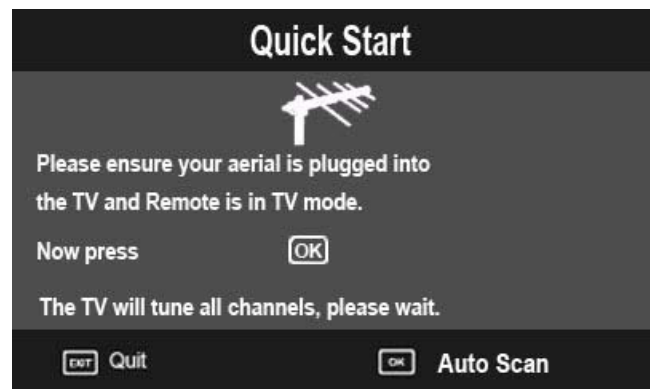

## Source Menu

You can select the input source menu by pressing the Source button on the remote control or the TV / AV button on the TV.

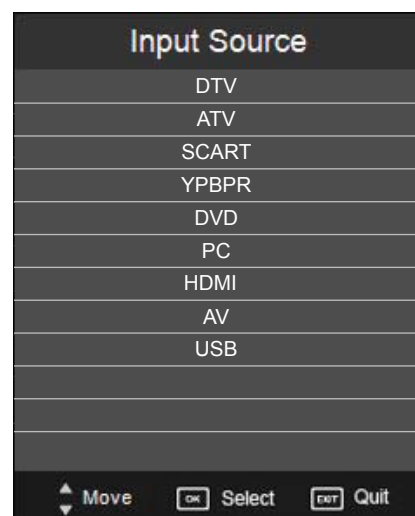
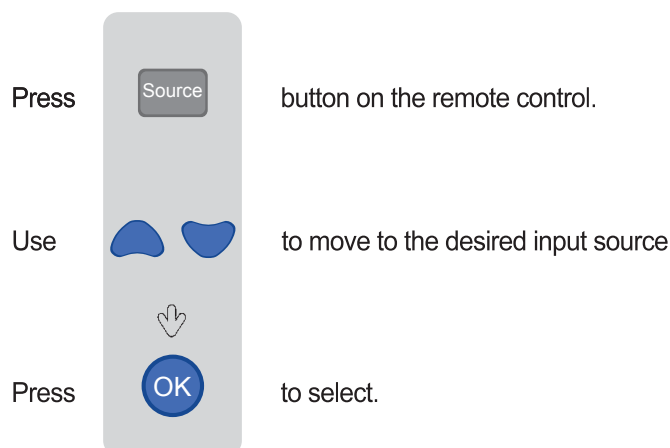

---

# Menu Settings

1. Turn the TV on.
2. Press the MENU button on the Remote Control.
3. Use the ◀ and ▶ buttons to navigate through the menu.
4. Press the EXIT button to exit the Menu.

---

## TV SETTINGS MENU

Allows you to search channels and set up a variety of channel options.  
(Select DTV source for example)



## PICTURE MENU:

Allows you to make adjustments to your picture settings.  
(Select DTV source for example)

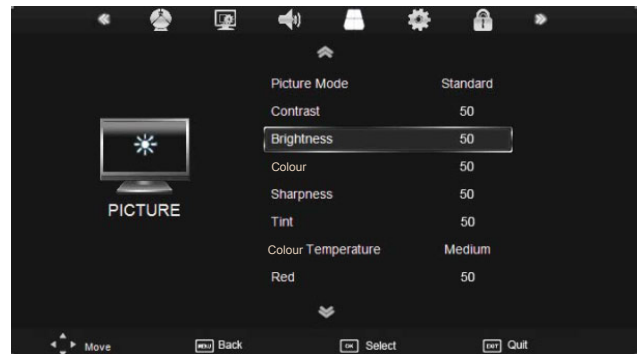

---

## SOUND MENU:

Allows you to customize the sound options and effects.  
(Select DTV source for example)

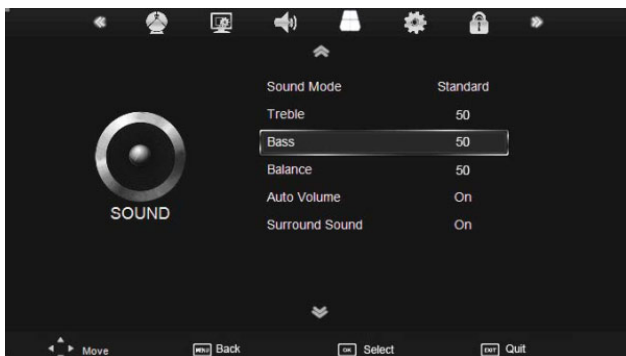

---

## EXTRAS MENU:

Allows you to setup a variety of time options.  
(Select DTV source for example)



---

## OPTIONS MENU:

Allows you to setup a variety of setup options.  
(Select DTV source for example)



---

## LOCK MENU:

Allows you to set up a variety of lock and setup options.  
(Select DTV source for example)

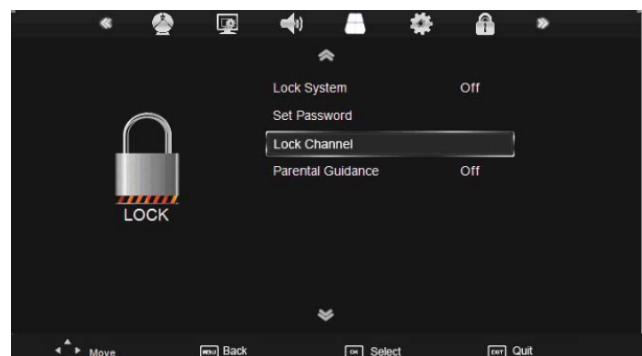

Note: Use the left right up down navigation buttons to select the required options in the menus.

---

## Menu Settings (continued)

### 1. TV SETTINGS menu



#### Description

---

##### Auto Scan

Press the **OK** button to enter the menu, and select the Country and Tuning mode for the TV, then press **OK** button to start the auto tuning.

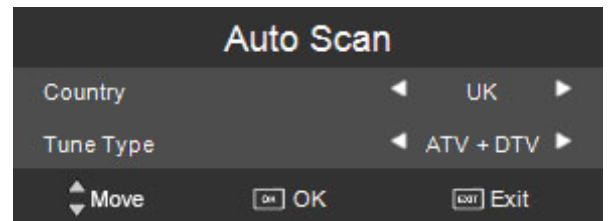

##### DTV Manual Tuning

Press the **OK** button to enter the DTV Manual Tuning menu, select a DTV channel, press the **OK** button to start searching.

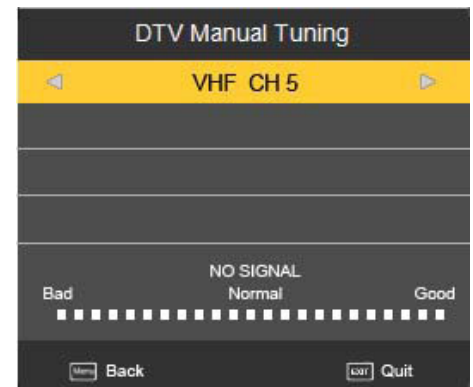

##### ATV Manual Tuning

Press the **OK** button to enter the ATV Manual Tuning menu.

**Storage To:** Select a position for storing the programme.

**System:** Select a TV system for searching.

**Current CH:** Select the channel you want to manually tune.

**Search:** Press ◀ / ▶ buttons to manually search.

**Fine Tune:** Press ◀ / ▶ buttons to fine-tune.

**Frequency:** Displays the current frequency.

*Note: Press the RED button to save your settings*

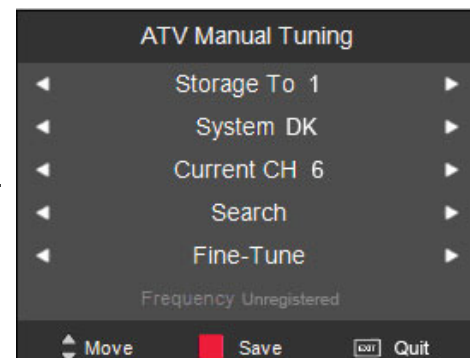

---

## Menu Settings (continued)

### Programme Edit

Press the **OK** button to enter the Programme Edit menu as below.

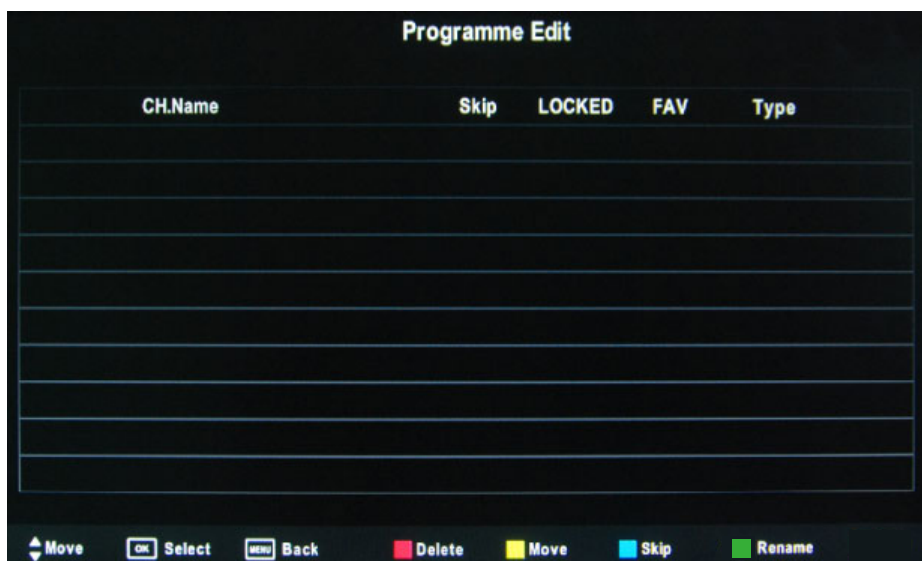

**Delete:** Select a channel and press the **RED** button to delete it.

**Move:** Select an **ATV** channel, and press the **YELLOW** button, then you use ▲ buttons to change the position of the programme, press **YELLOW** again to confirm the change. Press menu to exit and your new changes will be saved.

**Skip:** Select a channel and press the **BLUE** button, this will label the channel. As long as the channel has a skip label it will be skipped when searching through the channels using the CH+/- buttons.

**Rename:** Select an **ATV** channel and press the GREEN button to change the name of the channel by using the ◀▶▲▼ buttons.

### Signal Information

Displays the digital TV-signal information (DTV mode only).

### CI Information

Please contact your “pay per view” provider who can supply a viewing card and cam unit with instructions for their use.

---

## Menu Settings (continued)

### 2. PICTURE menu

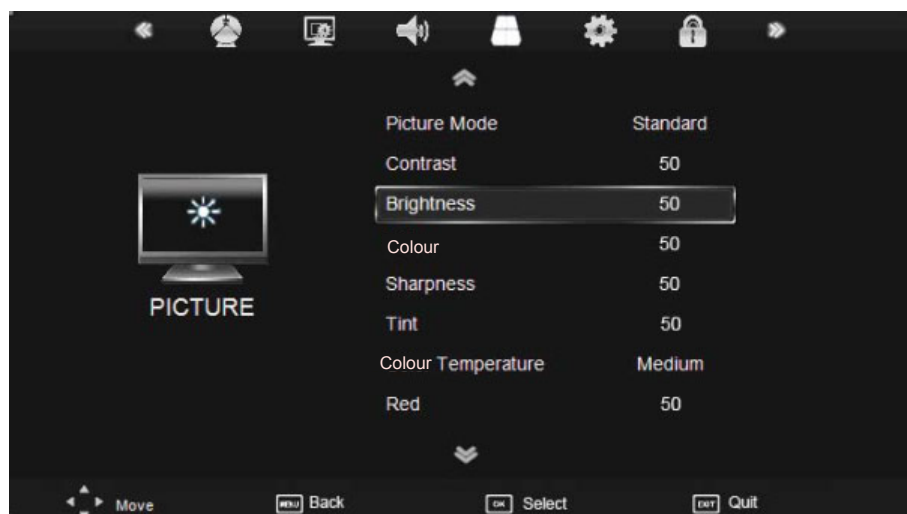

#### *Description*

---

**Picture Mode:** Choose from Standard, Dynamic, User and Mild.

**Note:** *Contrast, Brightness, Colour and sharpness are only available and can be adjusted in the User mode option in the Picture Mode Settings.*

**Contrast:** Controls the difference between the brightest and darkest regions of the picture.

**Brightness:** Controls the overall brightness of the picture.

**Colour:** Control the colour.

**Sharpness:** Increase this setting to see crisp edges in the picture; decrease it for soft edges.

**Tint:** Controls the tint ( NTSC mode only).

**Colour Temperature:** Choose from Medium, Cool, User and Warm.

**Red:** Controls the red colour of the picture.

**Green:** Controls the green colour of the picture.

**Blue:** Controls the blue colour of the picture.

**Aspect Ratio:** Choose from 4:3, 16:9, Zoom1, Zoom2, Just Scan and Panorama.

**Noise Reduction:** Choose interference noise modes from Off, Low, Middle, High and Default.



---

## Menu Settings (continued)

### 3. SOUND menu

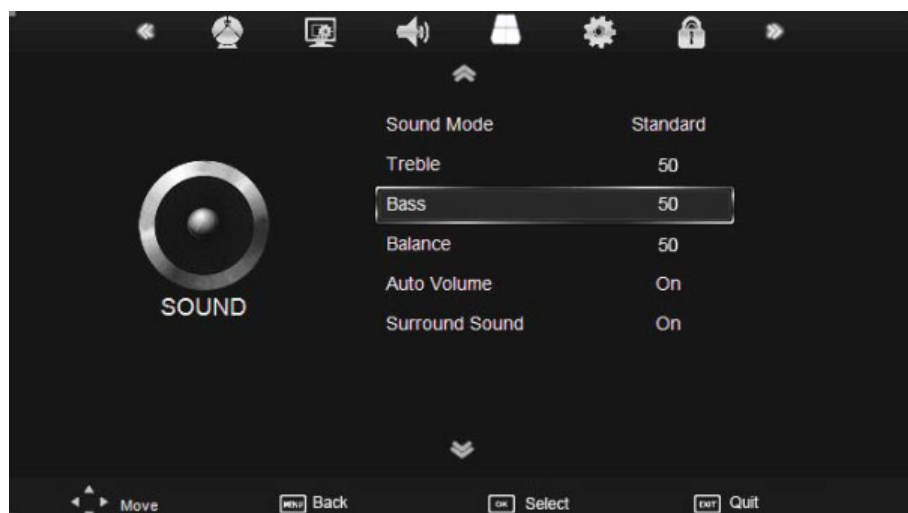

#### *Description*

---

**Sound Mode:** Allows you to select among: Standard, Music, Movie, Sports and User.

**Treble**(Can be adjusted when the sound mode is set to User): Controls the relative intensity of higher pitched sounds.

**Bass** (Can be adjusted when the sound mode is set to User): Controls the relative intensity of lower pitched sounds.

**Balance:** To adjust the balance of the left and right speakers audio output, or turn off the volume of the left or right speaker.

**Auto Volume:** This feature automatically adjusts the audio level when the TV is turned on. This function is activated by selecting “On”.

**Surround Sound:** Turn on / off the surround sound function by selecting “off” or “surround”.

---

## Menu Settings (continued)

### 4. EXTRAS menu



#### *Description*

---

**Sleep Timer:** Allows you to setup the sleep timer: 10min, 20min, 30min, 60min, 90min, 120min, 180min, 240min and off.

**PC Setup (PC mode only) :** Press the **OK** button to enter the submenu to adjust the Horizontal / Vertical position or Size and Phase of the picture.

*Note: The options Schedule List, Recorded List, Timer Record and PVR File System are described on pages 31 -33.*

---

## Menu Settings (continued)

### 5. OPTIONS menu



#### *Description*

---

**OSD Language:** Allows you to select the on screen display menu language.

**Audio Language** (can only be selected in DTV mode): Select the audio language.

**Subtitle Language** (can only be selected in DTV mode): Select the subtitle language.

**Menu Time Out:** Allows you to setup the length of time that the on screen display is visible: 5s, 10s, 15s, 20s, 25s, 30s, 35s, 40s.

**Country:** This is defaulted to UK, but can be changed by using the Auto tune function.

**DVD Setup:** Press the **OK** button to enter the DVD Setup menu (in DVD mode only).

**Restore Setting:** Press the **OK** button to restore the factory default settings.

---

## Menu Settings (continued)

### 6. LOCK menu

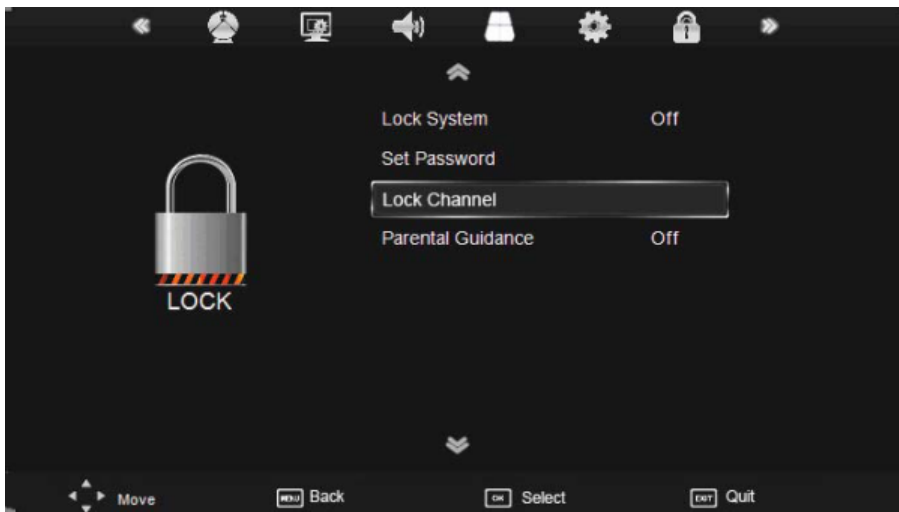

#### Description

---

**Lock System:** Turn on/off the Lock System function.

**Note:** Enter your password to operate this menu.(the default password is 0000)

**Set Password:** If the Password has been changed you must enter the current password.

New: Enter the new password.

Confirm: Enter the new password.

**Lock Channel:** You must enter the password to view channels that have been locked. Use ▲ and ▼ buttons to select the channel and press the GREEN button on the remote control to lock the channel.



**Parental Guidance:** Control your childs viewing using the Parental Guidance mode.

# Multimedia Operation

## Basic Operation

1). Press the SOURCE button on the remote control to display the input source menu, select the USB source with the **▼▲** buttons and press the OK button to enter the Multimedia menu below.

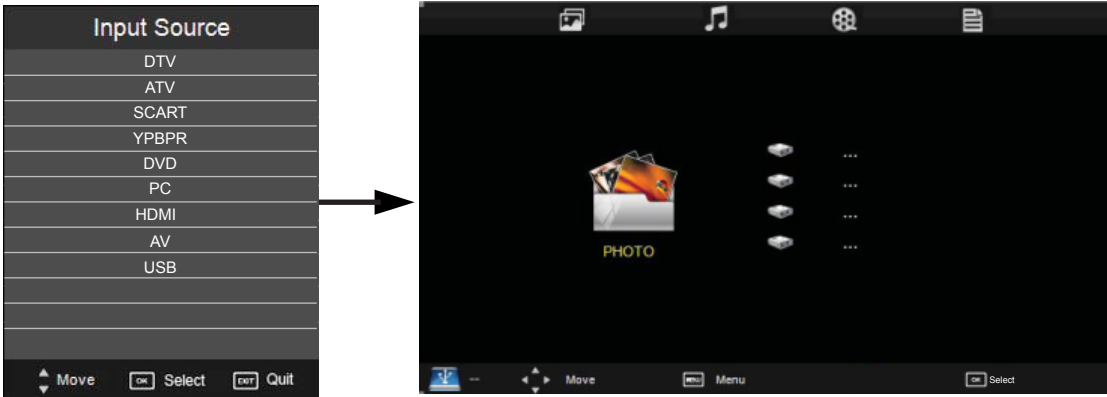

2). Insert the USB device, the name of the device will be displayed on the screen.

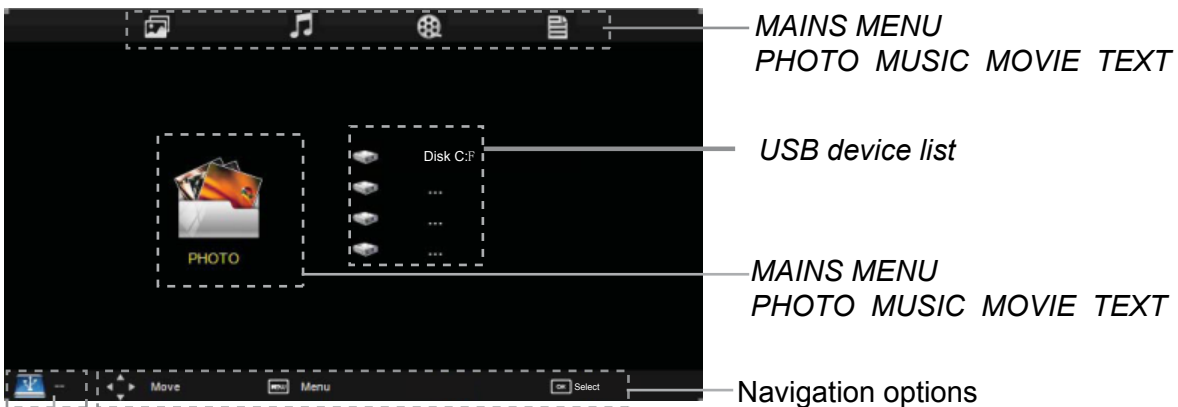

Information of the USB device

3). Press **◀ / ▶** button to select the files on the USB device (PHOTO, MUSIC, MOVIE, TEXT) to view or play.

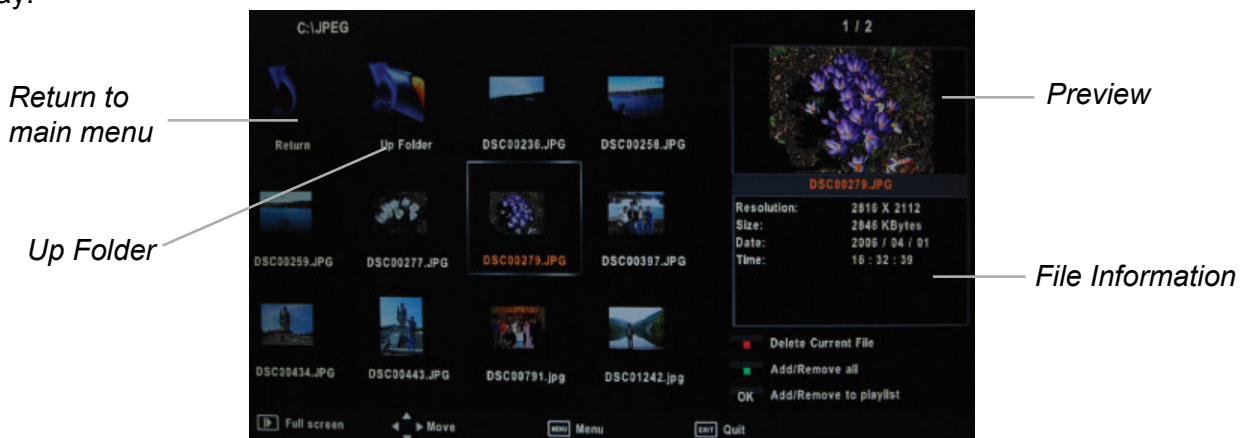

Press **◀ / ▶ / ▲ / ▼** buttons to select and the OK button to activate the file or open folder. Press **▶** button to play the files in full screen mode. When in full screen mode press the **OK** button to show the navigation option menu on the bottom of the screen or press **■** stop button to return to files.

---

## Multimedia Operation (continued)

### 1. Photo

Photo viewing



Press ◀/▶ buttons to select the option on the menu, and press the **OK** button to activate.

**Repeat:** Select the repeat mode from Repeat All, Repeat 1, Repeat None.

**Music:** Play/Pause the background music of your choice.

**Playlist:** Display the playlist on the screen and select the photo of your choice.

**Info:** Display the information of the file.

**Rotate:** Rotate the photo clockwise/counterclockwise.

**Zoom In/Out:** Zoom In/Out of your photos.

**Move View:** Move the photo in Zoom out mode.

---

### 2. Music

Listen to music



Press ◀/▶ buttons to select the option on the menu, and press the **OK** button to activate.

Press ▼/▲ buttons to select the music, and press the **OK** button to play.

**Repeat:** Select the repeat mode from Repeat All, Repeat 1, Repeat None.

**Search:** Program the music to play from the time you set.

Press the **OK** button to display the time table, and select the position with the ◀ ▶ ▼ ▲ buttons, set the time using the numeral buttons on the remote, select "OK" and press the **OK** button to search.

**Screen Saver:** Press the **BLUE** button to enter the Screen Saver mode, press again to exit.

---

## Multimedia Operation (continued)

### 3. Movie

Watch a film



Press ◀/▶ buttons to select the option on the menu, and press **OK** button to activate.

**Repeat:** Select the repeat mode from Repeat All, Repeat 1, Repeat None.

**Set A-B:** Select and play the preferable part of the file by setting A and B at the beginning and end. Press **OK** button to cancel.

**Playlist:** Display the playlist on the screen.

**Info:** Display the information of the movie file.

**Slow:** Play the movies at slow speed, press |▶ button to cancel and resume at normal speed.

**Step:** Step quickly through the movie by using this option

**Search:** Program the movie form the time you set.

**Zoom In/Out:** Zoom In/Out of the movie screen.

**Aspect Ratio:** Select the aspect ratio of the on screen display.

**Move View:** View the film in Zoom out mode.

---

### 4. Text

View text files



Press ◀/▶ buttons to select the option on the menu, and press the **OK** button to activate.

**Prev/Next page:** Turn to previous/next page of the text.

**Prev./Next:** Turn to previous/next file.

**Stop:** Stop auto turning pages.

**Music:** Play/pause the background music of your choice.

**Playlist:** Display the playlist on the screen.

**Info:** Display the information of the text file.

---

# Recording Operation

## PVR settings

Press the MENU button, and select EXTRAS menu.



### 1). Schedule List

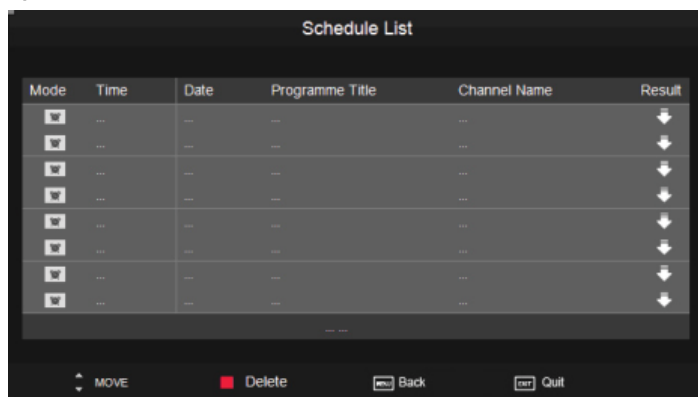

Display the recorder schedule list.

### 2). Recorded List



**INFO:** Display the information of the programmes you have recorded.  
**RED button:** Delete the recording you select.



---

## Recording Operation (continued)

### 3). Timer Record

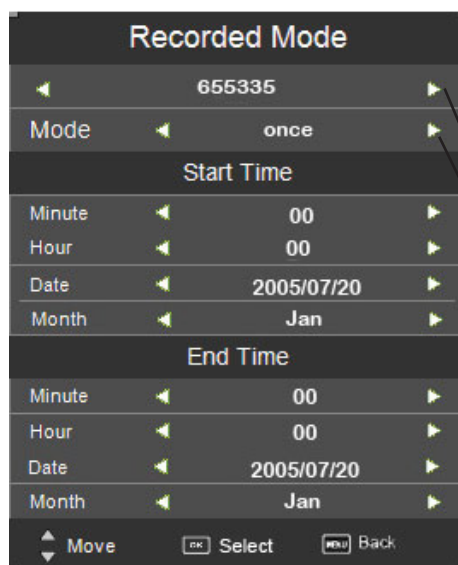

#### Set the timer record

The TV will record the programme automatically according to your settings.

**TITLE:** Select the channel you want to record.

**MODE:** Select the record mode.

**Start Time:** Select the start recording time.

**End Time:** Select the end recording time.

Press the **OK** button to save the setting and exit the menu.

### 4). PVR File System

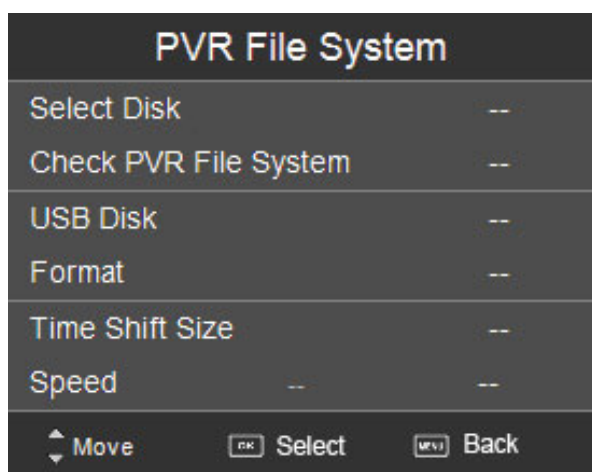

Setup the PVR File system before you start recording.

**Select Disk:** Select the device for the Recorded files.

#### Check PVR File System

**USB Disc:** Displays the USB state.

**Format:** Format the USB device

**Time Shift Size:** Displays the size of the USB device.

**Speed:** Displays the speed of the USB device.

---

## Recording Operation (continued)

### 5) Start Recording

#### Record and Time shift function buttons

**R Recording:** Press to start recording.

**PAUSE:** Press to enter the timeshift mode, press again to play the recording.

**Stop:** Press to stop recording or timeshift.

**B:** Displays the list of programmes scheduled for recording.

**A:** Displays the list of programmes already recorded on the USB device.

#### 1) Recording menu

When you press **R** REC button, the screen will display the recording menu as below:



- Note:
- display and exit full mode by pressing the **R** REC or Exit buttons.
  - Press the STOP button to stop the recording and exit the recording mode.
  - Press the PLAY button to play the programme you are recording from the beginning.

#### 2) Timeshift menu

Press **PAUSE** button to enter the Timeshift mode, and the picture will be paused, the recording will begin.

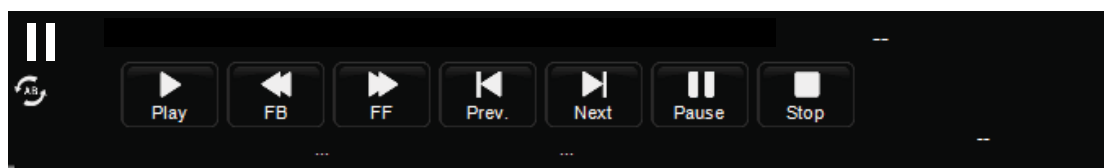

- Note:
- Display and exit the navigation menu by pressing the Exit button.
  - Press the STOP button to exit the Timeshift mode.
  - Press **PLAY** button to play the programme you are recording from the beginning.

---

## EPG menu

Display the programme guide by pressing the **GUIDE** button.

Press the **BLUE** button to highlight the top of the table in yellow, press the ◀ / ▶ to select CHANNEL or TIME.

Programme list by TIME

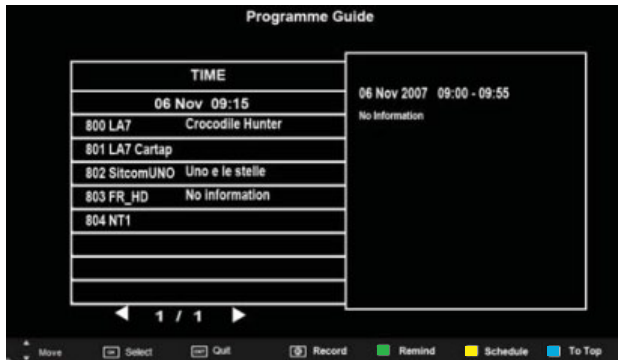

Press ▼ / ▲ button to highlight the date, now press the ◀ / ▶ buttons to select the date you want to view (7 day EPG)

Programme list by CHANNEL



Press the ▼ / ▲ buttons to highlight the channel option, press ◀ / ▶ buttons to select the channel you want to view.

You can select a programme for recording using the ▼ / ▲ buttons.

**Record:** Press **R** button to display the Recorded Mode menu, and set the timer record. When the programme starts it will be recorded to the USB device.

**Remind:** Press the GREEN button to display the remind menu, and set the time. When the programme starts the TV will automatically switch to this programme.

**Schedule:** Press the YELLOW button to display the schedule list.

**To Top:** Press the **BLUE** button to return to and highlight the top of the table.

---

## DVD Operation

Turn on your TV then use the Source button on the remote control or the TV/AV button on the TV to select DVD mode. If there is no disc in the DVD player the screen will show "NO DISC".

### Place a disc

Insert a disc according to the instruction label next to the dvd insert slot.

Avoid touching the playing surface.

Hold the disc around the outside with your fingers and place the disc into the slot. The player will automatically draw the disc into the player.

To "Eject" the disc, press the "eject" button on the TV or on the remote control.

### Play

The contents of each disc vary, as to how the disc was authored and what features are included. Some discs start playing as soon as they have been read, some need "Play" selecting in the Menu. Different play modes are offered, such as Menu Play, Sequence Play and other modes.

### Using the INFO Feature

1. Compatible with DVD, SVCD, VCD, CD, HD-CD, WMA, Digital Audio disc discs.

2. Loading and playing DVDs (two pages)

- Press INFO button once to show the first page:

- "Disc Type, Title \* / \* (the playing title / total titles), Chapter \* / \* (the playing chapter / total chapters), Elapsed Time of the Disc".

- Press the button again to show the second page:

- "Language \*/\* (the serial number of playing language / the amount of optional languages) or Off, Language Type, Audio Type, Subtitle \* / \* (the serial number of playing subtitle /the amount of optional subtitles) or Off, Angle \* / \* (the serial number of playing angle / the amount of optional angle) or Off".

- Press the button for the third time, the INFO menu fades out.

3. Loading and playing SVCD discs (two pages)

- Press INFO button once to show the first page:

- "Disc Type, Track \* / \* (the playing track / total tracks), Mute, PBC, Repeat Mode, Elapsed Time of the Playing Track".

- Press the button again to show the second page:

- "Language \* / \* (the serial number of playing language/ the amount of optional languages) or Off, Language Type, Audio Type, Subtitle \* / \* (the serial number of playing subtitle / the amount of optional subtitles) or Off".

- Press the button for the third time, the INFO menu fades out.

4. Loading and playing VCD

- Press INFO button once to show the first page:

- "Disc Type, Track \* / \* (the playing track / total tracks), Mute, PBC, Repeat Mode, Elapsed Time of the Playing Track".

- Press the button again, the INFO menu fades out.

5. Loading and playing CD, HD-CD, WMA, Digital Audio / JPEG discs

- Press INFO button once to show the first page:

- "Disc Type, Track \* / \* (the playing track / total tracks), Mute, Repeat Mode, Elapsed Time of the Playing Track".

- Press the button again, the INFO menu fades out.

### Subtitles

1. Compatible with DVD, SVCD discs.

2. Press the Subtitle button on the remote once, and the subtitle info banner appears

3. When a DVD or SVCD is recorded with subtitles, you can use the Subtitle feature to view the subtitles on-screen. By default, subtitles are off. The info banner will display Subtitle Off.

4. To display subtitles, press the Subtitle button again. The default language with its responding serial number will be displayed in the info banner and subtitles will be displayed in that language. There are 8 supported subtitles: Chinese, English, Japanese, French, Spanish, Portuguese, Germany and Latin. With each consecutive press of the Subtitle button, the subtitle switches.

For example, "Language Icon: [1 English DTS 6CH] or [Off]" (the availability of the subtitles are disc-dependent). To turn subtitles off, press the Subtitle button until Subtitle Off is displayed.

---

## Digital Audio Disc

1. Compatible with Digital Audio discs
2. The player will search the disc directory automatically and display the contents on screen.
3. The player will then start to play the first track, of the selected directory.
4. To change directories use the direction buttons.

## DVD System Operation

System operation will define the setting of the set; these definitions will be stored until you change them again.

### General Steps of Setup Menu

1. Pause or Stop the player. Press **MENU** button on the remote control and select **OPTIONS** menu as below, then select **DVD SETUP**, press the **OK** button to enter the DVD main menu as below.

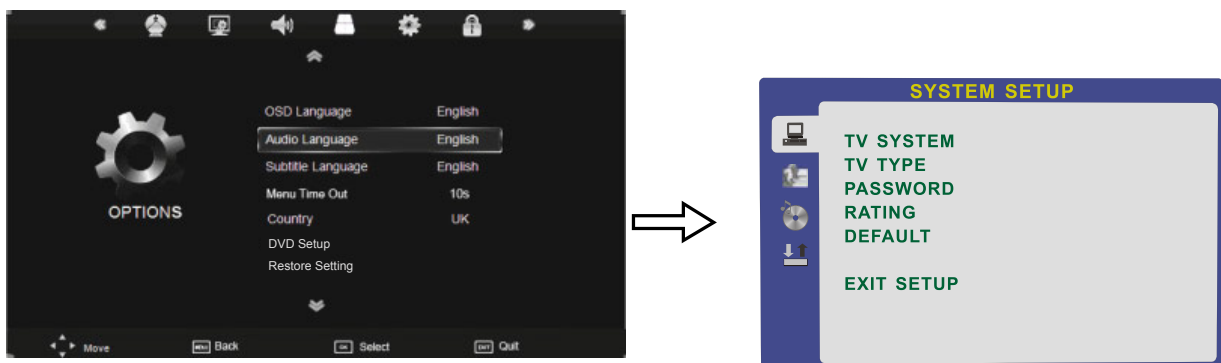

2. Press the  $\uparrow/\downarrow$  buttons to select the Icon of the desired section, e.g. "TV System" and press  $\Rightarrow$  button to open that section.
  3. Press  $\uparrow/\downarrow$  to select the desired feature and again press  $\Rightarrow$  button to open that section.
  4. Press  $\uparrow/\downarrow$  to select the desired feature and then press "**OK**" to select the new setting.
  - 5 To exit the menu, press  $\uparrow/\downarrow$  to select **EXIT SETUP** and then press "**OK**"
- When launching the setup routine, the pressing of the following buttons will turn off the setup menu, while the choices that have been changed will be saved.

### Menu specification

#### 1. SYSTEM SETUP

The system setup options are illustrated below:

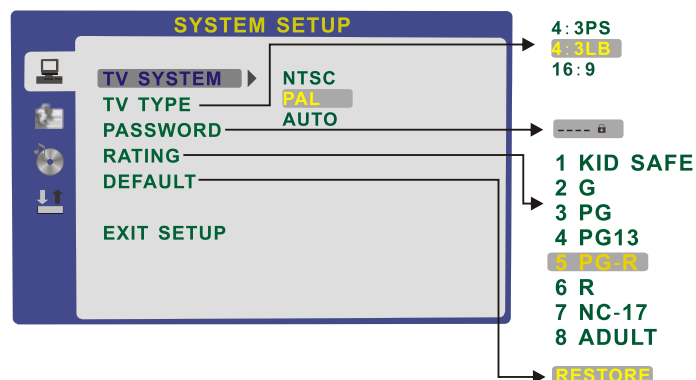

---

## TV SYSTEM

According to the Colour system of your TV, select proper TV TYPE.

## PASSWORD

The password option is initialized as locked. You cannot set the ratings limit or change the password.

To enable these features you must unlock the Password. The default password is "0000". Using the  $\uparrow/\downarrow$  button, move the highlight to "PASSWORD", press the  $\Rightarrow$  button and enter "0000". You will see the padlock symbol open. You may now change the RATING or put in a new password number.

If the Lock symbol is BLUE you must press the  $\Rightarrow$  button to enter the lock field, the lock symbol will change to YELLOW, you may now enter a new 4 digit number. Please remember or write down the new Password and keep safe.

## RATING

The Rating feature is a rating limit feature, like movie ratings. This helps you to control what DVD the family watches. There are 8 levels of selection, from KIDS SAFE to ADULT. Adult is the "play all" selection.

## 2. LANGUAGE SETUP

The language setup options are illustrated below:

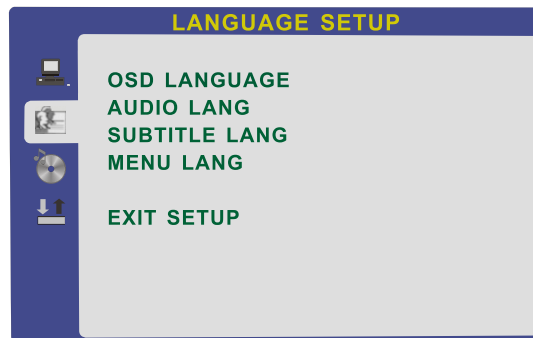

- OSD LANGUAGE: The OSD will display in the language you choose.
- AUDIO LANG: If the disc you are playing has the language you choose, it will output audio in that language.
- SUBTITLE LANG: If the disc you are playing has the language you require you may select this either in the Menu or using the "SUBTITLE" button on the Remote control. You may also switch this OFF.
- MENU LANG: If the disc you are playing has the language you require you may select this.

## 3. AUDIO SETUP

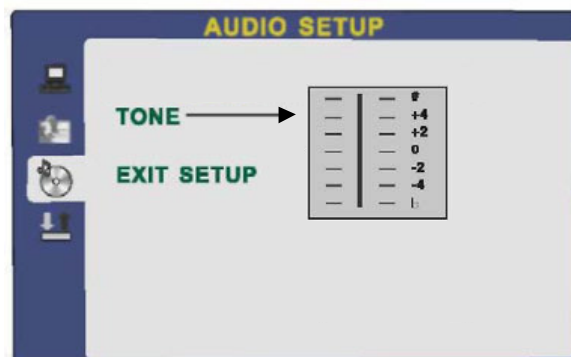

- TONE: Use the  $\uparrow/\downarrow$  button to move the scroll and adjust the tone.

---

## 4. DIGITAL SETUP

The video setup options are illustrated below:

- DYNAMIC RANGE: Use the ↑ / ↓ button to move the scroll and adjust the dynamic range.
- DUAL MONO: Choose the mode of the audio output.
- There are four modes: STEREO, MONO L, MONO R, MIX MONO.

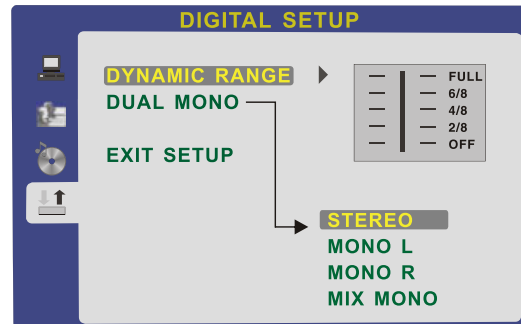

## Disc Care

### About Disc Terms

#### Title

Generally, pictures or music compressed on a DVD are divided into several sections, "title".

#### Chapter

The smaller section unit of picture or music in a DVD under the title, usually one title is comprised of one or more chapters and each of them is numbered for easy searching, but some discs may not have a recording chapter.

#### Track

A segment of picture or music on a CD, Each track is numbered for searching.

### Care of Disc

Video disc contains high-density compressed data that needs proper handling.

1. Hold the disc with fingers by outer edge and/or the center spindle hole. Do not touch the discs surface.
2. Do not bend or press the disc.

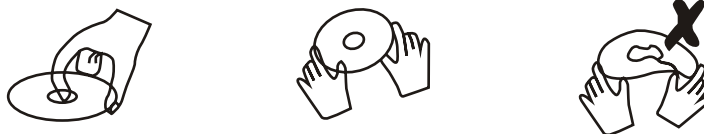

3. Do not expose the disc to direct sunlight or heating sources, Store discs in cabinet vertically, and in dry condition.

Prevent exposure to:

Direct sunlight

Heat or exhaust from a heating device

Extreme humidity

Clean the disc surface with a soft, dry cleaning cloth, Wipe the disc surface gently and radially from center toward the outer edge.

Do not apply thinner, alcohol, chemical solvent, or sprays when cleaning. Such cleaning fluids will permanently damage the disc surface.

## Simple Troubleshooting

If the TV display or performance fails check the TV in accordance with the following instructions. If the TV still fails to function correctly contact your dealer for assistance.

SYMPTOM	POSSIBLE CAUSE	REMEDY
---------	----------------	--------

### GENERAL

Dead. No LED Lit	No power to the TV.	Check all connections to the TV.
Dead. Ledlitred	Set still in standby.	Press either the Power button or on the Remote control.
Blue screen	No signal.	
	Incorrect source selected.	Press Source button to select correct source.
Noisy, snowy, ghosting picture (TV)	Poor aerial signal.	If using an indoor aerial, try moving the aerial. Check aerial connections.
No sound	Sound "Mute".	Turn sound "Mute" OFF.
	Volume set too low.	Check volume settings.
	External leads not connected "if used".	Check all external leads are connected.
Remote control does not work	Remote are not in the correct status	Ensure remote is in TV mode by pressing TV button.

### DVD

Will not accept disc	DVD not selected	Select DVD mode with Source button.
Screen shows "NO DISC"	Disc placed incorrectly	Disc must have mirror side facing you if single sided.
	Disc damaged or dirty	Inspect disc. If damaged you must discard. If dirty see "Disc care" page 38.
Picture "Freezes" or breaks up	Disc damaged or dirty.	See "Disc care" page 38.
Certain disc functions not working.	Disc may not support required feature.	Read disc information.

If none of the suggestions seem to work, try switching your TV off and then on again. If this does not work contact our technical helpline 0871 288 7345.

NOTE: The TV must only be repaired by a qualified registered service person. Never attempt to remove the back cover as the TV has dangerous voltages inside that may cause fatality or fire.



---

## TECHNICAL SPECIFICATIONS

Specifications of the TV that you have just purchased may vary from the information in this table due to technical innovations.

### TV Specifications

TV System	PAL/BG/DK/ I/SECAM/BG/DK/L/L'
Audio System	BG/DK/I/L/L'
Screen size	22"(Diagonal)
Resolution	1366 x 768 Pixels(RGB)
Aerial input	75 $\Omega$ (unbalanced)
Audio output power	2 x 3W
Power requirements	100-240V ~ 50/60Hz
Power consumption	< 60W
Standby power consumption	<1W
Weight	5.2 kg

### Remote control specifications

Type	Infrared
Control distance	6m
Control angle	30 degrees(Horizontal)
Batteries	2 x 1.5V, SizeAA
Dimensions	60 x 204 x 32mm
Weight	140g(without batteries)

---

## Wall Mounting

1. The stand must first be removed. Place the TV face down.
2. Remove the two screws on the back of the TV to release the remaining part of the stand.
3. Remove and store the stand and screws.
4. Use four machine screws to mount the TV on the bracket.

This unit is VESA-Compliant and designed to be wall mounted with a VESA-Compliant 75 mm x 75 mm mounting kit. Mount this unit according to the instructions of the wall bracket (not supplied)

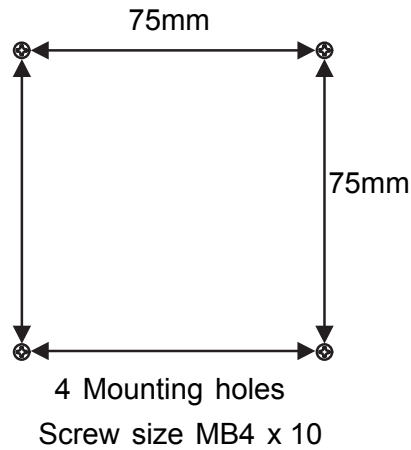

# Waste Electrical Recycling

## Correct disposal of Product



This sign indicates that this product may not be disposed of with your regular household waste. The recycling and separate collection of such products is your responsibility. Please drop off the above mentioned waste at a designated place for recycling waste electrical and electronic equipment. If you do not know where to drop off your waste equipment for recycling, please contact your local city office or household waste collection service.



**Hg Cd Pb**

The crossed out wheeled dust bin symbol indicates that batteries and /or accumulators must be collected and disposed of separately from household waste.

If the battery or accumulator contains more than the specified values of lead (Pb), mercury (Hg), and/or cadmium (Cd) defined in the Battery Directive (2006/66/EC), then the chemicals symbols for lead(Pb), mercury (Hg) and/or cadmium (Cd) will appear below the crossed out wheeled dust bin symbol.



**Pb**

By participating in separate collection of batteries, you will help to assure the proper disposal of products and batteries thus help to prevent potential negative consequences for the environment and human health.

For more detailed information about the collection and recycling programmes available in your country, please contact your local city office or the shop where you purchased this product.



This appliance complies with European Safety and Electrical directives.