

LCD digital colour TV

C19101F

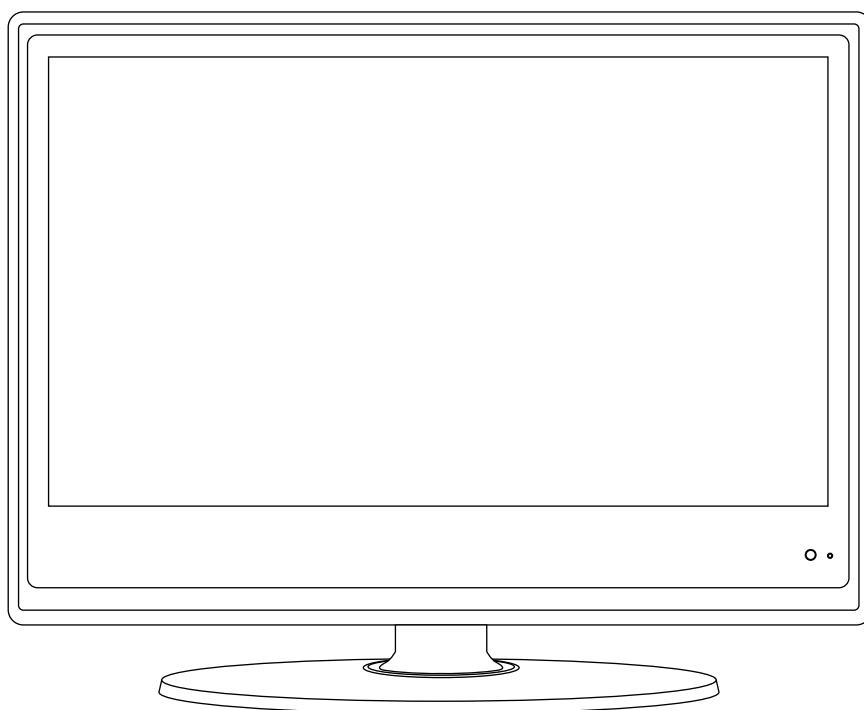

USER GUIDE

Introduction

Thank you for purchasing this LCD TV which has been designed and manufactured to give you many years of trouble free service.

You may already be familiar with using a similar product but please take time to read these instructions which have been written to ensure you get the very best from your purchase.

HDMI

HDMI (High Definition Multimedia Interface) is the next generation of digital interface. Unlike conventional connections, it transmits uncompressed digital and audio signals using a single cable. This TV supports high-definition video input via the HDMI socket on the back of the TV.

Safety is important

To ensure your safety and the safety of others, please read the safety precautions BEFORE you operate this product.

Contents

You will find the following

- TV
- User Guide
- Quick Start Guide
- Remote Control
- 2 x AA Batteries

NOTE: If any of the items listed are damaged or missing please contact our technical helpline on 0871 288 7345

Contents

1-3 SAFETY INFORMATION

4-5 Unit and Accessories

6-9 Remote Control

10 Aerial connection

10-15 Connecting external devices

16 Common Interface slot

17 Auto installation setup

17 Source menu

18-25 Menu settings

26-31 Multimedia Operation

31-32 Recording Operation

33 EPG menu

34-37 DVD Operation

38 TROUBLE SHOOTING GUIDE

39 TECHNICAL SPECIFICATIONS

40 Wall mounting

SAFETY INFORMATION

IMPORTANT SAFETY INSTRUCTIONS - READ CAREFULLY BEFORE USE.

Take note of the following safety information which appears on the back of the TV.



CAUTION TO PREVENT ELECTRICAL SHOCK, DO NOT REMOVE ANY COVER SCREWS, NO USER SERVICEABLE PARTS INSIDE, REFER SERVICING TO QUALIFIED SERVICE PERSONNEL.



This symbol indicates that there are important operating maintenance instructions in the literature accompanying this unit.



This symbol indicates that dangerous voltage constituting a risk of electric shock is present within this unit.

Keep these instructions

- Do not use this TV near water.
 - Clean only with a slightly damp cloth.
 - Do not block any ventilation openings.
 - Install in accordance with the supplied Quick Start Guide and this User Guide.
 - Protect the power chord from being walked on or pinched, particularly at plugs, and the point where it exits from the TV.
 - Do not allow the power chord to overhang the edge of a table.
 - Unplug this TV during lightening storms or when unused for long periods of time.
-



WARNING! TO REDUCE THE RISK OF FIRE OR ELECTRICAL SHOCK, DO NOT EXPOSE THIS TV TO RAIN OR MOISTURE. THE TV MUST NOT BE EXPOSED TO DRIPPING AND SPLASHING AND NO OBJECTS FILLED WITH LIQUIDS SHOULD BE PLACED ON THE TV.

NOTE: No naked flames such as candles should be placed on the TV.

IMPORTANT SAFETY INFORMATION (Continued)

This unit has been produced according to all current safety regulations. The following safety tips should safeguard users against careless use and the dangers connected with such use.

- Although this appliance has been carefully manufactured and rigorously checked prior leaving the factory, as with all electrical appliances it is possible for problems to develop. If you notice smoke, an excessive build up of heat or any other unexpected phenomena, you should disconnect the plug from the mains power socket immediately.
- Ensure that the unit is sufficiently ventilated! Never place next to or underneath curtains!
- The mains plug or appliance coupler is used as the disconnect device, the disconnect device shall remain readily operable.
- This set should only be connected to a mains power supply which matches that stated on the label on the rear of the TV – do not attempt to connect it to any other type of supply.
- The socket – outlet must be installed near the equipment and easily accessible.
- To prevent overload, don't share the same mains supply socket with too many other items of equipment.
- Apparatus with Class 1 construction shall be connected to a mains socket outlet with a protective earthing connection.
- Keep away from rodents. Rodents enjoy biting into electric flexes.
- Always hold the plug when pulling out the plug from the mains supply socket. Do not pull on the flex, the flex can become overloaded and cause a short circuit.
- Set up the unit so that no one is able to trip over the flex.
- Do not place heavy items on the flex, which may damage it.
- Take note that the flex cannot be reached and pulled by young children, avoiding injury.
- Do not set up the unit near to heat sources. The casing and the flex could be damaged by the impact of heat.
- The screen is made of plastic and can break if damage is done to it. Be careful when collecting sharp edged plastic splinters to avoid injury.
- Avoid placing the unit on any surfaces that may be subject to vibrations or shocks.
- To protect the unit during a thunderstorm unplug the AC power cable and disconnect the aerial. Caution: Do not touch the aerial (RF) connector.
- When you leave your home for long periods of time, unplug the AC power cable for safety reasons.
- The unit becomes warm when in operation. Do not place any covers or blankets on the unit in order to prevent overheating. The ventilation holes are not to be blocked. Do not set up near radiators. Do not place in direct sunshine. When placing on a shelf leave 5 cm (2") free space around the whole unit.
- Do not allow water or moisture to enter the TV. Do NOT use in wet or moist areas such as Bathrooms, steamy kitchens or near swimming pools.
- Do not use this unit when moisture condensation may occur
- Any repairs must be carried out by qualified personnel only.
- Do not open this unit. A non – expert attempting to repair the unit could be dangerous and potentially cause a fire hazard.

IMPORTANT SAFETY INFORMATION (continued)

- Liquids spilt into the unit can cause serious damage. Switch the set OFF and disconnect the mains power supply, then consult a qualified service person before attempting to use the unit again.
- Do NOT remove the safety covers. There are no useable or serviceable parts inside. You may invalidate the warranty. Qualified personnel must only service this apparatus.
- Do NOT tap or shake the screen, you may damage the internal circuits. Take good care of the remote control, do not drop.
- Never place hot objects or open flame sources on or close to the TV.
- High temperatures can melt plastic and lead to fires.
- To clean the TV use a soft dry cloth. Do NOT use solvents or petrol based fluids. For stubborn stains, you may use a damp cloth with dilute detergent.

Headphone Warning

Loud music can damage your hearing irreversibly, therefore do not set the volume to a high level when listening through headphones, particularly for lengthy listening periods.

Where to install

Locate the television away from direct sunlight and strong lights, soft indirect lighting is recommended for comfortable viewing. Use curtains or blinds to prevent direct sunlight falling on the screen. Place the TV on a sturdy platform of which the surface should be flat and steady. This will prevent it from falling over.

Make sure the television is located in a position where it cannot be pushed or hit by objects, as pressure will break or damage the screen, and so that small objects cannot be inserted into the ventilation slots or openings in the cabinet.

LCD Screen

The LCD display panels are manufactured using an extremely high level of precision technology, however sometimes some parts of the screen may be missing picture elements or have luminous spots. This is not a sign of malfunction.

Unit and Accessories

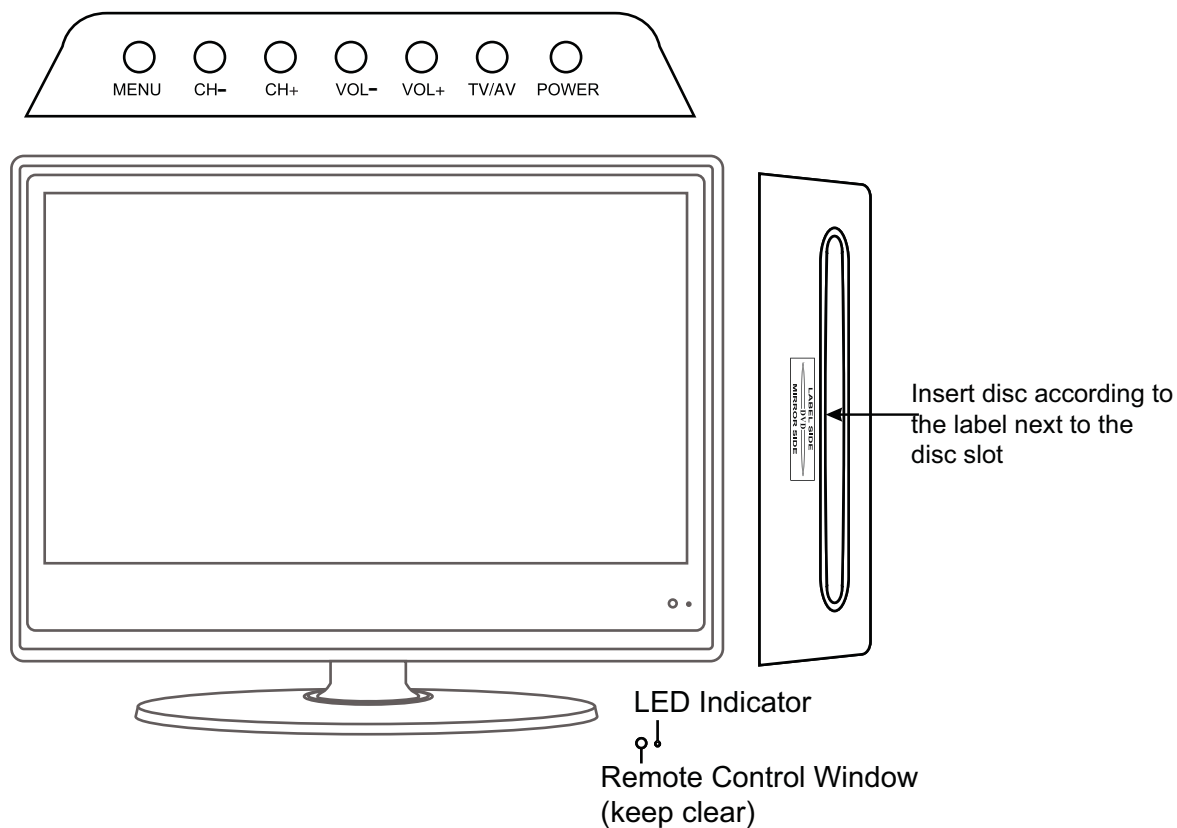

The functions of the TV buttons are described below.

Menu : Press to display the OSD menu, press again to exit the menu.

CH+/- : Press to skip through the channels.

Vol +/- : Press to adjust the volume.

TV/AV : Press to display the input source menu.

Power : Turn ON/OFF the TV set.

The functions of the DVD buttons are described below.

EJECT : Eject.

PLAY : Play.

Unit and Accessories (continued)

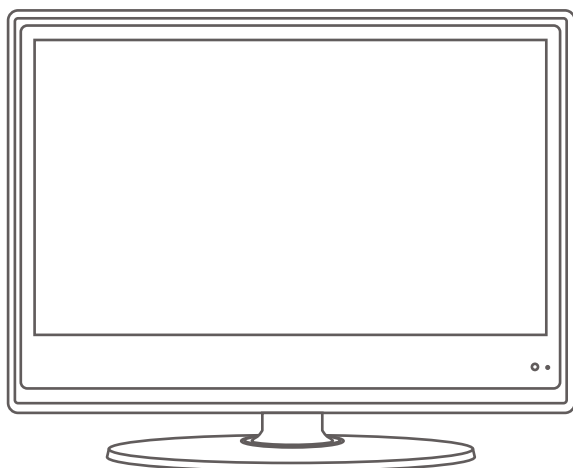

TV set



Remote Control



Batteries



Power cable

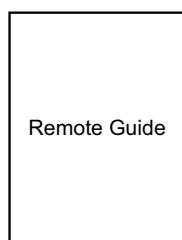

Remote Guide



Quick Start Guide

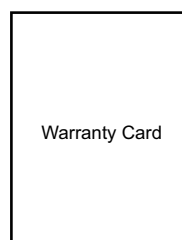

Warranty Card

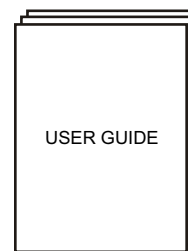

User Guide

Remote control

- Functions of remote control buttons

Dependant on the model of the TV some keys will have no function

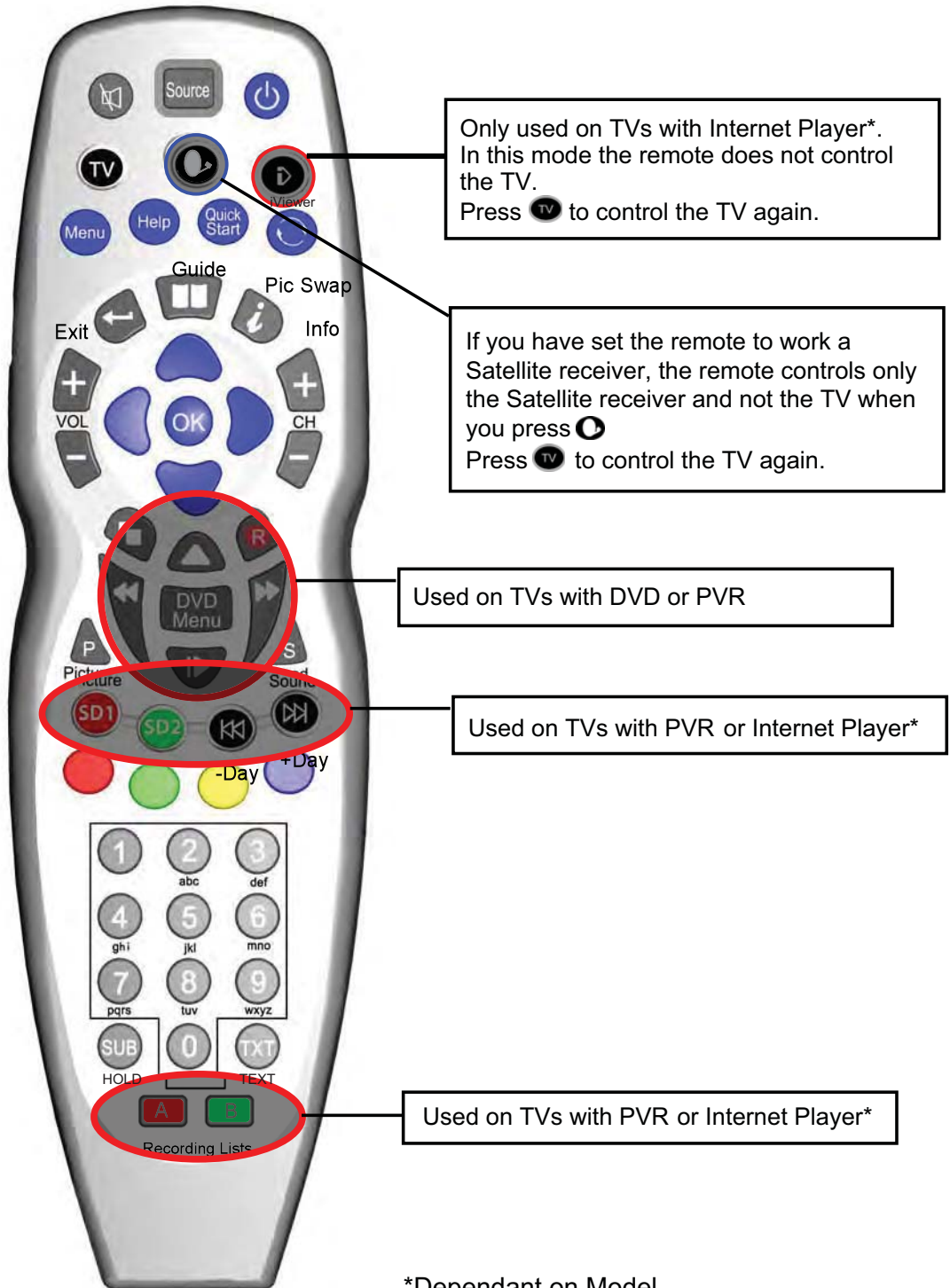

Remote control (continued)

Dependant on the Model of the TV some keys will have no function

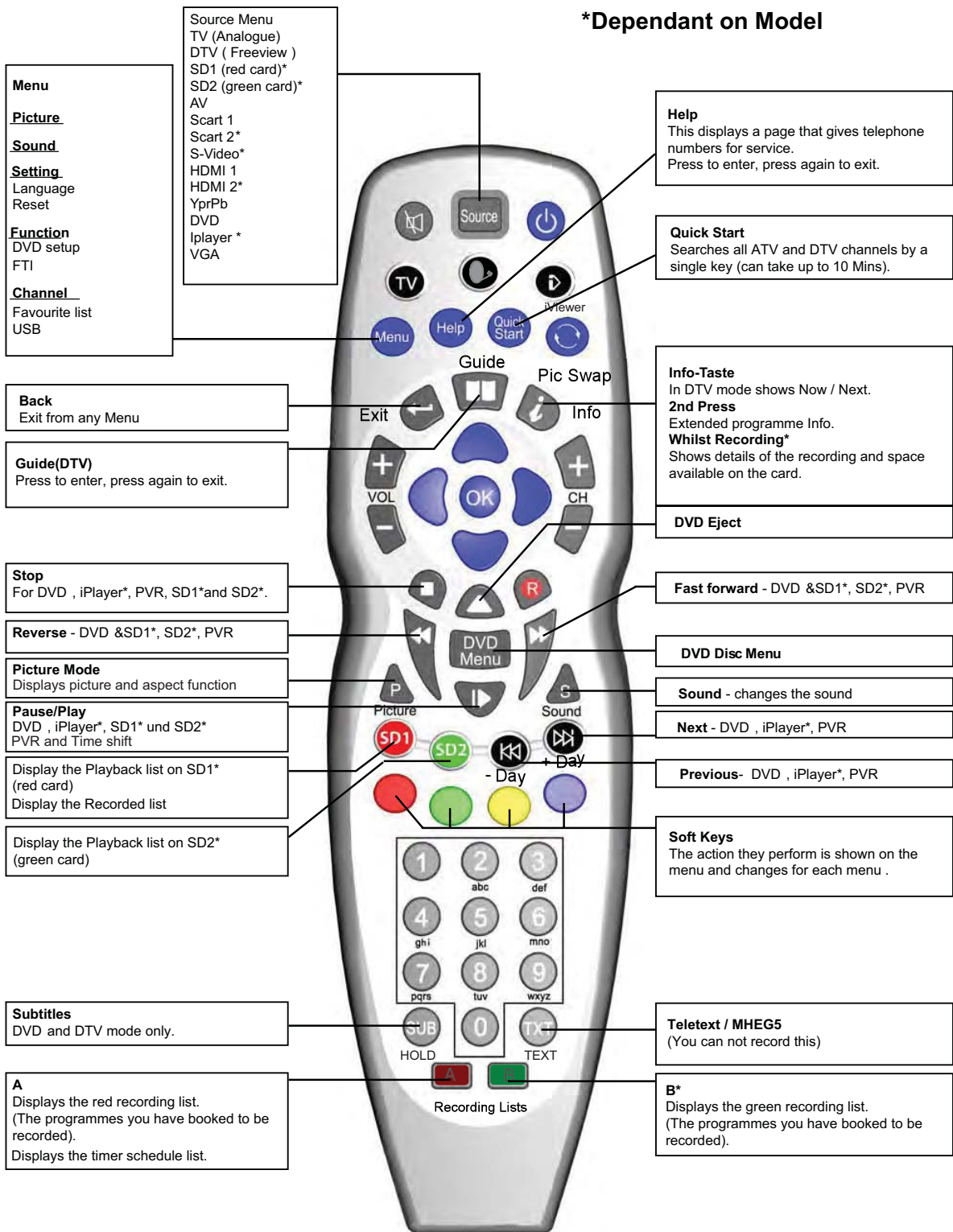

Remote control (continued)

Dependant on the model of TV some keys will have no function

*Dependant on Model



TV This button puts the Remote in TV control mode

Sat This button puts the Remote in a Multi Satellite control mode

* A number of modes are available. See below for details

Internet Player This button puts the Remote into an Internet Player mode

*This is only used on some TVs and Digital Boxes

To Set the Multi-Satellite Mode button

The Sat button  is programmable in the remote and can be set as follows:





To set the button if you have no Satellite Receiver:
Press  and at the same time press 0

If you have a Satellite Receiver with Recorder (Known as "Plus" type)
Press  and at the same time press 1

If you have a Satellite Receiver with High Definition (Known as "HD" type)
Press  and at the same time press 2

If you have a normal Digital Satellite Receiver (Known as "Digital" type)
Press  and at the same time press 3

If you want to use this button to switch on the DVD Player
Press  and at the same time press 4
DVD Player only fitted on certain models.

- | | |
|---|-----------------------|
|  | + 0 ~ NO SAT RECEIVER |
|  | + 1 ~ SAT + |
|  | + 2 ~ SAT HD |
|  | + 3 ~ SAT DIGITAL |
|  | + 4 ~ DVD |

Remote control (continued)

Installing Batteries in the Remote Control

1. Remove the battery compartment cover at the rear of the remote control by pushing the retaining clip forward and pulling up.
2. Install the supplied batteries, ensuring the polarity matches what is shown in the battery compartment.
3. Replace the battery compartment cover.

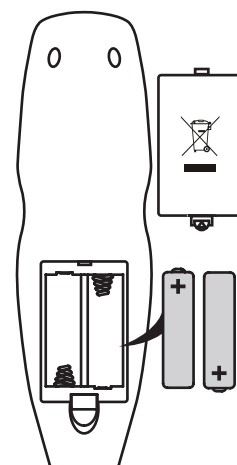

Using the Remote Control

To use the remote control point it at the TV and press the required buttons. You must be within 6 meters and at an angle of less than 30 degrees from the center of the TV.

NOTE: Sunshine or other strong light sources may interfere with the signal from the remote control. In this situation turn the TV away from the light source.



WARNING! DO NOT LEAVE BATTERIES IN THE REMOTE CONTROL FOR EXTENDED PERIODS AS THEY CAN LEAK OR CORRODE CAUSING DAMAGE TO THE REMOTE CONTROL. CHECK THEM PERIODICALLY AND REPLACE THEM AS REQUIRED.



WARNING! DO NOT MIX BATTERY TYPES. WHEN INSERTING BATTERIES, REPLACE ALL BATTERIES AT THE SAME TIME. DO NOT MIX OLD AND NEW BATTERIES.



WARNING! EXHAUSTED BATTERIES MUST BE TREATED WITH CARE AND DISPOSED OF ACCORDING TO ANY SAFETY OR RECYCLING REGULATIONS IN FORCE IN YOUR LOCAL AREA, NEVER DISPOSE OF BATTERIES INTO GENERAL WASTE, OR FIRE.



WARNING! NEVER EXPOSE BATTERIES TO EXCESSIVE HEAT SUCH AS SUNSHINE, FIRE OR THE LIKE.

Aerial connection

WARNING! ENSURE THE TV AND ALL ANCILLARY EQUIPMENT IS UNPLUGGED FROM THE MAINS BEFORE MAKING ANY CONNECTIONS!

Connecting the TV Antenna

Connect the TV antenna to the aerial socket with a 75 ohm co-axial plug. For best results use a high gain TV aerial, preferably roof or loft mounted.

- To improve picture quality in a poor signal area, purchase and install a signal amplifier.
- If the antenna needs to be split for two TVs, use a 2-Way Signal Splitter (not supplied).

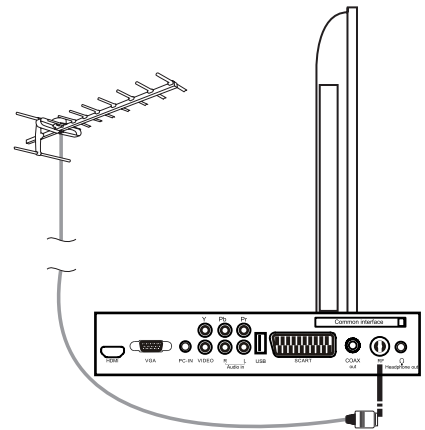

Connecting external devices

This instruction manual shows the simplest and most effective way of connecting your TV to ancillary equipment. Alternate methods are listed below.

HDMI Lead

You can connect this TV to a compatible device using a HDMI lead. This method will give the best picture.

Connect the cable from the HDMI equipment to the TV HDMI socket.

SCART Lead

You can connect this TV to a compatible device using a SCART lead. The connection uses component video signals, i.e. the red, green and blue (RGB) content of the video are sent on separate signals.

VGA Cable

You can use your TV as a monitor for your personal computer by using a VGA cable. Sound from your personal computer may also be played through the TV.

Connecting external devices (continued)

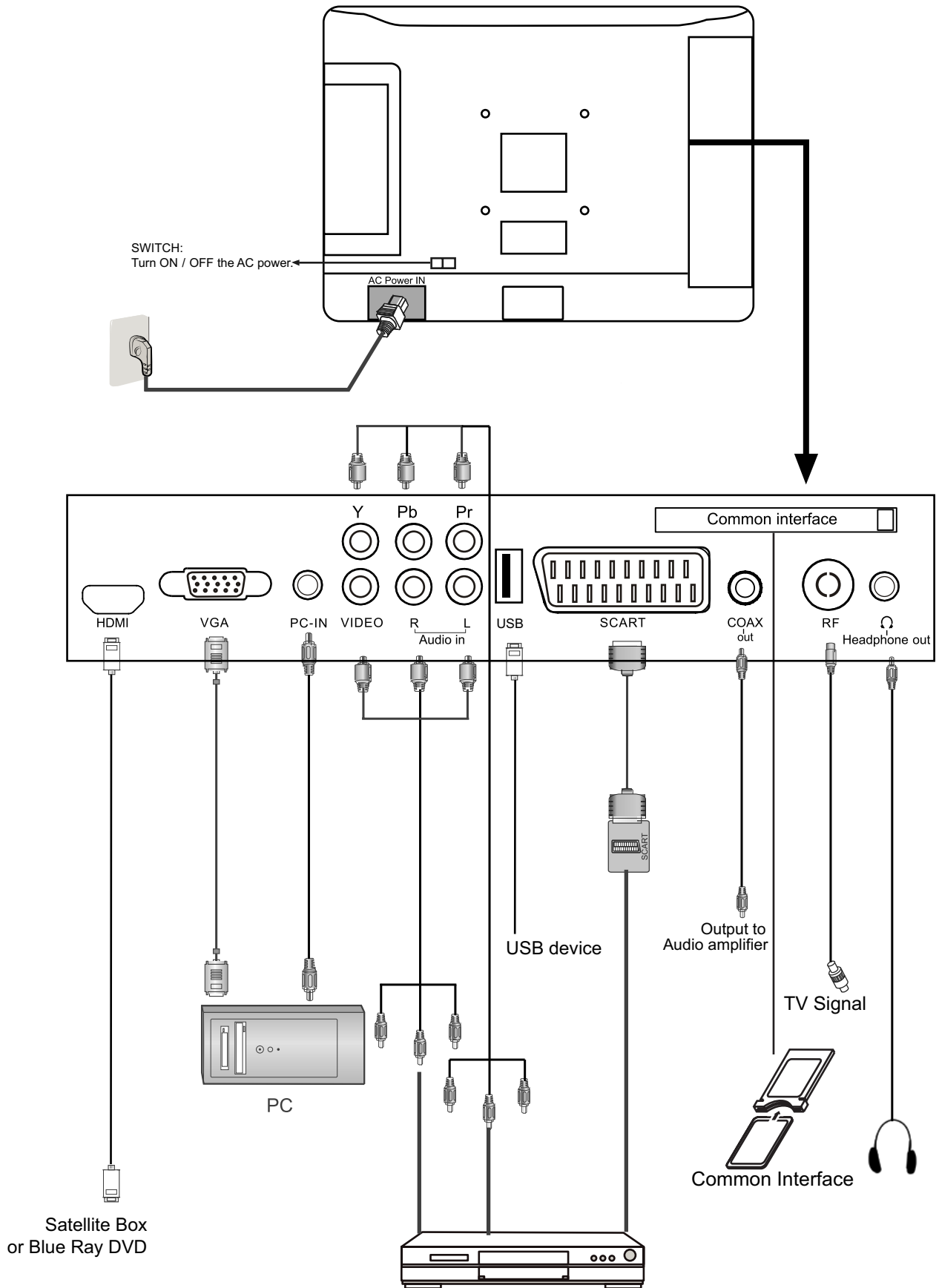

Connecting external devices (continued)

CONNECTIONS

Name	Function Description
AC POWER IN	Connect to power supply
HDMI	Connect to the HDMI socket of your DVD or Satellite Box
VGA	Connect to the PC VGA output to display PC graphics
PC-IN	PC audio input
YPbPr	Connect to the YPbPr output on external devices
Video	Connect to the video output of external devices
(AUDIO)L/R IN	Audio signal input for AV(Shared with YPbPr)
USB	Connect to USB device for multimedia
SCART	Connect to the scart input / output of external devices
Coax-out	Output to audio amplifier
RF	Connect to antenna or cable source
Ω Headphone	Connect Headphone
CI	CI slot (pay as you view card slot)

Caution:

Before connecting external devices:

- Makes sure to disconnect the appliances from the power supply in order to avoid any potential damage from occurring.
- Make sure to establish the required connection.
- Make sure that the connectors are properly and correctly attached before connecting the appliances to the power supply.

Connecting external devices (continued)

PC connection

As PCs are sometimes still supplied with a 'conventional' CRT monitor, you may need to adjust the display settings of your PC's graphics card, otherwise the pictures may not appear correctly. Switch on your PC (still with your original monitor connected) now select the screen resolution, and select 60Hz refresh rate. Switch off your PC, then connect it to your TV while both appliances are still switched off.

VGA, HDMI PC Connection

Use a PC-VGA cable (not supplied) to connect the TV to your PC. You can also use an HDMI cable to connect to your PC (if your PC Graphic card supports HDMI). When the HDMI cable is used, the PC audio cable is no longer required. If you use the HDMI to DVI cable, you will need to use the PC audio cable. Connect all cables carefully and do not bend or break the connector pins.

When using the VGA cable

- Switch on the TV
- Switch on the PC
- Select PC/VGA as input source

When using the HDMI cable

- Select HDMI as input source

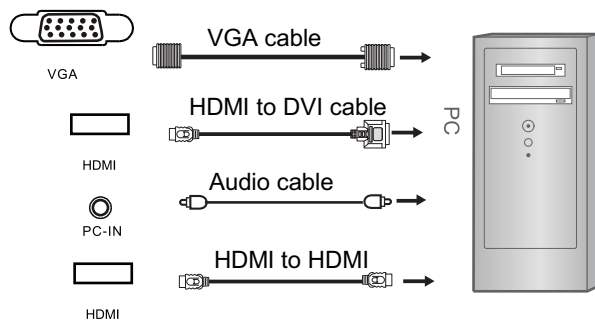

(All illustrated cables are not supplied)

Connecting external devices (continued)

Connecting Video camera and Video recorder

Video camera

- Connect the AV cable to the TV and to the video camera.
- Turn on both video camera and the TV.
- Select AV/CVBS source
- You can now see the playback picture from the video camera.

Note:

- To connect the video camera using other cables, refer to the video camera instruction manual.

Video recorder

- Connect the Scart cable to the TV and video recorder.
- Turn on both video recorder and the TV.
- Select Scart source
- You can now see the playback picture from the video recorder.

Note:

- To connect the video recorder using other cables, refer to the video recorder instruction manual.

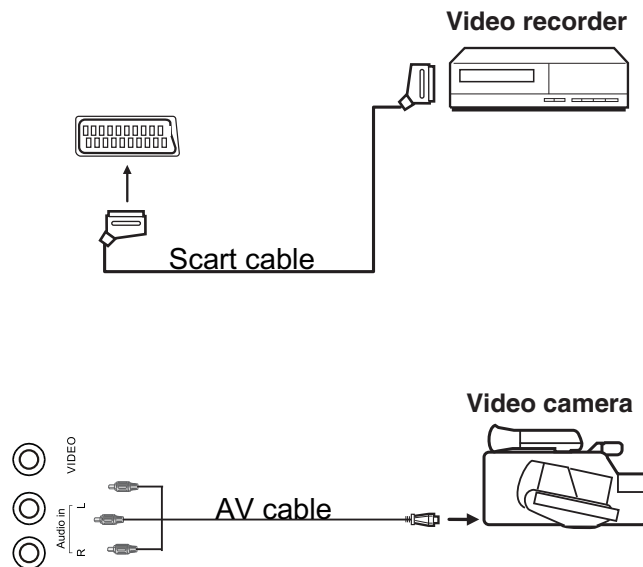

(All illustrated cables are not supplied)

Connecting external devices (continued)

Connecting an audio system

You can supply the TV sound to the stereo system (A) with the Scart socket. Use a special scart cable SCART to RCA. (Please consult your hi-fi instructions for details). If you have a surround sound amplifier/decoder (B) Use the Scart cable or the special scart cable Scart to RCA.

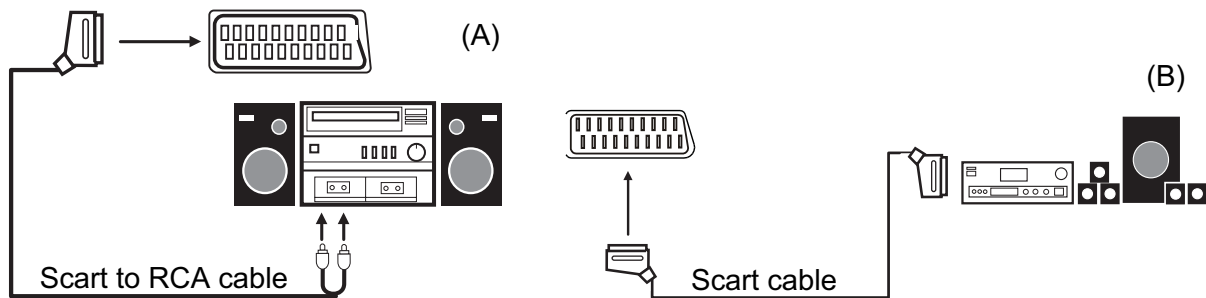

(All illustrated cables are not supplied)

Connecting a DVD player

Connect a DVD player using either a SCART cable or the HDMI cable.
(only if your external equipment supports HDMI).

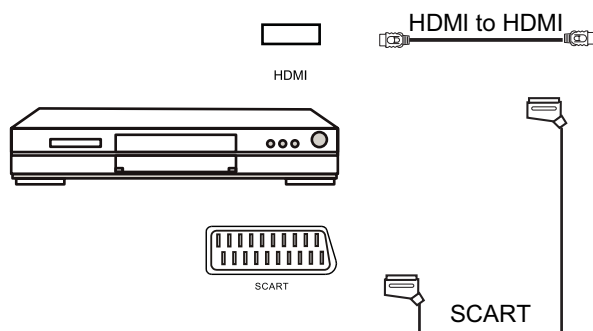

(All illustrated cables are not supplied)

When using the SCART cable

- Switch on the TV
- Switch on the DVD player
- Select SCART as input source

When using the HDMI cable

- Select HDMI as input source

Common Interface Slot

USING YOUR COMMON INTERFACE SLOT

Common Interface

The Common Interface (CI) slot is designed to accept the Conditional Access Module (CAM) and Smart Card in order to view the pay TV programmes and additional services. Contact your Pay Per View TV service provider to get more information about the modules and subscriptions.

NOTE: Conditional Access Module and Smart Cards are sold separately.

WARNING! SWITCH OFF YOUR TV BEFORE ANY MODULE IS INSERTED INTO THE COMMON INTERFACE SLOT, THEN ADD THE SMART CARD TO THE CAM.

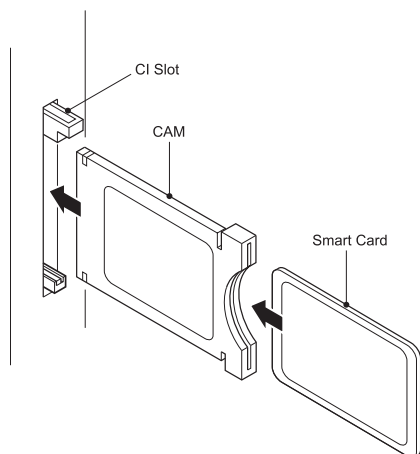

1. Turn on the TV and ensure 'DTV' Source is selected.
2. If the CAM is detected the TV will display the following message on the screen. "Common Interface Module inserted" wait for a few moments until the card is activated.
3. Select the relevant digital Pay Per View channel.
4. Detailed information on the Smart Card in use is displayed
5. Press the Ok button to access the card menu. Refer to the Module Instruction Manual for setting details.
6. When the module is removed, the following message will appear on the screen. "Common Interface module removed".

Auto installation setup

Power On / Off the LCD TV

Power Switch On / Off 

Press the power switch to setting  and the standby indicator will light red.

To turn on the LCD TV



Press the power button on the LCD TV or the  button on the remote control, the standby indicator will light green.

To turn off the LCD TV

Press the power button on the LCD TV or the  button on the remote control, the standby indicator will light red.

To turn the LCD TV off completely press the power switch to setting  and the standby indicator light will extinguish.

When you initially turn on the LCD TV you will see the first time installation menu as below:

Ensure that the aerial is plugged in to the TV, Make sure your Remote is in TV mode (by pressing  button), switch on the TV by pressing . You will see the first time installation menu.

Press the  button on the remote control to start the tuning procedure. This process will find all available ATV and DTV channels and store them.

By pressing the Quick Start button the first time installation can be recalled at any time.

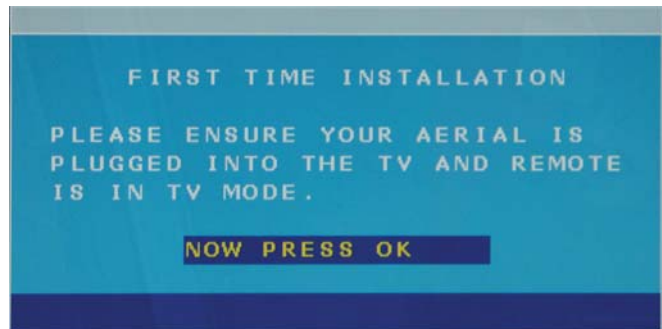

Source Menu

You can select the input source menu by pressing the Source button on the remote control or the TV / AV button on the LCD TV.

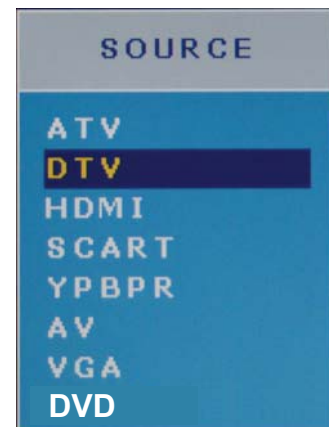
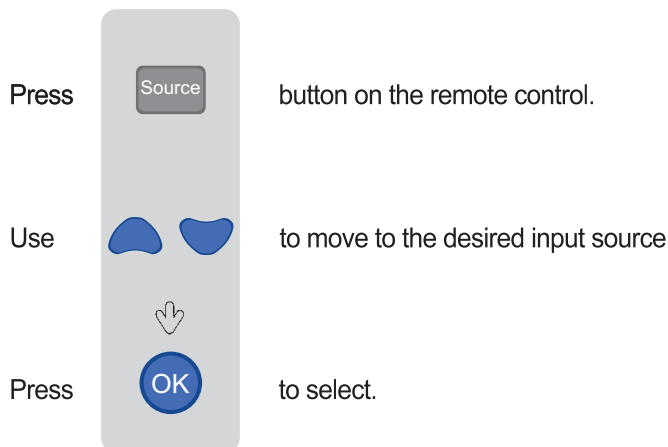

Menu Settings

1. Turn the LCD TV on.
2. Press the MENU button on the Remote Control.
3. Use the ◀ and ▶ buttons to navigate through the menu.
4. Press the EXIT button to exit the Menu.

CHANNEL MENU

Allows you to search channels and set up a variety of channel options.



PICTURE MENU:

Allows you to make adjustments to your picture settings.



SOUND MENU:

Allows you to customize the sound options and effects.



SETTING MENU:

Allows you to setup a variety of setup options.



FUNCTION MENU:

Allows you to set up a variety of lock/time and setup options.



Note: Use the left right up down navigation buttons to select the required options in the menus.

Menu Settings (continued)



Use the ◀ and ▶ buttons to select the **CHANNEL** menu (as the picture above), press ▼ button to enter the menu.

The CHANNEL menu includes the following options :

Country	Press ◀ and ▶ buttons to select the Country. (Can be selected in ATV mode)
---------	---

Auto Search	Press ▶ button to start auto search.
-------------	--------------------------------------

Auto Search menu for DTV

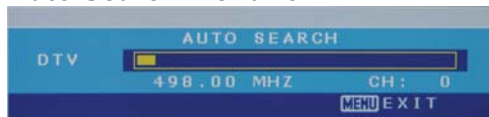

Auto Search menu for ATV



Manual Program	Press ▶ button to enter the submenu.
----------------	--------------------------------------

Manual Program menu for ATV



Program	Select the program you want to edit.
Color Sys.	Select the color system for the program you want to edit.
Sound Sys.	Select the sound system for the program you want to edit.
Manual Search	Use ◀ and ▶ button to manual search.
AFT	Turn on/off the Auto Frequency Tuning function for Manual Search.
Fine	Use ◀ and ▶ button to fine-tune.
Skip	Select "Yes" to skip the program when you scan the programs by CH+/-.

Menu Settings (continued)

Manual Program menu for DTV



Program	Select the program you want to edit.
Start Search	Press ► button to start search.
Channel Found	Display the channel found.
SIG. Quality	Display the signal quality of the channel found.
SIG. Strength	Display the signal strength of the channel found.
Frequency	Display the frequency of the channel found.

Program Edit: Press ► button to enter the submenu as the following picture.

Program Edit menu for ATV



NAME: Select the channel, press GREEN button on the remote control to change the name of the channel.

(Use ◀ ▶ ▼ ▲ button to name, and press OK button to confirm)

LOCK: Select the channel, press RED button to lock the channel. You have to enter the code to view the channel you have locked.

Note: you could set the code in System Lock menu in FUNCTION menu, the original code is 0000.

INSERT: Select a channel you want to insert, press YELLOW button, then select the position, press GREEN button to insert, or you could press RED button to cancel the option.

Program Edit menu for DTV



Lock: Select the channel, press BLUE button to lock the channel.

Delete: Select the channel, press RED button to delete the channel.

Move: Select the channel you want to move, press GREEN button, and move the channel by ▼ ▲ button, confirm the option by OK button.

Rename: Select the channel, press YELLOW button to change the name of the channel. (Use ▼ ▲ ◀ ▶ button to name, and press OK button to confirm)

CI MENU(in DTV mode)

Please contact your “pay perview” provider who can supply a viewing card and cam unit with instructions for their use.



Menu Settings (continued)

Favourite List Press ► button to enter the Favourite List.

USB Press ► button to Multimedia menu.

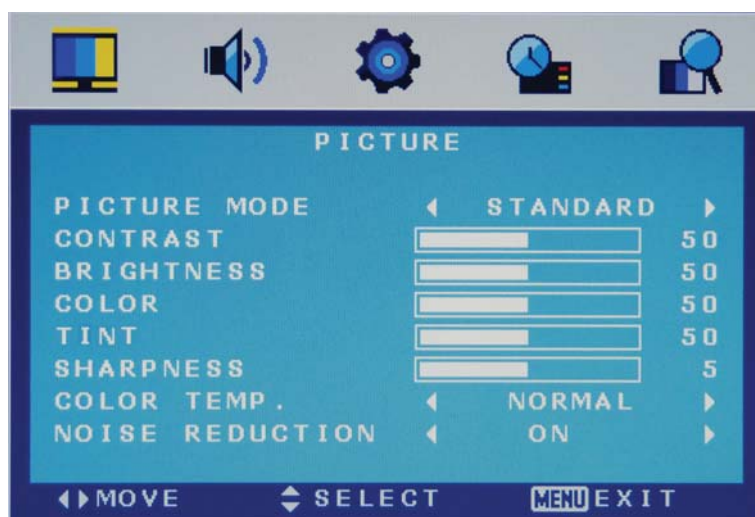

Use the ◀ and ▶ buttons to select the **PICTURE** menu (as the picture above), press ▼ button to enter the menu.

The PICTURE menu includes the following options :

Picture Mode	Choose from Standard, Movie, Vivid and Personal.
Note: Contrast, Brightness, Color and Sharpness can only be adjusted in the Personal mode option in the Picture Mode Settings.	
Contrast	Controls the difference between the brightest and darkest regions of the picture.
Brightness	Controls the overall brightness of the picture
Color	Control the color.
Sharpness	Increase this setting to see crisp edges in the picture; decrease it for soft edges .
Tint	Controls the tint (NTSC mode only).
Colour Temp.	Choose from Normal, Cool, and Warm.
Noise Reduction	Reduce any interference noise by selecting "ON". (Can be selected in ATV mode).

Menu Settings (continued)



Use the ◀ and ▶ buttons to select the **SOUND** menu (as the picture above), press ▼ button to enter the menu.

The SOUND menu includes the following options :

Sound Mode	Allows you to select among: Standard, Music, Movie and Personal.
Bass (Can be adjusted when the sound mode is set to User)	Controls the relative intensity of lower pitched sounds.
Treble (Can be adjusted when the sound mode is set to User)	Controls the relative intensity of higher pitched sounds.
Balance	To adjust the balance of the left and right sound track, or turn off the volume of the left and right sound track.
AVL	Control the volume of the program automatically when you turn on the function by selecting "On".

Menu Settings (continued)



Use the ◀ and ▶ buttons to select the **SETTING** menu (as the picture above), press ▼ button to enter the menu.

The SETTING menu includes the following options:

Language	Allows you to select menu language.
OSD Timer	Allows you to select the time for OSD menu displays on the screen.
Transparence	Allows you to select the transparence for OSD menu displays on the screen.
Overscan	Turn on/off the overscan funciton. (Can be selected in HDMI mode)
Reset	Press ▶ button to restore factory default.

Menu Settings (continued)



Use the ◀ and ▶ buttons to select the **FUNCTION** menu (as the picture above), press ▼ button to enter the menu.

The FUNCTION menu includes the following options :

Sleep Timer	Allows you to setup the sleep timer to : 15min, 30min, 45min, 60min, 75min, 90min,105min, 120min and off.
Aspect	Allows you to select the screen display mode. (Can be selected in DTV mode)
TT Language	Allows you to select the Teletext language. (Can be selected in ATV mode)
Blue Screen	Turn on the blue screen display in no signal state by selecting "ON" (Can be selected in ATV mode)
System Lock	Press ▶ button, and enter the code to enter the submenu. The original code is 0000.



System Lock	Turn on/off the system lock function.
Child Lock	Lock the channel, you have to enter the code to view the channel.
Key Lock	Lock the buttons on the TV set.
Parental	Select the parental control mode.
Change Code	Change the code.

FTI (First Time Installation) Press ▶ button to enter the First Time Installation menu.

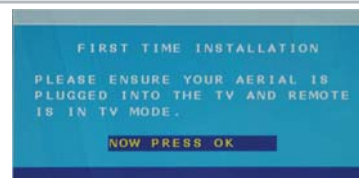

Menu Settings (continued)

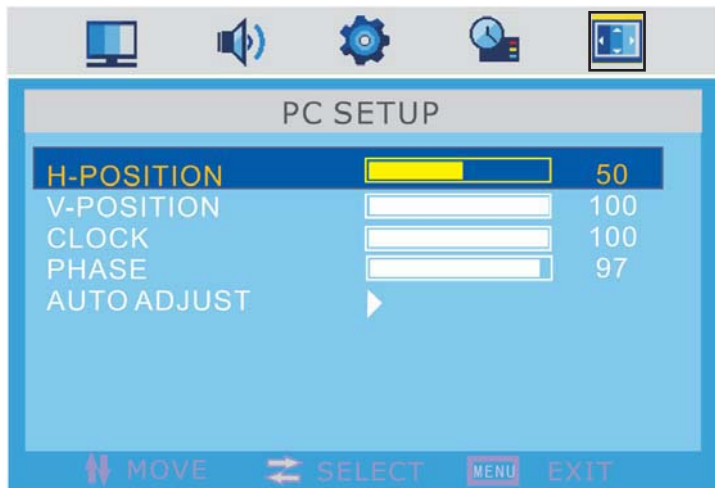

Use the ◀ and ▶ buttons to select the **PC SETUP** menu (as the picture above), press ▼ button to enter the menu.

The PC SETUP menu includes the following options :

H-Position	Adjust the transverse position of the screen.
V-Position	Adjust the vertical position of the screen.
Clock	Adjust the pixel clock frequency, until the image size is maximized for the screen.
Phase	Adjust the phase of the ADC sampling clock relative to the sync signal, until a stable image is obtained.
Auto Adjust	Press ▶ button to setup the parameter of the screen automatically.

Multimedia Operation

Note: Insert USB device and select DTV mode.

Basic Operation

Press the MENU button on the remote control to display the main menu. Select the CHANNEL menu using the ◀ / ▶ buttons, then select USB using the ▼ / ▲ buttons. Finally press the ▶ button to enter the Multimedia menu seen below.

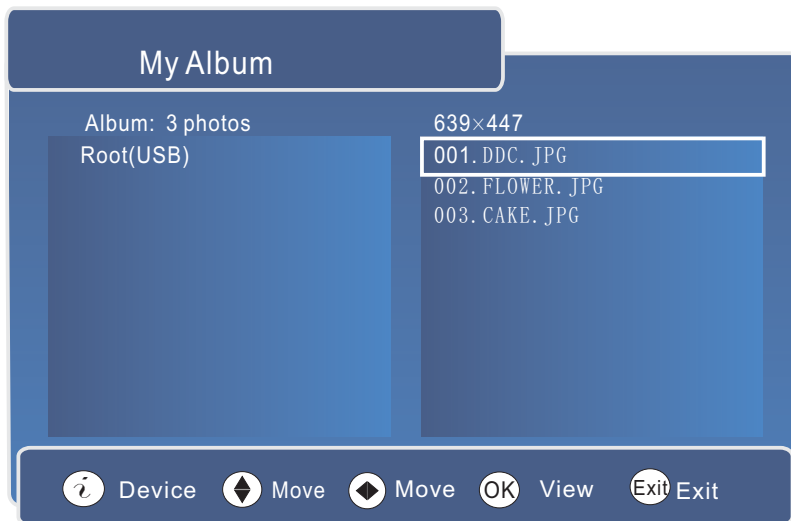
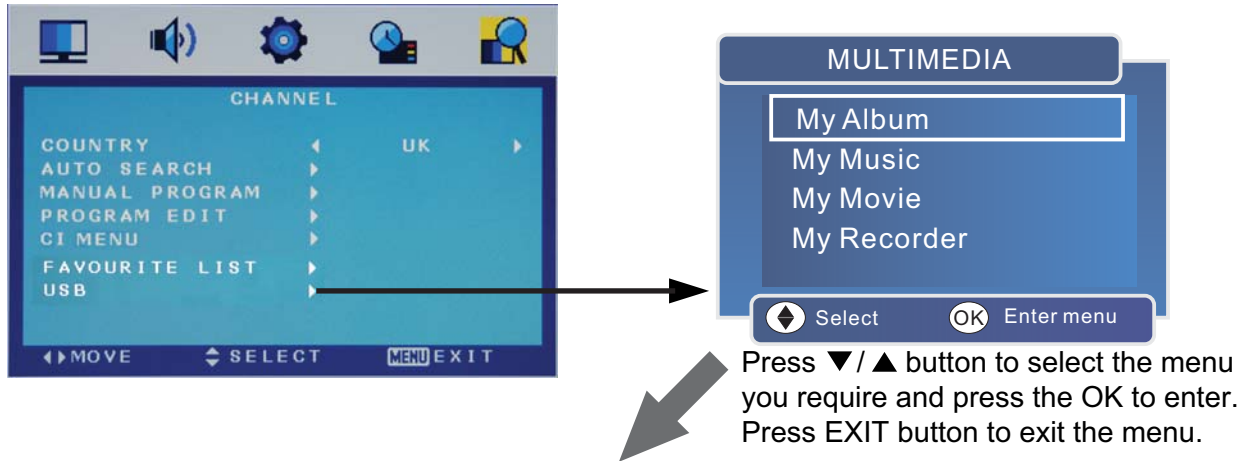

Note1: Navigate the menu according to the descriptions at the bottom of the menu.

Note2: Press MENU button to return to the previous menu.

Multimedia Operation (continued)

1. My Music menu

Select the music file

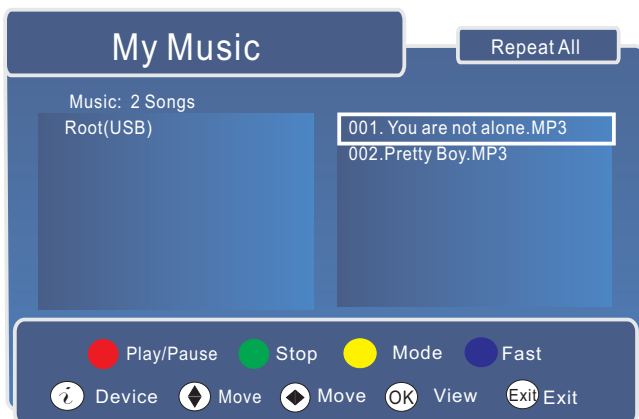

Play the music

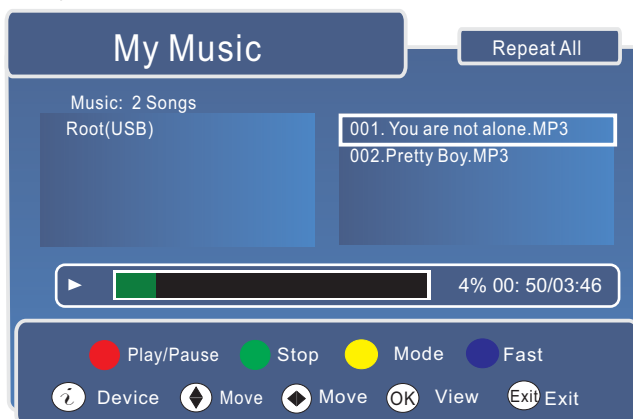

Press ◀/▶ buttons to select folder or music files, press the ▼/▲ buttons to select the required music file then press OK to play the file.

- Play/Pause : Press the RED button on the remote control to start the music, press again to pause.
- Stop : Press the GREEN button on the remote control to stop and end the music track.
- Mode : Press the YELLOW button on the remote control to repeat one or all files.
- Fast : Press the BLUE button on the remote control to play fast forward.

2. My Album menu

Select the photo



Use ▼/▲/◀/▶ buttons to select the photo you want to view, press the OK button to view the photo full screen. To return to My Album menu press the Menu button. If a file cannot be located press the blue (Folder) button and search other folders.

Multimedia Operation (continued)

Picture View

Select the photo, and press **OK** button to view as the picture below:

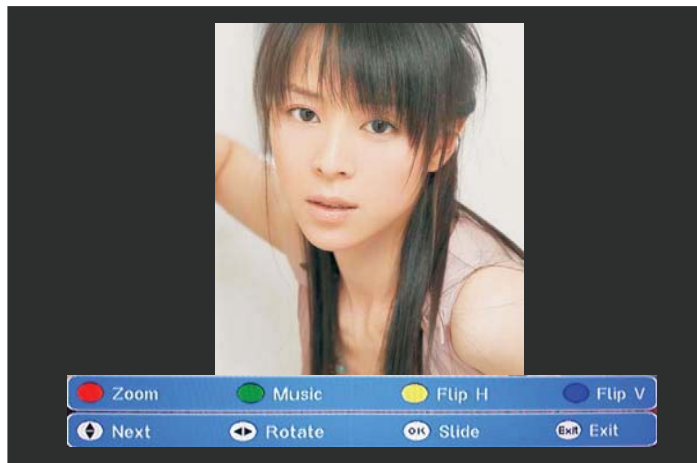

Press **▼ / ▲** button to view the previous/next photo.

- **Zoom**: Press the **RED** button on the remote control to zoom photo on the screen, when the photo is larger than full-screen, press **▼ / ▲ / ◀ / ▶** button to move.
- **Music**: Press the **GREEN** button on the remote control to display the music files and you can add music for when you view the photos.
- **Flip H**: Press the **YELLOW** button on the remote control to flip the photo horizontally.
- **Flip V**: Press the **BLUE** button on the remote control to flip the photo vertically.

3. My Movie menu

Select the movie file

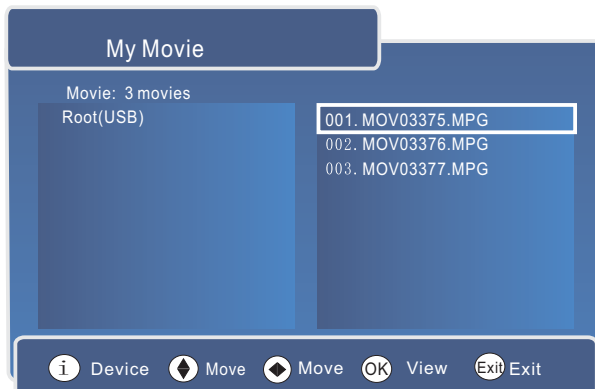

Play the movie

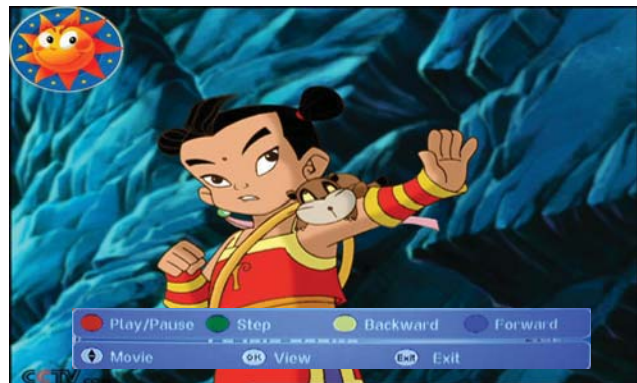

Press **◀ / ▶** button to select the Movie files, press the **▼ / ▲** buttons to select the required Movie file then press **OK** to play the file.

- **Play/Pause**: Press the **RED** button on the remote control to pause the movie playing, press again to continue.
- **Stop**: Press the **GREEN** button on the remote control to one-step-play, press **BLUE** button next, you can set slow-forward speed to see the movie.
- **Backward**
- **Forward**

Multimedia Operation (continued)

4. My Record menu



Press ▼/ ▲ button to select the item, and press **OK** button to enter the submenu, or press **MENU** button to **MULTIMEDIA** menu.

Recorded List

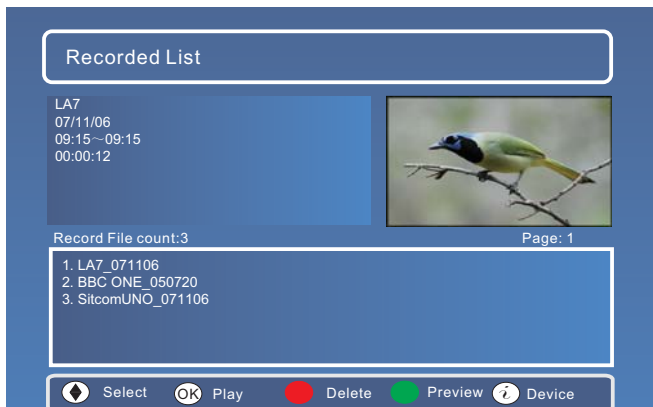

Press ▼/ ▲ button to select the recording you want to view, and press **OK** button to play in the small window, and press again to play in full-screen. Press **MENU** button to stop and back to the **Recorded List**.

You can press SD1 button on the remote control to display the Recorded list.
You can press A button on the remote control to display the Shedule list.

Note1: Use the ◀ / ▶ buttons to turn pages in the list.

- Press the **RED** button on the remote control to delete the selected recording. A message will be displayed as shown on the picture to the right. Press the **OK** button to confirm or **MENU** to cancel.

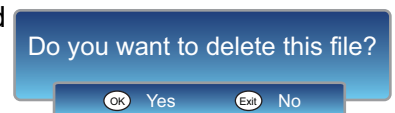

Note: When you start viewing a recording which you have already started previously but not finished, a message shown on the picture to the right will appear. Press ▲/ ▼ to select the option then press **OK** button to confirm.

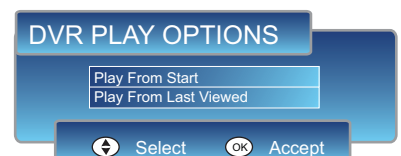

When you are playing the recording, you can press ►► button on the remote control to play fast-forward.

Press ◀◀ button on the remote control to play fast-backward, it will stop and play normally on the beginning;

Press ►|| button on the remote control to pause, press again to continue play normally;

Press ■ button on the remote control to stop and back to **Record List**;

Press ◀◀ / ►► button on the remote control to fast-forward/fast-backward by 10%.

Multimedia Operation (continued)

Recording Device

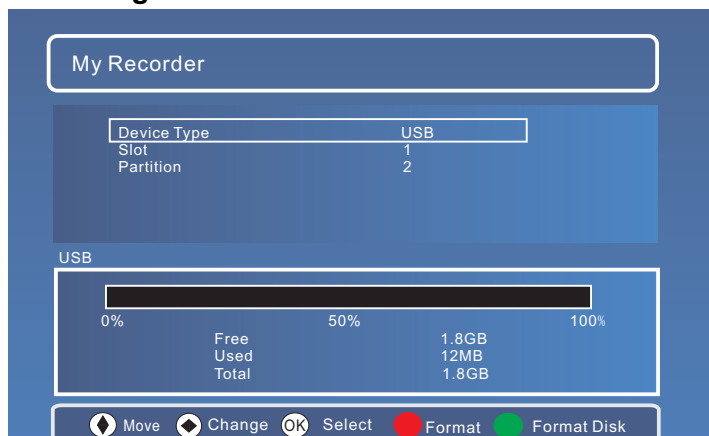

Press ▼/▲ button to select the item, and press ◀/▶ button to select, and press **OK** button to confirm and back to previous menu, or press **MENU** to cancel the setting and back to previous menu.

Device: Select USB device.

Slot: Select the slot when USB device selected.

Partition: Partition: Select the partition when USB device selected.

- Press the **RED** button on the remote control to format the device you selected, and it will display a message as the right picture, press **OK** button to confirm or press **MENU** button to cancel.

All data will be lost in current partition, format the partition?

OK Yes Exit No

- Press the **GREEN** button on the remote control to format the whole disc you selected, and it will display a message as the right picture, press **OK** button to confirm or press **MENU** button to cancel.

All data will be lost format the disk?

OK Yes Exit No

Recording Preference



Press ▼/▲ button to select the item, and press ◀/▶ button to select, and press **OK** button to confirm and back to previous menu, or press **MENU** to cancel the setting and back to previous menu.

Time Shift Size: Display the time shift size of USB device.

Time Shift: Select the Time Shift mode----OFF, Pause, AUTO. When you select Pause or AUTO, you can see the Time Shift as follows.



Multimedia Operation (continued)

One Button Recording: Turn ON/OFF the confirmation message before recording.

One Button Recording Period: Set the recording period. For example, when you set the time 02'45, recording will stop at 2 hours and 45 minutes.

Recording Operation

Press REC button on the remote control to start recording. If you have selected ON in the **One Button Recording** option, you will be prompted to set the Recording duration first. Press ◀ / ▶ button to set the duration time then press OK to confirm, press the Exit button to exit.



During recording, screen displays in full-screen, and the **Recording Time** will be display on the screen.

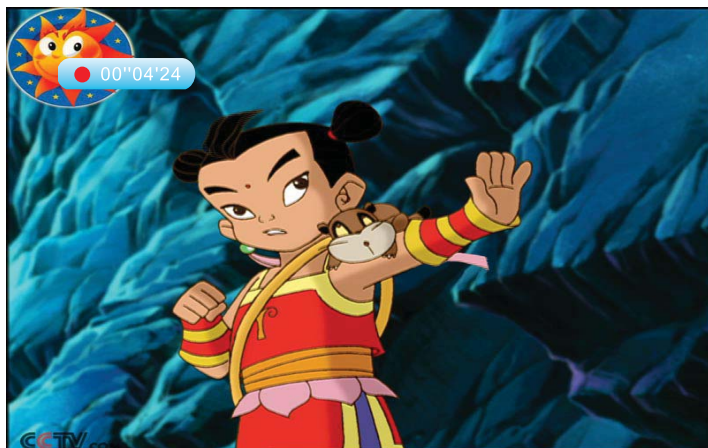

- Press ►► button on the remote control to play fast-forward.
- Press ◀◀ button on the remote control to play fast-backward.
- Press ►◄ button on the remote control to pause, press again to continue play normally;
- Press ■ button on the remote control to stop recording.

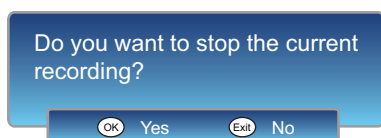

Press **OK** button to stop recording, press **MENU** button to continue.

Recording Operation (continued)

During recording enter the Time Shift mode, the screen display will appear as below.

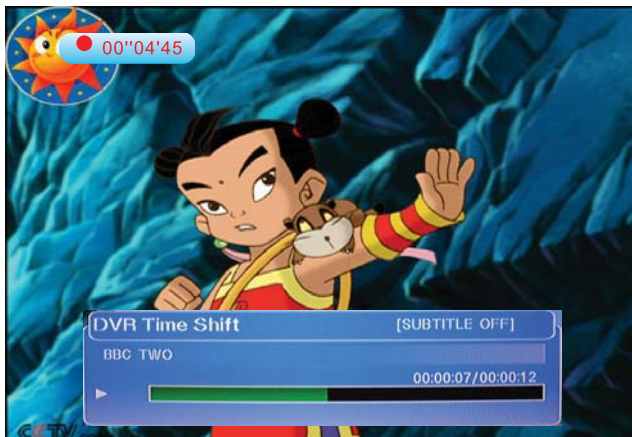

Note1: You may get a message as seen below and it will disappear automatically at once.

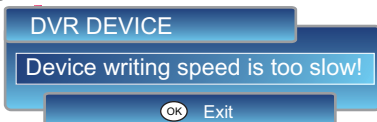

Note2: You may get a message as seen below if your recording stops for no reason.



Note3: When the recording is finishing a message will be displayed on the screen as below.

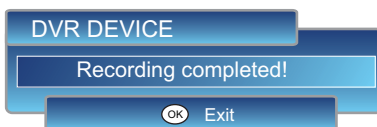

Note4: When the USB device has been extracted from the TV a message will be displayed as below.

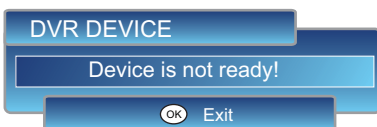

EPG menu



Display the programme guide by pressing the **GUIDE** button.

You can select a programme for recording using the **▼ / ▲ / ◀ / ▶** buttons.

To book a timer recording press the red button and the selected programme will be added to the Timer recording list. The booked programme will be outlined in red in the programme matrix.

When the programme starts it will be recorded to the USB device.

To set a reminder use the Green button. When the programme starts the TV will automatically switch to this programme.

Timer recording List

To display the list of programmes scheduled for recording, press the **A** button

List of Recorded Programms

To display the list of programmes already recorded on the USB press **SD1** button.

DVD Operation

Turn on your TV then use the Source button on the remote control or the TV/AV button on the TV to select DVD mode. If there is no disc in the DVD players the screen will show "NO DISC".

Place a disc

Insert a disc according to the instruction label next to the dvd insert slot.

Do not touch the playing surface.

Hold the disc around the outside with your fingers and place the disc into the slot. The player will automatically draw the disc into the player.

To "Eject" the disc, press the "▲" button on the TV or on the remote control.

Play

The contents of each disc vary, as to how the disc was authored and what features are included. Some discs start playing as soon as they have been read, some need "Play" selecting in the Menu. Different play modes are offered, such as Menu Play, Sequence Play and other modes.

Using the INFO Feature

1. Compatible with DVD, SVCD, VCD, CD, HD-CD, WMA, Digital Audio disc discs.

2. Loading and playing DVDs (two pages)

- Press INFO button once to show the first page:

- "Disc Type, Title * / * (the playing title / total titles), Chapter * / * (the playing chapter / total chapters), Elapsed Time of the Disc".

- Press the button again to show the second page:

- "Language */* (the serial number of playing language / the amount of optional languages) or Off, Language Type, Audio Type, Subtitle * / * (the serial number of playing subtitle /the amount of optional subtitles) or Off, Angle * / * (the serial number of playing angle / the amount of optional angles) or Off".

- Press the button for the third time, the INFO menu fades out.

3. Loading and playing SVCD discs (two pages)

- Press INFO button once to show the first page:

- "Disc Type, Track * / * (the playing track / total tracks), Mute, PBC, Repeat Mode, Elapsed Time of the Playing Track".

- Press the button again to show the second page:

- "Language * / * (the serial number of playing language/ the amount of optional languages) or Off, Language Type, Audio Type, Subtitle * / * (the serial number of playing subtitle / the amount of optional subtitles) or Off".

- Press the button for the third time, the INFO menu fades out.

4. Loading and playing VCD

- Press INFO button once to show the first page:

- "Disc Type, Track * / * (the playing track / total tracks), Mute, PBC, Repeat Mode, Elapsed Time of the Playing Track".

- Press the button again, the INFO menu fades out.

5. Loading and playing CD, HD-CD, WMA, Digital Audio / JPEG discs

- Press INFO button once to show the first page:

- "Disc Type, Track * / * (the playing track / total tracks), Mute, Repeat Mode, Elapsed Time of the Playing Track".

- Press the button again, the INFO menu fades out.

Subtitles

1. Compatible with DVD, SVCD discs.

2. Press the Subtitle button on the remote once, and the subtitle info banner appears

3. When a DVD or SVCD is recorded with subtitles, you can use the Subtitle feature to view the subtitles on-screen. By default, subtitles are off. The info banner will display Subtitle Off.

4. To display subtitles, press the Subtitle button again. The default language with its responding serial number will be displayed in the info banner and subtitles will be displayed in that language. There are 8 supported subtitles: Chinese, English, Japanese, French, Spanish, Portuguese, Germany and Latin. With each consecutive press of the Subtitle button, the subtitle switches.

For example, "Language Icon: [1 English DTS 6CH] or [Off]" (the availability of the subtitles are disc-dependent). To turn subtitles off, press the Subtitle button until Subtitle Off is displayed.

Digital Audio Disc

1. Compatible with Digital Audio discs
2. The player will search the disc directory automatically and display the contents on screen.
3. The player will then start to play the first track, of the selected directory.
4. To change directories use the direction buttons.

DVD System Operation

System operation will define the setting of the set; these definitions will be stored until you change them again.

General Steps of Setup Menu

1. Pause or Stop the player. Press **MENU** button on the remote control and select FUNCTION menu as below, then select **DVD SETUP**, press the OK button to enter the DVD main menu as below.

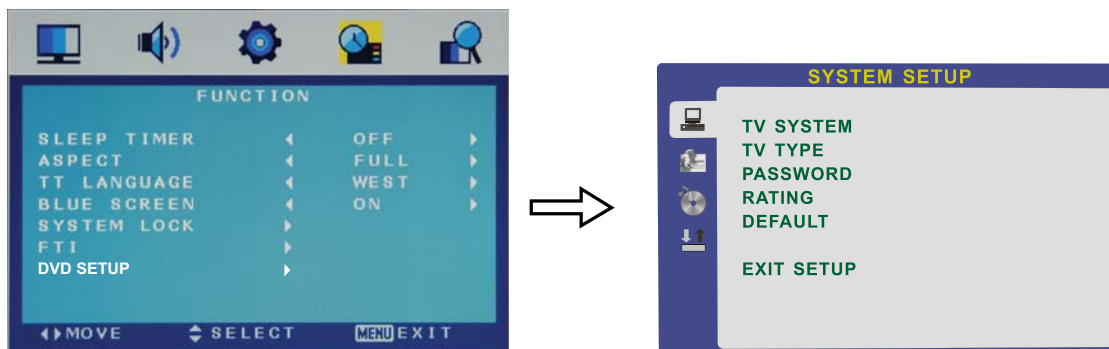

2. Press the \uparrow/\downarrow buttons to select the Icon of the desired section, e.g. "TV System" and press \Rightarrow button to open that section.
 3. Press \uparrow/\downarrow to select the desired feature and again press \Rightarrow button to open that section.
 4. Press \uparrow/\downarrow to select the desired feature and then press "OK" to select the new setting.
 - 5 To exit the menu, press or \downarrow to select EXIT SETUP and then press "OK"
- When launching the setup routine, the pressing of the following buttons will turn off the setup menu, while the choices that have been changed will be saved.

Menu specification

1. SYSTEM SETUP

The system setup options are illustrated below:

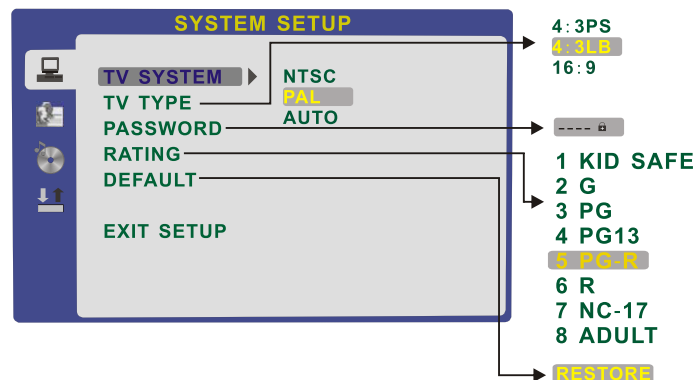

TV SYSTEM

According to the Color system of your TV, select proper TV TYPE.

PASSWORD

The password option is initialized as locked. You cannot set the ratings limit or change the password.

To enable these features you must unlock the Password. The default password is "0000". Using the \uparrow/\downarrow button, move the highlight to "PASSWORD", press the \Rightarrow button and enter "0000". You will see the padlock symbol open. You may now change the RATING or put in a new password number.

If the Lock symbol is BLUE you must press the \Rightarrow button to enter the lock field, the lock symbol will change to YELLOW, you may now enter a new 4 digit number. Please remember or write down the new Password and keep safe.

RATING

The Rating feature is a rating limit feature, like movie ratings. This helps you to control what DVD the family watches. There are 8 levels of selection, from KIDS SAFE to ADULT. Adult is the "play all" selection.

2. LANGUAGE SETUP

The language setup options are illustrated below:

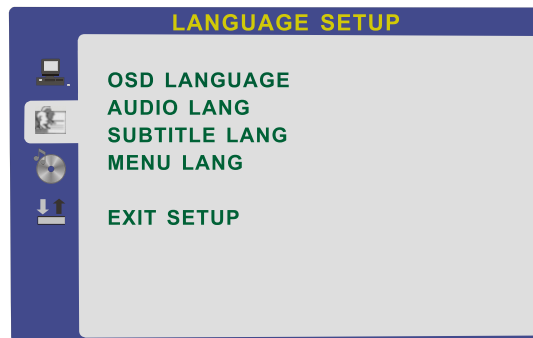

- OSD LANGUAGE: The OSD will display in the language you choose.
- AUDIO LANG: If the disc you are playing has the language you choose, it will output audio in that language.
- SUBTITLE LANG: If the disc you are playing has the language you require you may select this either in the Menu or using the "SUBTITLE" button on the Remote control. You may also switch this OFF.
- MENU LANG: If the disc you are playing has the language you require you may select this.

3. AUDIO SETUP

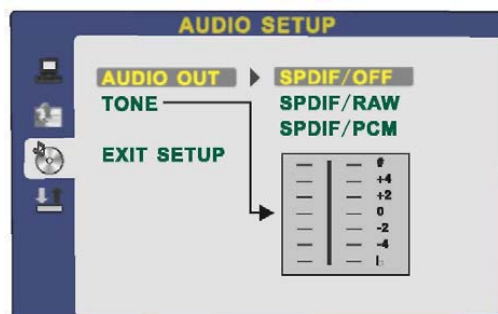

- Highlight the AUDIO OUT option, and press the \wedge/\vee buttons to choose the audio output mode you prefer. Press OK to confirm; There are 3 optional audio output modes: SPDIF /OFF, SPDIF / RAW, and SPDIF/PCM. SPDIF/ RAW is for amplifiers with a built in digital decoder. SPDIF/PCM is selected for amplifiers with no built in digital decoder.
- TONE: Use the \uparrow/\downarrow button to move the scroll and adjust the tone.

4. DIGITAL SETUP

The video setup options are illustrated below:

- DYNAMIC RANGE: Use the ↑ / ↓ button to move the scroll and adjust the dynamic range.
- DUAL MONO: Choose the mode of the audio output.
- There are four modes: STEREO, MONO L, MONO R, MIX MONO.

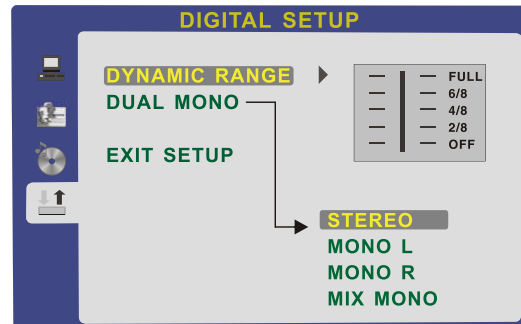

Disc Care

About Disc Terms

Title

Generally, pictures or music compressed on a DVD are divided into several sections, "title".

Chapter

The smaller section unit of picture or music in a DVD under the title, usually one title is comprised of one or more chapters and each of them is numbered for easy searching, but some discs may not have a recording chapter.

Track

A segment of picture or music on a CD, Each track is numbered for searching.

Care of Disc

Video disc contains high-density compressed data that needs proper handling.

1. Hold the disc with fingers by outer edge and/or the center spindle hole. Do not touch the discs surface.
2. Do not bend or press the disc.

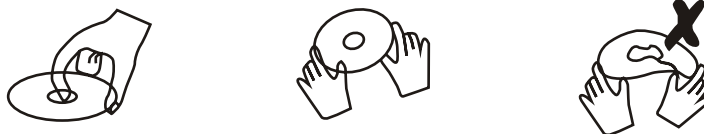

3. Do not expose the disc to direct sunlight or heating sources, Store discs in cabinet vertically, and in dry condition.

Prevent exposure to:

Direct sunlight

Heat or exhaust from a heating device

Extreme humidity

Clean the disc surface with a soft, dry cleaning cloth, Wipe the disc surface gently and radially from center toward the outer edge.

Do not apply thinner, alcohol, chemical solvent, or sprays when cleaning. Such cleaning fluids will permanently damage the disc surface.

TROUBLE SHOOTING GUIDE

To assist in locating possible faults use the help guide below.

SYMPTOM TROUBLESHOOTING

No Picture, no sound	Check that the TV is correctly plugged in. Check that the TV is connected to a suitable power source. Check the electrical supply is turned on.
No Picture	Ensure that the TV is powered on. Check that the cables are fitted securely. Ensure the aerial and/or external sources are connected. Press the SOURCE button to change the source. Turn the TV on or off.
No Sound	Press the MUTE button and check if Mute mode is set. Switch to another channel and see if the same problem occurs. Press V+ button to see if the problem can be solved.
No picture on some channels	Check that correct channel is selected Adjust the antenna.
No colour on some channels (black & white)	Check if the same problem exists on other channels. Ensure the correct picture settings are selected.
Noisy, Snowy, Ghosting picture.	Check the antenna is connected correctly. Check that the antenna is in good condition. Try moving the antenna.

If none of the suggestions seem to work, try switching your TV off and then on again. If this does not work contact our technical helpline 0871 288 7345.

NOTE: The TV must only be repaired by a qualified registered service person. Never attempt to remove the back cover as the TV has dangerous voltages inside that may cause fatality or fire.

TECHNICAL SPECIFICATIONS

Specifications of the TV that you have just purchased may vary from the information in this table due to technical innovations.

TV Specifications

TV System	PAL / BG / DK / I
Audio System	BG / DK / I
Screen size	19"(Diagonal)
Resolution	1440 x 900 Pixels(RGB)
Aerial input	75 Ω (unbalanced)
Audio output power	2 x 3W
Power requirements	100-240V ~ 50/60Hz
Power consumption	< 60W
Standby power consumption	<1W
Weight	4.60 kg

Remote control specifications

Type	Infrared
Control distance	5m
Control angle	30 degrees(Horizontal)
Batteries	2 x 1.5V, SizeAA
Dimensions	60 x 204 x 32mm
Weight	140g(without batteries)

Wall Mounting

1. The stand must first be removed. Place the TV face down.
2. Remove the one screw at the bottom underneath the stand. Press the two retaining clips forward using the thumb and forefinger to release the base of the stand. Remove the two screws inside of the trunk of the stand still attached to the TV. Remove the four screws on the back of the TV to release the remaining part of the stand.
3. Remove and store the stand and screws.
4. Use four machine screws to mount the TV on the bracket.

This unit is VESA-Compliant and designed to be wall mounted with a VESA-Compliant 100mm x 100 mm mounting kit. Mount this unit according to the instructions of the wall bracket (not supplied)

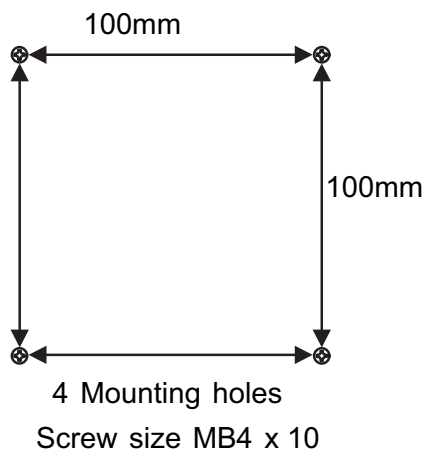

Waste Electrical Recycling

Correct disposal of Product



This sign indicates that this product may not be disposed of with your regular household waste. The recycling and separate collection of such products is your responsibility. Please drop off the above mentioned waste at a designated place for recycling waste electrical and electronic equipment. If you do not know where to drop off your waste equipment for recycling, please contact your local city office or household waste collection service.



The crossed out wheeled dust bin symbol indicates that batteries and /or accumulators must be collected and disposed of separately from household waste.

If the battery or accumulator contains more than the specified values of lead (Pb), mercury (Hg), and/or cadmium (Cd) defined in the Battery Directive (2006/66/EC), then the chemicals symbols for lead(Pb), mercury (Hg) and/or cadmium (Cd) will appear below the crossed out wheeled dust bin symbol.

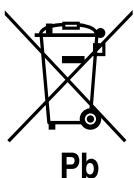

By participating in separate collection of batteries, you will help to assure the proper disposal of products and batteries thus help to prevent potential negative consequences for the environment and human health.

For more detailed information about the collection and recycling programmes available in your country, please contact your local city office or the shop where you purchased this product.



This appliance complies with European Safety and Electrical directives.