

Full HD LED TV with Freeview HD & USB Media Player

User Guide



Model No
50/238F

Important Safety Instructions

IMPORTANT - Please read these instructions. All the safety and operating instructions should be read before the appliance is operated.



Warnings

- To reduce the risk of fire, electric shock or damage to the television, do not expose it to dust, rain or moisture, or place any objects filled with liquids on or near the television.
- Do not place the television in a confined space. Ensure that nothing can obstruct the ventilation openings at the rear of the television.

To prevent the spread of fire, keep candles or other open flames away from this product at all times



- Dispose of this television and any components including batteries in an environmentally friendly manner. If in doubt, please contact your local authority for details of recycling.

Safety

- For your safety, this appliance is fitted with a fused moulded 3 pin mains plug. Should the fuse need to be replaced, ensure that any replacement is of the same amperage and approved with the BSI mark.
- The television should be connected to a main socket outlet with a protective earthing connection.
- Never try and replace the mains plug unless you have adequate qualifications and are legally authorised to do so. In the event that a replacement Mains cable is required, contact the manufacturer for a suitable replacement.
- Never use the television if it is damaged in any way.
- Always place the television on a flat level surface avoiding anywhere which may be subject to strong vibration.
- Ensure the television is not placed on top of the power cable as the weight of the television may damage the cable and cause a safety hazard.
- Never place mobile phones, speakers or any other device which may cause magnetic or radio interference with the television. If interference is apparent, move the device causing the interference, near the television.
- To disconnect the apparatus from the mains, please use the mains plug located on the underside/rear of the TV. The mains plug shall remain readily operable.

- Batteries (battery pack or batteries installed) shall not be exposed to excessive heat such as sunshine, fire or the like.
- Install the product at least 5cm from the wall for ventilation.
- Ensure that the power switch on the unit and the mains plug are always easily accessible.

WARNING: Excessive noise when using earphones and headphones can cause loss of hearing.

Maintenance

- To clean this unit, wipe with a soft, dry cloth. If the surfaces are extremely dirty, use a soft cloth dipped in a soap and water solution or a mild detergent solution.
- Never use alcohol, paint thinner or benzene to clean this unit.
- Before using a chemically treated cloth, read the instructions that came with the cloth carefully.

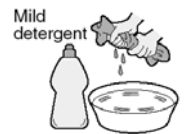

CAUTION: If water or other liquid enters the television through the display panel surface or back cover a malfunction may occur.

Packaging

- The safest way to transport your item is in the original box/packaging - please save your packaging for this.
- You will need original box/packaging in the event of warranty/service repair or support. We are unable to carry out warranty/service if you are unable to package the item correctly.

Important Safety Instructions

IMPORTANT - Please read these instructions. All the safety and operating instructions should be read before the appliance is operated.



Important Information - Regarding Use of Video Games, Computers, Captions or Other Fixed Image Displays

The extended use of fixed image program material can cause a permanent "shadow image" on the LCD/LED panel.

This background image is viewable on normal programs in the form of a stationary fixed image. This type of irreversible LCD/LED panel deterioration can be limited by observing the following steps:

1. Reduce the brightness/contrast setting to a minimum viewing level.
2. Do not display the fixed image for extended periods of time.
3. Turn the power off when not in actual use.

Examples of images that you need to watch out for are as follows (this is not an exhaustive list):

- TV Channel Logos: e.g. Shopping channel logos and pricing displays-especially if they are bright and stationary.
- Moving or low contrast graphics are less likely to cause ageing of the screen.
- Time Displays
- Teletext: Do not view a stationary page for a long period of time
- TV/DVD Menus: e.g. Listings of DVD disc content
- Pause Mode: Do not leave the TV in pause mode for long periods of time, e.g. When watching DVDs or videos.

Important - Once 'shadow image/screen burn' occurs, it will never disappear and is not repairable under warranty.

How do I dispose of this product?

UK: Waste electrical products should not be disposed of with household waste. Separate disposal facilities exist. For your nearest facilities, please see www.recycle-more.co.uk or in store for details.

ROI: Waste electrical products should not be disposed of with household waste. Separate disposal facilities exist. Check with your Local Authority or retailer for recycling advice.

Batteries

- Do not expose batteries to high temperatures, excessive heat, prolonged sunshine or fire as this may cause leakage, explosion or ignition.
- Observe the correct polarity when inserting batteries.
- Do not use different types of batteries together or mix old and new batteries.
- Dispose of batteries in an environmentally friendly way.
- Certain regions may regulate the disposal of batteries.



Cd

Please consult your local authority.



For DTS patents, see <http://patents.dts.com>. Manufactured under license from DTS Licensing Limited. DTS, the Symbol, & DTS and the Symbol together are registered trademarks, and DTS TruSurround is a trademark of DTS, Inc. © DTS, Inc. All Rights Reserved.

Contents

Manufacturers Guarantee Information	3
Important Safety Instructions	4-5
What is included in the box	9
Attaching the stand	10
Detaching the stand and securing the TV to a wall	11
Wall mounting	12
Getting Started - Initial Set Up	13
Remote Control	15
TV Buttons and Input Source Menu	16
Connections	17-19
TV Menu Operation	21-27
Channel Menu	21
Picture Menu	22-23
Sound Menu	24
Time Menu	25
Setup Menu	26
Lock Menu	27
Network Configuration	29
7 Day TV Guide and Channel List	30
USB Record Digital / Freeview	31
USB Mode / Media Player	32
General Information	33-37
Using your TV with a Sky digital set top box	33
Frequently Asked Questions	34-35
Technical Specifications	36-37

What Is Included In The Box

Accessories

Included with this TV are the following accessories:

1 x User Guide

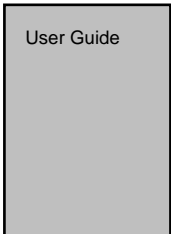

1 x Remote Control & 2 x AAA Batteries



1 x Quick Start Guide

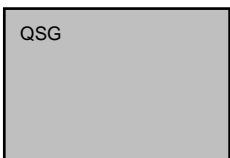

1 x Mini-AV cable



1 x TV



1 x SCART to Mini AV cable



1 x RF Cable



1 x Stand Installation Pack

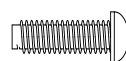

(A) 4 x M(4x16)

Used for attaching the stand neck to the TV

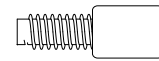

(B) 4 x M (4x(10+8))

Used for attaching the wire stand to the stand neck

Please save your packaging as you will need this in the event of warranty/service repair or support. We are unable to carry out warranty/service if you are unable to package it correctly. The safest way to package your item in the event of warranty/service repair is in its original box/packaging.

Attaching The Stand

To complete the stand installation you will require a cross head screw driver.

The Stand Installation pack comes with two different types of screws.

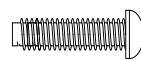

(A) 4 x M(4x16)

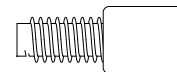

(B) 4 x M (4x(10+8))

fig 1) Attach the stand neck to the rear of the TV set.

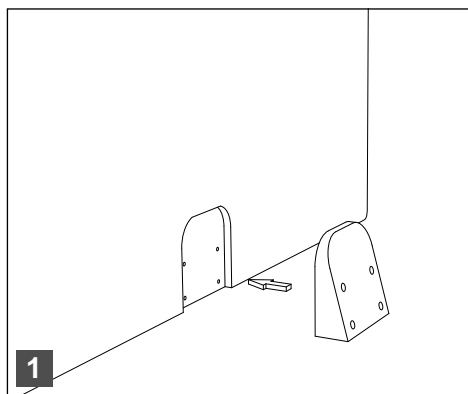

fig 2) Secure the neck to the TV using the (A) 4 x M (4x16) screws provided.

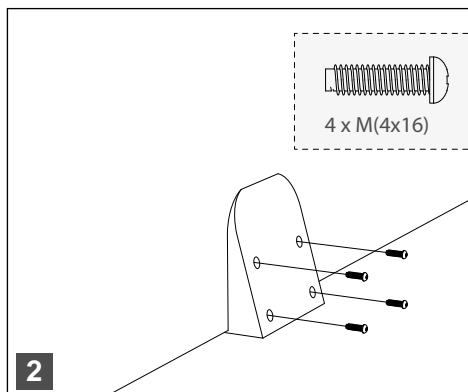

fig 3) Attach the wire base to the stand neck.

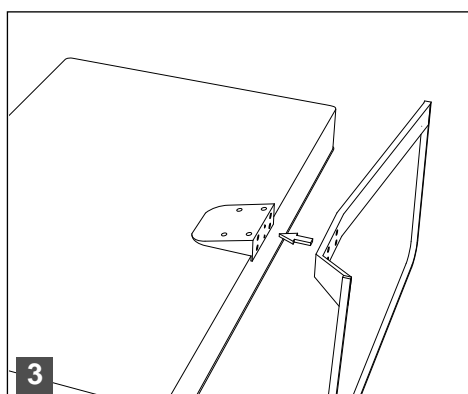
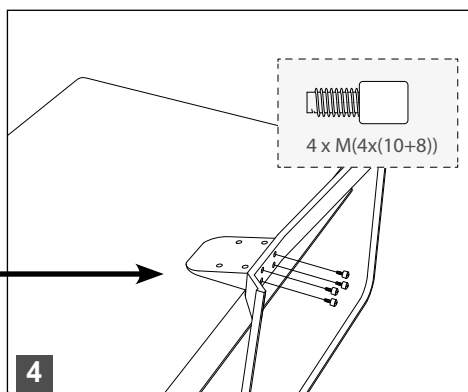

fig 4) Secure the wire stand to the neck using the (B) 4 x M (4x(10+8)) screws provided.



HELPFUL ADVICE FOR FIRST TIME STAND INSTALLATION

When securing the self-tapping screw/s into the base of the stand (on first installation) the screw/s will be naturally tight as they create a thread in the plastic of the stand neck in order to support a TV of this size.

a) Ensure the cross head screw driver tip fits correctly into the head of the screw and that it is not too big or small.

b) Screw in all screws individually and partially before tightening all of the screws fully.

c) If they become very tight try loosening them slightly and then re-tightening them once again as this will continue the process of creating the thread for the screws.

Detaching the stand and securing the TV to a wall

Detaching the Stand

To detach the stand please remove the **4** screws highlighted then remove the stand neck and base from the rear of the TV set.

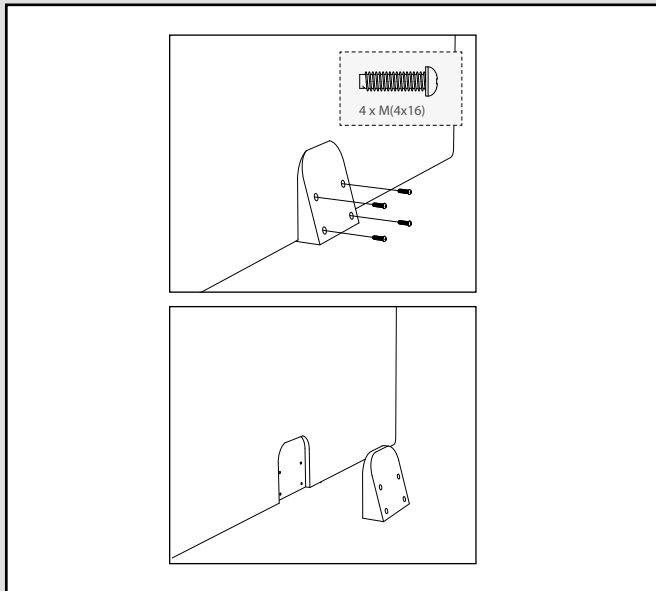

Securing the TV to a Wall

For maximum security in the home when using a TV with its stand anti-tip straps should be fitted. These are available from supermarket websites and other websites and are an easy, inexpensive and effective way of ensuring your TV stays safely upright. Straps are designed to be attached to the rear of the TV and then tethered to the wall of the furniture the TV is stood on.

Note - Please ensure that children do not climb on the TV set.

A) Using one or both of the top wall-mounting holes and screws (the screws are already supplied in the wall mounting holes) fasten one end of the fastening cord/s to the TV.

B) Secure the other end of the fastening cord/s to your wall. (you will need screws/fixings suitable for your wall type - available separately from most DIY stores)

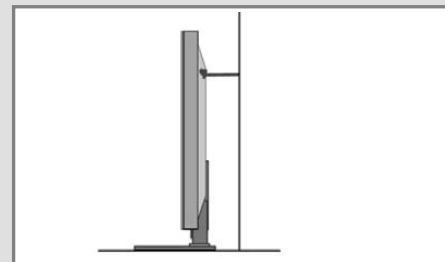
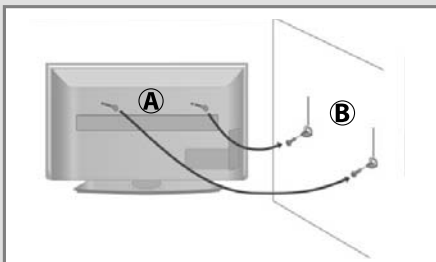

The Royal Society for the Prevention of Accidents is urging people to take care with flat-screen televisions.

RoSPA stated in 2010 that "Toddlers are particularly at risk of pulling flat-screen televisions on to themselves. They are unsteady on their feet and are attracted by colourful television images."

The risk is increased as televisions become lighter.

Wall Mounting

IMPORTANT - Before drilling any holes in the wall ensure you are not drilling where there could be any electric wires, water or gas pipes.

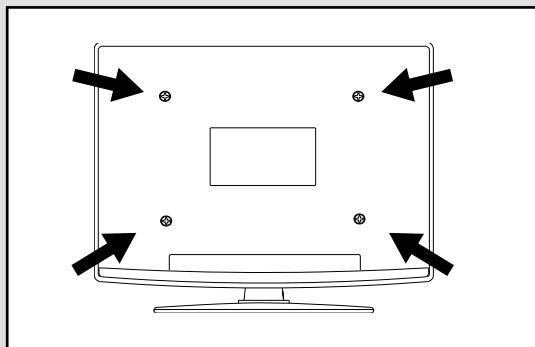

1) Remove the four screws highlighted below.

2) The wall mount can now be easily attached to the mounting holes on the rear of the TV. These holes are indicated in the picture below.

IMPORTANT – If wall mounting this TV, only use the screws already provided in the wall mounting holes. Using other screws which are longer could cause irreparable damage to internal parts.

For optimum viewing, if wall mounting the TV higher than eye level, the TV should be tilted downwards so that the TV's screen is 'face on'.

See **fig 1** and **2** below.

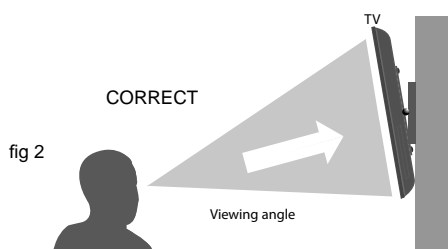
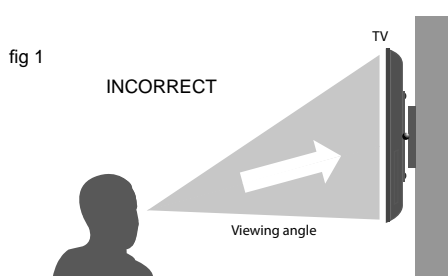

Getting Started - Initial Set Up

1) Using the RF cable supplied, connect the TV to the TV Aerial wall socket (Fig A).

Connect the power cable to the Electrical outlet (Fig B).

2) Switch on the television using the power on/off switch located on the side/underside of the TV.

3) Insert the batteries supplied into the Remote control and press the Standby button to power on the TV.

4) You will now be welcomed with the initial set-up screen. If it does not appear, on the remote control, please press [MENU] then 8-8-8-8 and the menu will appear. Press OK on the remote control and tuning will start.*

5) After tuning the following screen will appear.*

If you are missing channels, the reason for this is likely to be signal strength, you should consider connecting signal booster and re-tuning the TV.

* Screen shots/images are shown for illustration purposes only and may change dependent on model/region.

Important

As part of our ongoing development to reduce power consumption, we have added an extra function to this Television called 'Home Mode' (you will see this during the first time installation set up). Power consumption using the Home Mode function is approximately 25% lower than some other modes. The picture brightness is reduced using the Home Mode function. If this function is not suitable for your viewing environment, you can select other modes as necessary. (Please note, 'Store mode' is for optimum default picture settings, however, power consumption is approximately 25% higher than 'Home Mode').

Please refer to the user guide section 'Picture settings' in order to change the mode to one that maybe more suitable for your environment. There is also a shortcut button on the remote control called 'P-Mode' should you wish to change to another mode.

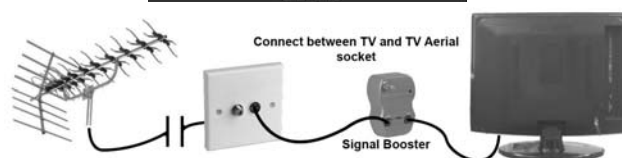
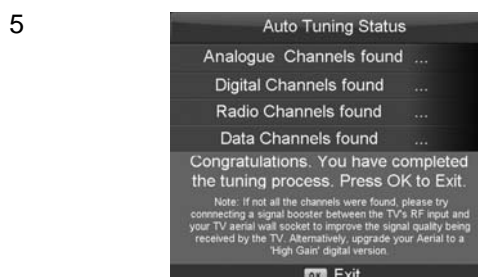
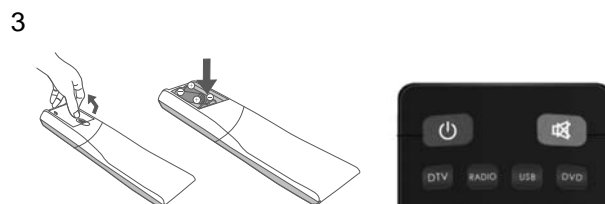

Remote Control

Viewing remote control - TV

1. STANDBY
2. MUTE
3. DTV
4. RADIO
5. DVD
6. USB
7. NUMBER BUTTONS
8. TV GUIDE
9. ↶ - To return to the previous channel viewed
10. P.MODE - Scrolls through picture mode options
11. VOL ▲/▼
12. CH ▲/▼
13. S.MODE - Scrolls through sound mode options
14. FAV - To display favourites menu
15. MENU
16. EXIT
17. (▲/▼/◀/▶/OK) - Allows you to navigate the on-screen menus and adjust the system settings to your preference
18. SOURCE/AV
19. INFO - Press once for now/next channel information. Press twice for programme information about current programme
20. ASPECT
21. SLEEP
22. SUBTITLE
23. AUDIO
24. TEXT
25. TEXT HOLD
26. DISPLAY
27. TEXTZOOM/DVD ZOOM
28. DVD Menu/Record
29. REC LIST
30. GOTO
31. A-B
32. REPEAT
33. ANGLE/
3D - Change to 3D mode

- Ⓞ For Models with Integrated DVD players
- ▶ For Models with PVR Function
- 📀 For Models with USB Playback
- ▲ For Models with 3D Feature

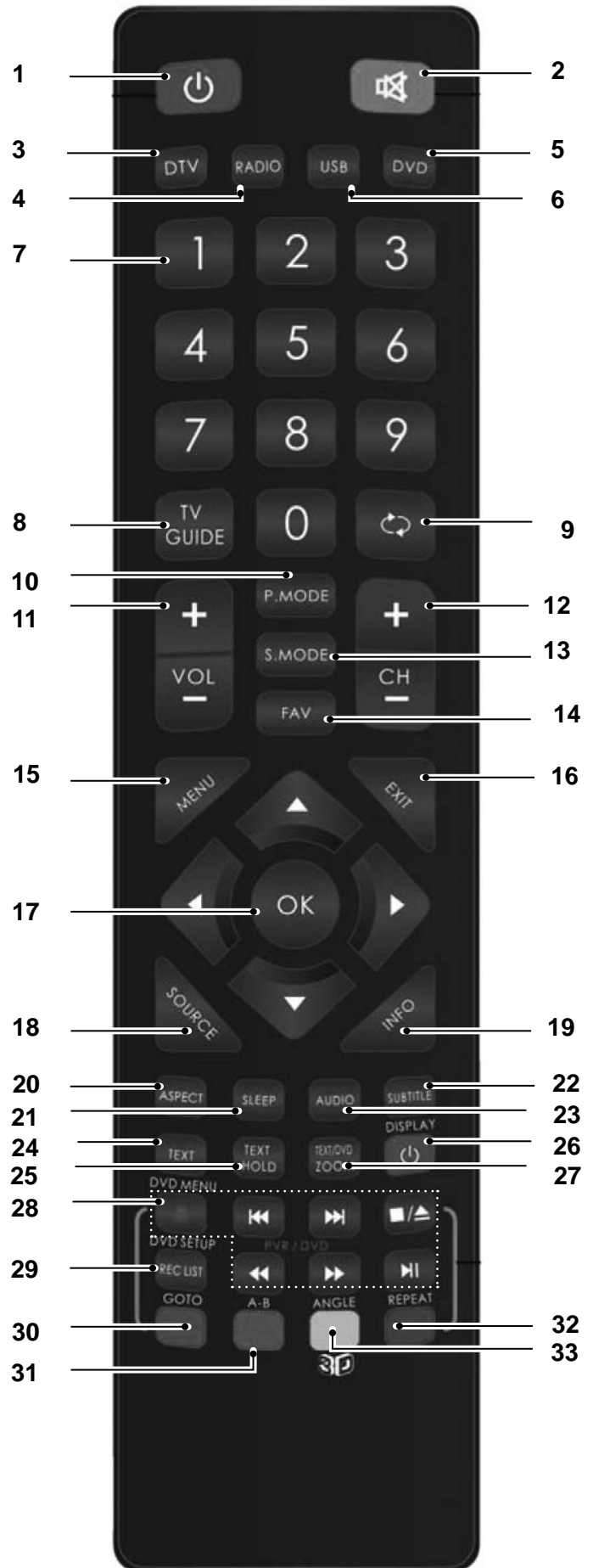

TV Buttons and Input Source Menu

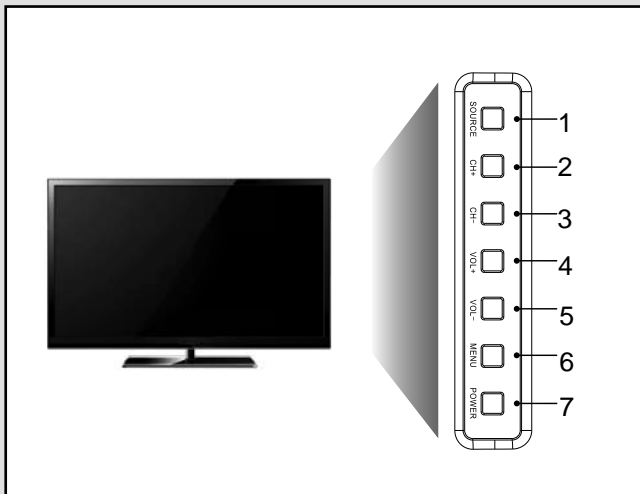

1. Displays the input source menu
2. Programme/Channel up and menu up
3. Programme/Channel down and menu down
4. Volume up and menu right
5. Volume down and menu left
6. Displays Menu/OSD
7. Standby Power On/Off

Choosing Mode Input/Source

To switch between the different input/connections.

A) Using the buttons on the remote control:

- 1) Press [SOURCE] - The source menu will appear.
- 2) Press [V] or [^] to select the input you require.
- 3) Press [OK].

B) Using the buttons on the Television:

- 1) Press [SOURCE].
- 2) Scroll up / down using CH+ / CH- buttons to the input/source you require.
- 3) Press Vol+ to change input/source to the one selected.

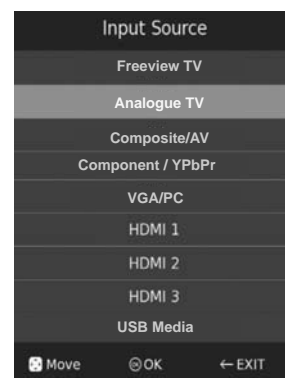

Example of Source menu depending on the TV model

Connections

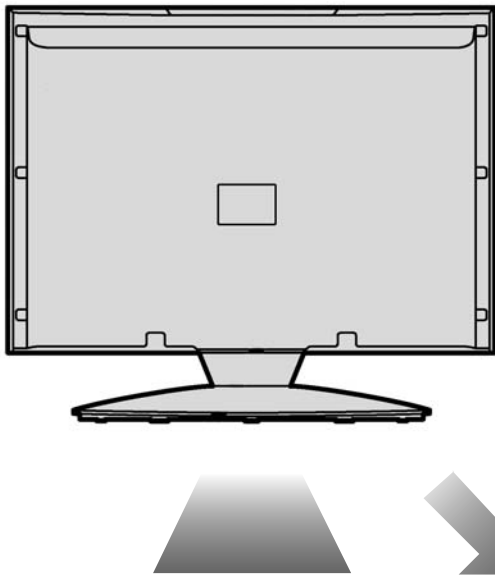

- | | | |
|----|-----------------|------------------------------|
| 1 | LAN | Network Connection |
| 2 | HDMI 1 | HDMI input |
| 3 | HDMI 2 | HDMI input |
| 4 | COMPONENT (HD) | Component input (YPbPr) |
| 5 | VGA PC Audio In | 3.5mm PC audio input |
| 6 | VGA PC | VGA-PC input |
| 7 | RF IN | RF / TV Aerial Input |
| 8 | HDMI 3 | HDMI input |
| 9 | CI CARD IN | Common Interface module |
| 10 | AV IN | Audio Video Input |
| 11 | USB | USB Input |
| 12 | EARPHONE | Earphone Socket |
| 13 | Digital Audio | Digital Optical Audio Output |

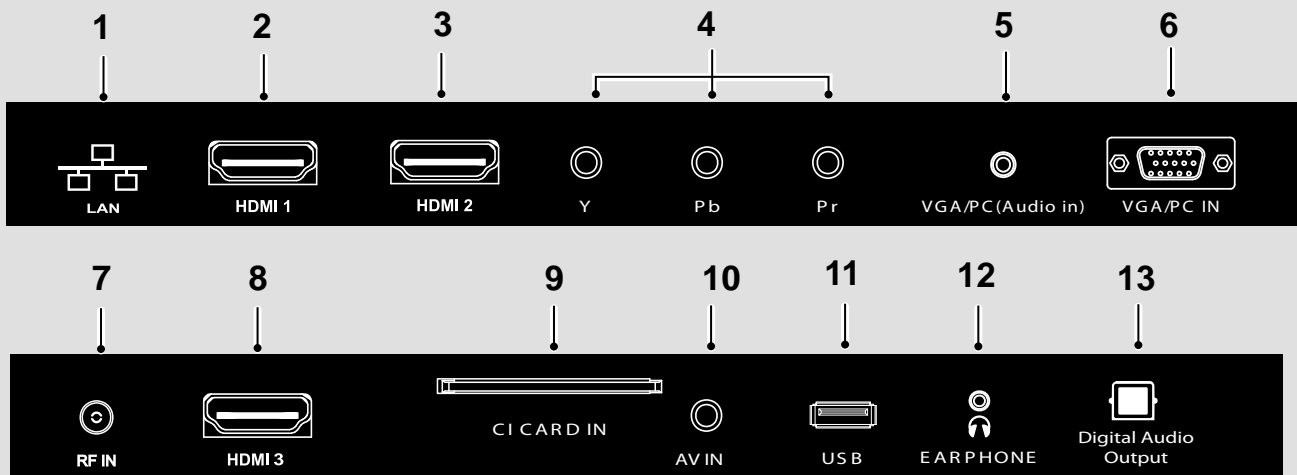

*The LAN/Ethernet port is used only for Freeview HD/Pay TV services. It is not intended to be used for internet/network use.

Connections

Note: Connecting cables are shown for example only and may not be included. Please check 'What Is Included In The Box' page.

Connecting a Camcorder, Camera or Games Console

Source should be set to Composite/AV

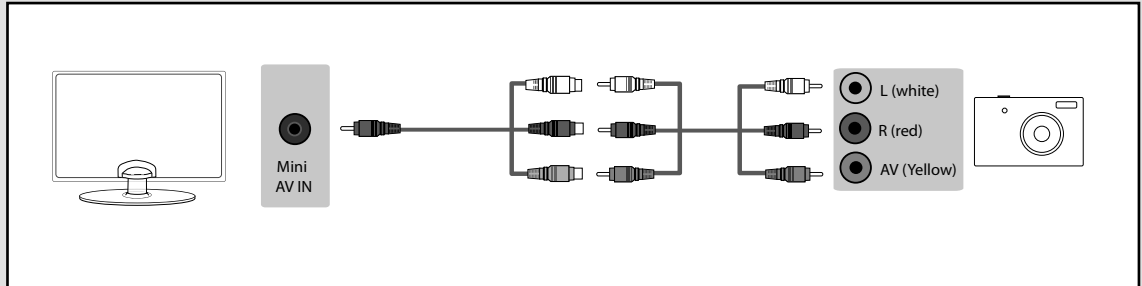

Connecting a DVD Player/Recorder, Video Recorder or Cable/Satellite Box

Source should be set to Composite/AV

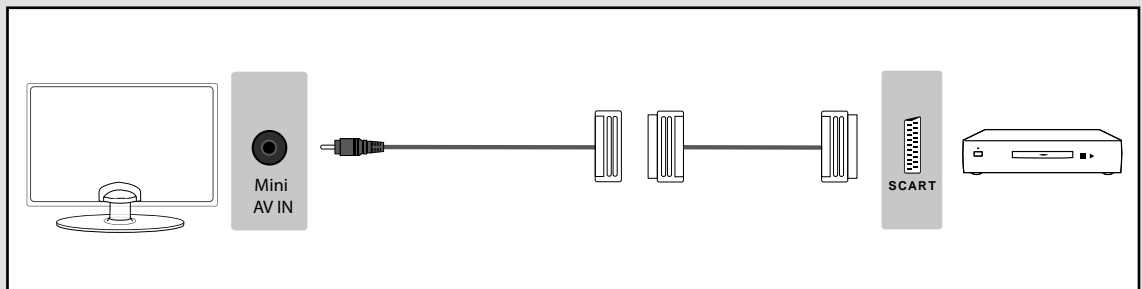

Connecting a High Definition (HD) Device Option 1 - via HDMI to HDMI cable

A HDMI cable can output both video and audio and enables you to enjoy digital-quality video and audio with minimal loss of quality.

Source should be set to the corresponding HDMI Port (HDMI 1, HDMI 2, etc)

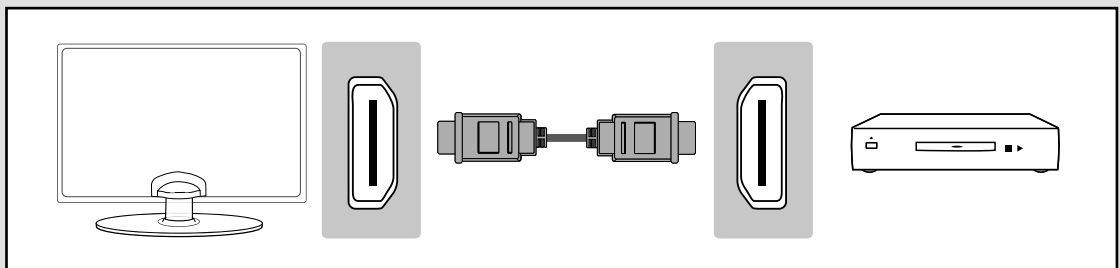

Note: This model TV can not be used as a PC/laptop monitor via HDMI input. The HDMI Input is provided to view digital content with compatible external devices..

Connections

Connecting a High Definition (HD) Device Option 2 - via Component cable

If you are supplied with a cable from the device which has RED, GREEN, BLUE, RED & WHITE connectors you must connect via Component (for picture) and by phono cable (for sound).

TV Source should be set to Component/YPbPr

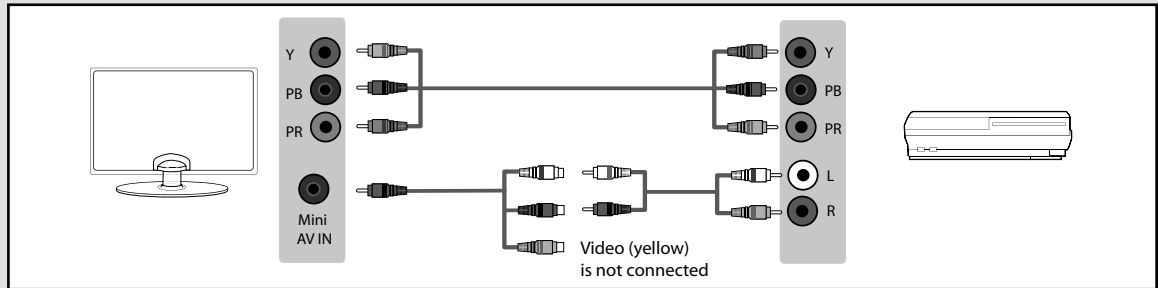

Connecting to a device with VGA/PC output (Laptop or Desktop Computer)

Source should be set to VGA/PC

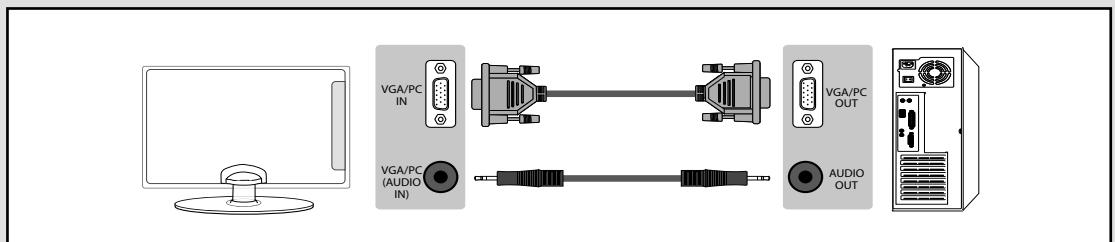

Connecting to an external audio device (Amplifiers, Surround Sound, Sound Bars etc)

When connecting via the TV's 3.5mm Earphone output, this will disable the TV speakers.

There are two options when connecting a device via the 3.5mm Earphone Output and the Digital Optical Audio Output

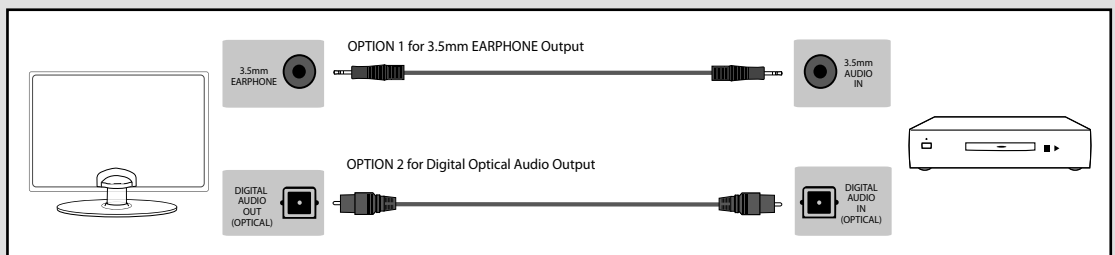

Connecting an Ethernet/Network cable

The Ethernet port is used only for Freeview HD/Pay TV services. It is not intended to be used for internet/network use.

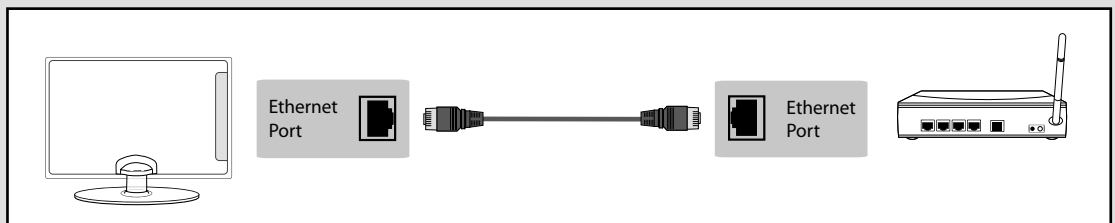

Channel Menu



Auto Tuning

Allows you to retune the television for all digital channels, digital radio stations and analogue channels.

Freeview Manual Tuning

Allows you to manually tune your digital signal

Analogue Manual Tuning

Allows you to manually tune your analogue signal

Channel Edit

Allows you to delete, move, skip and add favourite channels.

Signal Information

Displays signal strength information

CI Information

Pay per view services require a "smartcard" to be inserted into the TV. If you subscribe to a pay per view service the provider will issue you with a 'CAM' and a "smartcard". The CAM can then be inserted into the COMMON INTERFACE PORT (CI Card In).

Schedule List

Lists your programme reminders

Software Update (OAD)

Switch on/off OAD updates

Tip: If you do not press any buttons for 30 seconds, the menu will automatically exit. You can change the length of time before the menu exits automatically - see 'OSD Timer' in the Time Menu.



To access this menu, press [MENU] button on the remote control. To enter a menu press [OK]

If you wish to make changes to any of the default settings, use the scroll ▲▼▶◀ buttons. To confirm any settings press [OK] button.

To exit this menu at anytime, press [EXIT] button.



Important:

To receive Freeview channels, in particular Freeview HD channels, you will need a Digital TV aerial and be in a good Freeview coverage area. You can check coverage for your postcode at www.freeview.co.uk

Please note that any Freeview HD channels found during tuning will be placed in channel positions above 100. For example, 101 (BBC1 HD) 102 (BBC2 HD) etc.

Picture Menu

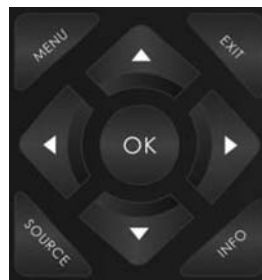

To access this menu, press [MENU] button on the remote control and scroll right.

To enter a menu press [OK]

If you wish to make changes to any of the default settings, use the scroll ▲▼▶◀ buttons. To confirm any settings press [OK] button.

To exit this menu at anytime, press [EXIT] button.

Picture Mode

- Dynamic - Recommended settings for fast moving pictures
- Standard - Default settings
- Mild - Set to be lighter in colour and less bright
- Personal - Lets you manually alter all the settings
- Economy - Power saving mode which reduces the energy used by up to 25% (by reducing the power to the LED/LCD panel). In Economy mode, the TV will switch itself to Standby mode after 3-5 hours in the event that the TV buttons or remote control buttons are not pressed (change the picture mode to another setting to de-activate this function)

Contrast

Switch the balance between black and white

Brightness

Increase or decrease the brightness of the picture

Colour

Increases the colour from black and white

Tint

Lets you increase or decrease the level of tint within the picture (only available in VGA/PC source mode).

Sharpness

Increase or decrease the sharpness of the picture

Colour Temperature

- Normal - Default settings
- Warm - Increases red within the picture
- Cool - Increases blue within the picture

Picture Menu



Aspect Ratio

Within the UK the picture format varies depending on the channel/broadcast. There are a number of different options to best meet your needs

- **Point2Point**
Automatically displays the best picture format. So the picture is in the correct position. May have black lines at the top/bottom and/or sides.
- **Original** - Will display the picture from the broadcaster without any change

Noise Reduction

- Off - Turns noise reduction off
- Low - Minor system adjustment
- Middle - Medium system adjustments
- High - Maximum system adjustments

Screen

Allows you to adjust screen settings when TV is used a PC monitor and the TV is set to the VGA/PC source.

- **4:3** - Displays the 4:3 picture in its original size. Side bars are shown to fill the 16:9 screen

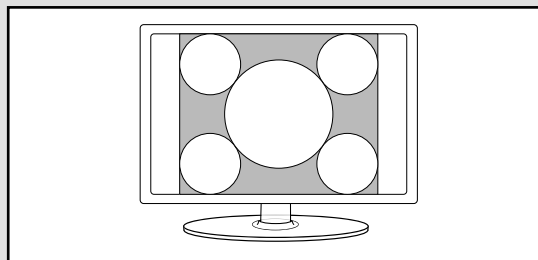

- **16:9** - Fills the screen with a regular 16:9 signal and 4:3 will stretch to fill the screen

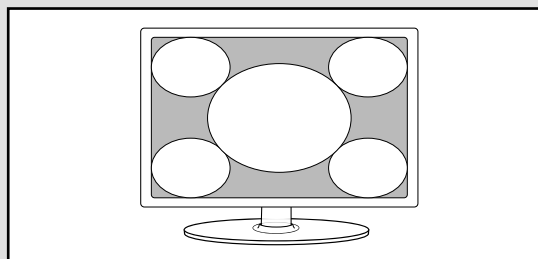

- **14:9** - Displays the 14:9 picture in the correct proportion. As a result side bars are shown on the screen

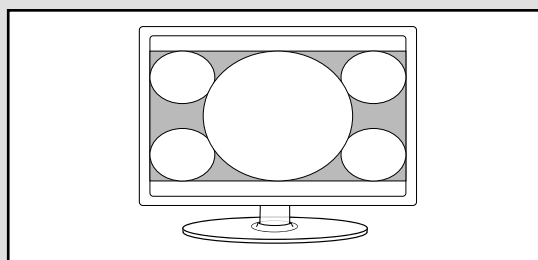

- **Zoom1 and Zoom 2** - The picture is the correct proportion but zoomed in to fill the screen

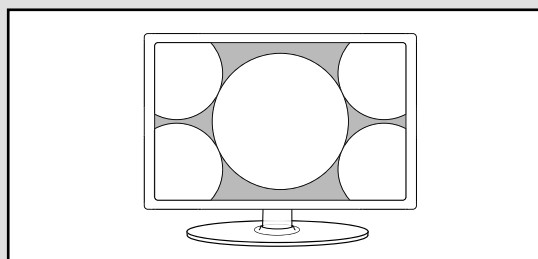

Sound Menu



Sound Mode

- Standard - Default settings
- Music - Emphasises music over voices
- Movie - Provides live and full sound for movies
- Sports - Emphasises sound for sports
- Personal - Selects your personal sound settings

Balance

To switch the sound between the left and right speakers

Auto Volume Level (AVL)

When 'on' is selected, the volume will stay at a constant level regardless of input/source

Surround Sound

- Off - Off
- TruSurround HD - TruSurround HD™ creates an immersive, feature-rich surround sound experience from two speakers, complete with rich bass, high frequency detail and clear dialog

Audio Description

This allows the user to increase and decrease the AD (Audio Description) volume level.

(Audio Description is a service available on certain programmes. It provides a description of what is happening during the selected programme for a person who is visually impaired)

Digital Output

- Off - Off
- Auto - Selects the best settings automatically
- PCM - Select this option if you are connecting to a Stereo Hi-fi via coax cable (Pulse-code modulation (PCM) is a digital representation of an analogue signal)

Audio Delay

Enables the user to adjust setting to sync picture and audio

Tip: Treble and bass levels can only be adjusted when the sound mode 'Personal' is selected.



For DTS patents, see <http://patents.dts.com>. Manufactured under license from DTS Licensing Limited. DTS, the Symbol, & DTS and the Symbol together are registered trademarks, and DTS TruSurround is a trademark of DTS, Inc. © DTS, Inc. All Rights Reserved.

Time Menu



Clock

Shows the date and time

Time Zone

Change your current time zone

Sleep Timer

Lets you set the sleep timer so the television automatically switches off after a set amount of time.
Off -> 10min -> 20min -> 30min -> 60min -> 90min -> 120min -> 180min -> 240min

OSD Timer

Lets you adjust the amount of time the On Screen Menu stays on the screen before disappearing

Auto standby

Set Auto standby between 3 hours, 4 hours and 5 hours (to turn off this function you must exit Home Mode in the Picture Menu)

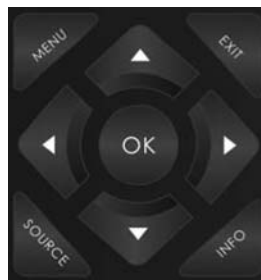

To access this menu, press [MENU] button on the remote control and scroll right.
To enter a menu press [OK]

If you wish to make changes to any of the default settings, use the scroll ▲▼▶◀ buttons. To confirm any settings press [OK] button.

To exit this menu at anytime, press [EXIT] button.

Setup Menu

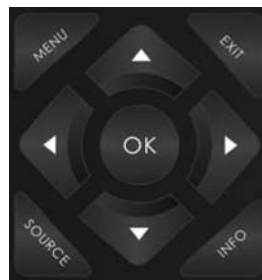

Language

Allows you to change the language of the menu

Audio language

Allows the user to change the audio language

Subtitle Language

Allows the user to change the subtitle language

Hearing Impaired

This allows the user to turn on the Hearing Impaired function, this produces subtitles on the screen which provide a description of what is happening during the selected program.

PVR File System

Allows you to view the format and performance of a USB key

Blue Screen

Changes the background when there is no input between clear and a blue background (Only available on some sources)

Network Configuration

Allows you to manually set your network settings on the TV (for more information please see 'Network Configuration' page)

First Time Installation

Allows you to retune the television for all digital channels, digital radio stations and analogue channels

HDMI CEC (Consumer Electronic Control)

Allows HDMI devices to control each other and allows the user to operate multiple devices with one remote control. (only available with compatible devices)

Software Update (USB)

This menu lets you install the new software/firmware onto the television. Further details of how to do this will be issued with the firmware. Contact the helpline or refer to the 'product support' section of the website

Reset TV

This resets the menus to factory settings and will erase all TV channels stored on the television

Lock Menu

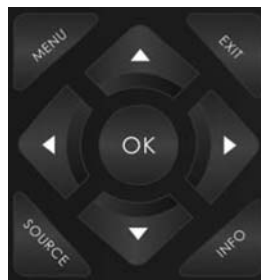
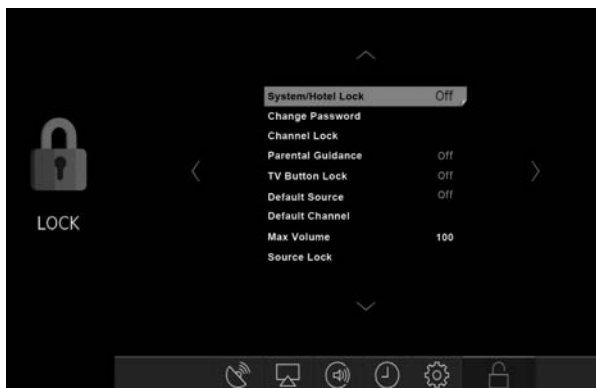

System/Hotel Lock

Allows you to lock or unlock the menu. You will be asked to enter a 4 digit password use the ◀ button to quit the password input. Use the ▶ button to clear. Default password is 0000

Change Password

Allows you to change the password

Channel Lock

Allows you to lock certain channels manually

Parental Guidance

Allows you to set the rating to block certain content based on age information

TV Button Lock

Allows you to lock the buttons on the side of the TV set

Default Source

Allows the user to set the default source. The default source is the source the TV starts on when first switched on

Default Channel

Allows the user to set a channel as the default channel on the Digital source. The default channel is the channel the TV starts on when first switched on

Max Volume

Allows you to adjust and set the maximum volume

Source Lock

Allows you to lock the source menu

Network Configuration

For the network configuration to work the TV will need to be connected to your home network via an Ethernet cable, with these requirements in place the TV will connect to the network automatically.

If you are looking to change the configuration to a static IP address this can be done by following the instructions below.

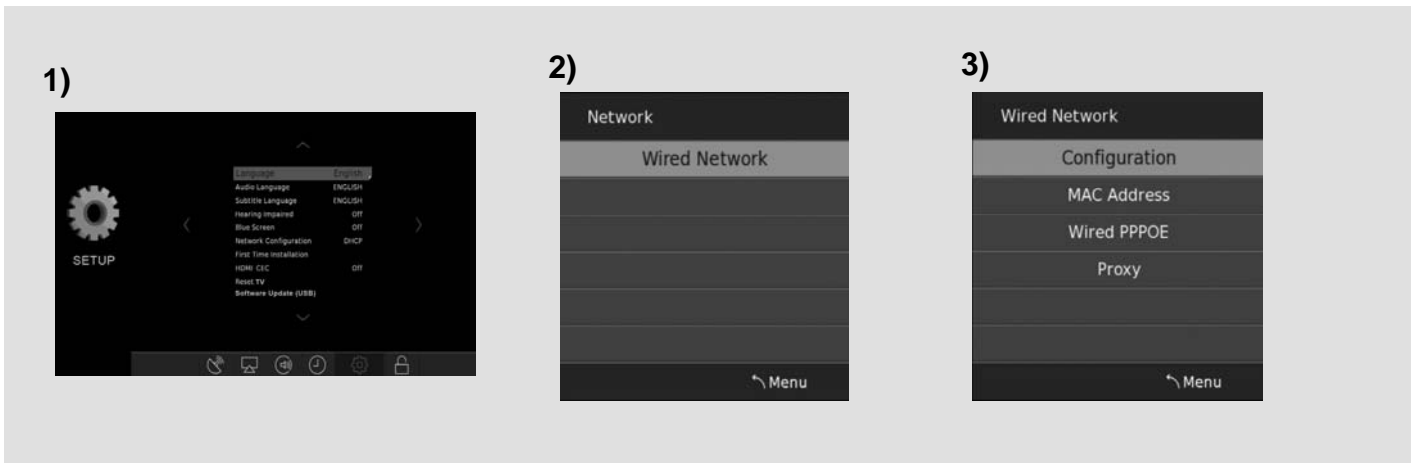

- 1) In the Setup Menu you will need to highlight and select Network Configuration.
- 2) When the Network menu appears highlight and select Wired Network.
- 3) Next the Wired Network menu will appear please highlight and select Configuration.

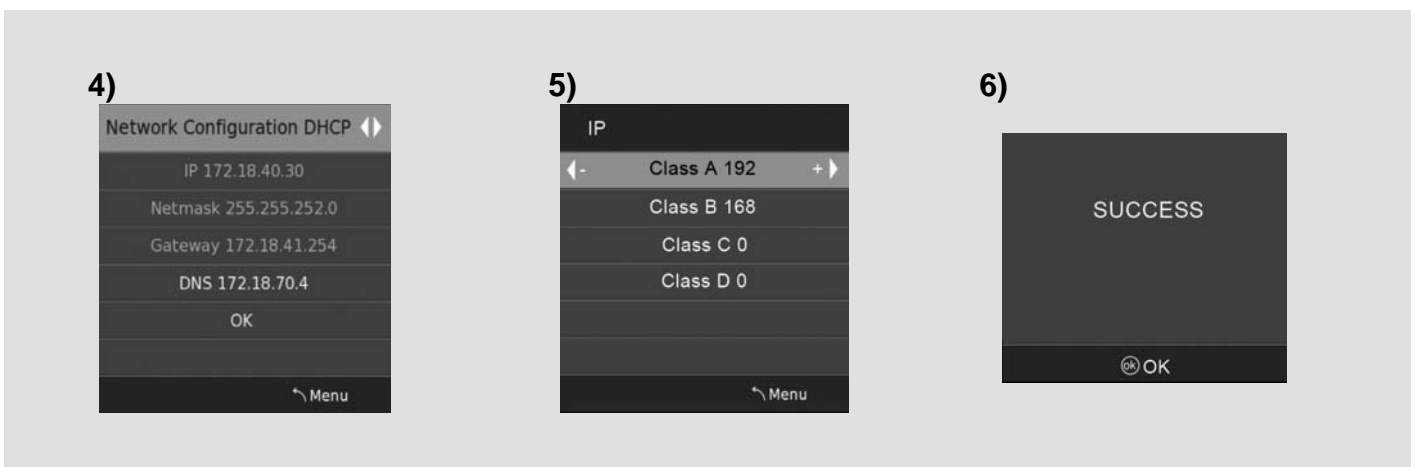

- 4) The Network Configuration menu allows you to choose between DHCP and Static. DHCP - will automatically connect the TV to your home network (this is the default setting and is highly recommended)
Static - is an advanced option and allows you to manually change the IP, Netmask, Gateway and DNS information.
- 5) If the static option is chosen you will be able to scroll down and manually change the IP, Netmask, Gateway and DNS information.
- 6) When the connection process is completed with either DHCP or Static option the Success screen will appear.

7 Day TV Guide and Channel List

TV Guide is available in Digital TV mode. It provides information about forthcoming programmes (where supported by the freeview channel). You can view the start and end time of all programmes and on all channels for the next 7 days and set reminders.

1) Press [TV GUIDE]. The following 7 Day TV Guide will appear.

2) Navigate through the menu using ▲▼▶◀

You can now:

Record a programme by pressing RED (USB device must be connected)

View a previous day by pressing GREEN

View the next day by pressing YELLOW

Set a reminder by pressing BLUE

3) Press [EXIT] to exit the 7 day TV Guide.

Channel List

To view the channel list, please ensure that the TV is set to either the analogue or digital source and no menus or TV notifications are displayed.

1) Press [OK] on the remote control and the channel list menu will appear.

2) Scroll through the channel list by using ▲▼ buttons then press [OK] to view the channel that is currently highlighted.

You can also:

View Freeview HD channels by pressing RED

View standard definition Freeview channels by pressing GREEN

View radio channels by pressing YELLOW

View all channels by pressing BLUE

3) Press [EXIT] to exit the channel list.

USB Record - Digital / Freeview Mode

USB Record – Digital/Freeview Mode

Built into this television is a USB record facility. This function is available in Digital/Freeview mode when used in conjunction with a compatible USB memory stick or USB hard drive. The benefits of this are as follows:

- Pause live TV and then playback, fast forward and rewind (up to live TV)
- One button record, if you decide you want to record the current programme
- Easy programmable recording from the 7 day TV Guide
- Record TV and watch/listen back on your computer/laptop

Due to the nature of the product, it is necessary to use a high speed USB memory stick (as the TV reads from and writes to the memory stick at the same time, some memory sticks may not be suitable)

You can purchase high speed memory sticks from some computer stores, alternatively, we have a selection of tested and compatible memory sticks available to purchase directly from the helpline/web site.

Minimum Specification - USB Memory Stick	Read Speed	20 MB/s (Mega Byte Per Second)
	Write Speed	6 MB/s (Mega Byte Per Second)

If you wish to use a USB portable hard drive larger than 32GB, please refer to the FAQ section at the rear of this user guide.

Pause Live TV (Time Shift)

Pausing Live TV is very simple.



 - Press the play/pause button and the television will pause and the live content will be recorded. To resume watching press play/pause again.

 - Press fast forward to go forward in a recording (i.e. to skip adverts)

 - Press fast rewind to go back in a recording (i.e. if you fast forwarded too far)

Tip: When you switch the TV to standby or change channel the Time Shift memory is wiped. To restart time shift you must press play/pause button.

One Button Record

At any point in time you may decide to record the current channel that you are watching. To do this you need to press the red button highlighted below.



Tip: This television contains one TV tuner, therefore it can only record the channel you are watching or record one channel while the television is in standby mode.

Note: USB record function is only available in Digital/Freeview TV mode. Due to copyright laws and illegal copying/recording it is not possible to record to/from any other input/output source.

USB Mode / Media Player

USB mode offers playback of various different types of content that you have saved on your USB Memory Stick.

On switching to USB source the menu screen will appear. The content will be divided into Photo, Music, Movie and Text based on file type.

1) You can navigate through the menus using the scroll ▲▼▶◀ buttons. To confirm the item you wish to play/view press [OK] button.

2) Select the drive you require.
(If your drive only has 1 partition you will only see 1 item).

3) You can now access the item. Press OK to view.

4) While viewing you control the item using (Fig A) or by pressing (i) and using ▲▼▶◀ and (OK)

Tips:

- If you experience a playback issue, please ensure the files being used are the correct format (example - the picture plays but no sound).
- For best performance, do not use USB extension cable.

See technical specification page for compatible file types.

1)

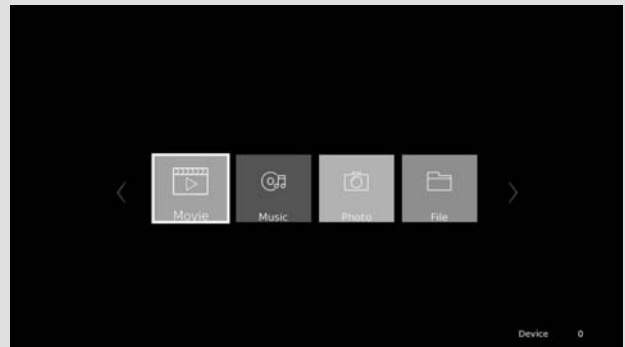

2)

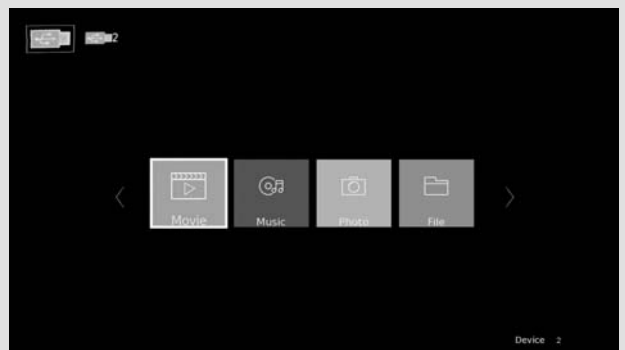

3)



4)



Fig A



Using Your TV With a Sky Digital Set Top Box

Option 1) Connecting your TV to your Sky box (when both the TV and Sky Box are located in the same room)

Depending on your Sky Box & TV model, connect either by SCART or HDMI cables (available separately).

If connecting by SCART, select the 'Input source' on the TV as Composite/AV.

If connecting by HDMI, select the 'Input source' on the TV as HDMI (if the TV has more than 1 HDMI port, ensure you select the input source to match the HDMI numbered port on the rear of the TV).

If you wish to use your Sky remote to operate the TV's functions, you will need a Sky remote control (Revision 9 or later) and you will need to programme a 4 digit code into it. See bottom of this page.

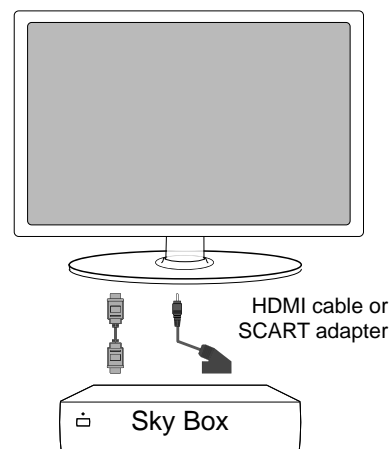

Option 2) Connecting your TV to your Sky box (when your Sky box is located in a different room to the TV)

Please note, if you are adding a 'Magic Eye/TV Link' to your system so that you can use your Sky remote control to change the Sky channel in the room where the 2nd TV is located, please refer to the instructions included with the TV link/magic eye in order to ensure the RF or RF2 output on your Sky box is powered on. (The red LED light on the TV link/magic eye will light up if the RF / RF2 output is correctly set up) If you do not have the instructions that came with the TV link/magic eye, instructions on how to do it can be found on our web site.

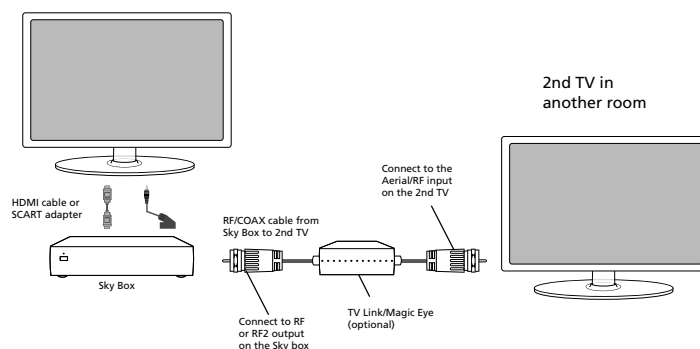

- 1) To tune the TV to the Sky box, on the 2nd TV, select the 'Analogue' input source.
- 2) Select the channel that you wish to store the Sky box/channel on. (If you do not use channels 1-5 because you no longer have analogue terrestrial channels after digital switchover, you may choose to select channel 1 to store the Sky box/channel, if you still have and use analogue channels 1-5, you may for example decide that channel 6 is the best option for you)
- 3) Press the corresponding number on the remote control to select the desired analogue channel chosen as per point 2 above.
- 4) On the TV remote control, press Menu. Now navigate through the menus to select Manual Tuning or Analogue Manual tuning (refer to the Tuning/Channel menu section of this user guide if necessary)
- 5) Manually tune in the channel (usually, the Sky box is at a frequency between 800Mhz and 850Mhz) once the Sky box/channel is found, press 'OK' to store it.

If you wish to use your Sky remote to operate the TV's functions, you will need a Sky remote control (**Revision 9 or later**) and you will need to programme a 4 digit code into it. **Please see below.**

Using a Sky Remote or a Universal Remote to operate your TV - Sky Remote Control, If you wish to use your Sky remote to operate the basic functions of your TV, you need to programme a 4 digit code into it. Please note. you will need the latest Sky Revision 9 remote control as this is the only version that includes the latest software/firmware necessary to operate this model of TV. **The code required for this television is 2134.** If you wish to upgrade/replace your existing Sky remote control to the latest version, you can do so on our web site.

Universal Remote Control, If you wish to use a Universal remote control to operate your TV, please refer to the web site for a full list of codes. (Please note we only have codes for One for All branded remote controls, if you have an alternative brand of Universal remote, please refer to the manufacturer for the code.)

Frequently Asked Questions

General	I would like to have louder sound by connecting additional speakers.	<p>1) Use the 3.5mm headphone output and a 3.5mm to phono cable (available separately) to connect to an amplifier/surround sound system. Please note this will deactivate the TV's built in speakers.</p> <p>2) Connect a Digital Optical Audio cable from the TV's Digital Optical Audio output to your amplifier/surround systems Digital Optical Audio input.</p>
General	Why are some options in the menu unavailable and greyed out.	Some options are only available in certain sources, i.e. HDMI, PC/VGA. They are unavailable in the other sources where they have no affect.
General	Can I stop my TV turning off after 4hrs?	Yes. In the time settings menu, scroll down to Auto standby and select OFF.
TV	I have tuned in Digital TV but I am not receiving any or all of the channels and/or the channels I receive are breaking up.	<p>1) Check you are in an area that can receive Freeview. Visit www.freeview.co.uk</p> <p>2) Check you are using an aerial that is able to receive a good digital signal. In most cases, you will need an outdoor digital hi-gain/wideband aerial. In areas that have excellent Freeview coverage, you may be able to use a loft type aerial but it is highly likely that you will also need to connect a booster between the back of the TV and the TV aerial wall socket. Unfortunately, to receive a good enough digital signal, it is not possible to use a portable/indoor type aerial. This may change once the analogue signal is switched off in 2012 and the Digital signal strength is increased.</p>
TV	I have re-tuned my television but when I switch it off it is not storing the channels.	Complete a first time installation, please refer to the set-up menu section of the manual of how to do this.
TV	I cannot find the Freeview HD channels	Freeview HD channels found during tuning will be placed in channel positions above 100. For example, 101 (BBC1 HD), 102 (BBC2 HD) etc.
VCR/DVD Recorder	I have connected the TV to my VCR or DVD Recorder via SCART but it is not recording.	In addition to connecting via SCART, you should connect the aerial cable from the wall socket to your VCR/DVD Recorder and another aerial cable from the VCR/DVD Recorder to the TV.
Game Consoles	I have connected my PS3 to the TV via HDMI, but I am not receiving any pictures or sound on my TV.	<p>1) Ensure the TVs source is on HDMI</p> <p>2) Check your settings on your PS3 are as per the PS3 instruction manual.</p>

Frequently Asked Questions

Game Consoles	I have connected my Xbox 360 to the TV via Component Cables (Red, Green & Blue) but I am not receiving any sound.	Component cables only provide HD Pictures. For the sound you will need to connect the Red & White audio cables on the Xbox to the Red & White phono inputs on the rear of the TV. Please refer to the 'Connections' pages.
USB Mode	I have inserted a USB Memory Key, but the TV does not recognise it.	Ensure the USB Memory Key is formatted to type FAT32.
USB Mode	Using a USB portable hard drive.	If you wish to use a portable hard drive larger than 32GB, please note that it must be formatted to the FAT32 file system in order to operate on this TV. Windows XP/Vista computers are only capable of formatting up to 32GB, therefore, you will need a software programme/utility to format larger hard drives. Please refer to the web site for more information.
USB Record / TV models only	I cannot change the channel, access the menu or use the red button	During Time Shift you cannot change the channel, access the menu or use the red button
USB Record / TV models only	When using the USB to record the picture 'breaks up' or experience loss of sound.	Check the USB Memory Stick meet the minimum requirements of Read Speed - 20 MB/s (Mega Byte Per Second), Write Speed - 6 MB/s (Mega Byte Per Second)
System Lock	I have changed the password on the television and now forgotten it.	There is a master password of 4711, to gain access to the TV menu and reset the normal password.
Freeview HD	I cannot access all Freeview channels	Some data channels for Freeview can only be obtained when the TV receives an internet connection.

Note:

Supplier may change TV software and on screen graphics without warning

Technical Specification

Product Fiche

Supplier	Bush
Model ID	50/238F
Energy efficiency class	A++
Visible screen size (diagonal)	127 cm / 50 inches
On mode model average power consumption	49 W
Annual energy consumption *1	72 kWh
Standby power consumption *2	<0.5 W
Off mode power consumption	0 W
Screen resolution	1920 (H) x 1080 (V)

*1: Energy consumption XYZ kWh per year, based on the power consumption of the television operating 4 hours per day for 365 days. The actual energy consumption will depend on how the television is used.

*2: When the TV is turned off with the remote control/standby button and no function is active.

Additional Technical Information

RF	75 ohm Antenna / Analog / DVB
Video Inputs	3 x HDMI, 1 x USB, 1 x Mini Composite/Video & L/R Audio shared for Composite/Video & Component/YPbPr, 1 x Component/YPbPr, 1 x VGA/PC
Sound Inputs	1 x 3.5mm jack for PC audio input
Sound Outputs	1 x Digital Optical Audio output , 1 x 3.5mm headphone jack
Speaker / Amplifier Watts (RMS)	2 x 10W / 2 x 8W
Dimensions including stand (mm)	1122W x 323H x 715D
Net weight	18.6kg
Energy Consumption Info	
Voltage and power consumption	110-240v 50 / 60Hz 49 / 70 / 90 W (ecomode/standard/max) EEL - A++ (Energy Rating)
Wallmounting VESA	300 x 200 (mm)

Technical Specification

Compatible files in USB Mode

Media	File Ext.	Video Decoder		Remark	
		Video	Audio		
Movie	.mpg/.mpeg .dat	MPEG-1, MPEG-2	MP3, WMA, AAC, LPCM, DTS(DMP), IMA-aDPCM/MS-A DPCM, LBR(cook), G711A/mu-law	Max Solution: 1920×1080 Max Data Rate: 40 Mbps	
	.ts/.trp/.tp/ .m2ts	MPEG-2, H.264, VC1, AVS			
	.vob	MPEG-2			
	.mp4	MPEG-4, Xvid, H.264			
	.rm/.rmvb	Rm codec			
	.mkv	MPEG-1, MPEG-2, MPEG-4, H.264			
	.avi	MPEG-2, MPEG-4, Xvid, H.264			
	Motion JPEG	JPEG			Max Solution: 640×480 Max Data Rate: 10 Mbps
	.asf, wmv	VC1			
.flv/.swf	H.264, AVC, Sorenson H.263		Max Solution: 1920×1080 Max Data Rate: 40 Mbps		
Music	.mp3	--	MPEG1/2 (Layer1, Layer2, Layer3)	Sample Rate: 16KHz-48KHz BitRate: 32K-448Kbps	
	.wma/.asf	--	WMA	BitRate: 128Kbps-320Kbps Sampling rate : 8KHz-48KHz	
			WMA pro	BitRate: <768Kbps Sampling rate : ~96KHz	
	.ogg	--	OGG	Sample Rate: ~48KHz	
	.m4a/.aac	--	AAC HEAAC	Sample Rate: 8K-48KHz Bit Rate: 24K-384Kbps	
Photo	.jpg/ .jpeg	Progressive JPEG		Max Resolution: 1024×768	
		Baseline JPEG		Max Resolution: 1920×8×1088×8	
	.bmp	BMP		Max Resolution: 9600×6400	
	.png	Non-Interlaced		Max Resolution: 9600×6400	
		Interlaced		Max Resolution: 1200×800	



BUS/MAN/0016