

AT2055/AT2056	Important safety instructions	3
	Disposal instructions	4
AT2355/AT2356	Your LCD TV overview	5
	Front panel view	5
	Rear panel view	6
User Guide	Remote control	7
	General keys	7
	Teletext	8
	Basic connections	9
	Connecting the power cord	9
	Setting up the remote control	9
	Enjoying analog and digital TV	10
	Connecting an antenna/cable	10
	Getting started watching your TV	10
	Connecting external audio/video devices	12
	Connecting a DVD, VCR, STB or audio/video equipment	12
	Connecting a camera, camcorder or video game	13
	Connecting a PC or notebook computer	14
	Selecting the input source	14
	OSD navigation	15
	Navigating the OSD with the remote control	15
	Adjusting the OSD settings	16
	Empowering Technology	18
	Set-up Empowering mode	18
	Default setting in different Empowering mode	19
	Advanced features	21
	Advanced Picture Adjustment	21
	Steady Sound	23
	Channel Edit	24
	Reorder for channels	26
	Channel scan ordering	28
	Intelligent Zapping	29
	Blue Mute	30
	Parental Control	31
	TV ratings (for digital TV mode)	33
	Channel list	35
	Electronic programme guide	36
	Sound effects	38
	Widescreen display mode	38
	Troubleshooting	40
	PC Input Signal Reference Chart	41
	Product specifications	43

Copyright © 2009 All Rights Reserved.

Acer LCD TV User Guide



Original Issue: 04/2009

Model Number: _____

Serial Number: _____

Purchase Date: _____

Place of Purchase: _____

	HDMI, the HDMI logo and High-Definition Multimedia Interface are trademarks or registered trademarks of HDMI Licensing LLC.
	DVB is a registered trademark of the DVB Project.

Important safety instructions

Read these instructions carefully. Please put them somewhere safe for future reference.

1. Only use attachments/accessories specified by the manufacturer.
2. Use only with the cart, stand, tripod, bracket, or table specified by the manufacturer, or sold with the apparatus. When a cart is used, use caution when moving the cart/ apparatus combination to avoid injury from tip-over.
3. Unplug this apparatus during lightning storms or when unused for long periods of time.
4. Do not install this equipment in a confined space such a book case or similar unit.
5. No naked flame sources, such as lighted candles, should be placed on the apparatus.
6. If the remote control will not to be used for a long time, remove the batteries. Use the remote control carefully. Do not drop the remote control on the floor. Keep it away from moisture, direct sunlight, and high temperatures.
7. Used or discharged batteries must be properly disposed of or recycled in compliance with all applicable laws. For detailed information, contact your local solid waste disposal authority.
8. Follow all warnings and instructions marked on the product.
9. Unplug this product from the wall outlet before cleaning. Do not use liquid cleaners or aerosol cleaners. Use a damp cloth for cleaning.
10. Do not use this product near water.
11. Do not place this product on an unstable cart, stand or table. The product may fall, sustaining serious damage.
12. Slots and openings are provided for ventilation; to ensure reliable operation of the product and to protect it from overheating, these openings must not be blocked or covered. The openings should never be blocked by placing the product on a bed, sofa, rug or other similar surface. This product should never be placed near or over a radiator or heat register or in a built-in installation unless proper ventilation is provided.
13. This product should be operated from the type of power indicated on the marking label. If you are not sure of the type of power available, consult your dealer or local power company.
14. Do not allow anything to rest on the power cord. Do not locate this product where the cord will be stepped on.
15. If an extension cord is used with this product, make sure that the total ampere rating of the equipment plugged into the extension cord does not exceed the extension cord ampere rating. Also, make sure that the total rating of all products plugged into the wall outlet does not exceed the fuse rating.
16. Never push objects of any kind into this product through cabinet slots as they may touch dangerous voltage points or short-out parts, which could result in a fire or electric shock. Never spill liquid of any kind on the product.
17. Do not attempt to service this product yourself, as opening or removing covers may expose you to dangerous voltage points or other risks. Refer all servicing to qualified service personnel.
18. Unplug this product from the wall outlet and refer servicing to qualified service personnel under the following conditions:



- a. When the power cord or plug is damaged or frayed.
 - b. If liquid has been spilled into the product.
 - c. If the product has been exposed to rain or water.
 - d. If the product does not operate normally when the operating instructions are followed. Adjust only those controls that are covered by the operating instructions. Improper adjustment of other controls could result in damage; extensive work by a qualified technician might then be required to restore the product to normal condition.
 - e. If the product has been dropped or the case has been damaged.
 - f. If the product exhibits a distinct change in performance, indicating a need for service.
- 19 Use only the proper type of power supply cord set (provided in your accessories box) for this unit. Always disconnect the power cord from the wall outlet before servicing or disassembling this equipment.
 - 20 Do not overload an electrical AC outlet, power strip, or convenience receptacle. The overall system load must not exceed 80% of the branch circuit rating. If power strips are used, the load should not exceed 80% of the power strip input rating.
 - 21 Some products are equipped with a three-wire electrical grounding-type plug that has a third pin for grounding. This plug only fits into a grounded electrical outlet. This is a safety feature. Make sure the AC outlet is properly grounded. Do not defeat the safety purpose of the grounding-type plug by trying to insert it into a non-grounded outlet. If you cannot insert the plug into the outlet, contact your electrician to replace the obsolete outlet.
 - 22 Do not use this LCD TV in the workplace according to BildscharbV, and maintain ample distance from it when watching. Watching a big-screen TV too close can cause eyestrain.
 - 23 This TV is designed for home entertainment purposes only. Make sure there is sufficient distance between you and the TV when you are viewing content to avoid harming your eyes.



The grounding pin is an important safety feature. It is possible to receive an electric shock from a system that is not properly grounded.



The grounding pin is also providing good immunity ability against unexpected noise that interferes performance of this product and is produced by other nearby electrical devices.

Disposal instructions

Do not throw this electronic device into the rubbish bin / container when discarding. To minimize pollution and ensure utmost protection of the global environment, please recycle.

For more information regarding WEEE, please refer to <http://global.acer.com/about/environmental.htm>



Соответствует сертификатам, обязательным в РФ
(Compliant with Russian regulatory certification)



ME61

Your LCD TV overview

Front panel view	
1	Common interface
2	AV in-S-video, CVBS, Audio L/R
3	Service port
4	Earphone*
5	HDMI

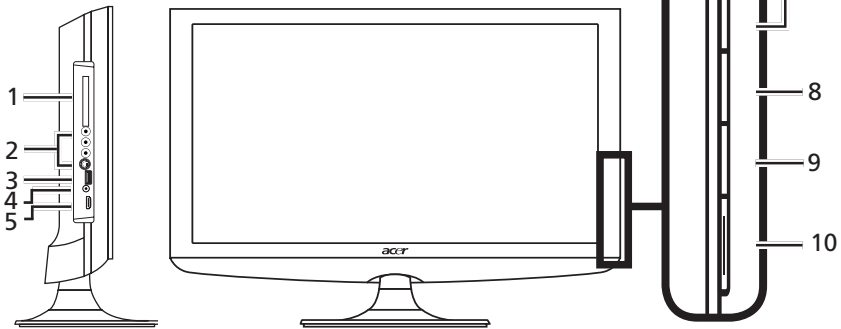

6		Volume up	When the OSD is on, functions the same as the Right arrow.
		Volume down	When the OSD is on, functions the same as the Left arrow.
7		Channel up	When the OSD is on, functions the same as the Up arrow.
		Channel down	When the OSD is on, functions the same as the Down arrow.
8		Menu key	Turns the OSD menu ON and OFF.
9		Input key	Press to change input source. When the OSD is on, press this button to confirm selection.
10		Power On/Off	Turns the power ON and OFF.



* Ensure you adjust the sound to a comfortable level when using earphones or headphones. If the volume is too loud, you risk permanent damage to your hearing.

Rear panel view

1	AC-in	2	VGA-in + PC Audio-in
3	Service port	4	HDMI
5	SPDIF out	6	AV in-COMPONENT + Audio L/R
7	SCART	8	Tuner*

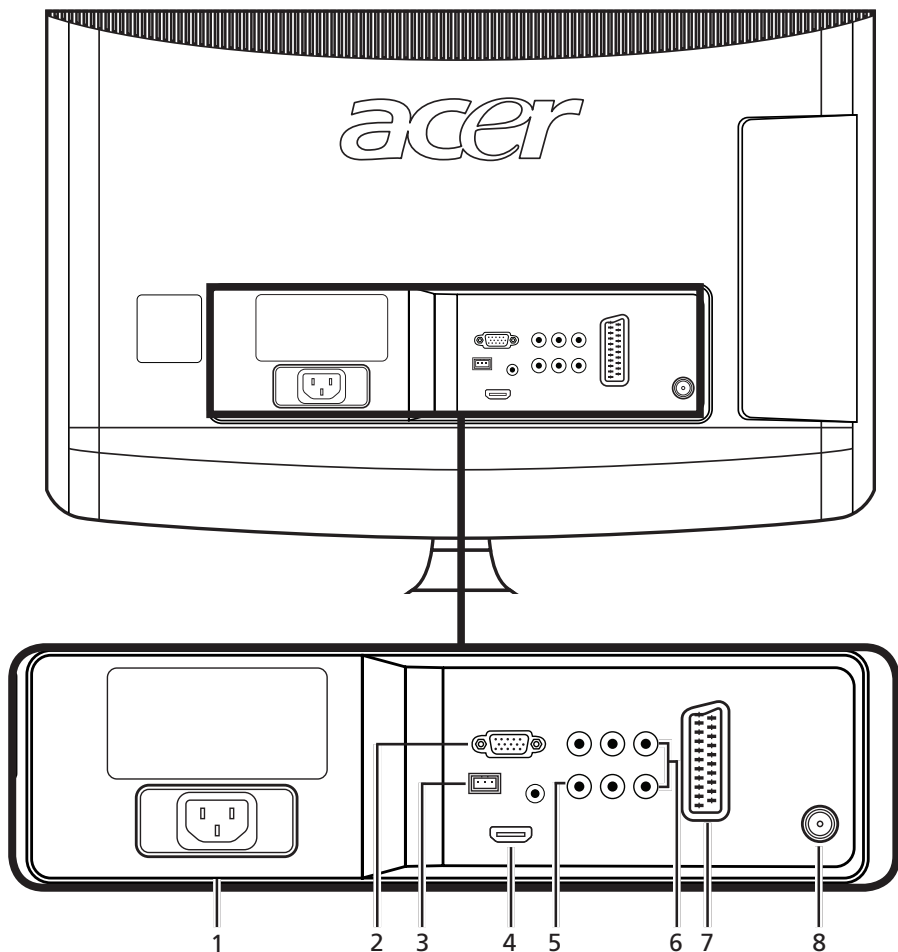

* Tuner could support analog, digital and mixed signal.

Remote control

General keys

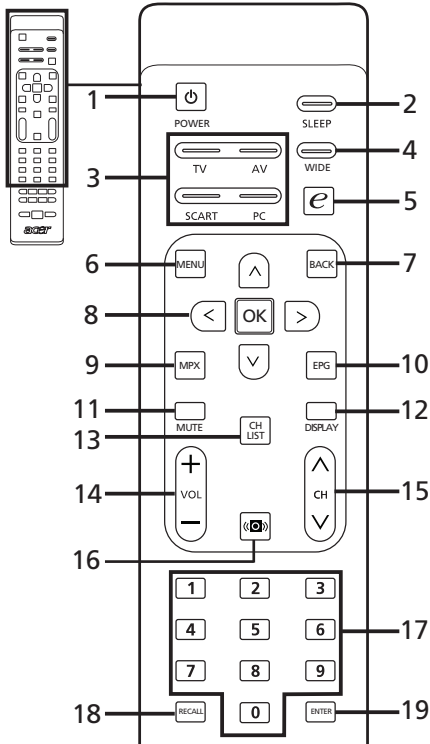

1 POWER

Press to turn your TV on/off.

2 SLEEP

Press to set a time period after which the TV will switch itself to standby (15, 30, 45, 60, 90 or 120 minutes).

3 Input buttons (TV/AV/SCART/PC)

Press to select correct input mode.

4 WIDE

Press to toggle scaling mode between Wide detect, 4:3, 16:9, Panorama and Letterbox 1, 2, 3 modes.

5 e (Empowering Technology)

Press to activate Acer Empowering Technology. See page 18.

6 MENU

Press to open or close the Menu.

7 Back

Press to back to previous Menu.

8 Directional keys/OK

9 MPX

Press to select the audio type, displayed in the top right-hand corner.

10 EPG

Press to launch Electronic Programme Guide (EPG) mode (Digital TV mode only). See page 34.

11 MUTE

Press to toggle audio on and off.

12 DISPLAY

Press to display or change input/channel information (dependent on input/source type).

13 CH LIST

Press to launch the channel list. See page 33.

14 VOL (+/-)

Press to increase or decrease the volume.

15 CH (up/down)

Press to sequentially select the TV channel.

16 Sound

Press to turn audio mode to virtual audio effect mode.

17 Number keys.

18 RECALL

Press to return to the previous channel. See page 29.

19 ENTER

Press to confirm channel number selection.

Teletext

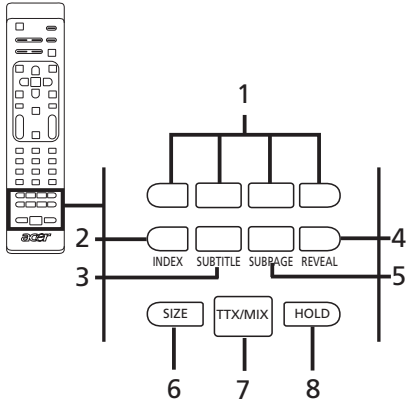

- 1 Colour buttons (R/G/Y/B)**
Operates corresponding button on the teletext page.
- 2 INDEX**
Press to go to the index page.
- 3 SUBTITLE**
Press to view subtitles on the screen.
- 4 REVEAL**
Press to reveal hidden teletext information.
- 5 SUBPAGE**
Press to access the teletext's subpages directly.
- 6 SIZE**
Press once to zoom teletext page to 2X.
Press again to resume.
- 7 TTX/MIX (TELETEXT/MIX)**
Press to switch from TV/AV to Teletext mode.
Press to overlay teletext page on the TV image.
- 8 HOLD**
Press to pause the current teletext page in multi-page viewing mode.
When watching TV, press to freeze the image on the screen.

Basic connections

Connecting the power cord

- 1 Connect the AC cord into the AC input on the back of the set.
- 2 Connect the plug to the wall outlet as shown.

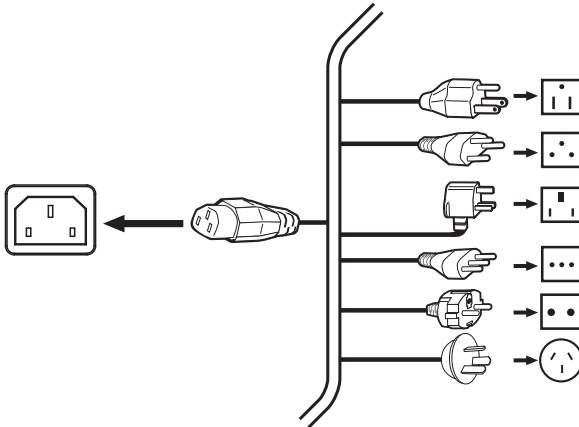

A certified power cord that meets your country's legal requirements must be used with this TV. You may also use an ordinary polyvinyl cord that meets IEC 60227 requirements or a synthetic rubber cord that meets IEC 60245 requirements.

Setting up the remote control

- 1 Open the cover on the back of the remote unit.
- 2 Insert two AAA batteries (supplied) to match the polarity indicated inside the battery compartment.

Enjoying analog and digital TV

Connecting an antenna/cable

Connect the antenna cable to the appropriate antenna terminal on the back of the TV set as shown below.

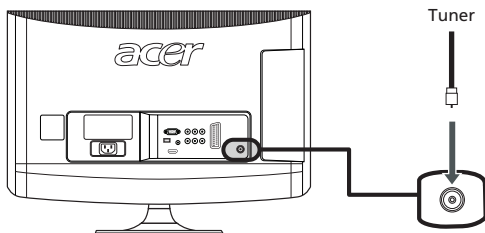

Getting started watching your TV

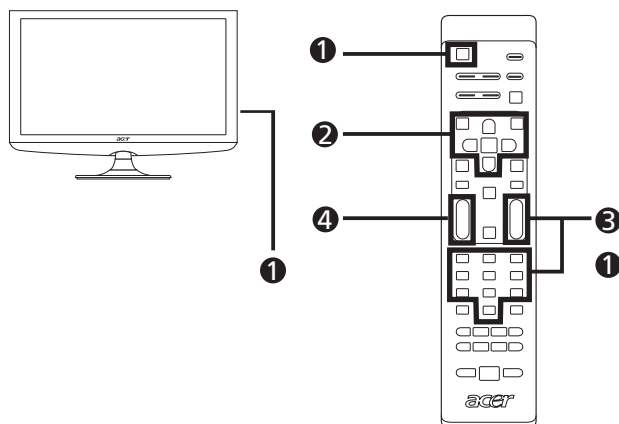

1 Power

- Turn on the power switch beneath the screen.
- Press the power button or channel up/down button on the remote control.

2 Setup Wizard

The first time you switch on the TV, the Setup Wizard will guide you to complete the language selection and channel scanning.

Press the OK key to begin the setup process.



You can also adjust these settings using the front control panel. Please see "Front panel view" on page 5 for details.

Step 1. Select the setup language you prefer.

Step 2. Please select country.

Step 3. Enter the correct time zone using the remote control.

Step 4. Ensure that your co-axial cables are connected correctly before proceeding.

Step 5. Scan for digital channels and analog channels.

Step 6. Setup is now complete. You are ready to begin watching TV.



If you leave the setup process before it is complete, you will be given a choice of options:

1. Resume setup
2. Resume setup wizard at next startup
3. Exit and do not remind me

Select an option and press OK to exit.

③ Changing channels

- a. Press 0 - 9 on the remote control to select a channel. The channel changes after 2 seconds. Press ENTER to select the channel immediately.
- b. Pressing the channel (CH) up / down button on the remote control will also change the channel.

④ Adjusting the volume

Adjust the volume level using the (VOL) up/down button on the remote control.



Setup may vary due to local broadcast differences.

Connecting external audio/video devices

Connecting a DVD, VCR, STB or audio/video equipment

Connect your DVD player, VCR or audio/video equipment using the SCART port located at the rear of your LCD TV as shown below.

Source-in

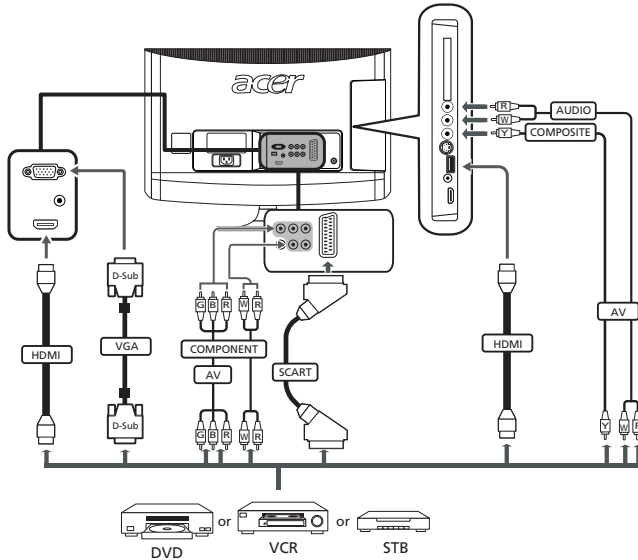

-  Yellow
-  Red
-  White
-  Blue
-  Green



* Acer recommends the following priority for connection types:
HDMI -> COMPONENT -> SCART -> S-Video -> Composite.

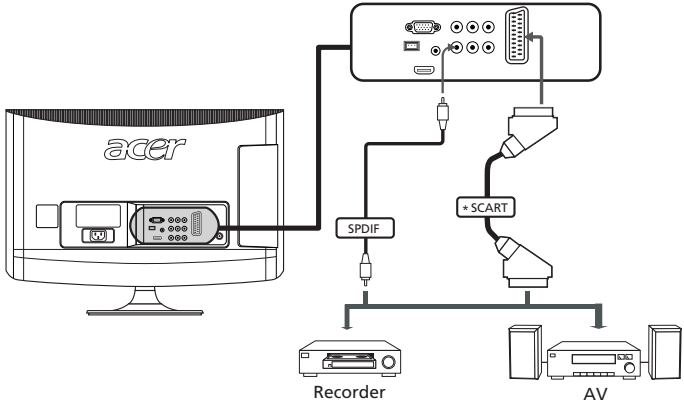

Connecting a camera, camcorder or video game

Connect your camera or camcorder to the video/audio ports on the left of the TV set as shown below.

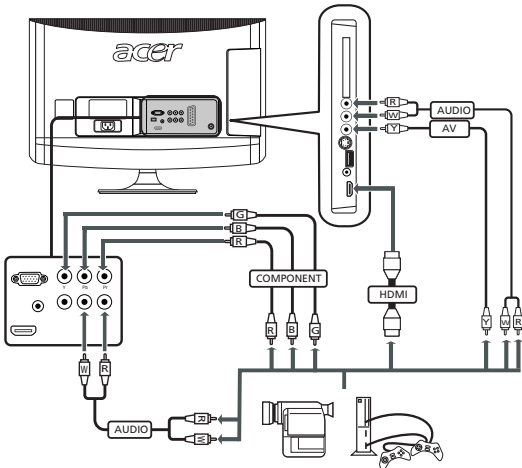

Connecting a PC or notebook computer

To display PC output on your TV, connect your PC or notebook computer to the TV as shown below.

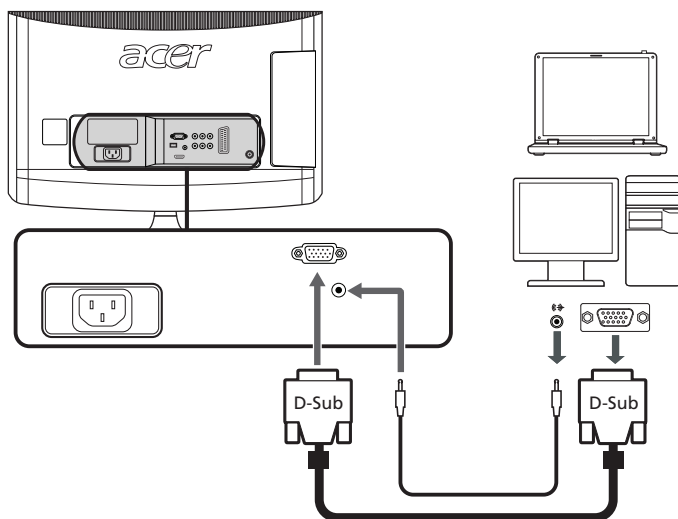

For VGA connections, Acer recommends setting your PC's external monitor resolution to 1600 x 900 pixels (AT2055/AT2056) or 1920 x 1080 (AT2355/AT2356)@ 60 Hz refresh rate.

Selecting the input source

Once you have connected your antenna or external equipment to the TV, you need to select the correct input source.

Press the corresponding button on the remote control to select the correct input source.

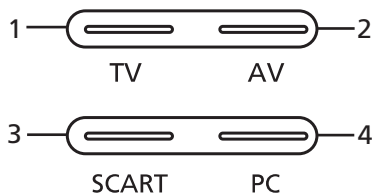

Input button guide:

- 1 **TV key**
Toggle TV (Analog TV and Digital TV) between input sources.
- 2 **AV key**
Toggle Composite, Component, HDMI1 and HDMI2 between input sources.
- 3 **SCART key**
Toggle SCART between input sources.
- 4 **PC key**
Toggle VGA between input sources.

OSD navigation

Many of the advanced settings and adjustments are available through using the OSD (onscreen display) menus, as shown in the example screenshot below.

Basic operations required to navigate these menus (Picture, Sound, Channel management, Settings and Advance) are described in this section.

Navigating the OSD with the remote control

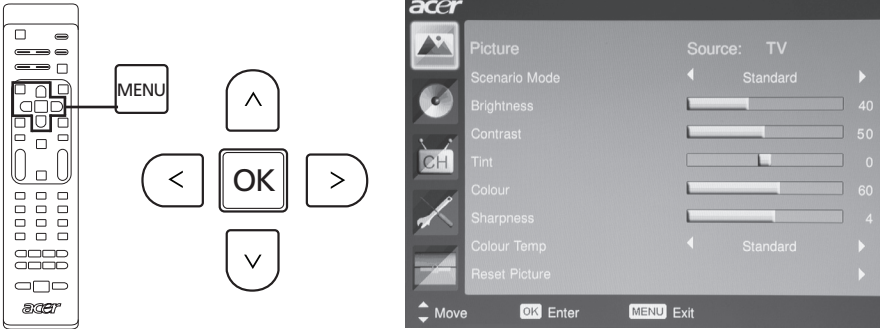

You can also interact with these menus using the right panel controls. Please see "Front panel view" on page 5 for details.

There are five main OSD menus. These are: Picture, Sound, Channel management, Settings and Advance. Use the following method to navigate these menus.		
1		Press the MENU button on the remote control or the MENU button on the control panel.
2		Select your desired menu by using the up and down directional keys to switch between the five menus.
3		Use the directional keys to interact with the menu. The up / down directions will scroll through the menu options, while left/right will adjust the different settings (for example, in the Picture menu, settings such as brightness, contrast, etc.). Press MENU to exit.

Adjusting the OSD settings

The OSD can be used for adjusting the settings of your LCD TV.

Press the **MENU** key to open the OSD. You can use the OSD to adjust the picture quality, audio settings, channel settings and general settings. For advanced settings, please refer to following page:

Adjusting the picture quality



- 1 Press the **MENU** key to bring up the OSD.
- 2 Using the directional keys, select **Picture** from the OSD. Then navigate to the picture element you wish to adjust.
- 3 Use the left or right keys to adjust the sliding scales.
- 4 The **Picture** menu can be used to adjust the current **Scenario Mode, Brightness, Contrast, Hue, Colour, Sharpness** and other image-related qualities.

Adjusting the sound settings



- 1 Press the **MENU** key to bring up the OSD.
- 2 Using the directional keys, select **Sound** from the onscreen display. Then navigate to the feature you wish to adjust.
- 3 Use the left or right keys to adjust the sliding scale. Press **OK** to save.
- 4 The **Sound** menu can also be used to adjust the the current **Scenario Mode, Treble, Bass, Balance, Steady Sound, Sound Effect** and other important sound-related settings.

Adjusting the channel management

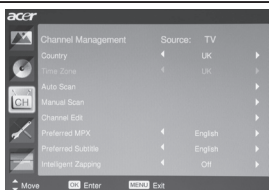

- 1 Press the **MENU** key to bring up the OSD.
- 2 Using the directional keys, select **Channel Management** from the OSD.
- 3 Use the directional keys to navigate the menus.
- 4 The **Channel management** menu can be used to adjust **Country, Time Zone, Auto Scan, Manual Scan, Channel Edit** and other important channel-related settings.

Adjusting the settings

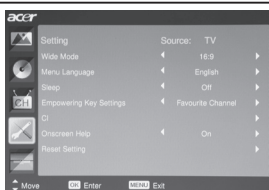

- 1 Press the **MENU** key to bring up the OSD.
- 2 Using the directional keys, select **Setting** from the OSD. Then navigate to the feature you wish to adjust.
- 3 The **Setting** menu can be used to adjust the screen **Wide Mode, Menu Language, Sleep, Empowering Key Settings** and other important settings.

Adjusting the advance settings

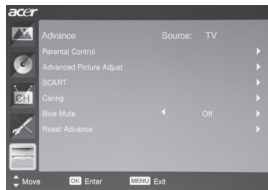

- 1 Press the **MENU** key to bring up the OSD.
- 2 Using the directional keys, select **Advance** from the OSD. Then navigate to the feature you wish to adjust.
- 3 The **Advance** menu can be used to adjust the **Parental Contal**, **Advanced Picture Adjust**, **SCART**, **Preferred Subtitle** and other important settings.



The options available on the OSD may vary depending on the TV signal source and model. Some digital options may not be available with an analog signal and vice versa.

Empowering Technology

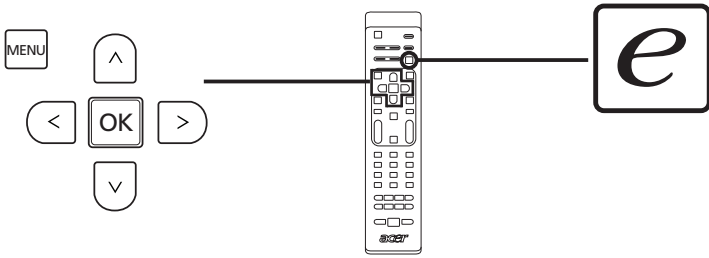

The Empowering Key opens up the Acer Empowering Technology functions.

Empowering Technology has choice is between Scenario mode and Favourite channel.

Set-up Empowering mode

To change your Empowering Key's default setting:

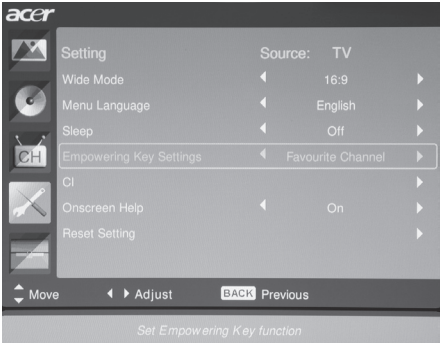
Set-up Empowering mode		
1		Press the MENU key on the remote control to bring up the OSD.
2		Use the directional keys to navigate and select  Setting .
3		 <p>Highlight Empowering key settings. Then, select the setting you wish to use.</p>
4		Press MENU to exit.

Default setting in different Empowering mode

Scenario mode in TV

Scenario mode has five preset viewing modes designed to give you the best picture quality when watching a particular kind of programme. There are five pre-defined audio and video settings for optimal enjoyment of the following scenarios: Standard TV, Movie, Sport, Concert, Game, NICE and User.



	Pressing the Empowering Key will toggle between the different modes.
---	---

Mode	Information
Standard	Standard mode allows you to watch your favourite channels with sharp, brilliant imagery via adaptive brightness and contrast adjustments, and listen to clear-sounding audio.
Movie	For comfortably enjoying movies at home, Movie mode displays dim scenes in clear detail; compensates for colour; and smoothly presents motion images. This is accomplished through optimal Gamma correction plus saturation, brightness and contrast adjustments. Movie mode makes the most of high-definition movie soundtracks.
Sport	Sport mode is suited for outdoor sports programmes, with accurate background depth and clear gradation between the bright, outdoor playing field and darker auditoriums. Sports mode also brilliantly enhances colours and presents swiftly moving pictures without residual images. All of this is achieved via specific Gamma corrections and saturation adjustments. Precise audio can be heard.
Concert	Concert mode places you in a virtual concert hall, opera house or other dim environment by means of adaptive brightness and contrast adjustments. Concert mode accentuates symphonic harmonies and the tenor audio range.
Game	Game mode carefully details the exquisite graphics of modern video games, providing lifelike entertainment while protecting your eyesight by adjusting brightness and contrast. What's more, Game mode provides a heightened audio experience.
NICE	NICE mode dynamically adjusts picture parameters according to the viewing distance set (see p21) and information transmitted with video signals. When this happens, a popup dialog will indicate that the display is being optimized.
User	User mode allows you to save your favourite video and audio settings.

Favourite channel mode in TV mode (default setting)

Favourite channel allows you to store your favourite TV channels and flick between them at the touch of a button.

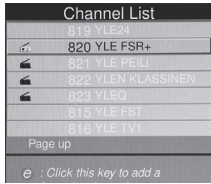



To set Favourite channel as the default, follow the steps described on this page.

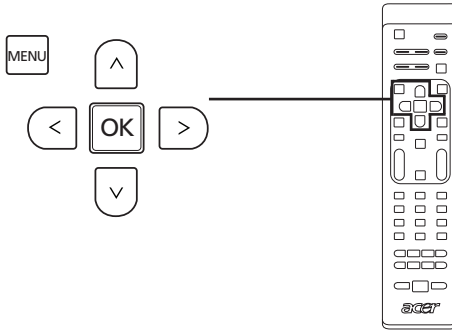

Storing favourite channels		
1		Press the CH LIST key on the remote control. This will bring up the channel list menu.
2		The current channel will be highlighted and press the Empowering Key to storing favourite channel.
3		Press the CH LIST key on the remote control to exit.
Viewing your favourite channels		
		On the remote control, if you press the Empowering Key , the TV will jump between the stored TV channels sequentially according to your list of favourites.

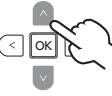
Advanced features

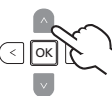
Advanced Picture Adjustment



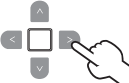

Advanced Picture Adjustment		
<p>1</p> 	<p>Press the Menu key from the remote control hand set, to invoke the OSD (On Screen Display).</p>	
<p>2</p> 		<p>Using the directional keys to navigate, select Advance from the OSD. Scroll to 'Advanced Picture Adjust' sub-menu to adjust picture settings.</p>
<p>3</p> 		<p>Using the directional keys, to navigate through 'Noise Reduction', 'Back Light Control', 'ACM' or 'Viewing Distance'.</p>

4		<ul style="list-style-type: none">* Noise Reduction: This function filters noise from a signal. You can set to Off, Low, Medium, High or Auto depending on your preference.* Back Light Control: This setting adjusts the picture displays 'backlight / brightness'. Use the Left or Right direction keys to adjust this feature.* ACM: This function (Adaptive Contrast Management) automatically adjusts picture contrast, depending on the brightness of the video content. You can turn this feature either to 'on' or 'off'.* Viewing Distance: Use the Left or Right direction keys to set the distance between you and the screen. This will affect how NICE mode (see page 19) adjusts the picture settings.
5		Press MENU to exit.

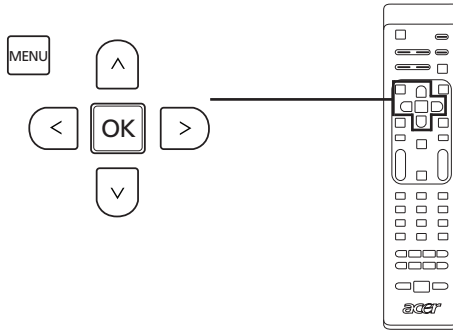
Steady Sound

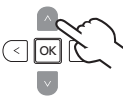
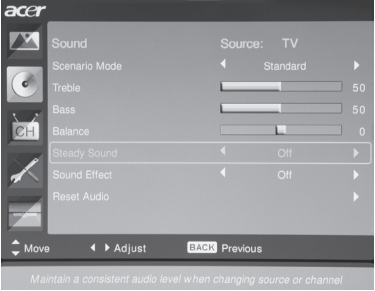
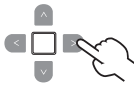

Steady Sound	
1	 <p>Press the Menu key from the remote control hand set, to invoke the OSD (On Screen Display).</p>
2	  <p>Using the directional keys, navigate to and select Sound from the OSD. Navigate to 'Steady Sound' to adjust settings.</p>
3	 <p>This function prevents sudden changes in the audio output level. If this function is selected as 'On,' volume levels will be consistent when switching between input sources and changing channels.</p>
4	 <p>Press MENU to exit.</p>

Channel Edit

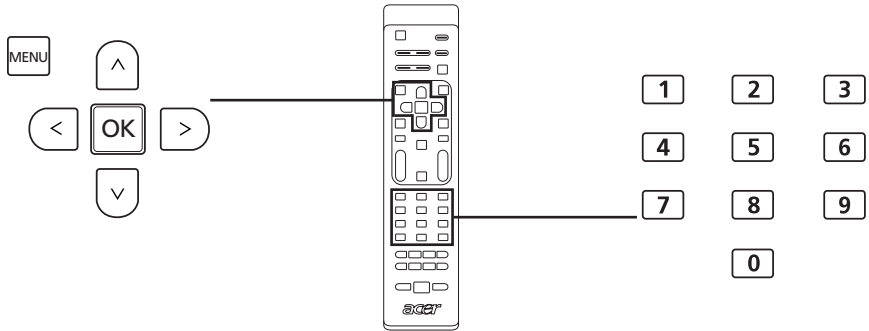

Channel Edit		
1		Press the Menu key from the remote control hand set, to invoke the OSD (On Screen Display).
2		<p>Using the directional keys, navigate to and select Channel Management. From this sub menu, select Channel Edit to adjust Channel settings.</p>
3		<p>Using the directional keys, to navigate through options 'Edit', 'Skip', 'Reorder' or 'Decoder'.</p>

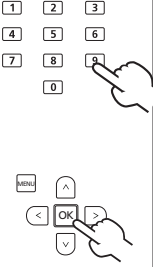
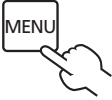
4		<p>* Edit: You can set the Channel Index and Channel Name here. Use the directional keys to edit the channel index or channel name column. You can use the number keys to enter a number or alphabetic character (by toggling number keys)* and press OK to confirm or Menu to cancel.</p> <p>* Skip: Please use the directional keys to select which channels you want to skip and press OK to confirm. These channels will automatically be skipped when the CH key is used to select channels later on. However, you can still manually select these channels.</p> <p>* Reorder: Please use the directional keys to select which channels you want to reorder and swap. These two channels will change order in the channel list.</p> <p>* Decoder: Use the directional keys to turn decoding of encrypted channels on or off (only works if a decoder is connected to the SCART port).</p>
5		<p>Press MENU to exit.</p>



You can toggle number keys to enter alpha-numeric characters as follows:

Number 1: 1, -

Number 2: 2, a, b, c, A, B, C

Number 3: 3, d, e, f, D, E, F

Number 4: 4, g, h, i, G, H, I

Number 5: 5, j, k, l, J, K, L

Number 6: 6, m, n, o, M, N, O

Number 7: 7, p, q, r, s, P, Q, R, S

Number 8: 8, t, u, v, T, U, V

Number 9: 9, w, x, y, z, W, X, Y, Z

Number 0: 0, (space)

Reorder for channels

The first time you completed the setup wizard, all available channels were listed. If you need to reorder for new channels, please follow the steps below:

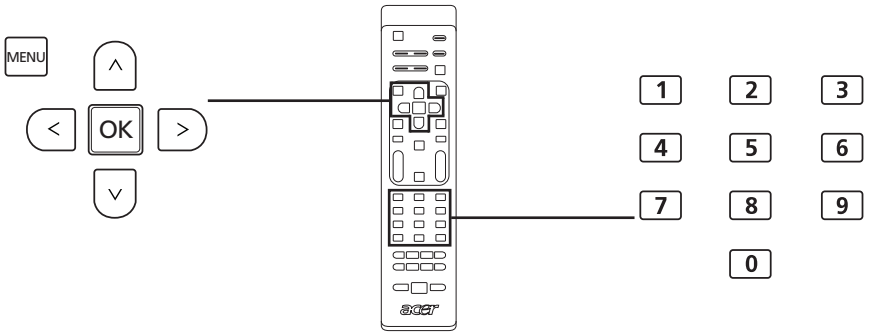

Reordering for channels		
1		Press the MENU key on the remote control to bring up the OSD.
2		Use the directional keys to navigate and select Channel Management. Then select Channel Edit .
3	 	Highlight Reorder . Then, select the channel you wish to reorder and press OK to confirm. Move to the right channel number and press OK to reconfirm.
4		Press MENU to exit.

Auto scan for channels

The first time you completed the setup wizard, all available channels were listed. If you need to re-scan for new channels, please follow the steps below:

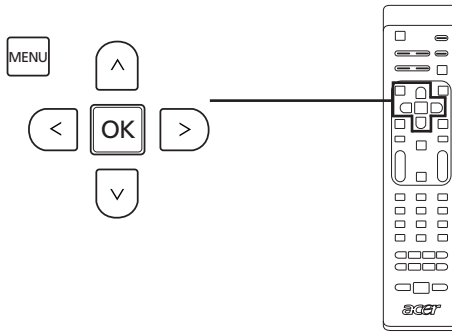

Scanning for channels		
1		Press the MENU key on the remote control to bring up the OSD.
2		Use the directional keys to navigate and select Channel Management.
3		Highlight Auto Scan . Then, select Start and press OK to begin.
4		

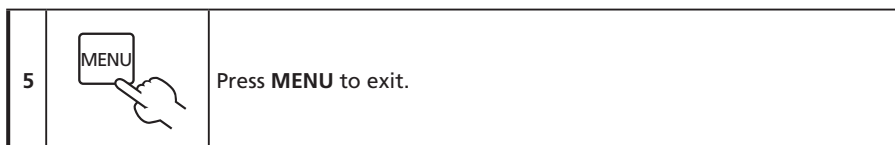

Channel scan ordering

1. If your Country supports 'LCN' (logical channel numbers)*, via Digital Channel broadcasting, these channels will always have the highest priority.
2. If your Country does not support DTV LCN, scanned channel numbers will start from ch801 in frequency of order.
3. ATV channels will start from ch901, and follow the current ATV channel sorting rules. If the highest DTV number is larger than 901, ATV channels will be sorted starting from chX01 (X=10, 11...) depending on the LCN channel's digit count.
4. If there is any LCN conflict, either between ATV LCN and DTV LCN, the conflicting channel will be stored in a channel location after ch800.
5. The TV will automatically detect new channels, and if a new channel is detected it will place the LCN channel in its LCN position. If there's no LCN, or the channel position has already been occupied, the channel will be located at the end of the non-LCN channel list.
6. If there is no digital service after auto-scan, the analog channel may be located from ch001. Referring to rule 3, the X in this case will be 0.



In some European countries, the TV broadcast will embed the LCN (logical channel number) in the DTV signal to allocate a channel number.

Intelligent Zapping



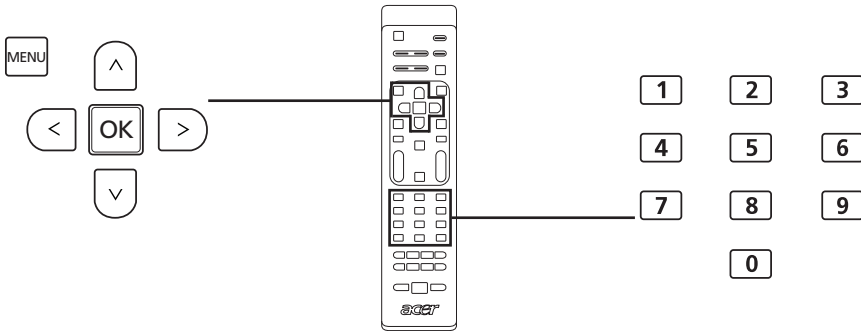

Intelligent Zapping changes the action of the **Recall** button when channel-surfing. When you click through channels and then press the **Recall** key, it will return to the last channel viewed for longer than the set time, ignoring other channels.

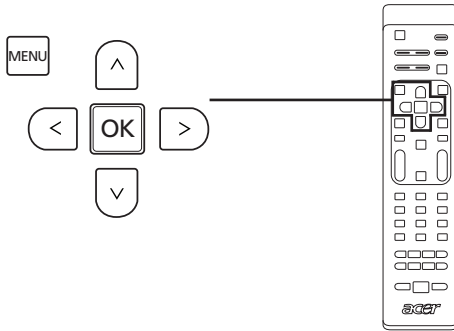

Intelligent Zapping		
1		Press the MENU key on the remote control to bring up the OSD.
2		Use the directional keys to navigate and select Channel Management.
3		<p>Select Intelligent Zapping and then use the directional keys to set the time.</p>
4		Press MENU to exit.

Blue Mute

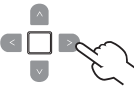

Blue Mute	
1	 <p>Press the Menu key from the remote control hand set, to invoke the OSD (On Screen Display).</p>
2	  <p>Using the directional keys, navigate to and select Advance from the OSD. Navigate to Blue Mute to adjust this setting.</p>
3	 <p>If Blue Mute is selected as being 'On', a blue screen will be displayed if the TV is unable to detect a signal. If Blue Mute Off is selected, a black screen will be displayed when no signal is detected.</p>
4	 <p>Press MENU to exit.</p>

Parental Control

Locking TV content



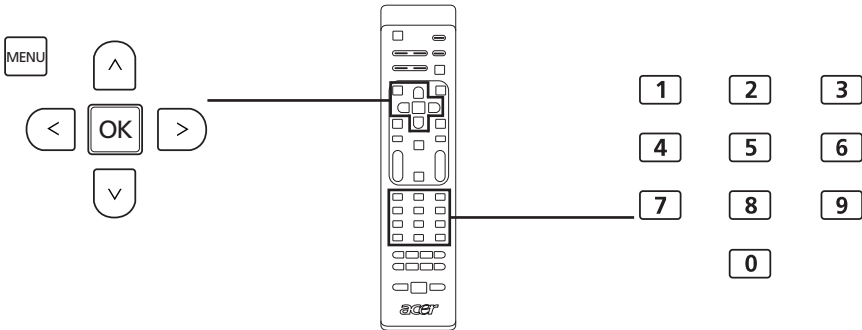

Parental control is a handy feature that can block all TV sources.

Parental control allows you to enter a password and effectively stop anyone without the password from watching TV.

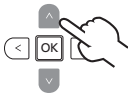

To enable this feature:

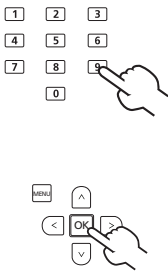
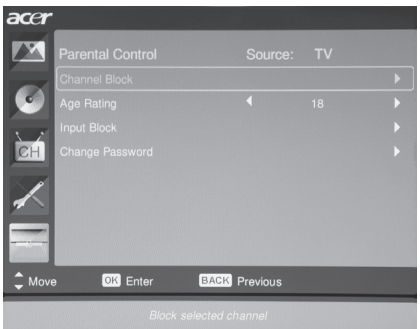
Setting a password		
1		Press the MENU key on the remote control to bring up the OSD.
2		 <p>Using the directional keys, navigate to and select Advance from the OSD. Navigate to the Parental Control menu. Then enter Password. (see note)</p>
3		Enter a four-digit password.
4		Press MENU to exit.

Locking your TV			
1		Press the MENU key on the remote control to bring up the OSD.	
2		Using the directional keys , navigate to and select  Advance from the OSD. Navigate to the Parental Control menu.	
3			Enter your Password. Then, select Channel block , Age Rating , Input block or Change Password for further settings. (see note)
4		Press MENU to exit.	



The default password for this TV is "0000." First enter "0000" when you want to change the password. If you forget your password, please enter 6163 to reset.

TV ratings (for digital TV mode)

Most digital TV allows you to block content according to rating systems. The rating system available is dependent on region.

DVB ratings

The DVB system rates content by age. The categories are increase by increments of one year from 4 to 18 years of age.

The categories are as follows:

Rating	Description
4 years	4 years and under
5 years	5 years and under
⋮	⋮
17 years	17 years and under
18 years	18 years and under

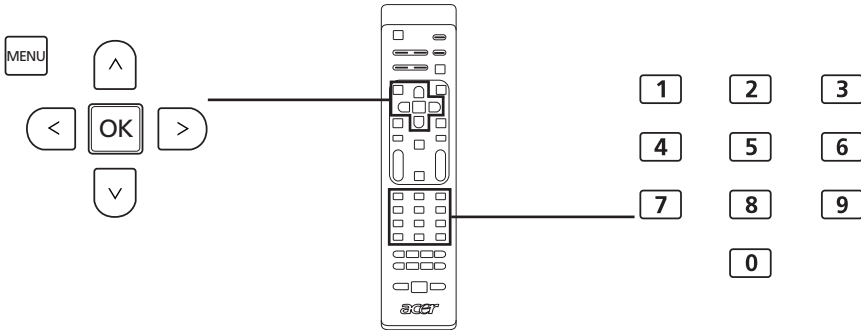

Like other rating systems, when you lock a category, all the more restricted categories will automatically be blocked.

Setting or changing the ratings

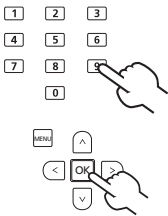

To set or change your TV ratings settings:

1		Navigate to the channel you wish to manage and make sure that the channel is unlocked.
2		Press the MENU key on the remote control to bring up the OSD.
3		Using the directional keys , navigate to and select Advance from the OSD. Navigate to the Parental Control menu.

4	 <p>The diagram shows a remote control keypad with a grid of buttons: 1, 2, 3; 4, 5, 6; 7, 8, 9; 0. Below the grid are buttons for MENU, a triangle key, a left arrow key, OK, a right arrow key, and a checkmark key. A hand is shown pointing to the '9' key in the top diagram, and another hand is shown pointing to the 'OK' key in the bottom diagram.</p>	<p>Enter your Password. Then, select Age Rating and using the directional keys to set the age-rating.</p> <p>Press OK to confirm your settings. (see page 31 note)</p>
5	 <p>The diagram shows a hand pointing to a button labeled 'MENU' on a remote control.</p>	<p>Press MENU to exit.</p>

Channel list

Channel list allows you to quickly find the TV channel you are searching for.

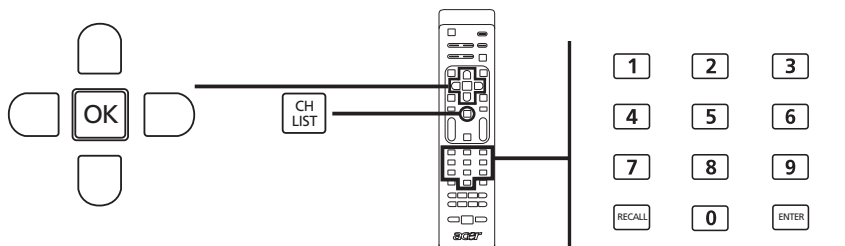

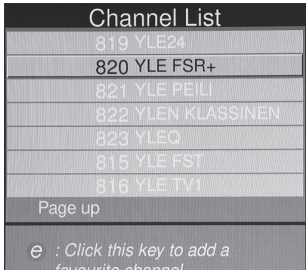
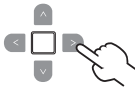
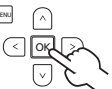
To open the channel list feature:		
1		Press the CH LIST key on the remote control. This will bring up the channel list menu.
2		The current channel will be highlighted.
3		Use the directional keys to navigate the list and select the channel you wish to watch.
4		Press OK to confirm.

Electronic programme guide

The electronic programme guide (EPG) is an onscreen service available on digital TV that provides information about scheduled broadcast programmes on all channels by time, title, channel and genre.

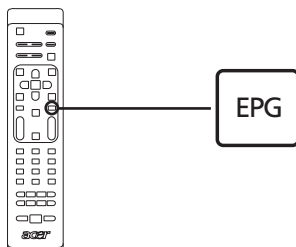

EPG screen

There are four main areas of the EPG screen:

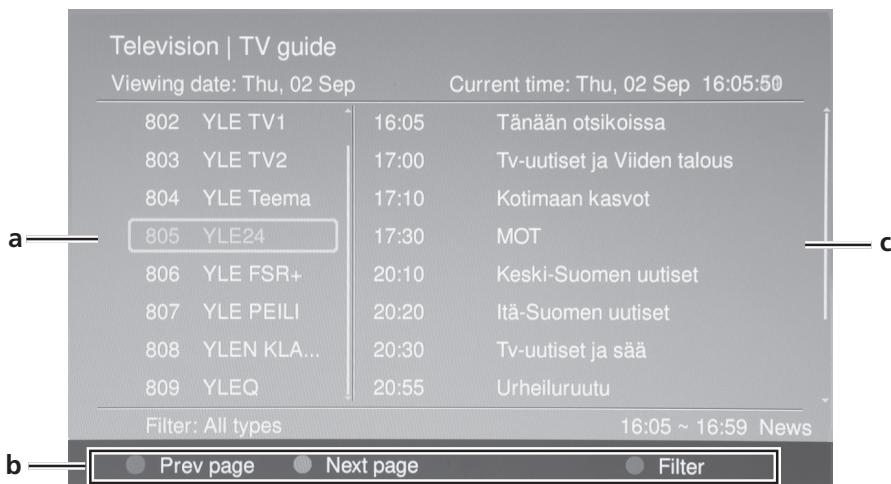

a. Content area

The content area shows the date, channel and programme.

Use the directional keys to navigate between the items in the content area.

Highlight a new programme to display the programme in the introduction areas. Press the **BACK** key to exit.

b. Indication

This area of the EPG indicates which shortcut keys can be used while on an EPG screen.

c. Programme introduction area

A short description of the highlighted programme is located at the bottom right-hand corner of the EPG page; lengthy descriptions will be cut short using "..." to indicate extra text.

Highlight the introduction to view the whole introduction section on a separate page. Press the **BACK** key to exit.

Navigating the EPG (for Digital TV mode)

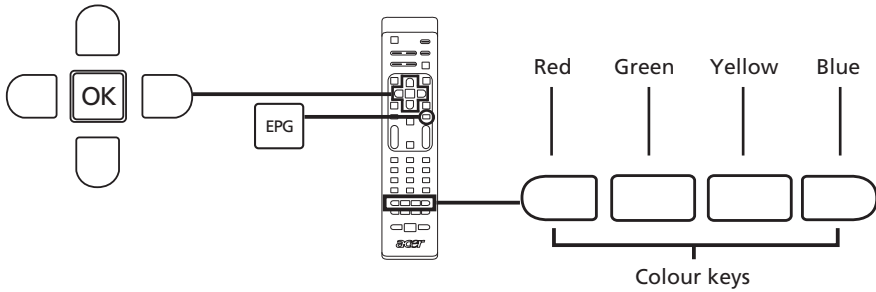

1		Press the EPG key on the remote control.
2		Use the directional keys to navigate around the EPG menu and press OK to select your highlighted option.

short-cuts	EPG features
Red	Press the red key to view the previous day's list of channels.
Green	Press the green key to view the next day's list of channels.
Yellow	Press the yellow key to view details of the selected item.
Blue	Press the blue key to go to the Type filter page. The Type filter feature can help you to select a certain category of programmes that you may wish to watch.

Sound effects

Your Acer LCD TV is equipped with high-quality sound specifications to ensure that you enjoy the best audio experience possible.

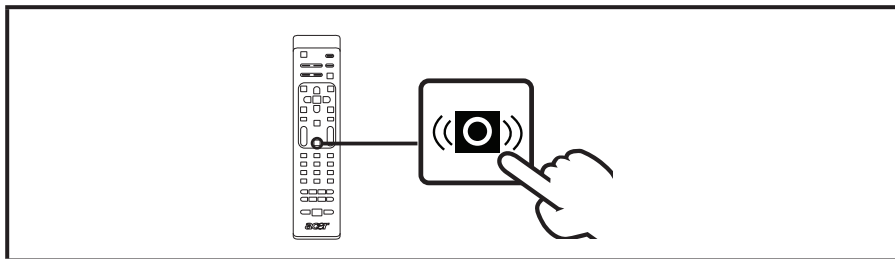

Widescreen display mode

Your Acer LCD TV has a special widescreen mode that allows you to toggle between Wide detect, 4:3, 16:9, Panorama, and Letterbox 1, 2 and 3 type views.

Press the **WIDE** key on the remote control to toggle the display between the four wide modes.

Wide mode

The Acer LCD contains various widescreen modes, including Wide detect, 4:3, 16:9, Panorama, and Letterbox 1, 2 and 3.

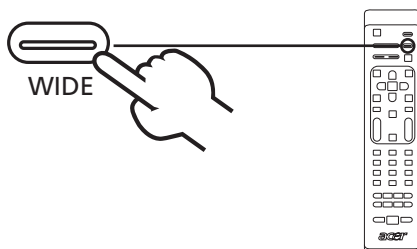

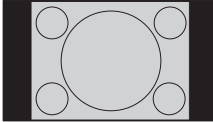
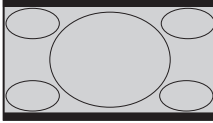
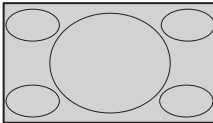
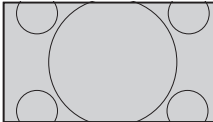
Wide detect	In this mode, TV will auto detect picture source and fit in suitable size.
4:3	For 4:3 standard pictures. A side bar appears on each side.
	
16:9	In this mode, the screen will display 16:9 standard pictures.
	
Panorama	In this mode, the picture is progressively stretched toward each side of the screen.
	
Letterbox 1, 2, and 3	In this mode, the picture is enlarged linearly to fit the screen. The top and bottom portions of the picture may be cut off.
	

Troubleshooting

Before you call the Acer service center, please check the following items:

Here is a list of possible situations that may arise during the use of your LCD TV. Easy answers and solutions are provided for each.

There is no picture or sound.

- Make sure the power cord is properly inserted in the power outlet.
- Make sure the input mode is correctly set by your selected input.
- Make sure the antenna at the rear of the TV is properly connected.
- Make sure the main power switch is turned on.
- Make sure the volume is not set to minimum or the sound is not set to mute.
- Make sure the headphones are not connected.
- Reception other than those of broadcasting stations can be considered.

Picture is not clear.

- Make sure the antenna cable is properly connected.
- Consider whether your TV signal is being properly received.
- Poor picture quality can occur due to a VHS camera, camcorder, or other peripheral being connected at the same time. Switch off one of the other peripherals.
- The 'ghost' or double image may be caused by obstruction to the antenna due to high-rise buildings or hills. Using a highly directional antenna may improve the picture quality.
- The horizontal dotted lines shown on the pictures may be caused by electrical interference, e.g., hair dryer, nearby neon lights, etc. Turn off or remove these.

Picture is too dark, too light or tinted.

- Check the colour adjustment.
- Check the brightness setting.
- Check the sharpness function.
- The fluorescent lamp may have reached the end of its service life.

Remote control does not work.

- Check the batteries of the remote control.
- Make sure the remote sensor window is not under strong fluorescent lighting.
- Try to clean the remote control sensor lens on the TV with a soft cloth.
- Use the buttons (hotkeys) on the TV before the remote control works.

If the above suggestions do not solve your technical issue, please refer to the warranty card for service information.

PC Input Signal Reference Chart

AT2355/AT2356:

	Resolution	Horizontal Frequency (kHz)	Vertical Frequency (Hz)	Standard
1	640 x 480	31.5	60.0	VGA
2	640 x 480	37.9	72.8	VGA
3	640 x 480	37.5	75.0	VGA
4	640 x 480	35.0	66.7	MAC
5	720 x 400	31.5	70.1	VESA
6	800 x 600	35.2	56.3	SVGA
7	800 x 600	37.9	60.3	SVGA
8	800 x 600	46.9	75.0	SVGA
9	832 x 624	49.7	74.6	MAC
10	1024 x 768	48.4	60.0	XGA
11	1024 x 768	56.5	70.1	XGA
12	1024 x 768	60.0	75.0	XGA
13	1152 x 864	67.5	75.0	VESA
14	1280 x 1024	64.0	60.0	SXGA
15	1280 x 1024	80.0	75.0	SXGA
16	1280 x 720	45.0	59.9	VESA
17	1280 x 768	47.8	59.9	VESA
18	1680 x 1050	65.3	60.0	WSXGA+
19	1920 x 1080	67.5	60.0	VESA

AT2055/AT2056:

	Resolution	Horizontal Frequency (kHz)	Vertical Frequency (Hz)	Standard
1	640 x 480	31.5	60.0	VGA
2	640 x 480	37.9	72.8	VGA
3	640 x 480	37.5	75.0	VGA
4	640 x 480	35.0	66.7	MAC
5	720 x 400	31.5	70.1	VESA
6	800 x 600	35.2	56.3	SVGA
7	800 x 600	37.9	60.3	SVGA
8	800 x 600	46.9	75.0	SVGA
9	832 x 624	49.7	74.6	MAC
10	1024 x 768	48.4	60.0	XGA
11	1024 x 768	56.5	70.1	XGA
12	1024 x 768	60.0	75.0	XGA
13	1152 x 864	67.5	75.0	VESA
14	1280 x 720	45.0	59.9	VESA
15	1280 x 768	47.8	59.9	VESA
16	1600 x 900	60.0	59.9	VESA



-
- 1). The PC input does not support Sync on Green or Composite Sync.
 - 2). The PC input does not support interlaced signals.

Product specifications

Model	AT2355	AT2356	AT2055	AT2056
Panel spec				
Resolution (pixels)	1920 x 1080		1600 x 900	
Brightness (tpe.)	300 nit			
Contrast Ratio (tpe.)	1000 : 1			
Dynamic Contrast Ratio (max.)	20000 : 1			
Viewing angle (tpe.)	H: 170° ; V:160°			
Response (tpe.)	5 ms (Gray to Gray)			
Power supply				
Input	100 to 240 V AC (50/60 Hz)			
Max. power consumption	50 W	50 W	50 W	50 W
Power saving	<1 W			
Mechanical				
Dimensions (W x H x D mm)	570 x 420 x 190		503 x 380 x 190	
Weight (kg)	5.1		4.95	
Weight (lbs.)	11.25		10.91	
Gross weight (Kg)	7.9		6.5	
Gross weight (lbs)	16.54		14.33	
Analog TV system				
Colour system	PAL, SECAM			
Sound system	B/G/D/K/I/L/L'			
Stereo system	NICAM/A2			
Subtitle	Teletext 1.5 (1000 pages)			
Digital TV system				
Digital TV standard	DVB-T SD	DVB-T HD (H.264)	DVB-T SD	DVB-T HD (H.264)
Sound system	ISO11172-3 layer1 & layer2 32KHz,44.1KHz,48KHz			
Stereo system	PCM / MPEG (Layer I & II) Stereo 32 / 44.1 / 48KHz	PCM / MPEG (Layer I & II) Stereo 32 / 44.1 / 48KHz, Dolby AC-3	PCM / MPEG (Layer I & II) Stereo 32 / 44.1 / 48KHz	PCM / MPEG (Layer I & II) Stereo 32 / 44.1 / 48KHz, Dolby AC-3
Frequency	7/8 MHz			

Terminal		
Analog/ Digital Tuner In	Hybird	
SCART 1	CVBS(In/Out), RGB(In), Audio R/L	
Component in	YPbPr, Audio (R/L)	
AV-in	CVBS, S Video, Audio (R/L)	
HDMI 1	Yes (HDMI 1.3)	
HDMI 2	Yes (HDMI 1.3)	
PC D-sub in	Yes	
PC audio-in	Yes	
SPDIF out	Yes (Coaxial)	
Headphone out	Yes	
Service Port	Yes	
Resolution		
HDMI	480i/p, 576i/p, 720p, 1080i, 1080p	480i/p, 576i/p, 720p, 1080i
Audio system		
Speakers	5W + 5 W	